

Technical data sheet - Actuator sensor interface

M12 panel jack



Identification	Type	STGE-M12 5pol. 0,5m Litze
	Part-No.	490068
Description	M12 connectors panel mounted using M16 thread Male / female - A coded 0.5 m TPE wire	
Technical data		
Nominal voltage	AC/DC 24 V	
Nominal voltage range	max. 60 V	
Rated current	4 A	
Pol number	5	
Cable length (m)	0.5 m	
Cable length	0.5 m	
Coding	A	
General		
Form	M12 × 1, male	
Rated insulation voltage (EN 50178)	60 V	
Test voltage	1.5 kV	
Pollution degree	3	
Insulation resistance	≥100 MΩ	

30.01.2017 – Subject to technical modification

Part-No. 490068

USA: LUTZE INC.

13330 South Ridge Drive • Charlotte, NC 28273, USA
Tel. +1 (704) 504-0222 • Fax +1 (704) 504-0223
www.lutze.com • info@lutze.com

United Kingdom: LÜTZE Ltd.

Unit 3, Sandy Hill Park
Sandy Way, Amington • GB-Tamworth, Staffs B77 4DU
Tel. +44 (0)1827 31333-0 • Fax +44 (0)1827 31333-2
www.lutze.com • sales.gb@lutze.co.uk



SYSTEMATIC TECHNOLOGY

Technical data sheet - Actuator sensor interface

Contact resistance	$\leq 3 \text{ m}\Omega$
Class of flammability according to UL 94	V0
Protection class	IP 67, in screwed condition
Housing material	Zinc die-casting, nickel-plated
Contact material	CuZn, gold-plated
Thread material	CuSn nickel plated
Cable construction	Individual wires: $0.34 \text{ mm}^2(7 \times 0.25 \text{ mm}) / 0.25 \text{ mm}^2(14 \times 0.15 \text{ mm})$
Conductor insulation	TPE-wire, colored
Cable diameter	0.34 mm^2 : 1.25 mm / 0.25 mm^2 : 1.15 mm
Storage temperature range	-40 °C ... 90 °C
Temperature range connector	-25 °C – 90 °C
Mechanical service life	>100 insertion cycles
Cross section	5x0.34
Weight (kg/piece)	0.021
Termination	Thread M16
PU	1

Dimensions

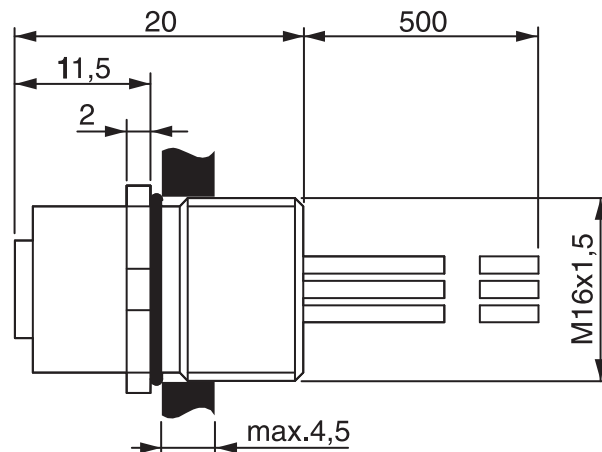

30.01.2017 – Subject to technical modification

Part-No. 490068

USA: LUTZE INC.

13330 South Ridge Drive • Charlotte, NC 28273, USA
Tel. +1 (704) 504-0222 • Fax +1 (704) 504-0223
www.lutze.com • info@lutze.com

United Kingdom: LÜTZE Ltd.

Unit 3, Sandy Hill Park
Sandy Way, Amington • GB-Tamworth, Staffs B77 4DU
Tel. +44 (0)1827 31333-0 • Fax +44 (0)1827 31333-2
www.lutze.com • sales.gb@lutze.co.uk



SYSTEMATIC TECHNOLOGY

Technical data sheet · Actuator sensor interface

Mounting diagram

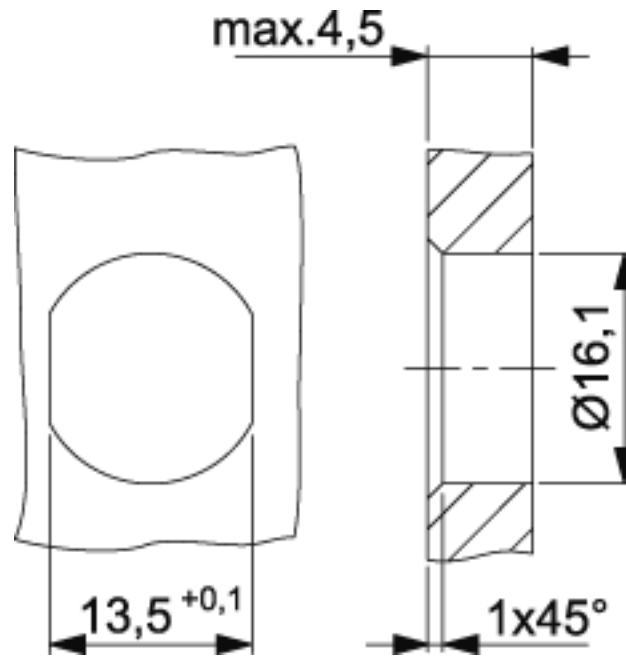

Pin layout



Accessories

Accessories	Article number	Type	PU
Counter nut M16	600361	GMS M 16 × 1.5	100

30.01.2017 – Subject to technical modification

Part-No. 490068

USA: LUTZE INC.

13330 South Ridge Drive · Charlotte, NC 28273, USA

Tel. +1 (704) 504-0222 · Fax +1 (704) 504-0223

www.lutze.com · info@lutze.com

United Kingdom: LÜTZE Ltd.

Unit 3, Sandy Hill Park

Sandy Way, Amington · GB-Tamworth, Staffs B77 4DU

Tel. +44 (0)1827 31333-0 · Fax +44 (0)1827 31333-2

www.lutze.com · sales.gb@lutze.co.uk

Technical data sheet - Actuator sensor interface

Comments

Connection assignment

Pole / wire color:

1/ BN (brown)
2/ WH (white)
3/ BU (blue)
4/ BK (black)

1/ BN (brown)
2/ WH (white)
3/ BU (blue)
4/ BK (black)
5/ GY (grey)

1/ WH (white)
2/ BN (brown)
3/ GN (green)
4/ YE (yellow)
5/ GY (grey)
6/ PK (pink)
7/ BU (blue)
8/ RD (red)

30.01.2017 – Subject to technical modification

Part-No. 490068

USA: LUTZE INC.

13330 South Ridge Drive • Charlotte, NC 28273, USA
Tel. +1 (704) 504-0222 • Fax +1 (704) 504-0223
www.lutze.com • info@lutze.com

United Kingdom: LÜTZE Ltd.

Unit 3, Sandy Hill Park
Sandy Way, Amington • GB-Tamworth, Staffs B77 4DU
Tel. +44 (0)1827 31333-0 • Fax +44 (0)1827 31333-2
www.lutze.com • sales.gb@lutze.co.uk



SYSTEMATIC TECHNOLOGY