



Identification	Type Part-No.	KUGE4-M12 /ET 2,0M PUR 490084
Description	M12 panel connector using M16 thread Including Ethernet Cable Female - D coded (Ethernet Cat.5e) Cable, shielded, halogen free	
Technical data	Nominal voltage AC/DC 24 V Nominal voltage range max. 60 V Rated current 4 A Number of terminations 4 Cable length (m) 2.0 m Coding D Shielding 360°	
General	Form M12 × 1, female Rated insulation voltage (EN 50178) 250 V Test voltage 2.5 kV Pollution degree 3 Insulation resistance ≥100 MΩ	

10.08.2014 – Subject to technical modification

Part-No. 490084

USA: LUTZE INC.

13330 South Ridge Drive • Charlotte, NC 28273, USA
Tel. +1 (704) 504-0222 • Fax +1 (704) 504-0223
www.lutze.com • info@lutze.com

United Kingdom: LÜTZE Ltd.

Unit 3, Sandy Hill Park
Sandy Way, Amington • GB-Tamworth, Staffs B77 4DU
Tel. +44 (0)1827 31333-0 • Fax +44 (0)1827 31333-2
www.lutze.com • sales.gb@lutze.co.uk



Technical data sheet - Actuator sensor interface

Contact resistance	$\leq 3 \text{ m}\Omega$
Class of flammability according to UL 94	HB
Protection class	IP 67, in screwed condition
Housing material	Zinc die-casting, nickel-plated
Contact material	CuZn, gold-plated
Thread material	CuSn nickel plated
Gasket	NBR
Cable construction	2 x 2 x AWG 26/7
Conductor insulation	PE PUR sea blue
Cable diameter	6.7 mm
Bending radius	15 x cable diameter
Storage temperature range	-40 °C – 90 °C
Temperature range connector	-25 °C – 90 °C
Temperature range cable fixed	-20 °C – 70 °C
Temperature range cable moving	0 °C – 50 °C
Weight (kg/piece)	0.133
PU	10

Dimensions

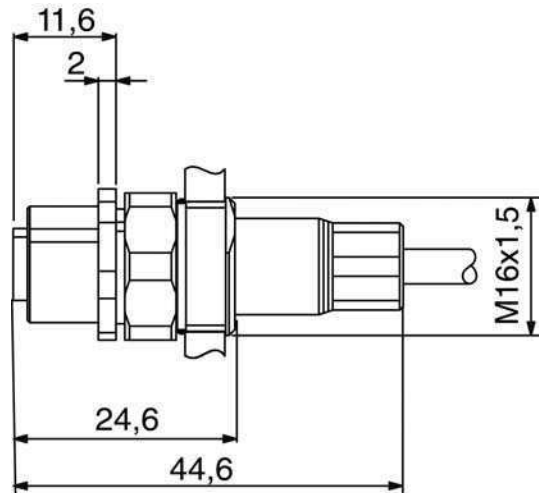

10.08.2014 – Subject to technical modification

Part-No. 490084

USA: LUTZE INC.

13330 South Ridge Drive • Charlotte, NC 28273, USA

Tel. +1 (704) 504-0222 • Fax +1 (704) 504-0223

www.lutze.com • info@lutze.com

United Kingdom: LÜTZE Ltd.

Unit 3, Sandy Hill Park

Sandy Way, Amington • GB-Tamworth, Staffs B77 4DU

Tel. +44 (0)1827 31333-0 • Fax +44 (0)1827 31333-2

www.lutze.com • sales.gb@lutze.co.uk



SYSTEMATIC TECHNOLOGY

Technical data sheet - Actuator sensor interface

Pin layout

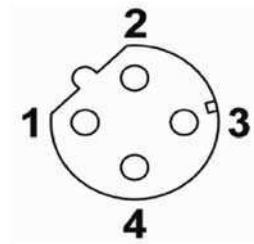

Accessories

Accessories	Article number	Type	PU
Counter nut M16	600361	GMS M 16 × 1.5	100

Comments

Connection assignment

Pole / wire colour:

- 1/ YE (yellow)
- 2/ WH (white)
- 3/ OG (orange)
- 4/ BU (blue)

10.08.2014 – Subject to technical modification

Part-No. 490084

USA: LUTZE INC.

13330 South Ridge Drive • Charlotte, NC 28273, USA
Tel. +1 (704) 504-0222 • Fax +1 (704) 504-0223
www.lutze.com • info@lutze.com

United Kingdom: LÜTZE Ltd.

Unit 3, Sandy Hill Park
Sandy Way, Amington • GB-Tamworth, Staffs B77 4DU
Tel. +44 (0)1827 31333-0 • Fax +44 (0)1827 31333-2
www.lutze.com • sales.gb@lutze.co.uk