

Technical data sheet - Actuator sensor interface

USB-panel connector



Identification	Type	USB-3.0 A/A F/M 1,5m PVC
	Part-No.	490113.0150

Description

USB 3.0 panel connector with M22 thread for front installation
USB connector Type A on straight USB plug Type A with PVC cable
Type: USB-3.0 A/A

Technical data

Nominal voltage	AC/DC 5 V
Nominal voltage range	max. 30 V
Rated current	900 mA
Pol number	9
Cable length (m)	1.5 m
Cable length	1.5 m
Transfer rate	5 Gbit/s
USB standard	3.0
Contact type	1 : 1
Shielding	yes

General

Form	USB-A
Pollution degree	3

30.01.2017 – Subject to technical modification

Part-No. 490113.0150

USA: LUTZE INC.

13330 South Ridge Drive • Charlotte, NC 28273, USA
Tel. +1 (704) 504-0222 • Fax +1 (704) 504-0223
www.lutze.com • info@lutze.com

United Kingdom: LÜTZE Ltd.

Unit 3, Sandy Hill Park
Sandy Way, Amington • GB-Tamworth, Staffs B77 4DU
Tel. +44 (0)1827 31333-0 • Fax +44 (0)1827 31333-2
www.lutze.com • sales.gb@lutze.co.uk



SYSTEMATIC TECHNOLOGY

Technical data sheet - Actuator sensor interface

Insulation resistance	>100 M Ω
Contact resistance	<30 m Ω
Protection class	IP 65 and UL NEMA Typ 12 65 in closed and IP 20 in inserted condition
Housing material	Female: PA; Male: PVC, Coverage: TPU
Contact material	CuSn, gold-plated
Field installation	Front plate cutout D=22.5mm
Cable construction	(2×AWG24 + 1×2×AWG28 + 2×(1×2×AWG28)St)StC
Cable jacket	PVC black
Cable diameter	6.1 mm
Bending radius	6 x cable diameter
Operation temperature range	-5 °C – 70 °C
Temperature range cable fixed	-25 °C – 80 °C
Temperature range cable moving	-5 °C – 70 °C
Dimension	(D×T) 29.5 × 45 mm, installation depth appr. 70 mm
Mechanical service life	1500 insertion cycles
Weight (kg/piece)	0.094
Approvals	cULus
PU	1

Dimensions

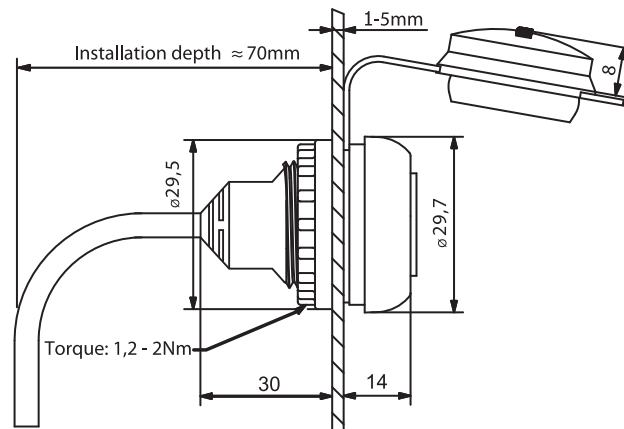

30.01.2017 – Subject to technical modification

Part-No. 490113.0150

USA: LUTZE INC.

13330 South Ridge Drive • Charlotte, NC 28273, USA
Tel. +1 (704) 504-0222 • Fax +1 (704) 504-0223
www.lutze.com • info@lutze.com

United Kingdom: LÜTZE Ltd.

Unit 3, Sandy Hill Park
Sandy Way, Amington • GB-Tamworth, Staffs B77 4DU
Tel. +44 (0)1827 31333-0 • Fax +44 (0)1827 31333-2
www.lutze.com • sales.gb@lutze.co.uk



SYSTEMATIC TECHNOLOGY

Technical data sheet · Actuator sensor interface

PIN assignment

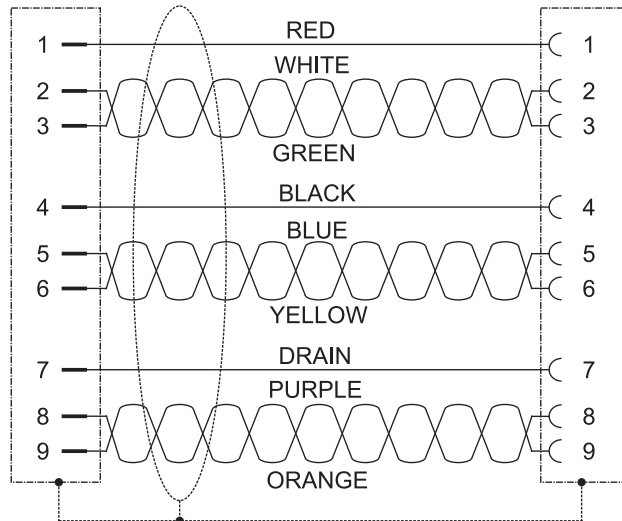

Mounting diagram

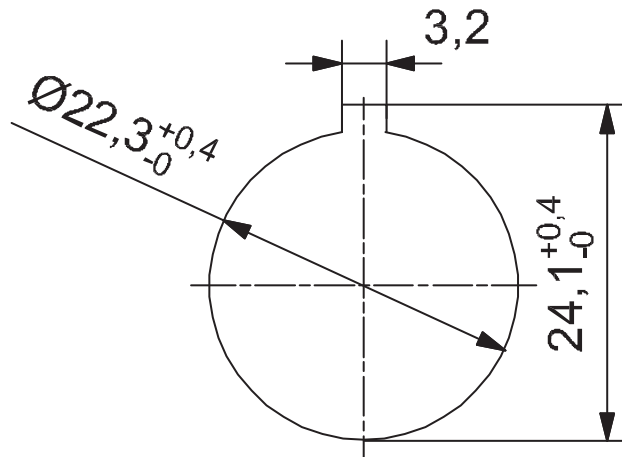

30.01.2017 – Subject to technical modification

Part-No. 490113.0150

USA: LUTZE INC.

13330 South Ridge Drive · Charlotte, NC 28273, USA

Tel. +1 (704) 504-0222 · Fax +1 (704) 504-0223

www.lutze.com · info@lutze.com

United Kingdom: LÜTZE Ltd.

Unit 3, Sandy Hill Park

Sandy Way, Amington · GB-Tamworth, Staffs B77 4DU

Tel. +44 (0)1827 31333-0 · Fax +44 (0)1827 31333-2

www.lutze.com · sales.gb@lutze.co.uk



SYSTEMATIC TECHNOLOGY

Technical data sheet - Actuator sensor interface

Front view

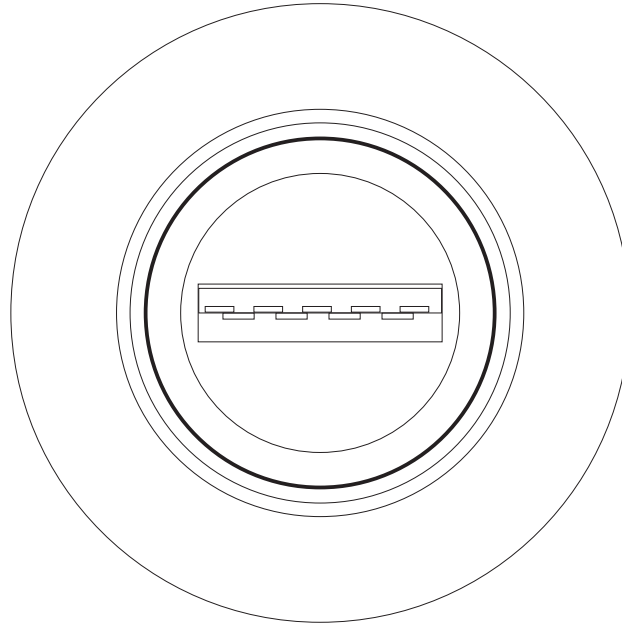

Symbols



Comments

Included in the delivery: captive safety cap

30.01.2017 – Subject to technical modification

Part-No. 490113.0150

USA: LUTZE INC.

13330 South Ridge Drive • Charlotte, NC 28273, USA

Tel. +1 (704) 504-0222 • Fax +1 (704) 504-0223

www.lutze.com • info@lutze.com

United Kingdom: LÜTZE Ltd.

Unit 3, Sandy Hill Park

Sandy Way, Amington • GB-Tamworth, Staffs B77 4DU

Tel. +44 (0)1827 31333-0 • Fax +44 (0)1827 31333-2

www.lutze.com • sales.gb@lutze.co.uk



SYSTEMATIC TECHNOLOGY