

Technical data sheet · Plastic NPT



Identification	Type	NPT 1/2"
	Part-No.	600696S

Use/Area of application	
Properties	<ul style="list-style-type: none">• Integrated strain relief• Wide sealing and clamping range• Easy to install

Technical data	
Temperature range	-20 °C to +100 °C +14 to +212 F
Protection class	IP68 – 5 bar
Gasket	Polychloroprene-Nitrile rubber CR/NBR
Connecting thread	Connecting thread NPT

Design	
H	47.5 mm
L	15.0 mm
SW 1 = across flats	27 mm
SW 2 = across flats	27 mm
Internal thread	NPT

General	
Comments	For secure tightening of cable glands and accessories

08.12.2012 – Subject to technical modification

Part-No. 600696S

USA: LUTZE INC.

13330 South Ridge Drive • Charlotte, NC 28273, USA
Tel. +1 (704) 504-0222 • Fax +1 (704) 504-0223
www.lutze.com • info@lutze.com

United Kingdom: LÜTZE Ltd.

Unit 3, Sandy Hill Park
Sandy Way, Amington • GB-Tamworth, Staffs B77 4DU
Tel. +44 (0)1827 31333-0 • Fax +44 (0)1827 31333-2
www.lutze.com • sales.gb@lutze.co.uk

Technical data sheet · Plastic NPT

Dimensions

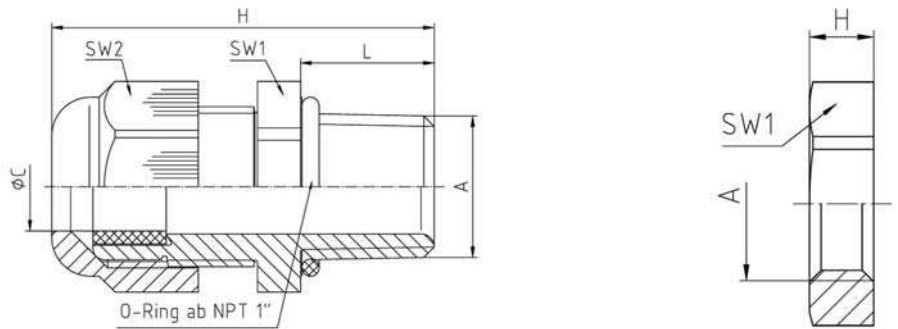

08.12.2012 – Subject to technical modification

Part-No. 600696S

USA: LUTZE INC.

13330 South Ridge Drive • Charlotte, NC 28273, USA
Tel. +1 (704) 504-0222 • Fax +1 (704) 504-0223
www.lutze.com • info@lutze.com

United Kingdom: LÜTZE Ltd.

Unit 3, Sandy Hill Park
Sandy Way, Amington • GB-Tamworth, Staffs B77 4DU
Tel. +44 (0)1827 31333-0 • Fax +44 (0)1827 31333-2
www.lutze.com • sales.gb@lutze.co.uk