



Identification	Type	LRC-UC-0190 3AC 575V 4kW
	Part-No.	700190

Technical data

Function type	Motor suppression
Protection device	RC module
Nominal voltage	3 ACx575 V
Rated frequency	50–60 Hz
Motor performance	4 kW
Type of connecting lead	H05V-K 1.0 mm ²
Length of connecting lead (M)	0.2 M

General

Form	UC
Housing material	PC
Protection class	IP 20
Field installation	rail TS 35 (EN 50022)
Termination	3 wires with fork-type cable lug M4
Operation temperature range	-20 °C – 60 °C
Storage temperature range	-40 °C ... 90 °C
Dimensions (w × h × d)	40.0 × 36.5 × 90.0 mm
Weight (kg/piece)	0.086

28.01.2017 – Subject to technical modification

Part-No. 700190

USA: LUTZE INC.

13330 South Ridge Drive • Charlotte, NC 28273, USA
Tel. +1 (704) 504-0222 • Fax +1 (704) 504-0223
www.lutze.com • info@lutze.com

United Kingdom: LÜTZE Ltd.

Unit 3, Sandy Hill Park
Sandy Way, Amington • GB-Tamworth, Staffs B77 4DU
Tel. +44 (0)1827 31333-0 • Fax +44 (0)1827 31333-2
www.lutze.com • sales.gb@lutze.co.uk



SYSTEMATIC TECHNOLOGY

Dimensions

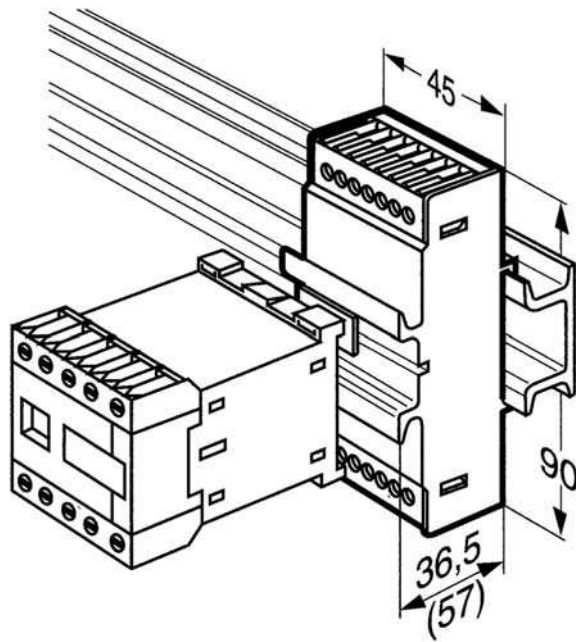

PIN assignment

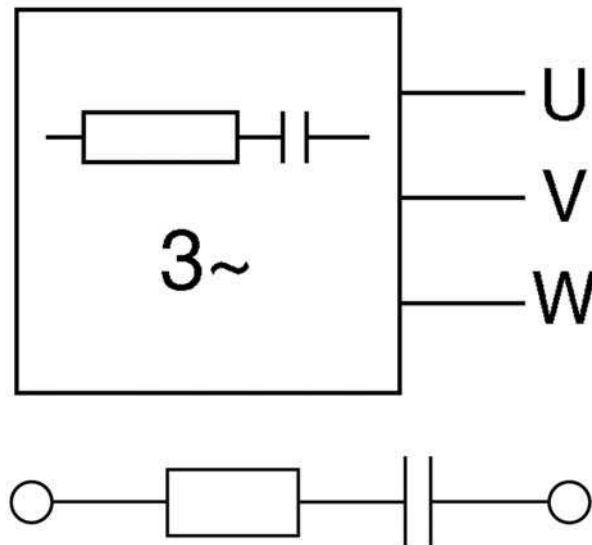

28.01.2017 – Subject to technical modification

Part-No. 700190

USA: LUTZE INC.

13330 South Ridge Drive • Charlotte, NC 28273, USA

Tel. +1 (704) 504-0222 • Fax +1 (704) 504-0223

www.lutze.com • info@lutze.com

United Kingdom: LÜTZE Ltd.

Unit 3, Sandy Hill Park

Sandy Way, Amington • GB-Tamworth, Staffs B77 4DU

Tel. +44 (0)1827 31333-0 • Fax +44 (0)1827 31333-2

www.lutze.com • sales.gb@lutze.co.uk