

<b>Identification</b>	Type	LD-V1-0475 DC 24-230V 1A
	Part-No.	700475

<b>Technical data</b>	
Function type	Suppressor for Switch Gear
Protection device	Diode
Nominal voltage	DC 24–230 V
Shut-off points	≤1 V
Inverse voltage/switching current	1600 V / 1 A
Type of connecting lead	LIY 0.5 mm <sup>2</sup>
Length of connecting lead (M)	0.2 M

<b>General</b>	
Form	V1
Pottant	2-components
Housing material	PPO
Protection class	IP 67
Field installation	With mounting hole M4, attachable to TS 35 (EN 50022) with 1 snap-on sockets
Termination	Fork-type cable lug M4
Operation temperature range	-20 °C – 60 °C
Storage temperature range	-40 °C ... 90 °C
Dimensions (w × h × d)	12.5 × 25.0 × 48.0 mm
Weight (kg/piece)	0.017

29.01.2017 – Subject to technical modification

Part-No. 700475

USA: LUTZE INC.

13330 South Ridge Drive • Charlotte, NC 28273, USA  
 Tel. +1 (704) 504-0222 • Fax +1 (704) 504-0223  
 www.lutze.com • info@lutze.com

United Kingdom: LÜTZE Ltd.

Unit 3, Sandy Hill Park  
 Sandy Way, Amington • GB-Tamworth, Staffs B77 4DU  
 Tel. +44 (0)1827 31333-0 • Fax +44 (0)1827 31333-2  
 www.lutze.com • sales.gb@lutze.co.uk



SYSTEMATIC TECHNOLOGY

# Technical data sheet · Suppression Technology

Approvals

cURus

## Dimensions

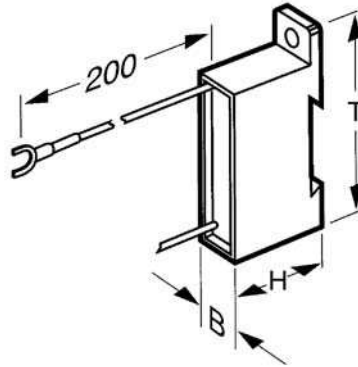

## PIN assignment



## Symbols



## Accessories

Accessories	Color	Article number	Description
Snap-on socket type 2	700499	for hat profile TS35 (EN 50022)	10

29.01.2017 – Subject to technical modification

Part-No. 700475

USA: LUTZE INC.

13330 South Ridge Drive · Charlotte, NC 28273, USA  
Tel. +1 (704) 504-0222 · Fax +1 (704) 504-0223  
www.lutze.com · info@lutze.com

United Kingdom: LÜTZE Ltd.

Unit 3, Sandy Hill Park  
Sandy Way, Amington · GB-Tamworth, Staffs B77 4DU  
Tel. +44 (0)1827 31333-0 · Fax +44 (0)1827 31333-2  
www.lutze.com · sales.gb@lutze.co.uk