



Identification	Type	LS-A-9461 7,5mPUR AC/DC 24V
	Part-No.	709461
Technical data		
Function type	Suppressors for valves	
Protection device	Suppressor diode + LED	
Nominal voltage	AC/DC 24 V	
Current Consumption per LED	4 mA	
Shut-off points	≤52 V	
Rated frequency	50–60 Hz	
Holding capacitance	<100 VA	
Type of connecting lead	PUR black jacket, PP wire 2 × 0.75 mm ²	
Length of connecting lead (M)	7.5 M	
Connecting lead	Ø 5.0 mm	
General		
Form	Construction A, contact clearance 18 mm	
Status indication LED	LED yellow	
Coil Current max.	≤4 A	
Conductor marking	black, blue	
Housing material	TPU transparent ¹⁾	
Protection class	IP 67	
Field installation	Breakaway torque 0.4 Nm Direct assembly with protective conduit is possible.	

29.01.2017 – Subject to technical modification

Part-No. 709461

USA: LUTZE INC.

13330 South Ridge Drive • Charlotte, NC 28273, USA
Tel. +1 (704) 504-0222 • Fax +1 (704) 504-0223
www.lutze.com • info@lutze.com

United Kingdom: LÜTZE Ltd.

Unit 3, Sandy Hill Park
Sandy Way, Amington • GB-Tamworth, Staffs B77 4DU
Tel. +44 (0)1827 31333-0 • Fax +44 (0)1827 31333-2
www.lutze.com • sales.gb@lutze.co.uk



SYSTEMATIC TECHNOLOGY

Technical data sheet • Suppression Technology

Operation temperature range	Male: -25 °C – 90 °C, cable: fixed -30 °C– 90 °C, moving -15 °C – 80 °C
Storage temperature range	-40 °C ... 90 °C
Dimensions (w × h × d)	28.0 × 26.5 × 48.0 mm
Weight (kg/piece)	0.360
Standards	EN 175301-803 (DIN 43 650), ISO 4400

Dimensions

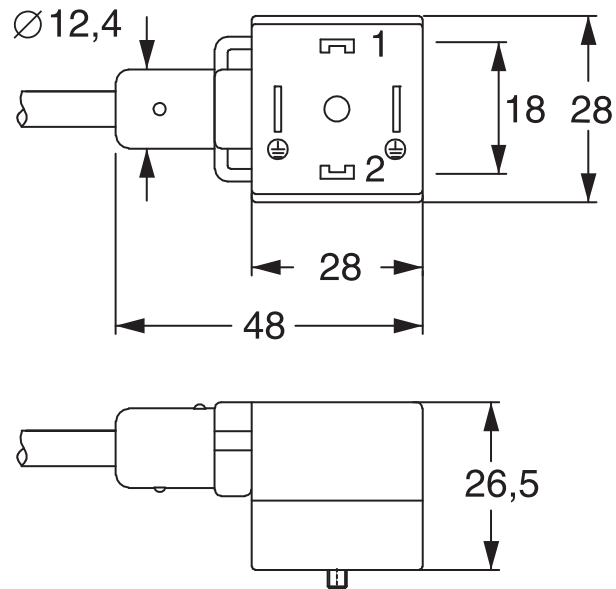

PIN assignment

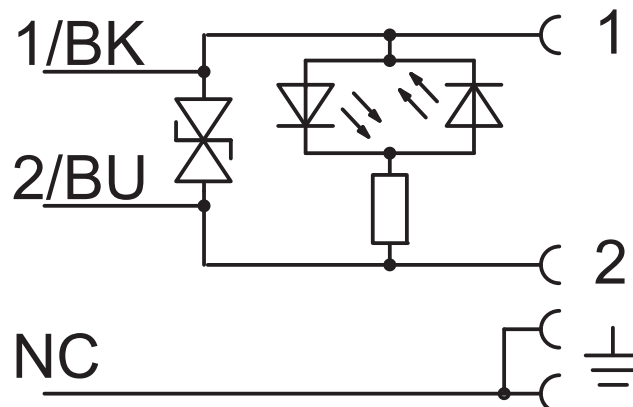

Accessories

29.01.2017 – Subject to technical modification

Part-No. 709461

USA: LUTZE INC.

13330 South Ridge Drive • Charlotte, NC 28273, USA

Tel. +1 (704) 504-0222 • Fax +1 (704) 504-0223

www.lutze.com • info@lutze.com

United Kingdom: LÜTZE Ltd.

Unit 3, Sandy Hill Park

Sandy Way, Amington • GB-Tamworth, Staffs B77 4DU

Tel. +44 (0)1827 31333-0 • Fax +44 (0)1827 31333-2

www.lutze.com • sales.gb@lutze.co.uk



SYSTEMATIC TECHNOLOGY

Technical data sheet - Suppression Technology

Accessories	Color	Article number	Type	PU
Tag holder 7×20 mm	white	760968	BZT-0720	100
Protective pipes:				
-PA	black	271142	CX 12 PA	50
-PVC with hard PVC coil	grey	270401	CF 12 EL	30
-PVC with steel braiding		270011	CF 13 S	50
-PUR with coil		270411	CF PUR 12 EL	22
Marker sleeve	transparent	499995		500
Plate 4×23mm for 499995		499988		200

Comments

¹⁾ Very good chemical and oil resistance. The material resistance must be checked based on the application for use with aggressive media!

29.01.2017 – Subject to technical modification

Part-No. 709461

USA: LUTZE INC.

13330 South Ridge Drive • Charlotte, NC 28273, USA
Tel. +1 (704) 504-0222 • Fax +1 (704) 504-0223
www.lutze.com • info@lutze.com

United Kingdom: LÜTZE Ltd.

Unit 3, Sandy Hill Park
Sandy Way, Amington • GB-Tamworth, Staffs B77 4DU
Tel. +44 (0)1827 31333-0 • Fax +44 (0)1827 31333-2
www.lutze.com • sales.gb@lutze.co.uk



SYSTEMATIC TECHNOLOGY