



Identification	Type	LS-AMP 9473 5m PUR
	Part-No.	709473
Technical data		
Function type	Suppressors for valves	
Protection device	Suppressor diode + LED	
Nominal voltage	AC/DC 24 V	
Current Consumption per LED	10 mA	
Shut-off points	≥75 V	
Rated frequency	50–60 Hz	
Holding capacitance	≤100 VA	
Type of connecting lead	PUR black/PE 2 × 0.75 mm ² ¹⁾	
Length of connecting lead (M)	5 M	
Connecting lead	∅ 5.2 ± 0.20 mm	
General		
Form	AMP Junior Timer, 2-pin	
Status indication LED	LED yellow	
Coil Current max.	≤4 A	
Conductor marking	black, blue	
Housing material	Polyamid 6.6	
Protection class	IP 65	
Field installation	plug-in	

29.01.2017 – Subject to technical modification

Part-No. 709473

USA: LUTZE INC.

13330 South Ridge Drive • Charlotte, NC 28273, USA
Tel. +1 (704) 504-0222 • Fax +1 (704) 504-0223
www.lutze.com • info@lutze.com

United Kingdom: LÜTZE Ltd.

Unit 3, Sandy Hill Park
Sandy Way, Amington • GB-Tamworth, Staffs B77 4DU
Tel. +44 (0)1827 31333-0 • Fax +44 (0)1827 31333-2
www.lutze.com • sales.gb@lutze.co.uk



SYSTEMATIC TECHNOLOGY

Technical data sheet • Suppression Technology

Operation temperature range	Male: -25 °C – 80 °C, cable: fixed -30 °C– 90 °C, moving -15 °C – 80 °C
Storage temperature range	-40 °C ... 90 °C
Dimensions (w × h × d)	24.3 × 40.0 × 52.0 mm
Weight (kg/piece)	0.235

Dimensions

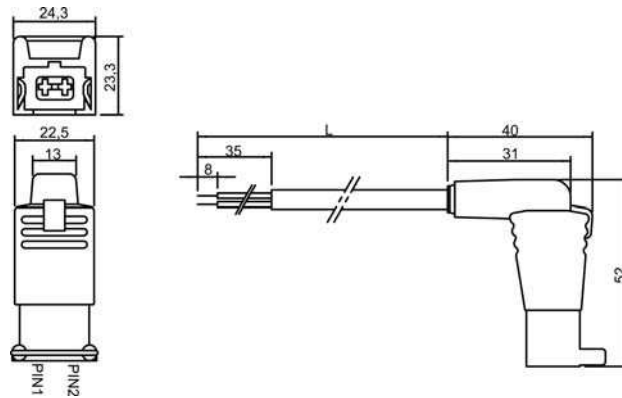

PIN assignment

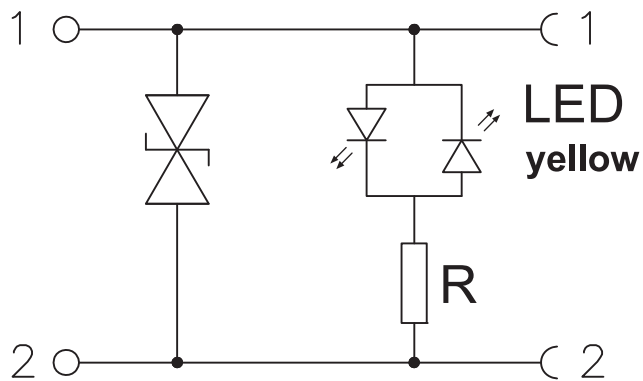

Comments

¹⁾ Excellent chemical and oil resistance. The material resistance must be checked based on the application for use with aggressive media!

29.01.2017 – Subject to technical modification

Part-No. 709473

USA: LUTZE INC.

13330 South Ridge Drive • Charlotte, NC 28273, USA
Tel. +1 (704) 504-0222 • Fax +1 (704) 504-0223
www.lutze.com • info@lutze.com

United Kingdom: LÜTZE Ltd.

Unit 3, Sandy Hill Park
Sandy Way, Amington • GB-Tamworth, Staffs B77 4DU
Tel. +44 (0)1827 31333-0 • Fax +44 (0)1827 31333-2
www.lutze.com • sales.gb@lutze.co.uk



SYSTEMATIC TECHNOLOGY