



Identification	Type	LDS-A-9771 10mPUR DC 24V
	Part-No.	709771

Technical data	
Function type	Pressure switch / fill level monitor
Nominal voltage	DC 24 V
Nominal voltage range	V – 30 V
Current Consumption per LED	4 mA
Type of connecting lead	PUR black/PVC 3 × 0.5 mm ²
Length of connecting lead (M)	10 M
Connecting lead	∅ 5.6 + 0.15 mm

General	
Form	Construction A, contact clearance 18 mm
Status indication LED	LED yellow + LED green
Conductor marking	color-coded conductors
Housing material	TPU transparent ¹⁾
Protection class	IP 67
Field installation	Breakaway torque 0.4 Nm Direct assembly with protective conduit is possible.
Operation temperature range	Male: -25 °C – 90 °C, cable: fixed -40 °C– 80 °C, moving -20 °C – 80 °C
Storage temperature range	-40 °C ... 90 °C
Dimensions (w × h × d)	28.0 × 26.5 × 48.0 mm
Weight (kg/piece)	0.530

29.01.2017 – Subject to technical modification

Part-No. 709771

USA: LUTZE INC.

13330 South Ridge Drive • Charlotte, NC 28273, USA
Tel. +1 (704) 504-0222 • Fax +1 (704) 504-0223
www.lutze.com • info@lutze.com

United Kingdom: LÜTZE Ltd.

Unit 3, Sandy Hill Park
Sandy Way, Amington • GB-Tamworth, Staffs B77 4DU
Tel. +44 (0)1827 31333-0 • Fax +44 (0)1827 31333-2
www.lutze.com • sales.gb@lutze.co.uk



SYSTEMATIC TECHNOLOGY

Technical data sheet • Suppression Technology

Standards

EN 175301-803 (DIN 43 650), ISO 4400

Dimensions

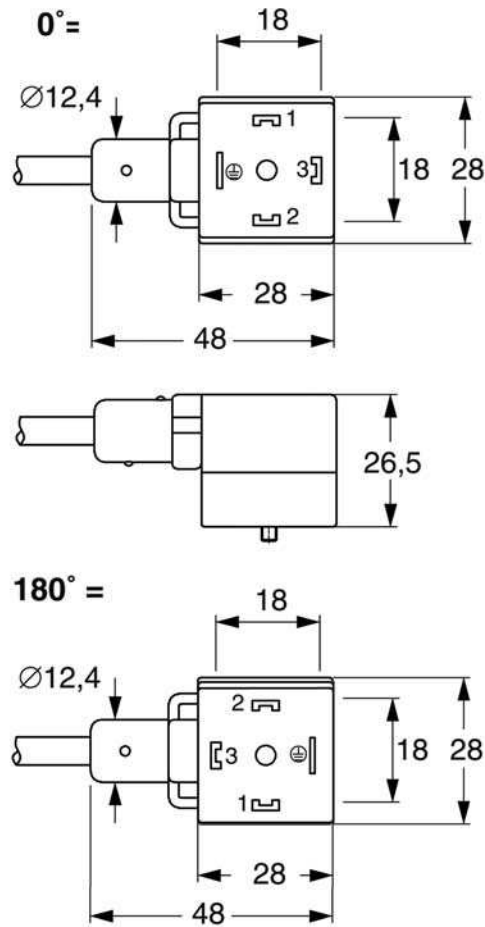

PIN assignment

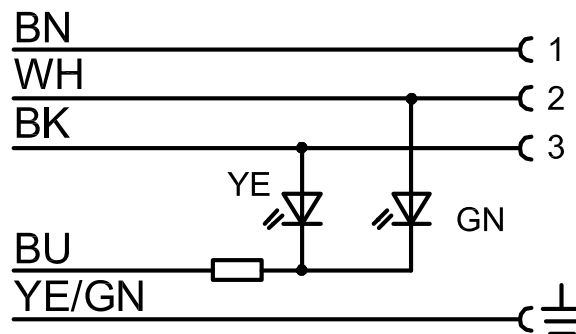

Accessories

29.01.2017 – Subject to technical modification

Part-No. 709771

USA: LUTZE INC.

13330 South Ridge Drive • Charlotte, NC 28273, USA
 Tel. +1 (704) 504-0222 • Fax +1 (704) 504-0223
 www.lutze.com • info@lutze.com

United Kingdom: LÜTZE Ltd.

Unit 3, Sandy Hill Park
 Sandy Way, Amington • GB-Tamworth, Staffs B77 4DU
 Tel. +44 (0)1827 31333-0 • Fax +44 (0)1827 31333-2
 www.lutze.com • sales.gb@lutze.co.uk



SYSTEMATIC TECHNOLOGY

Technical data sheet - Suppression Technology

Accessories	Color	Article number	Type	PU
Tag holder 7×20 mm	white	760968	BZT-0720	100
Protective pipes:				
-PA	black	271142	CX 12 PA	50
-PVC with hard PVC coil	grey	270401	CF 12 EL	30
-PVC with steel braid		270011	CF 13 S	50
-PUR with Conduflex coil		270411	CF PUR 12 EL	22
Designation sleeve	transparent	499995		500
Tag holder 4×23 mm for 499995		499988		200

Comments

¹⁾ Excellent chemical and oil resistance. The material resistance must be checked based on the application for use with aggressive media!

29.01.2017 – Subject to technical modification

Part-No. 709771

USA: LUTZE INC.

13330 South Ridge Drive • Charlotte, NC 28273, USA
Tel. +1 (704) 504-0222 • Fax +1 (704) 504-0223
www.lutze.com • info@lutze.com

United Kingdom: LÜTZE Ltd.

Unit 3, Sandy Hill Park
Sandy Way, Amington • GB-Tamworth, Staffs B77 4DU
Tel. +44 (0)1827 31333-0 • Fax +44 (0)1827 31333-2
www.lutze.com • sales.gb@lutze.co.uk



SYSTEMATIC TECHNOLOGY