



Identification	Type	UBE-D-1844
	Part-No.	711844
Technical data		
Function type	Interface Module	
Number of terminations	9	
Plug	Sub-D pin strip according to DIN 41652	
Nominal voltage	AC/DC 125 V	
Rated current	1 A	
Rated insulation voltage (EN 40178)	150 V	
Pollution degree	2	
Overvoltage category	I	
General		
Housing material	PPE	
Protection class	IP 00	
Field installation	rail TS 35 (EN 50022)	
Operation temperature range	-25 °C – 60 °C	
Storage temperature range	-40 °C – 80 °C	
Dimensions (w × h × d)	35.0×78.0×58.0 mm	
Weight (kg/piece)	0.058	
Termination	Screw terminal 0.5–2.5 mm ²	

20.04.2013 – Subject to technical modification

Part-No. 711844

USA: LUTZE INC.

13330 South Ridge Drive • Charlotte, NC 28273, USA
 Tel. +1 (704) 504-0222 • Fax +1 (704) 504-0223
 www.lutze.com • info@lutze.com

United Kingdom: LÜTZE Ltd.

Unit 3, Sandy Hill Park
 Sandy Way, Amington • GB-Tamworth, Staffs B77 4DU
 Tel. +44 (0)1827 31333-0 • Fax +44 (0)1827 31333-2
 www.lutze.com • sales.gb@lutze.co.uk



Technical data sheet · Function module

Dimensions

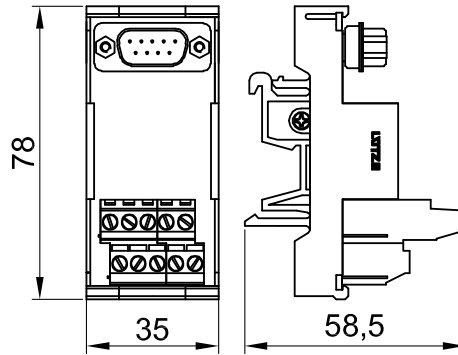

PIN assignment

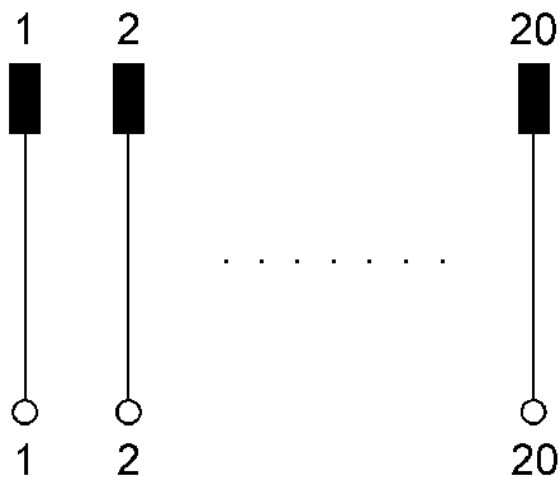

Accessories

Accessories	Colour	Article number	Type	PU
Mating connector (female) 9-pole		710847	KBG-D/9F	10
Mating connector (female) 15-pole		710855	KBG-D/15F	10
Mating connector (female) 25-pole		710861	KBG-D/25F	10
Mating connector (female) 37-pole		710873	KBG-D/37F	10

Comments

Designs with soldering terminals are available on request!

20.04.2013 – Subject to technical modification

Part-No. 711844

USA: LUTZE INC.

13330 South Ridge Drive · Charlotte, NC 28273, USA

Tel. +1 (704) 504-0222 · Fax +1 (704) 504-0223

www.lutze.com · info@lutze.com

United Kingdom: LÜTZE Ltd.

Unit 3, Sandy Hill Park

Sandy Way, Amington · GB-Tamworth, Staffs B77 4DU

Tel. +44 (0)1827 31333-0 · Fax +44 (0)1827 31333-2

www.lutze.com · sales.gb@lutze.co.uk



SYSTEMATIC TECHNOLOGY