



Identification	Type	UBE-D-1860
	Part-No.	711860

Technical data

Function type	Interface Module
Number of terminations	25
Plug	Sub-D female according to DIN 41652
Nominal voltage	AC/DC 125 V
Rated current	1 A
Rated insulation voltage (EN 40178)	150 V
Pollution degree	2
Overvoltage category	I

General

Housing material	PPE
Protection class	IP 00
Field installation	rail TS 35 (EN 50022)
Operation temperature range	-25 °C – 60 °C
Storage temperature range	-40 °C – 80 °C
Dimensions (w × h × d)	70.0×78.0×58.0 mm
Weight (kg/piece)	0.118
Termination	Screw terminal 0.5–2.5 mm ²

20.04.2013 – Subject to technical modification

Part-No. 711860

USA: LUTZE INC.

13330 South Ridge Drive • Charlotte, NC 28273, USA
 Tel. +1 (704) 504-0222 • Fax +1 (704) 504-0223
 www.lutze.com • info@lutze.com

United Kingdom: LÜTZE Ltd.

Unit 3, Sandy Hill Park
 Sandy Way, Amington • GB-Tamworth, Staffs B77 4DU
 Tel. +44 (0)1827 31333-0 • Fax +44 (0)1827 31333-2
 www.lutze.com • sales.gb@lutze.co.uk



Technical data sheet · Function module

Dimensions

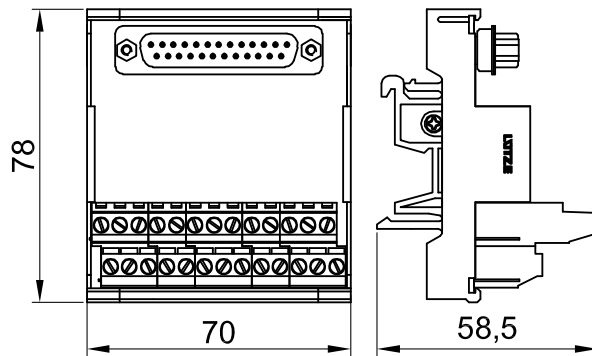

PIN assignment

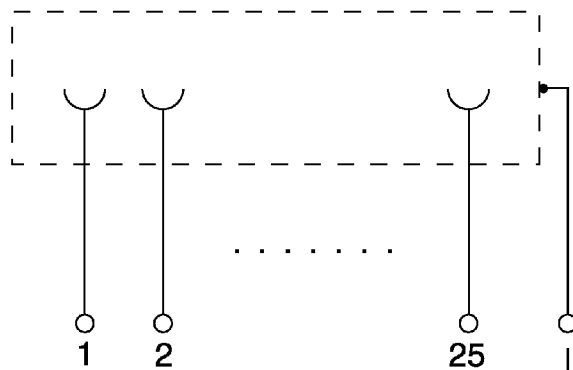

Accessories

Accessories	Colour	Article number	Type	PU
Mating plug (pin) 9-pole		710845	KBG-D/9M	10
Mating plug (pin) 15-pole		710853	KBG-D/15M	10
Mating plug (pin) 25-pole		710859	KBG-D/25M	10
Mating plug (pin) 37-pole		710871	KBG-D/37M	10

Comments

Designs with soldering terminals are available on request!

20.04.2013 – Subject to technical modification

Part-No. 711860

USA: LUTZE INC.

13330 South Ridge Drive · Charlotte, NC 28273, USA

Tel. +1 (704) 504-0222 · Fax +1 (704) 504-0223

www.lutze.com · info@lutze.com

United Kingdom: LÜTZE Ltd.

Unit 3, Sandy Hill Park

Sandy Way, Amington · GB-Tamworth, Staffs B77 4DU

Tel. +44 (0)1827 31333-0 · Fax +44 (0)1827 31333-2

www.lutze.com · sales.gb@lutze.co.uk



SYSTEMATIC TECHNOLOGY