



Identification	Type	UBE-FL-1862
	Part-No.	711862

Technical data	
Function type	Interface Module
Number of terminations	26
Plug	Sub-D pin strip according to DIN 41652
Nominal voltage	AC/DC 125 V
Rated current	1 A
Rated insulation voltage (EN 40178)	150 V
Pollution degree	2
Overvoltage category	I

General	
Housing material	PPE
Protection class	IP 00
Field installation	rail TS 35 (EN 50022)
Operation temperature range	-25 °C – 60 °C
Storage temperature range	-40 °C – 80 °C
Dimensions (w × h × d)	70.0×78.0×58.0 mm
Weight (kg/piece)	0.110
Termination	Screw terminal 0.5–2.5 mm ²

20.04.2013 – Subject to technical modification

Part-No. 711862

USA: LUTZE INC.

13330 South Ridge Drive • Charlotte, NC 28273, USA
 Tel. +1 (704) 504-0222 • Fax +1 (704) 504-0223
 www.lutze.com • info@lutze.com

United Kingdom: LÜTZE Ltd.

Unit 3, Sandy Hill Park
 Sandy Way, Amington • GB-Tamworth, Staffs B77 4DU
 Tel. +44 (0)1827 31333-0 • Fax +44 (0)1827 31333-2
 www.lutze.com • sales.gb@lutze.co.uk



Technical data sheet • Function module

Dimensions

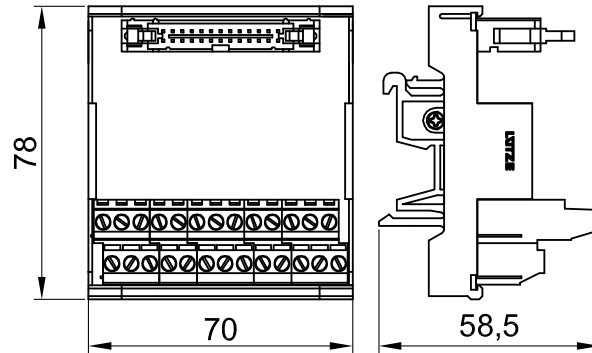

PIN assignment

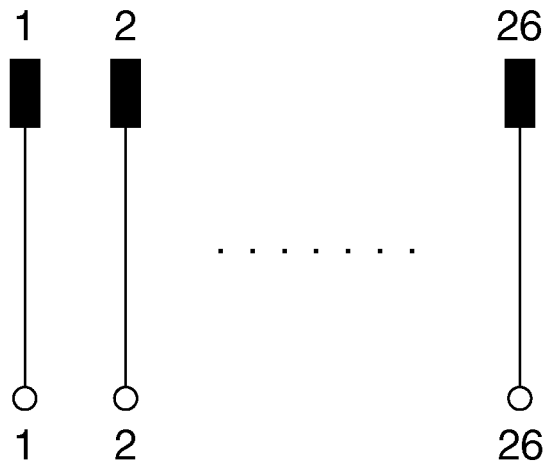

Accessories

Accessories	Colour	Article number	Type	PU
Mating plug 10-pole		710849	KBG-FL/10F	10
Mating plug 14-pole		710851	KBG-FL/14F	10
Mating plug 16-pole		710857	KBG-FL/16F	10
Mating plug 20-pole		710858	KBG-FL/20F	10
Mating plug 26-pole		710863	KBG-FL/26F	10
Mating plug 34-pole		710869	KBG-FL/34F	10
Mating plug 40-pole		710874	KBG-FL/40F	10
Mating plug 60-pole		710884	KBG-FL/60F	10
Mating plug 64-pole		710886	KBG-FL/64F	10

Comments

Designs with soldering terminals are available on request!

20.04.2013 – Subject to technical modification

Part-No. 711862

USA: LUTZE INC.

13330 South Ridge Drive • Charlotte, NC 28273, USA

Tel. +1 (704) 504-0222 • Fax +1 (704) 504-0223

www.lutze.com • info@lutze.com

United Kingdom: LÜTZE Ltd.

Unit 3, Sandy Hill Park

Sandy Way, Amington • GB-Tamworth, Staffs B77 4DU

Tel. +44 (0)1827 31333-0 • Fax +44 (0)1827 31333-2

www.lutze.com • sales.gb@lutze.co.uk



SYSTEMATIC TECHNOLOGY