

Relay



Identification

Type
Part-No.

RE3W-0300 DC12
770300

Input

Nominal voltage DC 12 V
Power consumption AC: 1.2VA, DC: 0.9W
Interrupting voltage AC: $\geq 0.2 U_n$, DC: $> 0.1 U_n$

Output

Min. switching voltage AC/DC 5 V
Max. switching voltage AC/DC 250 V
Min. switching current AgNi: AC/DC 5mA; AgNi+ 5 μ m HV: AC/DC 2mA
Max. switching current AC1: 7A / 250VAC, DC1: 7A / 24VDC
Switching capacity AC 15 3.3A
Switching capacity DC 13 24V: 2A, 115V: 300mA, 230V: 150mA
Max. switching capacity 1750 VA
Switching frequency AC1: 1,200 cycles/hour, without load 18,000 cycles/hour
Mechanical service life $> 2 \times 10^7$ operations
Switch-on delay 25 ms
Switch-off delay 25 ms
Clearance/creep. dist. (control/load side) Clearance distance: > 2.5 mm; creepage distance: > 4 mm
Overvoltage category III
Pollution degree 3

20.04.2013 – Subject to technical modification

Part-No. 770300

USA: LUTZE INC.
13330 South Ridge Drive • Charlotte, NC 28273, USA
Tel. +1 (704) 504-0222 • Fax +1 (704) 504-0223
www.lutze.com • info@lutze.com

United Kingdom: LÜTZE Ltd.
Unit 3, Sandy Hill Park
Sandy Way, Amington • GB-Tamworth, Staffs B77 4DU
Tel. +44 (0)1827 31333-0 • Fax +44 (0)1827 31333-2
www.lutze.com • sales.gb@lutze.co.uk



SYSTEMATIC TECHNOLOGY

Technical data sheet - Accessories

General

Contact type	3 change over contact
Rated insulation voltage (EN 50178)	AC 250V (C 250)
Resistor	< 100 mΩ
Contact material	AgNi / AgNi+5μm HV
Protection class	IP 40
Protection class	RT1 - dust proof
Shock resistance	10 g
Vibration resistance	5g, 10...55Hz
Operation temperature range	-40 °C – 70 °C
Storage temperature range	-40 °C – 85 °C
Dimensions (w × h × d)	28.0×21.2×35.0 mm
Weight (kg/piece)	0.037
Approvals	cULus, TÜV, CQC
Termination	plug-in

Dimensions

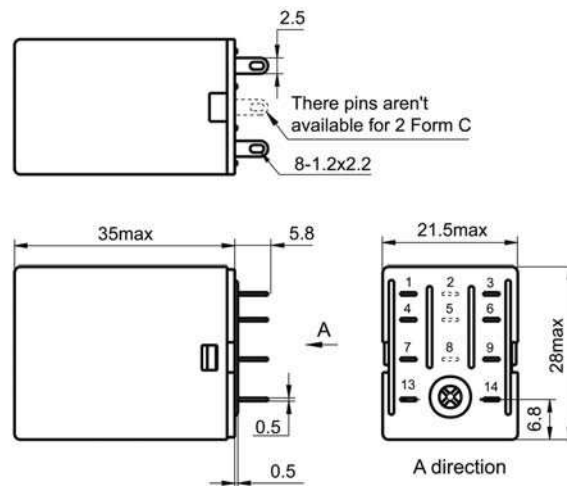

20.04.2013 – Subject to technical modification

Part-No. 770300

USA: LUTZE INC.

13330 South Ridge Drive • Charlotte, NC 28273, USA
Tel. +1 (704) 504-0222 • Fax +1 (704) 504-0223
www.lutze.com • info@lutze.com

United Kingdom: LÜTZE Ltd.

Unit 3, Sandy Hill Park
Sandy Way, Amington • GB-Tamworth, Staffs B77 4DU
Tel. +44 (0)1827 31333-0 • Fax +44 (0)1827 31333-2
www.lutze.com • sales.gb@lutze.co.uk



SYSTEMATIC TECHNOLOGY

Limit curve

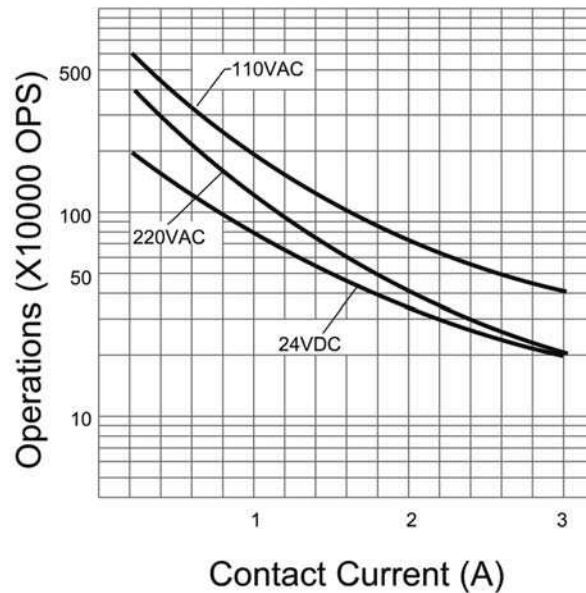
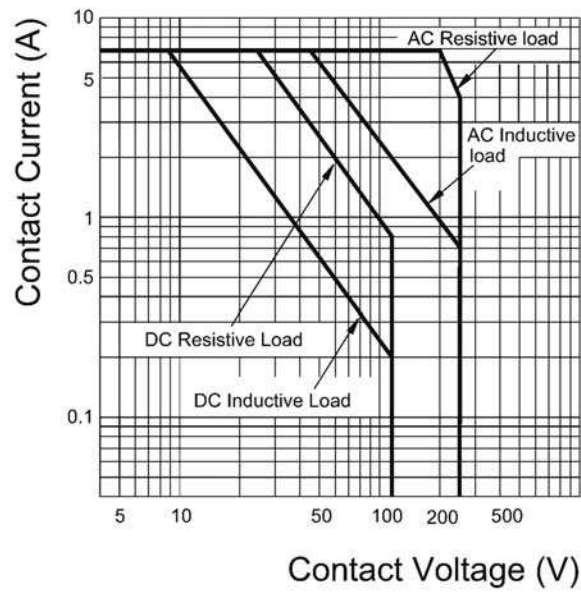

20.04.2013 – Subject to technical modification

Part-No. 770300

USA: LUTZE INC.

13330 South Ridge Drive • Charlotte, NC 28273, USA
 Tel. +1 (704) 504-0222 • Fax +1 (704) 504-0223
 www.lutze.com • info@lutze.com

United Kingdom: LÜTZE Ltd.

Unit 3, Sandy Hill Park
 Sandy Way, Amington • GB-Tamworth, Staffs B77 4DU
 Tel. +44 (0)1827 31333-0 • Fax +44 (0)1827 31333-2
 www.lutze.com • sales.gb@lutze.co.uk



SYSTEMATIC TECHNOLOGY