

Identification	Type	REI3-0340 3W DC 12 V
	Part-No.	770340

Input

Input voltage range	9.6 V – 13.2 V
Nominal voltage	DC 12 V
Rated current	75.0 mA
Interrupting voltage	<1.2 V
Protection device	Free-wheeling diode
Status Indication	LED green
Power consumption	0.9 W

Load Side

Contact type	3 change over contact
Min. switching voltage	AC/DC 5 V
Max. switching voltage	AC/DC 250 V
Min. switching current	AgNi: AC/DC 5mA; AgNi+5µm HV: AC/DC 2mA
Max. switching current	AC/DC 7 A
Switching capacity AC 15	at 24 V: 2.5 A; at 230 V: 1.5 A
Switching capacity DC 13	at 24 V: 1.8A; at 115 V: 300 mA, at 230 V: 150 mA
Max. switching capacity	1750 VA
Contact material	AgNi or AgNi + 5 µm HV
Mechanical service life	>2 x 10 ⁷ operations

20.04.2013 – Subject to technical modification

Part-No. 770340

USA: LUTZE INC.

13330 South Ridge Drive • Charlotte, NC 28273, USA
 Tel. +1 (704) 504-0222 • Fax +1 (704) 504-0223
 www.lutze.com • info@lutze.com

United Kingdom: LÜTZE Ltd.

Unit 3, Sandy Hill Park
 Sandy Way, Amington • GB-Tamworth, Staffs B77 4DU
 Tel. +44 (0)1827 31333-0 • Fax +44 (0)1827 31333-2
 www.lutze.com • sales.gb@lutze.co.uk



SYSTEMATIC TECHNOLOGY

Technical data sheet - Interface Technology

Switch-on delay	25 ms
Switch-off delay	25 ms
Clearance/creep. dist. (control/load side)	Clearance distance: > 2 mm; creepage distance: > 3mm

General

Housing material	PA 66+GF V0 (UL)
Protection class	IP 20
Field installation	rail TS 35 (EN 50022)
Insulation voltage input/output	1.5 kV _{eff}
Safe isolation	yes
Operation temperature range	-40 °C – 70 °C
Storage temperature range	-40 °C – 85 °C
Dimensions (w × h × d)	27.2×75.0×82.0 mm
Weight (kg/piece)	0.107
Approvals	UL, CSA
Termination	Screw terminal: 0.2–4.0 mm ²

Dimensions

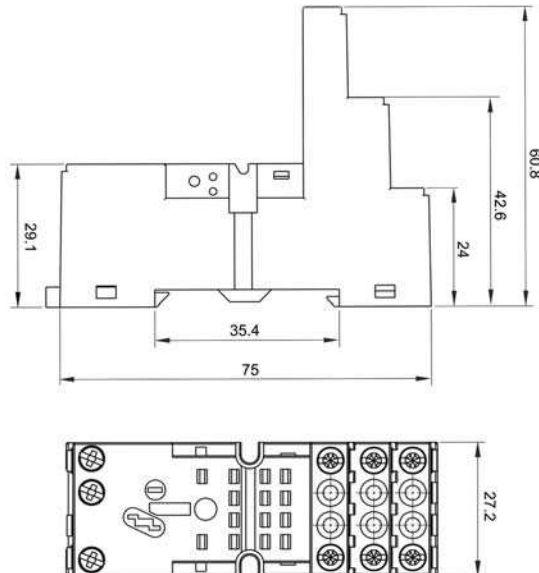

20.04.2013 – Subject to technical modification

Part-No. 770340

USA: LUTZE INC.

13330 South Ridge Drive • Charlotte, NC 28273, USA
Tel. +1 (704) 504-0222 • Fax +1 (704) 504-0223
www.lutze.com • info@lutze.com

United Kingdom: LÜTZE Ltd.

Unit 3, Sandy Hill Park
Sandy Way, Amington • GB-Tamworth, Staffs B77 4DU
Tel. +44 (0)1827 31333-0 • Fax +44 (0)1827 31333-2
www.lutze.com • sales.gb@lutze.co.uk



SYSTEMATIC TECHNOLOGY

PIN assignment

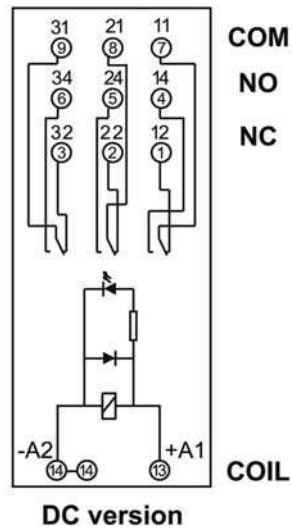

20.04.2013 – Subject to technical modification

Part-No. 770340

USA: LUTZE INC.

13330 South Ridge Drive · Charlotte, NC 28273, USA
Tel. +1 (704) 504-0222 · Fax +1 (704) 504-0223
www.lutze.com · info@lutze.com

United Kingdom: LÜTZE Ltd.

Unit 3, Sandy Hill Park
Sandy Way, Amington · GB-Tamworth, Staffs B77 4DU
Tel. +44 (0)1827 31333-0 · Fax +44 (0)1827 31333-2
www.lutze.com · sales.gb@lutze.co.uk

Limit curve

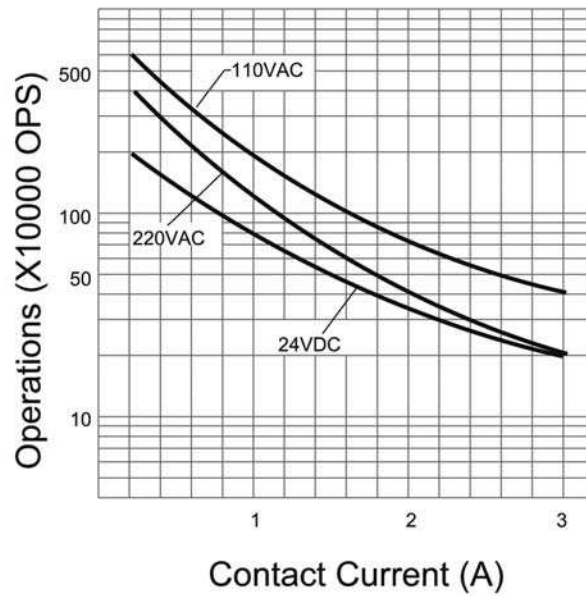
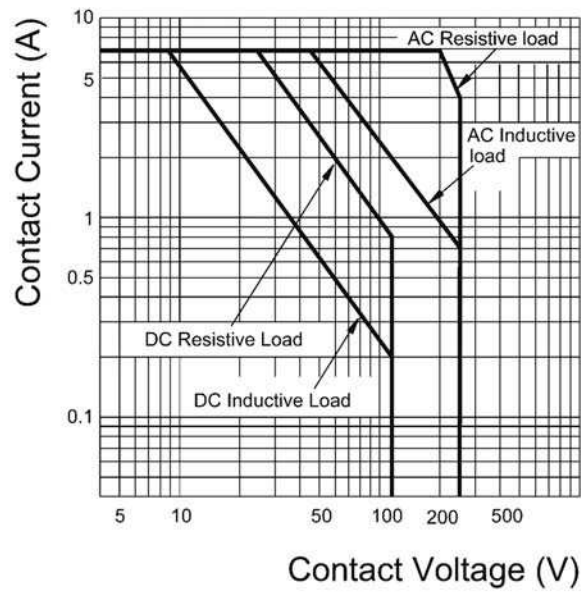

Accessories

20.04.2013 – Subject to technical modification

Part-No. 770340

USA: LUTZE INC.

13330 South Ridge Drive • Charlotte, NC 28273, USA

Tel. +1 (704) 504-0222 • Fax +1 (704) 504-0223

www.lutze.com • info@lutze.com

United Kingdom: LÜTZE Ltd.

Unit 3, Sandy Hill Park

Sandy Way, Amington • GB-Tamworth, Staffs B77 4DU

Tel. +44 (0)1827 31333-0 • Fax +44 (0)1827 31333-2

www.lutze.com • sales.gb@lutze.co.uk



SYSTEMATIC TECHNOLOGY

Technical data sheet - Interface Technology

Accessories	Colour	Article number	Type	PU
Relay socket		770904	RES3W-0904	10
Backup relay DC 12V		770300	RE3W-0300 DC12	10
Backup relay DC 12V HV		770320	RE3WHV-0320 DC12	10
Backup relay DC 24V		770301	RE3W-0301 DC24	10
Backup relay DC 24V HV		770321	RE3WHV-0321 DC24	10
Backup relay DC 110V		770306	RE3W-0306 DC120	10
Backup relay DC 110V HV		770326	RE3WHV-0326 DC120	10
Protecting module AC 6-24V		770911	PM41G-0911	10
Protecting module DC 110V		770916	PM43G-0916	10
Plate		770907	REM WT-0907	10
Jumper comb 10A	black	770909	REI-0909	10

Comments

Part-No.

Hard gold-plated contacts: So that the gold layer is not damaged, the specified values are not permitted to be exceeded. At higher switching capacity, the gold layer vaporizes. The deposition in the housing can lead to sparkovers between the coil and contact.

20.04.2013 – Subject to technical modification

Part-No. 770340

USA: LUTZE INC.

13330 South Ridge Drive • Charlotte, NC 28273, USA
Tel. +1 (704) 504-0222 • Fax +1 (704) 504-0223
www.lutze.com • info@lutze.com

United Kingdom: LÜTZE Ltd.

Unit 3, Sandy Hill Park
Sandy Way, Amington • GB-Tamworth, Staffs B77 4DU
Tel. +44 (0)1827 31333-0 • Fax +44 (0)1827 31333-2
www.lutze.com • sales.gb@lutze.co.uk



SYSTEMATIC TECHNOLOGY