

Montageanweisung
Installation Instructions
Notice d'installation
Istruzioni per il montaggio

Instrucciones de montaje
Инструкция по монтажу
安装说明

MOELLER



ALPHA

LOVAS

FI, FIP, HPFI, PFI FIS, FIPS, PFIS

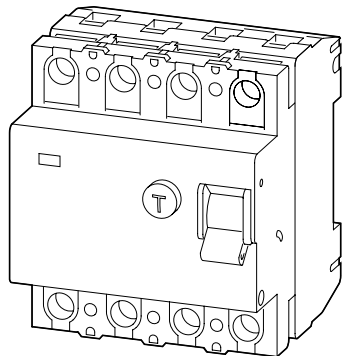

FI(S), FIP(S), HPFI, PFI(S)

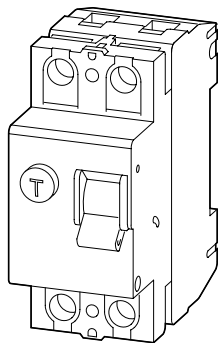

FI, FIP, HPFI, PFI

FI, FIP, HPFI, PFI FI(S), FIP(S), HPFI, PFI(S)

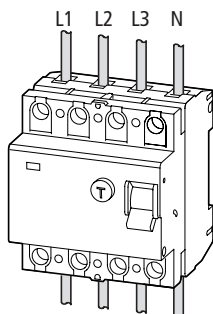
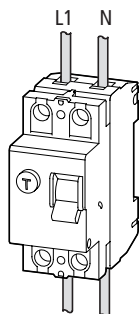

Lebensgefahr durch elektrischen Strom!

Nur Elektrofachkräfte und elektrotechnisch unterwiesene Personen dürfen die im Folgenden beschriebenen Arbeiten ausführen.

Electric current! Danger to life!

Only skilled or instructed persons may carry out the following operations.

Tension électrique dangereuse !

Seules les personnes qualifiées et averties doivent exécuter les travaux ci-après.

Tensione elettrica: Pericolo di morte!

Solo persone abilitate e qualificate possono eseguire le operazioni di seguito riportate.

¡Corriente eléctrica! ¡Peligro de muerte!

El trabajo a continuación descrito debe ser realizado por personas cualificadas y advertidas.

Электрический ток! Опасно для жизни!

Только специалисты или проинструктированные лица могут выполнять следующие операции.

触电危险!

只允许专业人员和受过专业训练的人员进行下列工作。



Z 2

FI(P)-2(4)-... HPFI, PFI	$\cong 40 \text{ A}$	2P	4P
	1 × (1.5 – 35)	3.0 Nm	2.4 Nm
mm ²	2 × 16		

FI(P)(S)-4-... HPFI, PFI, PFIS	$\cong 63 \text{ A}$	4P
	1 × (1.5 – 35)	3.0 Nm
mm ²	2 × 16	

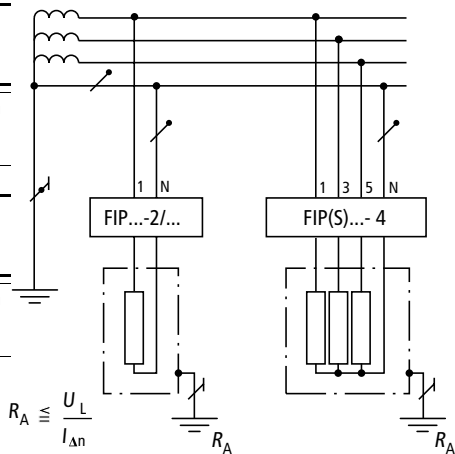

1 RESET

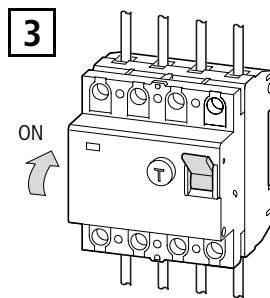
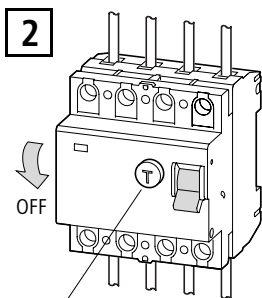

1 TEST

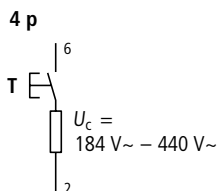
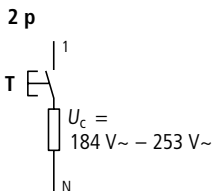
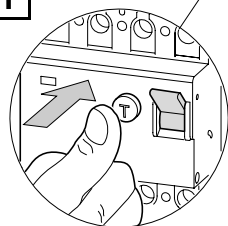

TEST
 einmal im Monat
 once a month
 une fois par mois
 una volta per mese
 una vez al mes
 один раз в месяц
 每月一次

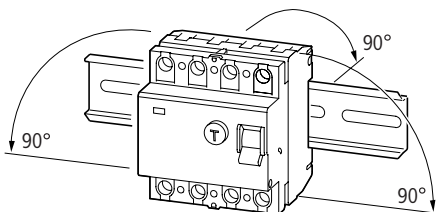

 FI(P)(S)-... HPFI, PFI, PFIS	2P, 4P	$\cong 63 \text{ A}$	gG/gL 63 A
FI(P)(S)-... HPFI, PFI, PFIS	2P, 4P	= 80 A	gG/gL 80 A