

Montageanweisung  
Installation Instructions  
Notice d'installation  
Istruzioni per il montaggio

Instrucciones de montaje  
Инструкция по монтажу  
安装说明

# MOELLER



ALPHA

LOVAS

## FI, FIP, HPFI, PFI FIS, FIPS, PFIS

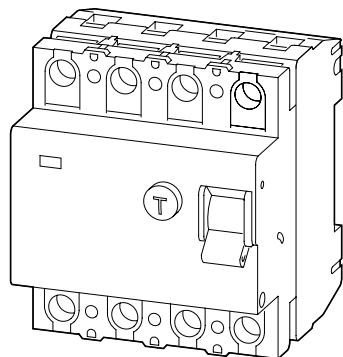

FI(S), FIP(S), HPFI, PFI(S)

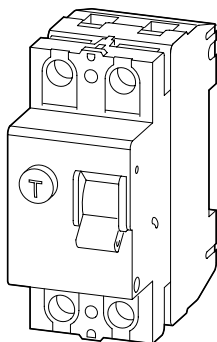

FI, FIP, HPFI, PFI

### FI, FIP, HPFI, PFI      FI(S), FIP(S), HPFI, PFI(S)

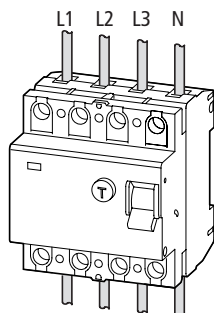
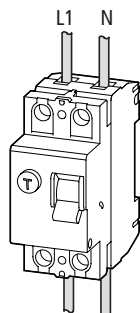

**Lebensgefahr durch elektrischen Strom!**

Nur Elektrofachkräfte und elektrotechnisch unterwiesene Personen dürfen die im Folgenden beschriebenen Arbeiten ausführen.

**Electric current! Danger to life!**

Only skilled or instructed persons may carry out the following operations.

**Tension électrique dangereuse !**

Seules les personnes qualifiées et averties doivent exécuter les travaux ci-après.

**Tensione elettrica: Pericolo di morte!**

Solo persone abilitate e qualificate possono eseguire le operazioni di seguito riportate.

**¡Corriente eléctrica! ¡Peligro de muerte!**

El trabajo a continuación descrito debe ser realizado por personas cualificadas y advertidas.

**Электрический ток! Опасно для жизни!**

Только специалисты или проинструктированные лица могут выполнять следующие операции.

触电危险!

只允许专业人员和受过专业训练的人员进行下列工作。



Z 2

<b>FI(P)-2(4)-...</b> <b>HPFI, PFI</b>	$\cong 40 \text{ A}$	<b>2P</b>	<b>4P</b>
 mm <sup>2</sup>	1 × (1.5 – 35) 2 × 16	3.0 Nm	2.4 Nm

<b>FI(P)(S)-4-...</b> <b>HPFI, PFI, PFIS</b>	$\cong 63 \text{ A}$	<b>4P</b>
 mm <sup>2</sup>	1 × (1.5 – 35) 2 × 16	3.0 Nm

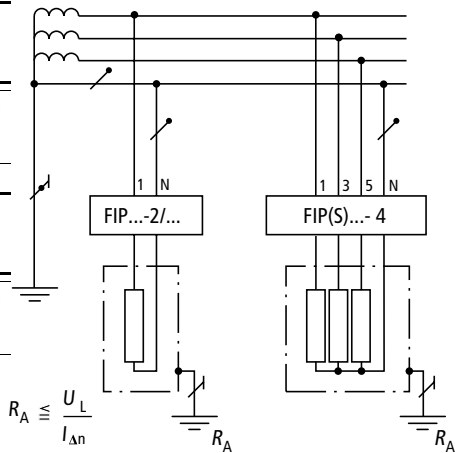

**1** RESET

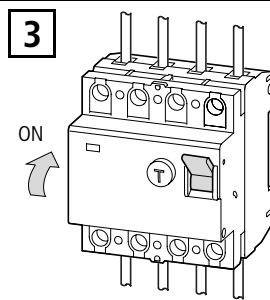
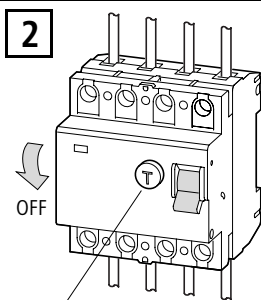

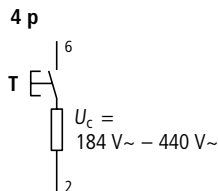
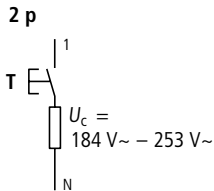
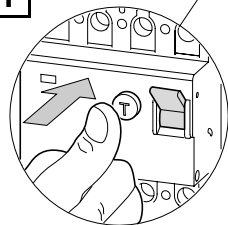

**1** TEST

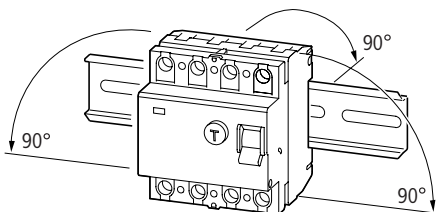

TEST  
 einmal im Monat  
 once a month  
 une fois par mois  
 una volta per mese  
 una vez al mes  
 один раз в месяц  
 每月一次



 <b>FI(P)(S)-...</b> HPFI, PFI, PFIS	<b>2P, 4P</b>	$\cong 63 \text{ A}$	gG/gL 63 A 
<b>FI(P)(S)-...</b> HPFI, PFI, PFIS	<b>2P, 4P</b>	$= 80 \text{ A}$	gG/gL 80 A 