

07/16 IL03801021Z
(AWA115-587, IL00802008E)

T0-..., T3-...

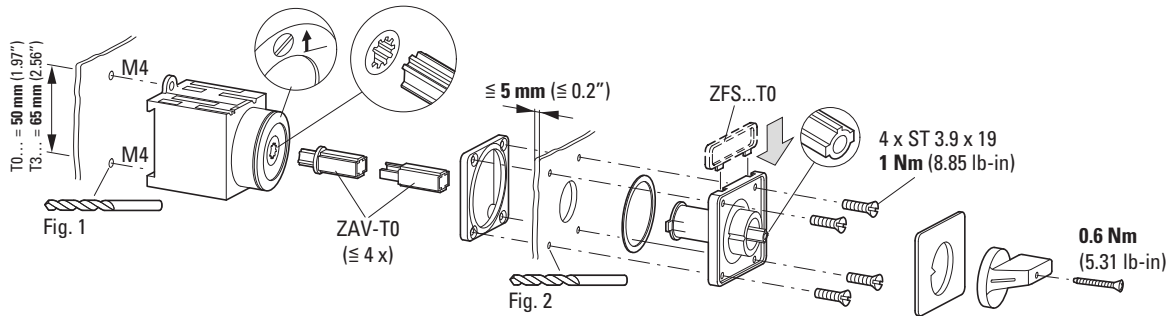

T0(3).../Z



T0(3).../Z/SVB

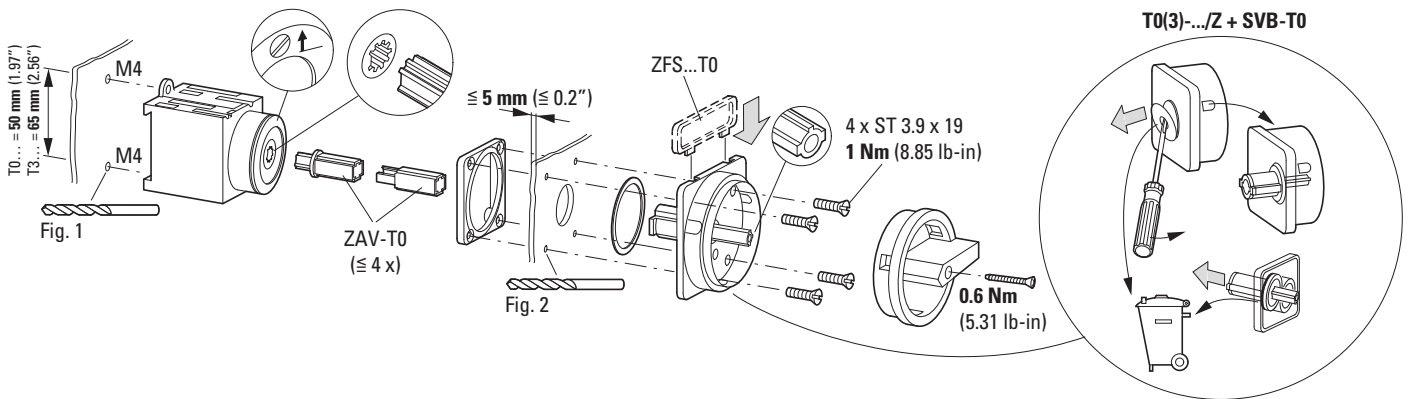

T0(3).../N/SVB

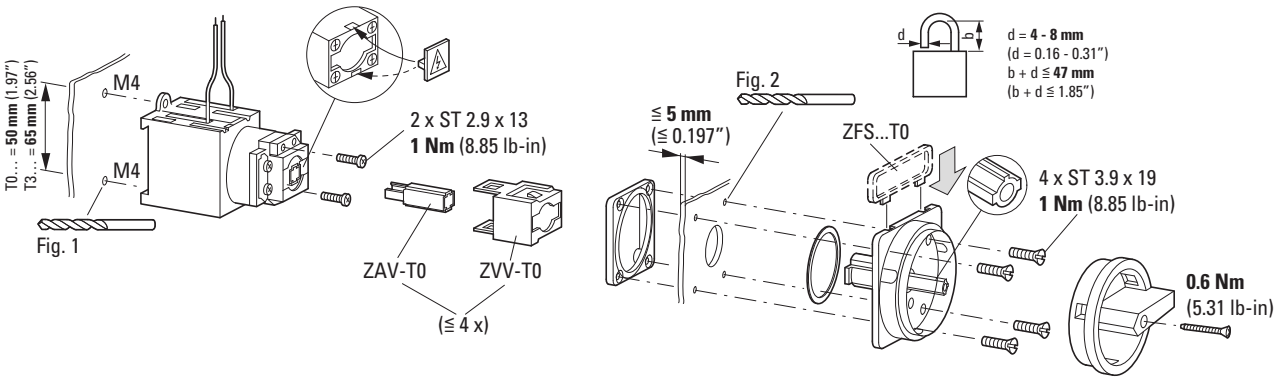

→ ≠ 1:1
T0

→ ≠ 1:1
T3 Fig.1

→ ≠ 1:1
T0 = T3 [mm (in)]

UL/CSA:
Suitable For Use As Motor Branch Circuit Disconnecting Means With Suffix SVB. Break All Lines.
Short Circuit Withstand
10 kA RMS SYM 600 V AC
Max Fuse T0... – 20 A Class J
T3... – 40 A Class J
Standard Short Circuit
5 kA RMS SYM 600 V AC
Max Fuse T0... – 50 A
T3... – 40 A
Max Cir. Bkr. T0... – 50 A
T3... – 125 A
Switch or enclosure must be padlockable if used as a Motor Branch Circuit Disconnecter means.

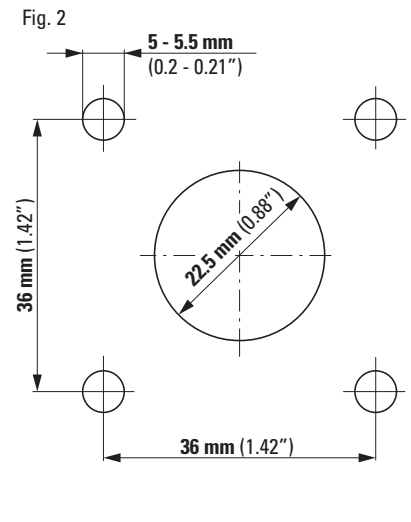
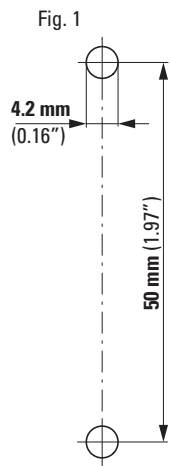

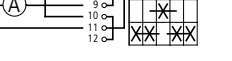
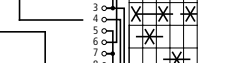
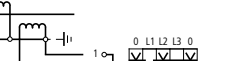
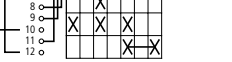
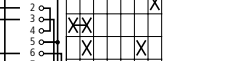
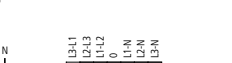
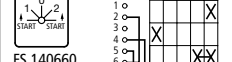
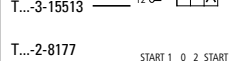
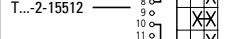
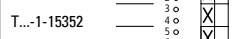
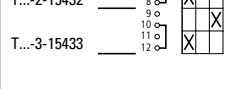
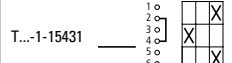
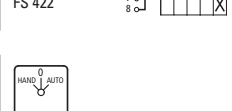
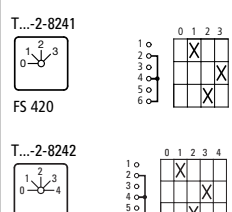
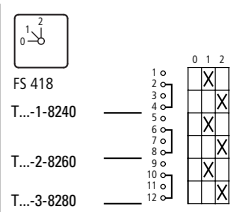
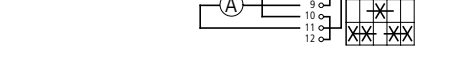
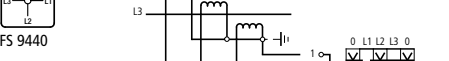
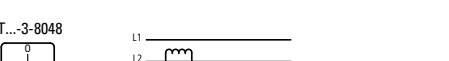
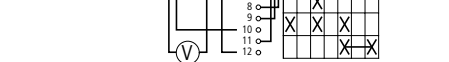
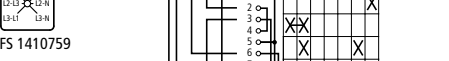
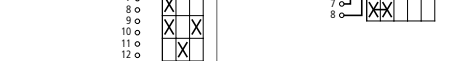
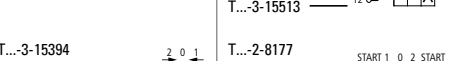
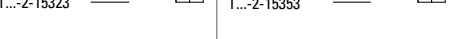
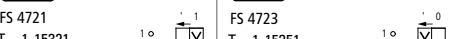
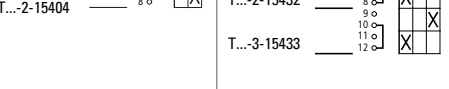
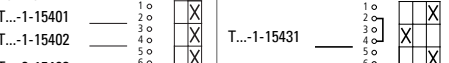
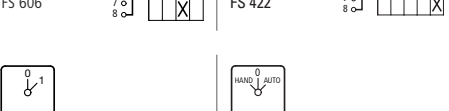
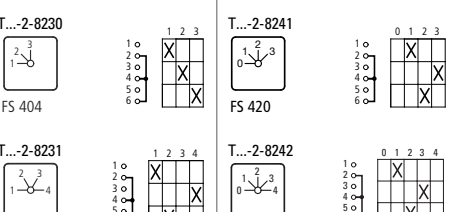
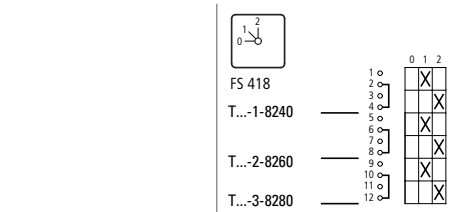
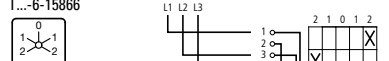
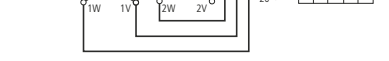
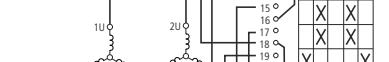
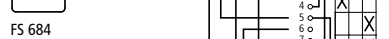
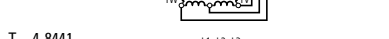
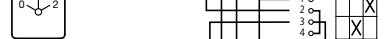
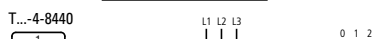
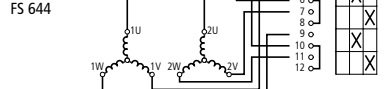
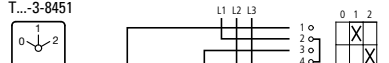
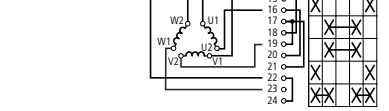
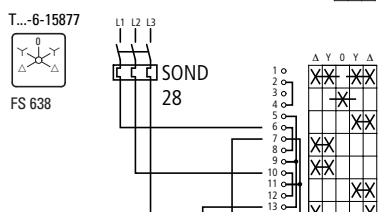
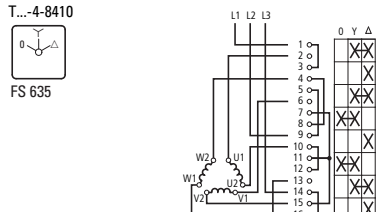
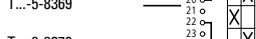
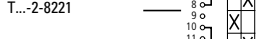
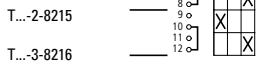
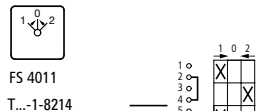
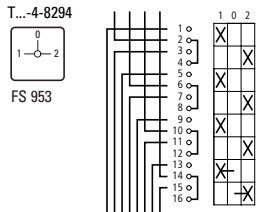
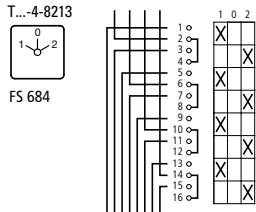
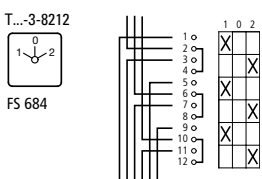
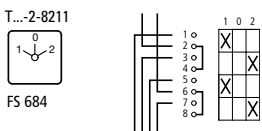
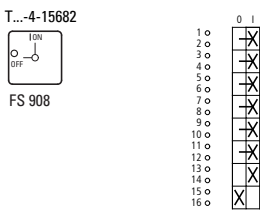
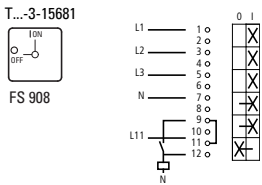
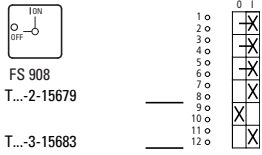
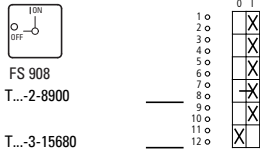
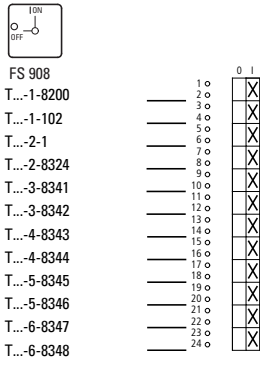

07/16 IL03801021Z