



(en) Electric current! Danger to life!
Only skilled or instructed persons may carry out the following operations.



(de) Lebensgefahr durch elektrischen Strom!
Nur Elektrofachkräfte und elektrotechnisch unterwiesene Personen dürfen die im Folgenden beschriebenen Arbeiten ausführen.



(fr) Tension électrique dangereuse !
Seules les personnes qualifiées et averties doivent exécuter les travaux ci-après.



(es) ¡Corriente eléctrica! ¡Peligro de muerte!
El trabajo a continuación descrito debe ser realizado por personas cualificadas y advertidas.



(it) Tensione elettrica: Pericolo di morte!
Solo persone abilitate e qualificate possono eseguire le operazioni di seguito riportate.



(zh) 触电危险!
只允许专业人员和受过专业训练的人员进行下列工作。



(ru) Электрический ток! Опасно для жизни!
Только специалисты или проинструктированные лица могут выполнять следующие операции.



(nl) Levensgevaar door elektrische stroom!
Uitsluitend deskundigen in elektriciteit en elektotechnisch geïnstrueerde personen is het toegestaan, de navolgend beschreven werkzaamheden uit te voeren.



(da) Livsfare på grund af elektrisk strøm!
Kun uddannede el-installatører og personer der er instruerede i elektrotekniske arbejdsopgaver, må udføre de nedenfor anførte arbejder.



(el) Προσοχή, κίνδυνος ηλεκτροπληξίας!
Οι εργασίες που αναφέρονται στη συνέχεια θα πρέπει να εκτελούνται μόνο από ηλεκτρολόγους και ηλεκτροτεχνίτες.



(pt) Perigo de vida devido a corrente eléctrica!
Apenas electricistas e pessoas com formação electrotécnica podem executar os trabalhos que a seguir se descrevem.



(sv) Livsfara genom elektrisk ström!
Endast utbildade elektriker och personer som undervisats i elektroteknik får utföra de arbeten som beskrivs nedan.



(fi) Hengenvaarallinen jännite!
Vain pätevät sähköasentajat ja opastusta saaneet henkilöt saavat suorittaa seuraavat työt.



(cs) Nebezpečí úrazu elektrickým proudem!
Níže uvedené práce smějí provádět pouze osoby s elektrotechnickým vzděláním.



(et) Eluhtlik! Elektrilöögiolt!
Järgnevalt kirjeldatud töid tohib teostada ainult elektriala spetsialist või elektrotehnilise instrueerimise läbinud personal.



(hu) Életveszély az elektromos áram révén!
Csak elektromos szakemberek és elektrotechnikában képzett személyek végezhetik el a következőkben leírt munkákat.



(lv) Elektriskā strāva apdraud dzīvību!
Tālāk aprakstītos darbus drīkst veikt tikai elektrospeciālisti un darbam ar elektrotehniskām iekārtām instruētās personas!



(lt) Pavojus gyvybei dėl elektros srovės!
Tik elektrikai ir elektrotechnikos specialistai gali atlikti žemiau aprašytus darbus.



(pl) Porażenie prądem elektrycznym stanowi zagrożenie dla życia!
Opisane poniżej prace mogą przeprowadzać tylko wykwalifikowani elektrycy oraz osoby odpowiedzialnie poinstruowane w zakresie elektrotechniki.



(sl) Življenjska nevarnost zaradi električnega toka!
Spodaj opisana dela smejo izvajati samo elektrostrokovnjaki in elektrotehnično poučene osebe.



(sk) Nebezpečnosť ohrozenia života elektrickým prúdom!
Práce, ktoré sú nižšie opísané, smú vykonávať iba elektroodborníci a osoby s elektrotechnickým vzdelaním.



(bg) Опасност за живота от електрически ток!
Операциите, описани в следващите раздели, могат да се извършват само от специалисти-електротехници и инструктиран електротехнически персонал.



(ro) Atenție! Pericol electric!
Toate lucrările descrise trebuie efectuate numai de personal de specialitate calificat și de persoane cu cunoștințe profunde în electrotehnică.



(hr) Opasnost po život uslijed električne struje!
Radove opisane u nastavku smiju obavljati samo stručni električari i osobe koje su prošle elektrotehničku obuku.

DX-COM-STICK DX-COM-STICK2

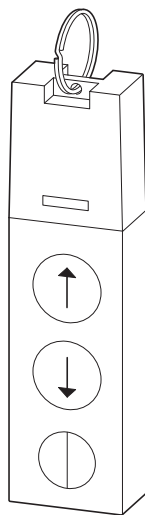

www.eaton.eu/powerxl

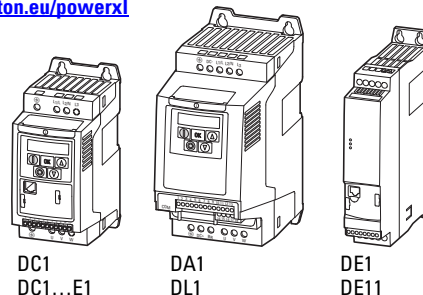

DC1
DC1...E1

DA1
DL1

DE1
DE11

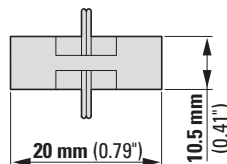
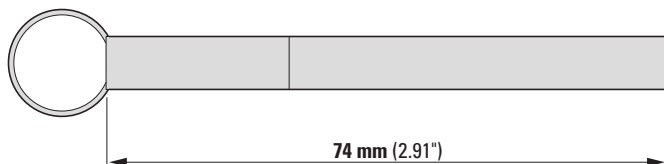

DC1, DC1...E1

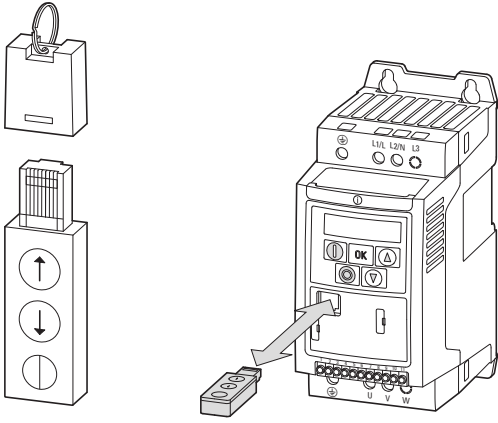

DA1, DL1

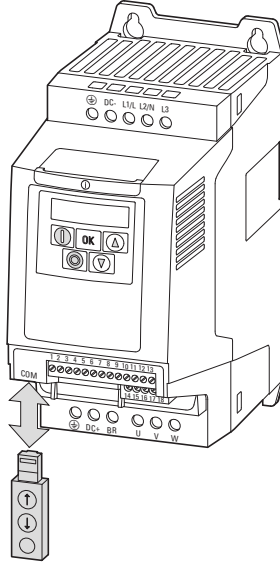

DE1, DE11

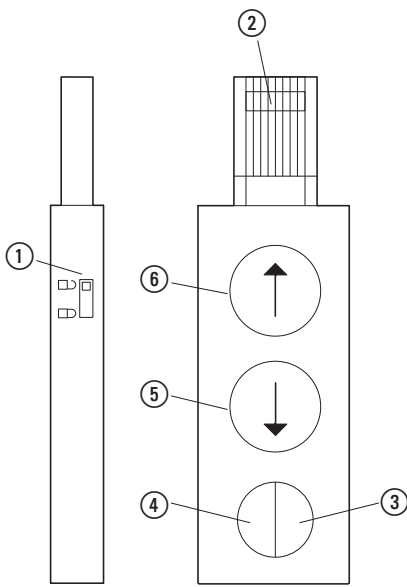
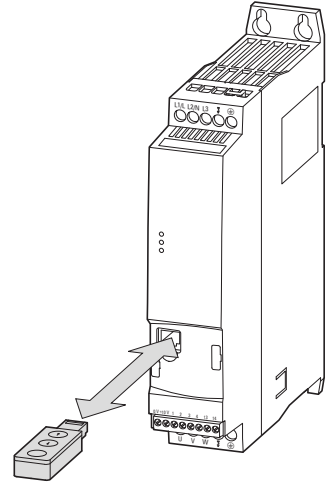

① locks parameters – Parameter geschützt

② RJ45

③ = OK, Ready (green – grün)



Parameter exchange

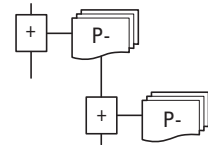
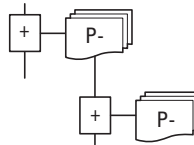

④ = Bluetooth (blue – blau)



= Bluetooth Communication – Kommunikation

⑤ ← Parameter upload

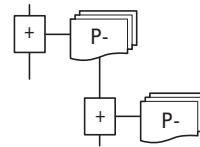

⑥ → Parameter download

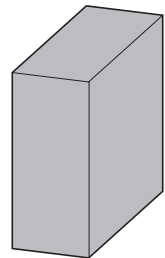
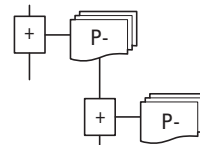

DC1, DC1...E1
DA1, DL1
DE1, DE11

09/16 IL04012021Z

Fault, Error code



PRSS-r	○ Run
DS-Loc	○ Status
FRIL-r	Fault Code
PRSS-t	
FRIL-P	
FRIL-t	
no-dAt	DE1, DE11
dr-Loc	
dr-rUn	
TYPE-E	
TYPE-F	

DC1, DC1...E1
DA1, DL1

Bluetooth Code = 0000

