

Multi-Function Display MFD-Titan



Powering Business Worldwide

All brand and product names are trademarks or registered trademarks of the owner concerned.

Emergency On Call Service

Please call your local representative:

<http://www.eaton.com/moeller/aftersales>

or

Hotline of the After Sales Service:

+49 (0) 180 5 223822 (de, en)

AfterSalesEGBonn@eaton.com

Original Operating Instructions

The German-language edition of this document is the original operating manual.

Translation of the original operating manual

All editions of this document other than those in German language are translations of the original German manual.

1st published 2003, edition date 06/03,

2nd edition 06/04,

3rd edition 05/10,

4th edition 11/10

See revision protocol in the "About this manual" chapter

© 2003 by Eaton Industries GmbH, 53105 Bonn

Production: DHW

Translation: globaldocs GmbH

All rights reserved, including those of the translation.

No part of this manual may be reproduced in any form (printed, photocopy, microfilm or any other process) or processed, duplicated or distributed by means of electronic systems without written permission of Eaton Industries GmbH, Bonn.

Subject to alteration without notice.



Danger! **Dangerous electrical voltage!**

Before commencing the installation

- Disconnect the power supply of the device.
- Ensure that devices cannot be accidentally restarted.
- Verify isolation from the supply.
- Earth and short circuit.
- Cover or enclose neighbouring units that are live.
- Follow the engineering instructions (AWA) of the device concerned.
- Only suitably qualified personnel in accordance with EN 50110-1/-2 (VDE 0105 Part 100) may work on this device/system.
- Before installation and before touching the device ensure that you are free of electrostatic charge.
- The functional earth (FE) must be connected to the protective earth (PE) or to the potential equalisation. The system installer is responsible for implementing this connection.
- Connecting cables and signal lines should be installed so that inductive or capacitive interference does not impair the automation functions.
- Install automation devices and related operating elements in such a way that they are well protected against unintentional operation.
- Suitable safety hardware and software measures should be implemented for the I/O interface so that a line or wire breakage on the signal side does not result in undefined states in the automation devices.
- Ensure a reliable electrical isolation of the low voltage for the 24 volt supply. Only use power supply units complying with IEC 60364-4-41 (VDE 0100 Part 410) or HD 384.4.41 S2.
- Deviations of the mains voltage from the rated value must not exceed the tolerance limits given in the specifications, otherwise this may cause malfunction and dangerous operation.
- Emergency stop devices complying with IEC/EN 60204-1 must be effective in all operating modes of the automation devices. Unlatching the emergency-stop devices must not cause restart.
- Devices that are designed for mounting in housings or control cabinets must only be operated and controlled after they have been installed with the housing closed. Desktop or portable units must only be operated and controlled in enclosed housings.
- Measures should be taken to ensure the proper restart of programs interrupted after a voltage dip or failure. This should not cause dangerous operating states even for a short time. If necessary, emergency-stop devices should be implemented.
- Wherever faults in the automation system may cause damage to persons or property, external measures must be implemented to ensure a safe operating state in the event of a fault or malfunction (for example, by means of separate limit switches, mechanical interlocks etc.).

Contents

0	About This Manual.....	13
0.1	List of revisions	13
0.2	Target group.....	14
0.3	Exclusion of liability	14
0.4	Device designation.....	16
0.5	Writing conventions	17
1	MFD	19
1.1	Proper use.....	19
1.2	Overview of functions.....	19
1.3	Versions	21
1.3.1	Display and operating unit.....	21
1.3.2	Power supply/CPU module	21
1.3.3	I/O module digital/analog.....	22
1.3.4	I/O module with temperature measuring.....	22
1.3.5	LED display	23
1.3.6	Key to part numbers MFD.....	24
1.4	Possible combinations of basic devices and expansion units.....	24
1.5	Extended functionality of MFD-CP10... compared to MFD-CP8.....	27
1.6	MFD operation	28
1.6.1	Key Pad	28
1.6.2	Selecting menus and entering values	28
1.6.3	Status display for the MFD basic device.....	29
1.6.4	Status display for the local expansion module.....	31
1.6.5	Status display additional information.....	31
1.6.6	Menu structure	32
1.6.7	Choosing the main and system menu	32
1.6.8	Main menu without activated password protection.....	33
1.6.9	Main menu with activated password protection.....	33
1.6.10	System menu.....	34
1.6.11	Selecting or toggling between menu items	36
1.6.12	Cursor display.....	36
1.6.13	Setting values.....	37

2	Installation.....	39
2.1	Mounting the MFD	40
2.1.1	Fitting the protective diaphragm/cover on the MFD-80.....	42
2.1.2	Front mounting of the MFD-80 display/HMI unit.....	45
2.1.3	Connecting the power supply/CPU to the display/HMI unit	47
2.1.4	Connecting the input/output module to the power supply unit/ CPU module.....	48
2.1.5	Mounting the MFD-CP8/CP10 on a top-hat rail.....	50
2.1.6	Screwing on the MFD-CP8/CP10.....	53
2.2	Mounting the expansion unit	54
2.2.1	Local expansion module	55
2.2.2	Remote expansion	56
2.3	Terminations	57
2.3.1	Tools	57
2.3.2	Cable cross-sections	57
2.4	Connecting the power supply.....	57
2.4.1	Cable protection.....	57
2.4.2	MFD-AC... power supply unit/CPU module	58
2.4.3	AC expansion unit EASY618-AC-RE.....	58
2.4.4	MFD-... DC power supply/CPU module	59
2.4.5	DC expansion unit EASY...-DC-E	59
2.5	Connecting inputs	60
2.5.1	Connect digital AC inputs.....	61
2.5.2	Connecting easy DC digital inputs	65
2.5.3	Connecting analog inputs.....	69
2.6	Connecting outputs.....	75
2.6.1	Connecting relay outputs	76
2.6.2	Connecting digital transistor outputs	78
2.6.3	Connecting analog outputs	80
2.7	Connecting the easyNET network.....	82
2.7.1	Connection assignment of the RJ45 socket on the device	82
2.7.2	Bus termination resistor.....	83
2.7.3	Pre-assembled easyNet connection cables.....	84
2.7.4	User-assembled easyNet connection cables	84
2.7.5	Fitting and removing easyNet connection cables.....	84
2.7.6	easyNet-topologies.....	85
2.7.7	Cable length with cross-sections	87
2.8	Connecting the serial multi-function interface	88
2.8.1	Connection to a PC	89
2.8.2	Connecting for point-to-point communication.....	91
2.8.3	Inserting the memory card.....	93

3	Commissioning	95
3.1	Switch-on	95
3.2	Setting the menu language	95
3.3	Operating modes	96
3.3.1	RUN, STOP, TERMINAL MODE and BUSY	96
3.4	The first circuit diagram.....	98
3.4.1	Starting point: the status display.....	98
3.4.2	Switching to the circuit diagram.....	99
3.4.3	Draw a wiring diagram	100
3.4.4	Testing the circuit diagram.....	104
3.4.5	Deleting the circuit diagram	106
3.5	I/O module with temperature measuring.....	107
3.5.1	Properties of the temperature modules.....	107
3.5.2	Menu PARAMETERS	108
3.5.3	Menu DIAGNOSTICS	116
3.5.4	Menu INFORMATION.....	116
3.5.5	NEW PARAMETERS...!.....	117
3.6	Configuring the analog expansion unit.....	117
3.6.1	Setting device parameters (IO-DEVICE menu).....	118
3.6.2	Processing analog input/output values.....	120
3.6.3	Diagnostics of an analog expansion unit.....	122
3.7	When controlling a contactor or relay, the control coil is only present once.Commissioning NET stations	122
3.7.1	NET parameterize.....	123
3.7.2	Configuring NET	127
3.7.3	Changing the NET configuration	129
3.7.4	Showing the status display of other NET stations	131
3.8	COM-LINK connection	132
3.8.1	General information on COM-LINK	132
3.8.2	Configuring the interface for COM-LINK.....	133
3.9	Running MFD in Terminal mode	136
3.9.1	MFD as a station of a point-to-point connection	137
3.9.2	MFD as NET station	138

4	Wiring with MFD	145
4.1	MFD operation.....	145
4.1.1	Pushbutton for editing circuit diagrams and function blocks.....	145
4.1.2	Operation.....	145
4.2	Circuit diagram elements.....	146
4.2.1	Program.....	146
4.2.2	Function blocks.....	146
4.2.3	Visualization screens.....	146
4.2.4	Relays.....	147
4.2.5	Contacts and coils of the circuit diagram.....	147
4.2.6	Markers and analog operands.....	152
4.3	Circuit diagram display.....	157
4.4	Program transfer from and to the memory card.....	158
4.4.1	Information on the memory card.....	158
4.4.2	Transfer from/to a device without display or keypad.....	159
4.4.3	Compatibility of program and MFD device.....	159
4.4.4	Loading and saving with a memory card.....	161
4.5	Deleting a program on the card.....	164
4.6	Loading and saving with easySoft-Pro.....	164
4.7	Working with contacts and relays.....	165
4.7.1	Entering and changing contacts and coils.....	166
4.7.2	Creating or changing connections.....	169
4.7.3	Adding or deleting rungs.....	170
4.7.4	Saving circuit diagrams.....	170
4.7.5	Aborting circuit diagram entry.....	170
4.7.6	Searching for contacts and coils.....	171
4.7.7	Got to a rung.....	171
4.7.8	Delete Rung.....	171
4.7.9	Switching with the Cursor Buttons.....	172
4.7.10	Coil Functions.....	174
4.7.11	Jumps.....	177
4.7.12	Wiring NET operands in the circuit diagram.....	179
4.7.13	Read and write of NET operands.....	180
4.7.14	NET operands nRN.. (input) and nSN.. (output).....	181
4.7.15	SN-RN example.....	183
4.7.16	NET operand GT.. (receive), PT.. (send) and SC.. (set date and time).....	184
4.8	Wiring COM-LINK operands in the circuit diagram.....	184
4.8.1	Operand access in the active MFD.....	184
4.8.2	Access method.....	187
4.9	Working with function blocks.....	188
4.9.1	Adding function blocks to the circuit diagram for the first time... ..	189
4.9.2	Setting function block parameters.....	189
4.9.3	Changing function block parameters.....	194
4.9.4	Deleting function blocks.....	196
4.9.5	Checking function blocks.....	196

5	Function blocks	199
5.1	A, analog value comparator/threshold value switch	199
5.1.1	Function block inputs/outputs	199
5.1.2	Wiring of the function block	200
5.1.3	Contacts	200
5.1.4	Parametric programming of the function block inputs/outputs	200
5.1.5	Function of the function block.....	202
5.2	AR, Arithmetic.....	204
5.2.1	Function block inputs/outputs	204
5.2.2	Wiring of the function block	204
5.2.3	Parametric programming of the function block inputs/outputs	205
5.2.4	Function of the function block.....	206
5.3	BC, data block comparator	208
5.3.1	Function block inputs/outputs	208
5.3.2	Wiring of the function block	208
5.3.3	Parametric programming of the function block inputs/outputs	209
5.3.4	Function of the function block.....	211
5.4	BT, Data block Transformer	216
5.4.1	Function block inputs/outputs	216
5.4.2	Wiring of the function block	216
5.4.3	Parametric programming of the function block inputs/outputs	217
5.4.4	Function of the function block.....	220
5.5	BV, Boolean operation.....	228
5.5.1	Function block inputs/outputs	228
5.5.2	Wiring of the function block	228
5.5.3	Parametric programming of the function block inputs/outputs	229
5.5.4	Function of the function block.....	230
5.6	C, counter relay	232
5.6.1	Function block inputs/outputs	232
5.6.2	Wiring of the function block	233
5.6.3	Parametric programming of the function block inputs/outputs	234
5.6.4	Function of the function block.....	236
5.7	CF, frequency counter.....	238
5.7.1	Function block inputs/outputs	238
5.7.2	Wiring of the function block	239
5.7.3	Parametric programming of the function block inputs/outputs	240
5.7.4	Function of the function block.....	242
5.8	CH, high-speed counter	243
5.8.1	Function block inputs/outputs	243
5.8.2	Wiring of the function block	244
5.8.3	Parametric programming of the function block inputs/outputs	245
5.8.4	Function of the function block.....	247
5.9	CI, High-speed incremental value counter	249
5.9.1	Function block inputs/outputs	249
5.9.2	Wiring of the function block	250
5.9.3	Parametric programming of the function block inputs/outputs	251
5.9.4	Function of the function block.....	253

5.10	CP, comparator	255
5.10.1	Function block inputs/outputs.....	255
5.10.2	Wiring of the function block.....	255
5.10.3	Parametric programming of the function block inputs/outputs....	256
5.10.4	Function of the function block	257
5.11	DB, data block.....	258
5.11.1	Function block inputs/outputs.....	258
5.11.2	Wiring of the function block.....	258
5.11.3	Parametric programming of the function block inputs/outputs....	259
5.11.4	Function of the function block	260
5.12	DC, PID controller	261
5.12.1	Function block inputs/outputs.....	262
5.12.2	Wiring of the function block.....	262
5.12.3	Parametric programming of the function block inputs/outputs....	263
5.12.4	Function of the function block	266
5.13	FT, signal smoothing filter.....	268
5.13.1	Function block inputs/outputs.....	268
5.13.2	Wiring of the function block.....	269
5.13.3	Parametric programming of the function block inputs/outputs....	269
5.13.4	Function of the function block	271
5.14	GT, get value from the NET	273
5.14.1	Function block inputs/outputs.....	273
5.14.2	Wiring of the function block.....	273
5.14.3	Parametric programming of the function block inputs/outputs....	274
5.14.4	Function of the function block	275
5.15	HW, weekly timer	276
5.15.1	Function block inputs/outputs.....	276
5.15.2	Function	276
5.15.3	Behavior in the event of a power failure	276
5.15.4	Wiring of the function block.....	277
5.15.5	Parametric programming of the function block inputs/outputs....	277
5.15.6	Operation of the function block	279
5.16	HY - Year Time Switch	282
5.16.1	Function	282
5.16.2	Behavior in the event of a power failure	283
5.16.3	Wiring of the function block.....	283
5.16.4	Parametric programming of the function block inputs/outputs....	283
5.16.5	How the function block works	285
5.16.6	Entry rules.....	285
5.16.7	Sample parameter configurations	287
5.17	JC, conditional jump.....	291
5.17.1	Function block inputs/outputs.....	291
5.17.2	Wiring of the function block.....	291
5.17.3	Parametric programming of the function block inputs/outputs....	292
5.17.4	Function of the function block	292
5.18	LB, jump label	294
5.19	LS, value scaling	295

5.19.1	Function block inputs/outputs	295
5.19.2	Wiring of the function block	295
5.19.3	Parametric programming of the function block inputs/outputs	296
5.19.4	Function of the function block.....	297
5.19.5	Application example	299
5.20	MR, master reset.....	300
5.20.1	Function block inputs/outputs	300
5.20.2	Wiring of the function block	300
5.20.3	Parametric programming of the function block inputs/outputs	301
5.20.4	Function of the function block.....	302
5.21	MX, data multiplexer	303
5.21.1	Function block inputs/outputs	303
5.21.2	Wiring of the function block	303
5.21.3	Parametric programming of the function block inputs/outputs	304
5.21.4	Function of the function block.....	305
5.22	NC, numerical converter	307
5.22.1	Function block inputs/outputs	307
5.22.2	Wiring of the function block	307
5.22.3	Parametric programming of the function block inputs/outputs	308
5.22.4	Function of the function block.....	310
5.23	OT, operating hours counter	312
5.23.1	Function block inputs/outputs	312
5.23.2	Wiring of the function block	312
5.23.3	Parametric programming of the function block inputs/outputs	313
5.23.4	Function of the function block.....	314
5.24	PT - Put value to the NET.....	315
5.24.1	Function block inputs/outputs	315
5.24.2	Wiring of the function block	315
5.24.3	Parametric programming of the function block inputs/outputs	316
5.24.4	Function of the function block.....	318
5.25	PW, pulse width modulation	319
5.25.1	Function block inputs/outputs	319
5.25.2	Wiring of the function block	319
5.25.3	Parametric programming of the function block inputs/outputs	320
5.25.4	Function of the function block.....	322
5.26	SC, set date/time	323
5.26.1	Function block inputs/outputs	323
5.26.2	Wiring of the function block	323
5.26.3	Parametric programming of the function block inputs/outputs	324
5.26.4	Function of the function block.....	324
5.27	SR, shift register	325
5.27.1	Function block inputs/outputs	325
5.27.2	Wiring of the function block	326
5.27.3	Parametric programming of the function block inputs/outputs	328
5.27.4	Function of the function block.....	330
5.28	ST, Set cycle time	337
5.28.1	Function block inputs/outputs	337

5.28.2	Wiring of the function block.....	337
5.28.3	Parametric programming of the function block inputs/outputs....	337
5.28.4	Function of the function block	339
5.29	T, timing relay	340
5.29.1	Function block inputs/outputs.....	340
5.29.2	Wiring of the function block.....	340
5.29.3	Parametric programming of the function block inputs/outputs....	341
5.29.4	Function of the function block	344
5.30	TB, table function.....	350
5.30.1	Function block inputs/outputs.....	350
5.30.2	Wiring of the function block.....	350
5.30.3	Parametric programming of the function block inputs/outputs....	352
5.30.4	Function of the function block	353
5.31	VC, value limitation	355
5.31.1	Function block inputs/outputs.....	355
5.31.2	Wiring of the function block.....	355
5.31.3	Parametric programming of the function block inputs/outputs....	356
5.31.4	Function of the function block	357
5.32	Example with timing relay and counter function block	358
6	Visualization with MFD-Titan	361
6.1	Screens.....	361
6.1.1	Exchangeability of MFD-CP8...- and MFD-CP10... screens	362
6.1.2	Exchangeability of MFD-CP8...- and MFD-CP10... screen elements.....	362
6.1.3	Exchangeability of MFD-CP8...- and MFD-CP10... languages.....	362
6.1.4	Exchangeability of MFD-CP8...- and MFD-CP10... passwords....	362
6.1.5	Replacing an MFD-CP8...- with an MFD-CP10.....	362
6.2	User interface easySoft-Pro	363
6.2.1	Visualization View	363
6.2.2	Simulation View	364
6.2.3	Communication View.....	364
6.3	Screen Overview	365
6.3.1	Register "Screens".....	365
6.3.2	Register „Passwords“	366
6.3.3	Register „Languages“	366
6.3.4	Register „Screen Activation“	367
6.3.5	Current screen tab	369
6.4	Screen Editor	369
6.4.1	Screen memory	370
6.4.2	Creating masks	371
6.4.3	Static Text.....	373
6.4.4	Message Text	375
6.4.5	Screen Menu	382
6.4.6	Running Text.....	383
6.4.7	Rolling Text	384
6.4.8	Latching pushbutton	385
6.4.9	Button Field	386

6.4.10	Bit Display	388
6.4.11	Bitmap	391
6.4.12	Message Bitmap	395
6.4.13	Bar Graph	396
6.4.14	Date and Time Display	398
6.4.15	Numerical value	400
6.4.16	Timing Relay Value Display	405
6.4.17	Value Entry	406
6.4.18	Timing relay value entry	411
6.4.19	Date and time entry	412
6.4.20	Weekly timer inputs	413
6.4.21	Year time switch entry	414
6.5	Button operation on the MFD-Titan	416
6.5.1	Operating principle in the visualization	416
6.6	Button Editor	417
6.6.1	How to Assign a Pushbutton Element to a Pushbutton	418
6.6.2	Select operable screen element	419
6.6.3	Display Backlight	419
6.6.4	Display contrast	420
6.6.5	Screen change	420
6.6.6	Password logout	421
6.6.7	Set variable to fixed value	422
6.6.8	Decrement Variable	423
6.6.9	Increment Variable	424
6.6.10	Changeover relay	426
6.6.11	Disable Change to Status Display	426
6.6.12	P button function	427
6.6.13	Go To Previous Screen	428
6.6.14	Disable Selection Mode	429
6.6.15	Jump Label	429
6.6.16	Conditional Jump	430
6.7	Password Protecting Screens	432
6.7.1	Configure password	432
6.7.2	Language adaption of the title text "PASSWORD ENTRY:"	432
6.7.3	Logout Time	433
6.7.4	Password entry in run	434
6.7.5	Schematic procedure for password entry by the operator	435

7	The network easyNet.....	437
7.1	Introduction network easyNet.....	437
7.1.1	Transfer behavior of the NET stations	438
7.1.2	Functions of the NET stations.....	439
7.1.3	Function "terminal mode"	439
7.2	Description of the NET-PARAMETERS	440
7.2.1	Station number (Station Menu NET-ID)	440
7.2.2	Data transfer speed (Station Menu BAUD RATE).....	440
7.2.3	Pause time, changing the write repetition rate manually (Station Menu BUSDELAY).....	441
7.2.4	Send each change on the inputs/outputs (Station Menu SEND IO)	442
7.2.5	Automatic change of the RUN and STOP mode (Station Menu REMOTE RUN)	443
7.2.6	Configuring an input/output device without its own circuit diagram REMOTE IO menu item)	443
7.3	Network transmission security	444
8	MFD Settings.....	445
8.1	Safety.....	445
8.1.1	Password protection	445
8.1.2	Inputting a password	445
8.1.3	Activating Passwords.....	447
8.1.4	Unlocking MFD	448
8.1.5	Changing passwords.....	448
8.1.6	Delete password.....	449
8.1.7	Password no longer known or incorrect	449
8.2	System.....	450
8.2.1	Switching on the input delay function (Debounce menu)	450
8.2.2	P PUSHBUTTONS.....	451
8.2.3	Setting the startup behavior.....	452
8.2.4	TERMINAL MODE startup (TERMINAL MODE menu item)	454
8.2.5	Activating external buttons (I-BUTTONS and R-BUTTONS menu items).....	455
8.2.6	Setting contrast and backlight (DISPLAY menu item).....	456
8.2.7	Storing data retentively (Retention menu item...)	458
8.3	Menu language	461
8.3.1	Changing the menu language	461
8.4	Configurator	462
8.4.1	NET	462
8.4.2	COM	462
8.4.3	LINK	463
8.4.4	Configuring analog expansion units	463
8.4.5	Configure communication expansion unit.....	463
8.4.6	ETHERNET-GW.....	463

8.4.7	IO MODULES.....	464
8.5	Setting time.....	464
8.5.1	Setting time and date.....	464
8.5.2	Summer/winter time	464
9	Inside MFD	469
9.1	MFD Program.....	469
9.1.1	How the MFD device evaluates circuit diagrams and function blocks	469
9.1.2	Cycle-time monitoring	470
9.1.3	What you must consider when creating the circuit diagram.....	471
9.1.4	Allowing for the special feature of certain function blocks	472
9.1.5	What affects the cycle time of an MFD device.....	472
9.1.6	MFD memory management.....	473
9.2	Time behavior of the inputs and outputs	474
9.2.1	Input delay (debounce).....	474
9.2.2	Delay time with MFD DC basic devices.....	475
9.2.3	Delay time with MFD AC basic devices	476
9.3	Diagnostics.....	479
9.3.1	Diagnostics using the ID diagnostics contact	479
9.3.2	Checking the transistor output for short-circuit/overload	480
9.4	Expanding an MFD device	481
9.4.1	How is an expansion unit detected?	482
9.4.2	easyLink transfer behavior.....	482
9.4.3	Monitoring the functionality of the expansion unit.....	482
9.5	Monitoring the serial multi-function interface	483
9.6	Monitoring the COM-LINK connection.....	483
9.7	Displaying device information	484
9.8	Device Version Number	485
10	What Happens If ...?	487
10.1	Messages from the MFD operating system	487
10.2	Possible situations when creating circuit diagrams	488
10.3	Event	489
10.4	Functionality of the NET faulty	489
10.4.1	Monitoring via diagnostics bits.....	490
10.5	Replacing a NET station	491
10.6	Power supply failure on station with NET-ID 1	492

11	Appendix.....	493
11.1	Approval and Certification	493
11.1.1	Approvals and national approvals for MFD devices	493
11.1.2	Shipping approvals for MFD devices	493
11.1.3	Approvals and national approvals for expansion devices	494
11.1.4	Shipping approvals for easy6.. expansion devices	494
11.2	Dimensions	495
11.2.1	MFD-80.. display/operator unit.....	495
11.2.2	Power supply unit/CPU MFD-CP8.....	496
11.2.3	Input/output modules MFD-R.. , MFD-T.....	497
11.2.4	MFD-80-XM protective diaphragm.....	497
11.2.5	MFD-80-XS protective cover.....	498
11.3	Technical data	499
11.3.1	Standards	499
11.3.2	General ambient conditions	499
11.3.3	Display/operating unit	501
11.3.4	Power supply	502
11.3.5	Central processing unit, real-time clock/timing relay/memory	503
11.3.6	Inputs.....	505
11.3.7	Analog output	514
11.3.8	NET easynetwork	515
11.4	List of function blocks.....	516
11.4.1	Function block coils.....	517
11.4.2	Function block contacts	518
11.4.3	Function block inputs (constants, operands).....	519
11.4.4	Function block output (operands).....	520
11.4.5	Other operands	520
11.5	Memory requirement.....	520
11.6	Basic and extended Western European character set.....	522
11.7	Central European expansion character set	524
11.8	Cyrillic expansion character set.....	525
	Index	527

0 About This Manual

This manual describes the installation, commissioning and programming (circuit diagram creation) of the MFD combined visualization device and control relay.

Specialist electrical training is needed for commissioning and creating circuit diagrams.



DANGER

If active components are controlled, such as motors or pressurized cylinders, plant plants may become damaged or persons endangered, provided MFD is incorrectly connected, or incorrectly configured and programmed.

The latest edition of this manual can be obtained from the Internet at:

<ftp://ftp.moeller.net/index.html>

0.1 List of revisions

This edition was fully revised. The following table therefore only lists major modifications.

Publication date	Page	Key word	New	Change	omitted
11/10					
	161	Double sized memory card for MFD-CP10...		✓	
	303	"Multiplexer" function block, MX for MFD-CP10...	✓		
	361	Program examples for screen elements		✓	
	366	16 download languages on MFD-CP10...	✓		
	453	CARD MODE		✓	
	458	Increased memory on MFD-CP10... for retentive data		✓	
	473	Increased program and screen memory on MFD-CP10..		✓	
	417	"Display contrast" button element for MFD-CP10...	✓		
	427	P button function possible on all operator buttons of the MFD-CP10...	✓		
	458	Increased retentive range on MFD-CP10..		✓	

0.2 Target group

A MFD device may only be fitted and connected by a qualified electrician or a person who is familiar with electrical installations.



DANGER

Specialist electrical training is needed for creating circuit diagrams and commissioning. Plant sections and persons are at risk if a MFD device is incorrectly connected or programmed and active components such as motors or pressure cylinders are controlled.

0.3 Exclusion of liability

All information in this manual was provided by us to the best of our knowledge and belief and in accordance with the current state-of-the-art. However, inaccuracies cannot be totally excluded, and we therefore do not assume any liability for the accuracy or completeness of this information. This information in particular does not contain any guarantee for the provision of specific properties.

The devices described must only be installed and operated in accordance with the content of this operator manual and the installation instructions provided with the device. Mounting, commissioning, operation, maintenance and refitting of the devices must only be carried out by qualified persons. The devices must only be used in the areas recommended and only in conjunction with third-party devices and components that have been approved by us. Their use is allowed fundamentally only in technically faultless condition. Fault-free and safe operation of the system requires proper transport, storage, mounting and commissioning as well as careful operation and maintenance. If the following safety instructions are not observed, particularly with regard to commissioning and maintenance of the devices by insufficiently qualified personnel and/or in the event of improper use of the devices, any hazards caused by the devices cannot be excluded. We cannot accept any liability for any resulting injury or damage.

The use of such sample programs and of the easySoft-Pro programming software are subject to the following safety instructions and operating guidelines:

1. The program examples provided were created to the best of our knowledge and belief and in accordance with the current state-of-the-art. However, errors cannot be totally excluded, and the example programs do not cover all function blocks and applications that are available for the easy800-/MFD-CP8.../CP10... devices.
2. A specialist knowledge of electrical engineering is needed for the programming and commissioning of easy800-/MFD-CP8.../CP10... devices. Plant sections and persons are at risk if an easy800-/MFD-CP8.../CP10... device is incorrectly connected or configured and active components such as motors or pressure cylinders are controlled.

3. When using the provided sample programs and generating a program with easySoft, the user has the sole responsibility to observe the following:

- All relevant regulations regarding the preparation of a circuit diagram for easy800-/MFD-CP8.../CP10... devices according to the updated user manuals of easy800-/MFD-CP8.../CP10... devices.
- All relevant regulations, directives, rules and standards of occupational safety and accident prevention regarding the intended preparation of circuit diagrams, initial commissioning and the operation of easy800-/MFD-CP8.../CP10... devices, particularly those issued by Employers' Liability Insurance Associations (Berufsgenossenschaften).
- Acknowledged rule of technology and state of science.
- All other general due diligence regarding the prevention of damages to life and physical condition of persons as well as material damage.

4. The manufacturer cannot accept any liability for any damages that are caused by customers not using the example programs provided in accordance with the conditions of use specified under points 1 to 3.

0.4 Device designation

The following terms are used for the device types if the description applies to all these types:

- easy600 for
 - EASY618-.C-RE
 - EASY620-DC-TE
- easy500/700 for
 - all EASY5...-... and
 - all EASY7...-...
- easy800 for
 - EASY819-...,
 - EASY820-...,
 - EASY821-...,
 - EASY822-...
- MFD-Titan for
 - all components belonging to the Multi-function display family consisting of power supply/CPU module (MFD-CP...) or power supply/communication module (MFD-CP4...), display/operator unit (MFD-80...) and I/O module.
- MFD for
 - the programmable devices (visualization devices), consisting of power supply/CPU module (MFD-...-MFD fCP8.../CP10...), display/operator unit (MFD-80...) and I/O module.
- MFD-CP8.../CP10... for
 - the programmable MFD-CP8..., MFD-AC-CP8... and MFD-CP10.... power supply/CPU modules
- MFD-CP8... for
 - the MFD-CP8... and MFD-AC-CP8... power supply/CPU modules including the easyNet-compatible modules.
- MFD-CP10... for
 - the MFD-CP10-ME and the MFD-CP10-NT easyNet-compatible module.
- MFD-...-NT for
 - easyNet-compatible power supply/CPU modules
- MFD-CP4... for
MFD-CP4... and MFD-AC-CP4... power supply unit/communication modules
- easy-AC for
 - EASY8...-AC-...
 - EASY618-AC-RE
- easy-DC for
 - EASY6...-DC-TE
 - EASY8...-DC-...

0.5 Writing conventions

Symbols used in this manual have the following meanings:

▶ indicates actions to be taken.

CAUTION

Warns about the possibility of material damage.



WARNING

Warns of the possibility of hazardous situations that may possibly cause injury.



WARNING

Warns of the possibility of hazardous situations that could result in serious or even death.



DANGER

Warns of hazardous situations that result in serious injury or death.



Draws your attention to interesting tips and supplementary information.

For greater clarity, the name of the current chapter is shown in the 1. headline and the name of the current section in the 2. headline.

0 About This Manual
0.5 Writing conventions

1 MFD

1.1 Proper use

An MFD is a programmable display, operator, switching, closed-loop and open-loop control device that enables the replacement of relay and contactor control circuits as well operator and display units. The device has a modular design and can be used in different combinations:

- Power supply unit/CPU module + Input/output module (I/O module)
- Power supply unit/central processing unit + display /operating unit
- Power supply unit/central processing unit + display/operating unit + I/O module

It is also possible to use an expansion unit with all combinations.

The MFD device is a mounted device and must be installed in an enclosure, control cabinet or service distribution board with protection type IP54 or higher.

The display and HMI device is protected to IP65 and normally does not require any special housing protection. The rear-mounted "power supply/CPU module", "I/O module" and "expansion units" are built-in devices and must be installed in a housing, a switch cabinet or a service distribution board.

Power supply and signal terminals must be protected against accidental contact and covered.

The MFD device may only be operated if it has been correctly fitted and connected by qualified electrical specialists. The installation must comply with regulations for electromagnetic compatibility (EMC).



DANGER

The power up of the MFD device must not cause any hazards arising from activated devices, such as unexpected motor startups or power ups.

The MFD device should not be used as a substitute for safety-related controls such as burner controls, emergency-stop or two-hand safety controls.

1.2 Overview of functions

The MFD is an electronic display and operator unit and control relay. It is equipped with:

- Logic functions
- Timing relay and counter functions
- Time switch functions
- Arithmetic functions

1 MFD

1.2 Overview of functions

- PID controllers
- Integrated display and operating elements.

With MFD-CP8.../CP10... you can create solutions for domestic applications as well as for tasks in machinery and plant construction. MFD-CP8.../CP10... is a modular and flexible device.

The integrated easyNet network makes it possible to connect up to eight NET stations to a PLC. All devices with a NET terminal connection can be used as NET stations. At present these devices consist of easy800/MFD-CP8.../CP10..., easySafety devices or type XC200/EC4-200 PLCs.

Each Net station can process its own circuit diagram and a visualization application. This allows the design of systems using high-speed controllers with decentralized intelligence.

Each Net station can process its own circuit diagram and a visualization application. This allows the design of systems using high-speed controllers with decentralized intelligence.

With easy you can create a circuit diagram in ladder diagram. The circuit diagram entry can be carried out directly on the device using the operator buttons or on your PC using the easySoft-Pro programming software.

For example, you can:

- Connect N/O and N/C contacts in series and in parallel
- Connect output relays and markers.
- Define outputs as coils, impulse relays, rising or falling edge-triggered relays or as latching relays.

The function blocks provide you with several functions such as arithmetic functions, value comparison functions or up/down counting. All function blocks provided are listed in alphabetical order in the Appendix on page 516. The cross-references provide links to detailed descriptions of these function blocks.

If you wish to wire an MFD via your PC, i.e. create a circuit diagram, use the easySoft-Pro programming software.

easySoft-Pro also allows you to:

- test your circuit diagram by simulating the power flow (offline test).
- create your visualization device (exclusively with easySoft-Pro), consisting of screens and their association with the circuit diagram.
- transfer a program consisting of circuit diagram and visualization to a connected and operational MFD-CP8.../CP10....
- after the transfer, follow the power flow and view the operand states after the transfer during operation (online test)
- print out and thus fully document your circuit diagram in different formats (e.g. DIN; ANSI or easy format).

You enter your password to protect your know-how.

1.3 Versions

1.3.1 Display and operating unit

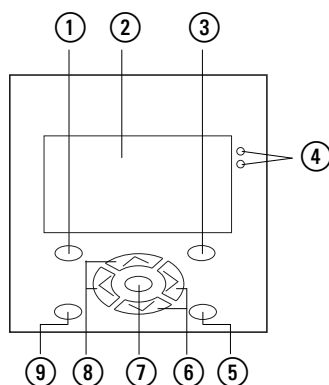

Figure 1: Overview of the display and operating unit

- ① DEL pushbutton
- ② Graphic display
- ③ ALT pushbutton
- ④ LEDs for signalling
- ⑤ Mode pushbutton
- ⑥ Right and down cursor buttons
- ⑦ OK Button
- ⑧ Left and up cursor buttons
- ⑨ ESC button

1.3.2 Power supply/CPU module

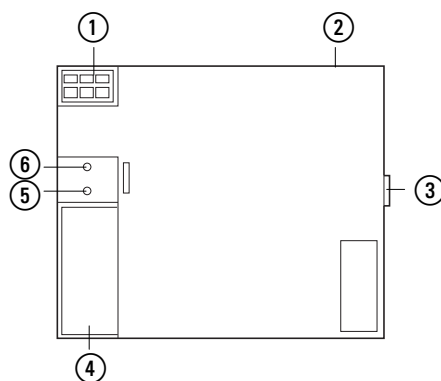

Figure 2: Device overview of power supply/CPU module

- ① Power supply → Page 57
- ② NET terminals → Page 60
- ③ easyLink connection → Page 54
- ④ Serial multi-function interface for memory card, PC connection or point-to-point connection, → Page 88
- ⑤ LED NET (easyNet) → Page 23
- ⑥ LED POW/RUN (supply voltage, operating mode) → Page 23

1.3.3 I/O module digital/analog

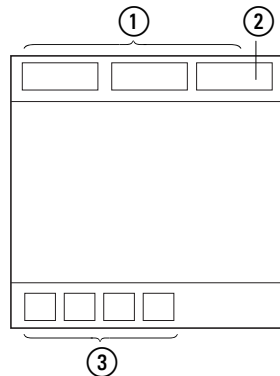

Figure 3: Device overview of MFD-R.16(17) and MFD-T.16(17) standard I/O module

- ① Inputs, → Page 60
- ② Analog output (optional), → Page 80
- ③ Digital relay outputs or transistor outputs with 24 V DC supply voltage
→ Section „Connecting relay outputs“, page 76
→ Section „Connecting digital transistor outputs“, page 78

1.3.4 I/O module with temperature measuring

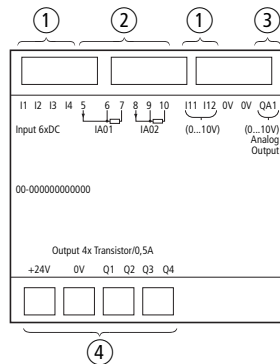

Figure 4: Device overview MFD-TP.../MFD-TAP... I/O module with temperature measuring

- ① Digital inputs, → Page 61
- ② resistance sensor inputs, → Page 74
- ③ Analog output 0-10 V DC (MFD-TAP...), → Page 80
- ④ Digital relay outputs or transistor outputs with 24 V DC supply voltage
→ Section „Connecting relay outputs“, page 76
→ Section „Connecting digital transistor outputs“, page 78

1.3.5 LED display

Rear LEDs

An MFD-CP8.../CP10... is provided with two LEDs on the rear (→ Figure 1, page 21):

- POW/RUN and
- NET.

The POW/RUN LED indicates the state of the POW power supply as well as the RUN or STOP state.

Table 1: LED POW/RUN

LED off	No supply voltage
LED continuously light	STOP operating mode, supply voltage present.
LED flashing (0.5 Hz)	RUN operating mode, supply voltage present.

The NET LED provides information on the status of the Net (→ Section „Functionality of the NET faulty“, page 489).

Table 2: LED NET (easyNet)

LED off	NET not operational, fault in configuration.
LED continuously lit	Fault! Net is initialized but at least one station has not been detected.
LED flashing (0.5 Hz)	NET operating fault-free

The MFD is also provided with two front LEDs.

Front LEDs

A green and a red LED is provided on the front of the display/operating unit of an MFD-80.... These LEDs have a different meaning depending on the application:

- Visualization Application

You can use these LEDs as indicators in your visualization application. For this wire the LEDs in the circuit diagram via the output operands LE2 (red) and LE3 (green).

- Terminal Mode

If you are running the MFD in Terminal mode, these LEDs will indicate the operating state of the remotely controlled devices. Additional information → Section „Running MFD in Terminal mode“ from page 136.

Table 3: Green LED: Power supply/operating mode of the remotely controlled device

Green LED	Meaning
OFF	The remotely controlled device has no supply voltage. The interruption of the connection is shown in the display at the same time.
continuous light	The remotely controlled device is in STOP mode, power supply is present.
Flashing	The remotely controlled device is in RUN operating mode, supply voltage is present.

1 MFD

1.4 Possible combinations of basic devices and expansion units

Table 4: Red LED: Status for Terminal mode via easyNET

Red LED	Meaning
OFF	Operation correct
continuous light	The NET connection to the remotely controlled device is interrupted.

1.3.6 Key to part numbers MFD

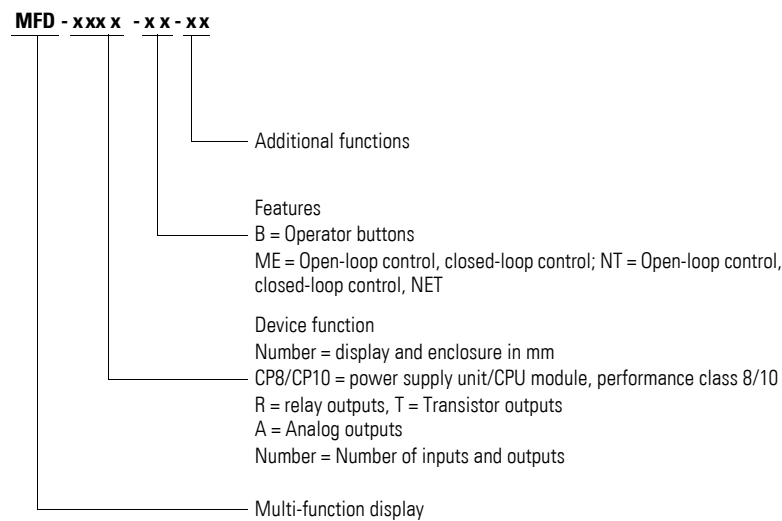

1.4 Possible combinations of basic devices and expansion units

The following table shows the possible combinations of basic units and expansion devices. Possible combinations are marked with a reference to the description page.

	MFD-CP8.../MFD-CP10... power supply unit/CPU module					MFD-AC-CP8...						
	Digital Inputs		Outputs		Analog	Digital Inputs		Outputs		Analog		
	100 V - 240 V AC	24 V DC	Transistor	Relays	Inputs	Outputs	100 V - 240 V AC	24 V DC	Transistor	Relays	Inputs	Outputs
Standard I/O module												
MFD-AC-R16	-	-	-	-	-	-	✓ (S. 61)	-	-	✓ (S. 76)	-	-
MFD-R16	-	✓ (S. 65)	-	✓ (S. 76)	✓ (S. 70)	-	-	-	-	-	-	-
MFD-T16	-	✓ (S. 65)	✓ (S. 78)	-	✓ (S. 70)	-	-	-	-	-	-	-
MFD-RA17	-	✓ (S. 65)	-	✓ (S. 76)	✓ (S. 70)	✓ (S. 80)	-	-	-	-	-	-
MFD-TA17	-	✓ (S. 65)	✓ (S. 78)	-	✓ (S. 70)	✓ (S. 80)	-	-	-	-	-	-

1.4 Possible combinations of basic devices and expansion units

	MFD-CP8.../MFD-CP10... power supply unit/CPU module						MFD-AC-CP8...					
	Digital			Analog			Digital			Analog		
	Inputs		Outputs	Inputs		Outputs	Inputs		Outputs	Inputs		Outputs
	100 V - 240 V AC	24 V DC	Transistor	Relays			100 V - 240 V AC	24 V DC	Transistor	Relays		
I/O module with temperature measuring												
MFD-TP12...	-	✓ (S. 66)	✓ (S. 78)	-	✓ (S. 72)	-	-	-	-	-	-	-
MFD-TAP13...	-	✓ (S. 66)	✓ (S. 78)	-	✓ (S. 72)	✓ (S. 80)	-	-	-	-	-	-
Expansion Units												
EASY618-AC-RE	✓ (S. 62)	-	-	✓ (S. 77)	-	-	✓ (S. 62)	-	-	✓ (S. 77)	-	-
EASY618-DC-RE	-	✓ (S. 68)	-	✓ (S. 77)	-	-	-	✓ (S. 69)	-	✓ (S. 77)	-	-
EASY620-DC-TE	-	✓ (S. 68)	✓ (S. 78)	-	-	-	-	✓ (S. 69)	✓ (S. 78)	-	-	-
EASY410-DC-TE	-	✓ (S. 68)	✓ (S. 78)	-	-	-	-	✓ (S. 69)	✓ (S. 78)	-	-	-
EASY410-DC-RE	-	✓ (S. 68)	-	✓ (S. 77)	-	-	-	✓ (S. 69)	-	✓ (S. 77)	-	-
EASY406-DC-ME	-	✓ (S. 69)	✓ (S. 78)	-	✓ (S. 73)	✓ (S. 81)	-	✓ (S. 69)	✓ (S. 78)	-	✓ (S. 73)	✓ (S. 81)
EASY411-DC-ME	-	✓ (S. 69)	✓ (S. 78)	-	✓ (S. 73)	✓ (S. 81)	-	✓ (S. 69)	✓ (S. 78)	-	✓ (S. 73)	✓ (S. 81)
EASY202-RE	-	-	-	✓ (S. 77)	-	-	-	-	-	✓ (S. 77)	-	-

1 MFD

1.4 Possible combinations of basic devices and expansion units

Table 5: Available expansion units

Catalog No.	Inputs						Outputs			Note
	Digital	Analog	number of which can be used as...				Relays	Transistor	Analog	
			24 V DC	100-240 V AC	Total	0 - 10 V, 10 Bit				
EASY202-RE							2			common ¹⁾
EASY410-DC-RE	6						4			
EASY410-DC-TE	6							4		
EASY406-DC-ME	1	2	2 ³⁾	2	2	2 ⁴⁾		2	1	up to 2 analog inputs simultaneously, 4 diagnostics bits (R13...R16)
EASY411-DC-ME	1	6	2 ³⁾	2	2	2 ⁴⁾		2	2	up to 6 analog inputs simultaneously, 4 diagnostics bits (R13...R16),
EASY618-AC-RE		12					6			
EASY618-DC-RE		12					6			
EASY620-DC-TE		12						8		

- 1) Common supply for multiple outputs
- 2) Can also be used as digital inputs R2/R3
- 3) Digital inputs R2/R3 for evaluation of the 0 - 10 V voltage inputs

Special expansion units for connecting to other bus systems are shown in the latest main catalog.

1.5 Extended functionality of MFD-CP10... compared to MFD-CP8...

The MFD-CP10... is an upwardly compatible further development of the MFD-CP8.... All the functions of the MFD-CP8... are provided to the exactly the same extent in the MFD-CP10....

The following are the major additions compared to MFD-CP8...:

- doubling of the program memory, see page 473
- doubling of the screen memory, see page 473
- doubling of the retentive memory, see page 458
- doubling of the memory card capacity, see page 161
- increased program processing speed and
- possibility of an operating system update.

The MFD-CP10... also features:

- the ability to store text elements in up to 16 different languages which can be selected with a program command when the screen is displayed, see page 366
- a new Display contrast button element, see page 420
- the possibility to assign all operating buttons with the P button function and thus to use P buttons P01 - P09 in the program, see page 172
- the MX Multiplexer function block, see page 303.

1 MFD

1.6 MFD operation

1.6 MFD operation

1.6.1 Key Pad









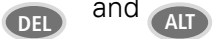

- DEL: Delete object in circuit diagram
- ALT: Special functions in circuit diagram, status display
- Cursor buttons <> ^ ∨:
 - Move cursor
 - Select menu items
 - Change numbers, contacts and values
- OK: Next menu level, Save your entry
- ESC: Back, Cancel
- *: Toggle between visualization display and status display, Close Terminal mode

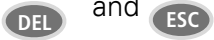

In visualization applications, the keypad of the operating unit can be used for other functions than the ones stated above (→ Chapter 6 "Visualization with MFD-Titan" on page 361). In this case the buttons are assigned the function selected in the application. The standard button functions are only restored when you leave the visualization application.

1.6.2 Selecting menus and entering values

	P button function
 and 	Calling the System menu
	Move to next menu level Call menu item [P05] Activate, change, store entries
	Move to previous menu level [P06] Cancel entries since last OK
	[P07]
	[P08]
	[P09] ^ Change menu item ∨ Change value <> Change place P spring-return: < Input P01 ^ Input P02 > Input P03 ∨ Input P04
 and 	Reset the MFD display

P buttons in square brackets [P..] are only available on the MFD-CP10...

1.6.3 Status display for the MFD basic device

After power on, the MFD shows the status display of the basic device. The status display has four lines. If a local expansion is connected, press OK to show the status display of the local expansion in the display (→ Page 31).

Pressing ALT allows you to change the content of line 2 and 3 and the status display of the basic device as well as the local expansion.



When operating the MFD as a NET station you can press ESC to switch from the status display and select another NET station. You can then display the status of the inputs and outputs of the other NET station (→ Section „Showing the status display of other NET stations“, page 131).

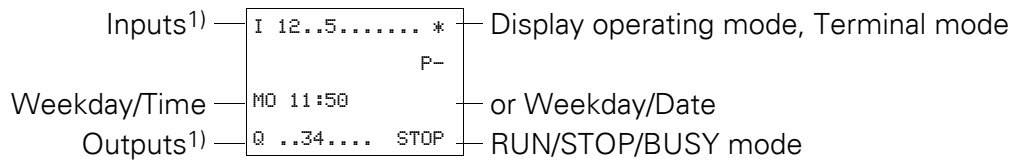

1) On: I1, 2, 5 and Q3, 4
Off:...

Figure 5: Status display when you switch on

1 MFD

1.6 MFD operation

1.6.3.1 Lines 1 and 4: Inputs/outputs

```
I 12..5.....  
MO 11:50  
Q ..34.... STOP
```

Line 1 shows the status of the basic device inputs.

Line 4 shows the basic device outputs and its operating mode (RUN, STOP or BUSY).

→ Section „Operating modes“, page 96.

1.6.3.2 Line 2: System information, diagnostics

You can change the content of line 2 (and 3) by pressing ALT. After the initial power up, the MFD device indicates with P- that the cursor buttons (P buttons) are not active and therefore cannot be used as button inputs in the standard circuit diagram. Active P buttons are indicated with P+ (→ Section „P PUSHBUTTONS“, page 451). The will show further system information MFD in line 2 (→ Section „Status display additional information“, page 31) depending on the parameters and the peripheral devices connected.

Starting from the initial status display, you can press ALT twice to show the following diagnostics messages in line 2 and 3:

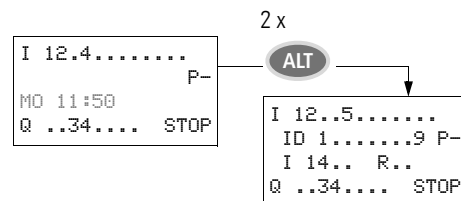

- Line 2: status of the local diagnostics bits ID1...ID9 and P-/+.
- Line 3: Status of the local diagnostics bit I14...I16 as well as R15 and R16.

1.6.3.3 Line 3: Weekday, time/date, diagnostics

In the initial status display, line 3 shows the weekday and the time.

Pressing ALT displays the weekday and date in line 3.

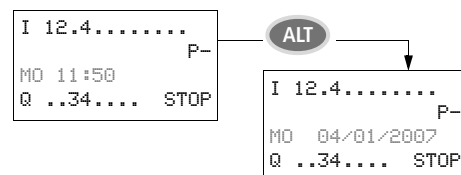

1.6.4 Status display for the local expansion module

Press OK to move from the status display for the MFD basic device to the status display for the local expansion module if the latter is being operated via the easyLink connection. Pressing ALT allows you to switch the content of line 2 and 3 in the status display.

1.6.4.1 Lines 1 and 4: Inputs/outputs

```
R 12..5.789..12
RS                P-
MO 11:50
S 12.....8 STOP
```

Line 1 shows the status of inputs R of the local expansion module and line 4 that of outputs S. In addition line 4 indicates the basic devices operating mode.



Apart from the ID RS in line 2, by which a connected functional expansion unit is indicated, lines 2 and 3 indicate the same contents for basic and expansion units.

Press ALT once therefore to show in line 2 the weekday and the date, and press ALT twice to show also in line 2 and 3 the same diagnostic alarms as in the status display for the basic device.

1.6.5 Status display additional information

Depending on the additional parameters set (e.g. retentive operands) or the connected peripheral devices (e.g. when running as an Net station) the system information listed below is also shown in the status display.

Retention/debounce/ NET station	<pre>I 12...6.89..12 RE I NT1 AC P- MO 11:50 ST Q 12345678 RUN</pre>	AC expansion OK/P buttons off Start behavior
------------------------------------	--	---

System information

RE : Retention active or RS: Local expansion operating correctly
 I : Debounce switched on
 NT1: NET stations with Net-ID (1 this case)
 COM COM connection active
 AC : AC expansion functioning correctly or
 DC : DC expansion functioning correctly
 GW : Expansion of part no. Gateway detected, that is used for communication between other bus systems or for processing analog values and temperatures.
 GW flashes: Only EASY200-EASY, but no connected I/O expansion.
 ST : When the power supply is switched on, the MFD switches to STOP mode

How to show the status display of other NET stations is described in
 → Section „Showing the status display of other NET stations“, page 131)

1 MFD

1.6 MFD operation

1.6.6 Menu structure

The MFD has two different menu structures, the main menu and the system menu.

The main menu provides the most frequently required functions during operation.

The system menu is used for entering global device parameters.

1.6.7 Choosing the main and system menu

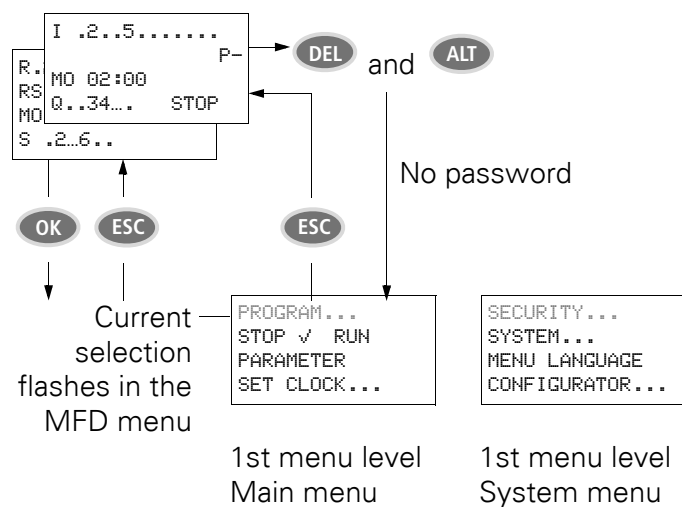
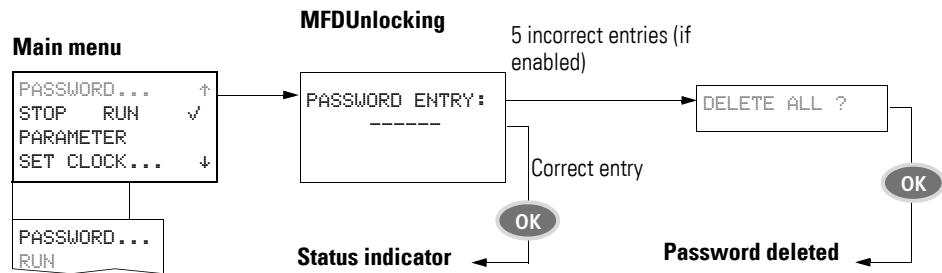

Figure 6: Entering the main or system menu

1.6.9.1 Unlocking MFD



1.6.10 System menu

► The System menu is accessed by simultaneously pressing DEL and ALT.

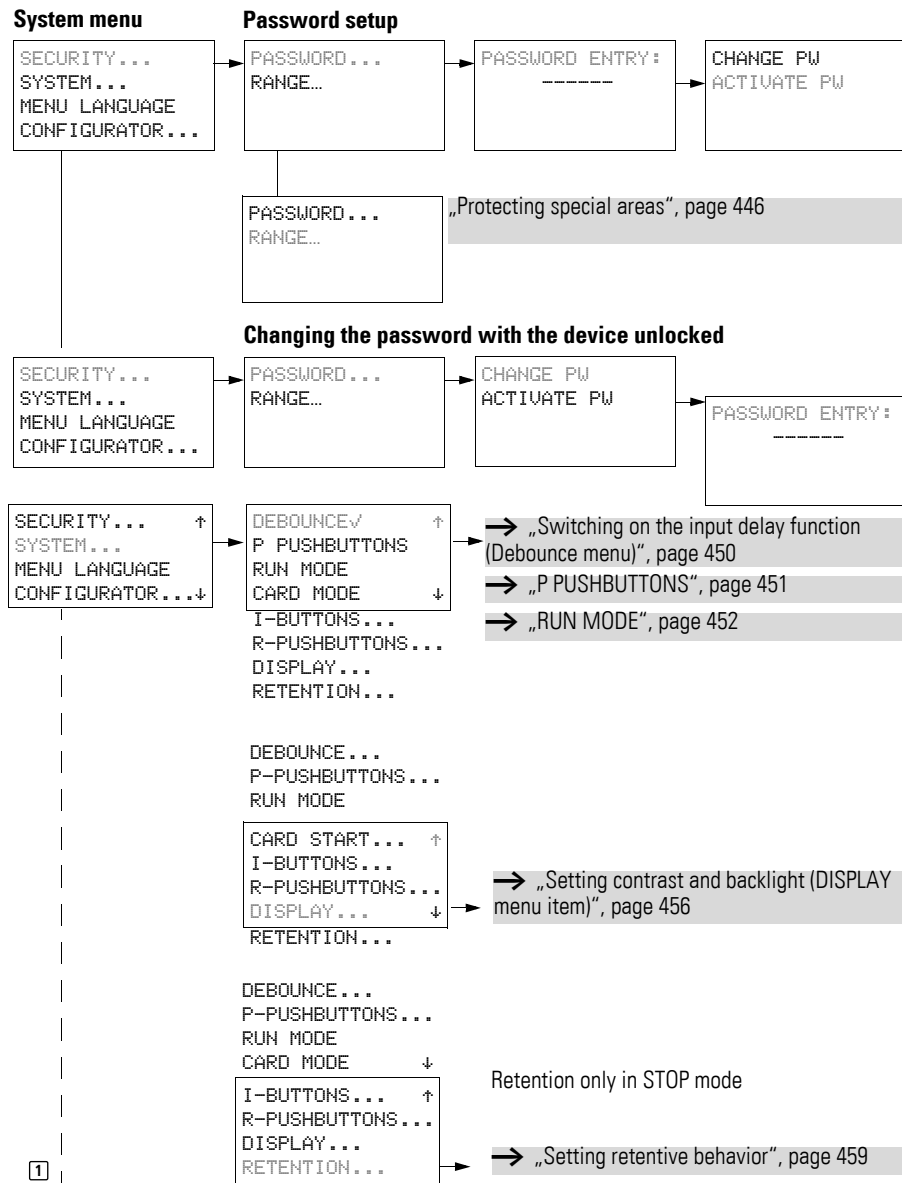

1 System menu

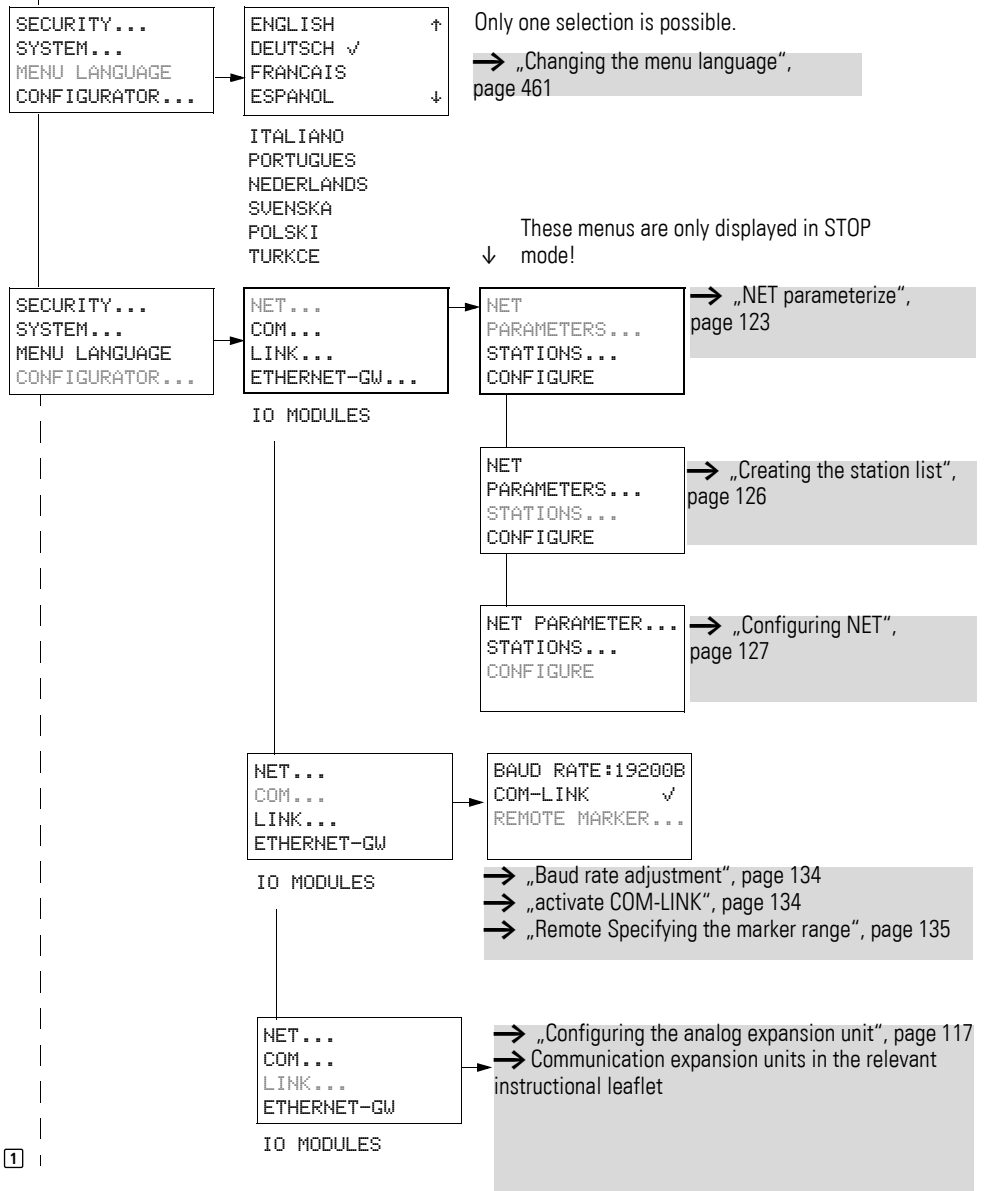

1 MFD

1.6 MFD operation

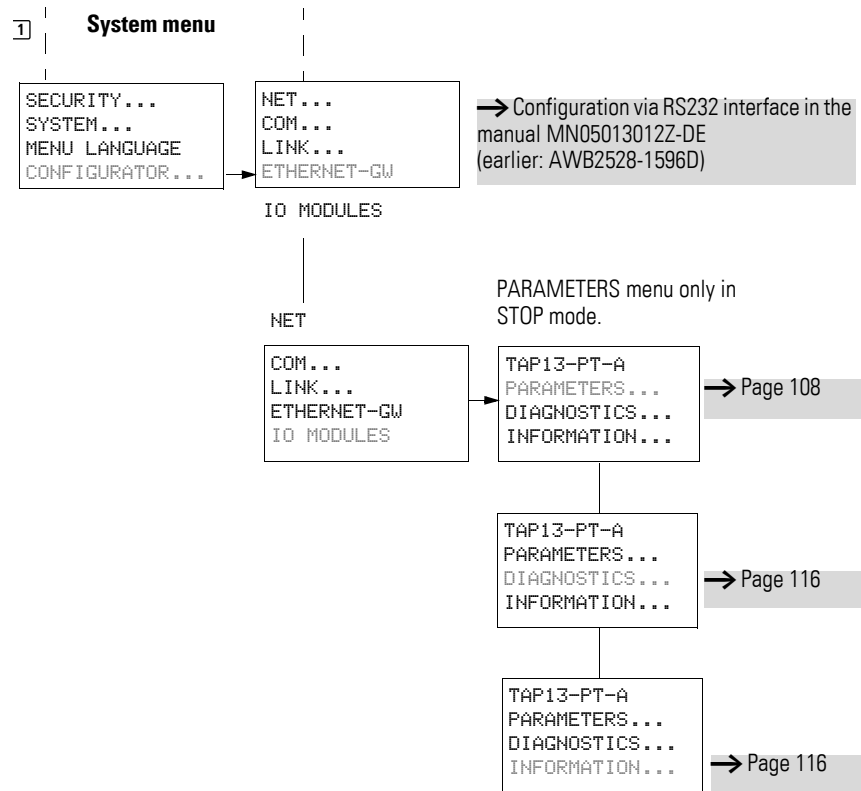

1.6.11 Selecting or toggling between menu items

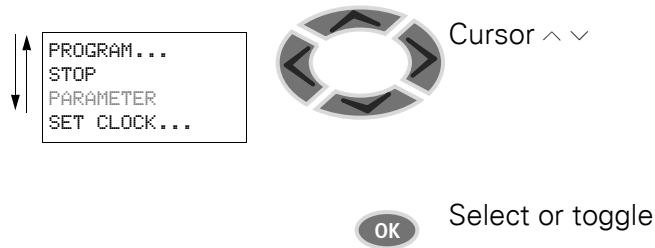

1.6.12 Cursor display

```

HH:MM █4:23
TT.MM  05.05
YEAR   2003
    
```

The cursor flashes.

Full cursor █:

- Move cursor with < >
- in circuit diagram also with ^ v

```

HH:MM 14:23
TT.MM  05.05
YEAR   2007
    
```

Value H/H

- Change position with <>
- Change values with ^ v

Flashing values/menus are shown in grey in this manual.

1.6.13 Setting values

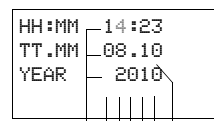

Values
Places
Value at

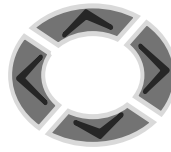

- Select value ^ v
- Select digit < >
- Change value at digit ^ v



Store settings



Retain previous value

1 MFD

1.6 MFD operation

2 Installation

MFD devices must only be installed and wired up by qualified electricians or other persons familiar with the mounting of electrical equipment.



DANGER OF ELECTRIC SHOCK!

Never carry out electrical work on the device while the power supply is switched on.

Always follow the safety rules:

- Switch off and isolate.
- Verify isolation from the supply.
- Secure against retriggering.
- Short-circuit and ground.
- Cover adjacent live parts.

The MFD devices are installed in the following order:

- "Mounting the MFD", page 40.
- "Mounting the expansion unit", page 54.
- "Connecting the power supply", page 57.
- "Connecting inputs", page 60.
- "Connecting outputs", page 75.
- "Connecting the easyNET network", page 82 (optional).
- "Connecting the serial multi-function interface", page 88 (optional).

2 Installation

2.1 Mounting the MFD

2.1 Mounting the MFD

Install the display/operating unit (MFD-80...) in the front of a control cabinet, a service distribution board, operator panel or in an enclosure. Install the power supply unit/CPU module (MFD-CP8.../CP10...) and the input/output module (I/O module) so that all the terminals are protected against direct contact, liquids and dust during operation.

When using the device without a display/operating unit, snap it onto a DIN EN 50022 top-hat rail or fix it in place using fixing brackets. The MFD can be mounted either vertically or horizontally.



When using the MFD device with expansion units, connect the expansion unit concerned before mounting (→ section "2.2 Mounting the expansion unit", page 54).

For ease of wiring, leave a gap of at least 3 cm between the device terminals and the wall or adjacent devices.

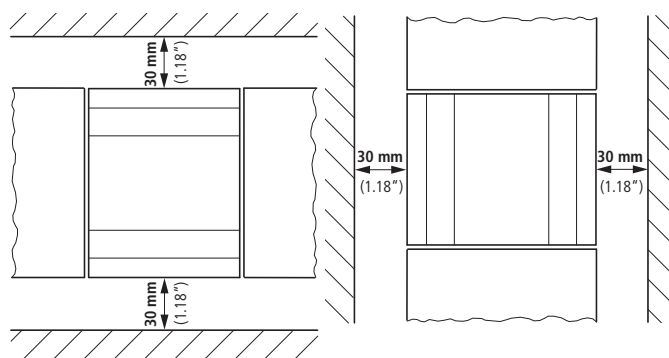

Figure 7: clearances to the MFD device.

Different installation steps must be carried out and sometimes in a different order, depending on the MFD combination you wish to use.

The following table provides an overview:

Table 6: Overview of mounting steps for the MFD device

		MFD-80	MFD-CP8/CP10	MFD-CP8/CP10 + I/O modules	MFD-CP8/CP10 + MFD-80	MFD-CP8/CP10 + MFD-80 + I/O modules
"Fitting the protective diaphragm"	→ Page 42	(x)			(x)	(x)
"Fitting the protective cover on the MFD-80"	→ Page 43	(x)			(x)	(x)
"Mounting the MFD-CP8/CP10 on a top-hat rail"	→ Page 50		x	x		
"Screwing on the MFD-CP8/CP10"	→ Page 53		x	x		
"Mounting the expansion unit"	→ Page 54				x	x
"Connecting the input/output module to the power supply unit/CPU module"	→ Page 48			x		x
Mounting the I/O expansion on a top-hat rail	→ Page 54		(x)	(x)	(x)	(x)
Screwing in the I/O expansion on the mounting plate	→ Page 54		(x)	(x)	(x)	(x)
Connecting the I/O expansion to MFD-CP8/CP10 (easyLink)			(x)	(x)	(x)	(x)
"Local expansion module"	→ Page 55		(x)	(x)	(x)	(x)
"Remote expansion"	→ Page 56		(x)	(x)	(x)	(x)

(x) = optional; MFD80 = display/HMI unit; MFD-CP8/CP10 = power supply/CPU module



In order to protect the MFD-80 with the protective diaphragm or protective cover, these must be fitted first of all, → Page 42 or page 43.

2 Installation

2.1 Mounting the MFD

2.1.1 Fitting the protective diaphragm/cover on the MFD-80

2.1.1.1 Fitting the protective diaphragm

For special applications such as in the food industry, the keypad must be protected against the ingress of dust, liquids etc.

For this use the specially designed protective diaphragm.

Fit the protective diaphragm before mounting the display/operating unit.

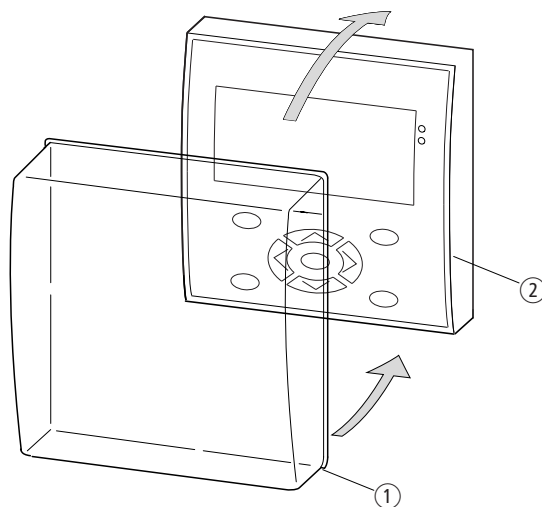

Figure 8: Fitting the protective diaphragm

- ① Protective diaphragm
- ② Display/keypad

- ▶ Fit the protective diaphragm over the display/operator unit.



DANGER

Ensure that the membrane fits snugly in the groove of the display/operator unit. Otherwise a proper seal cannot be guaranteed and particles may enter underneath the membrane. This may cause malfunctions in the keypad.

In food industry applications, there is the risk of bacteria building up underneath the membrane.

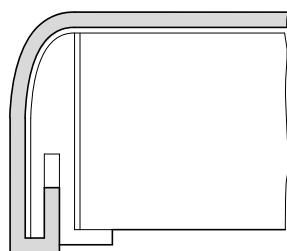

Figure 9: Correct location of the protective diaphragm

➔ If the protective diaphragm has to be replaced, the display/operating unit has to be removed. Replace the membrane and refit the device.

2.1.1.2 Fitting the protective cover on the MFD-80

The protective cover is provided for using the device in aggressive environments. This protects the display and the keypad against mechanical damage or destruction. Protection type to IP65 is maintained.

The protective cover can be opened so that the operating unit can be used.

The protective cover can be closed with a sealing facility to provide protection against unauthorized operation.

Before mounting the display/operating unit, fit the protective cover.

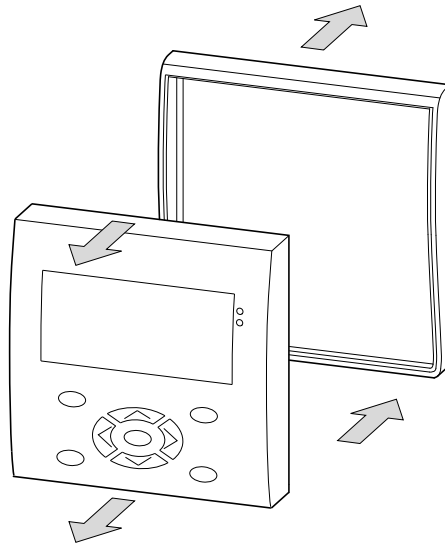

Figure 10: Removing the front frame

► Remove the front frame as shown in the figure.

The protective cover can be mounted in two different positions. Choose the position that is most suitable for the application at hand and your requirements.

2 Installation

2.1 Mounting the MFD

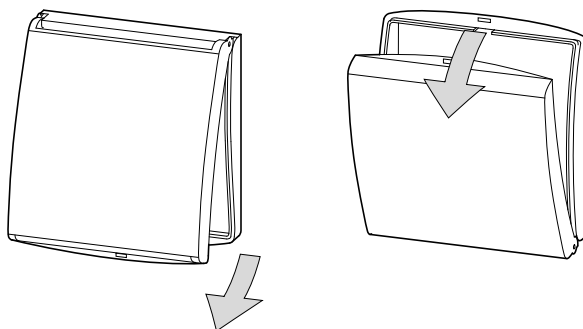

Figure 11: Position of the protective cover

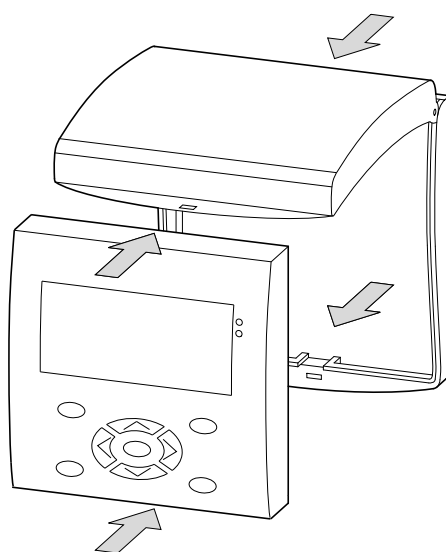

Figure 12: Mounting the protective cover

- ▶ Mount the protective cover as shown in the figure.

2.1.1.3 Sealing the protective cover

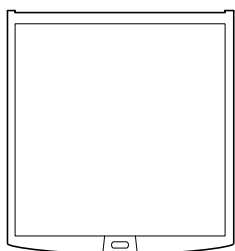

Figure 13: Sealing the protective cover

The grip handle of the protective cover is provided with holes that can be used in any mounting position. You can fit a wire or similar material through these holes in order to seal the cover. If the wire is provided with a lead seal, the cover is sealed. The cover can then only be opened by breaking the seal or the wire.

2.1.2 Front mounting of the MFD-80 display/HMI unit

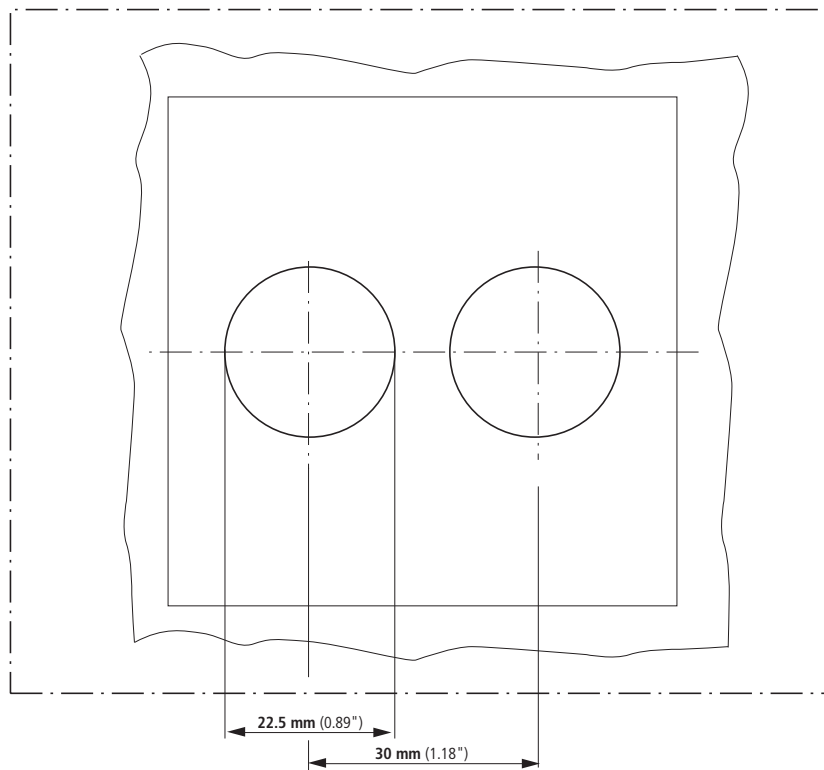

Figure 14: Drill holes for the MFD

- ▶ Drill and punch out two 22.5 mm diameter holes. The diameter is the same as is normally required for control circuit devices.

- ➔ Observe the following technical requirements:
 - The hole spacing is 30 mm.
 - The maximum thickness of the front plate for mounting the power supply/CPU module must not be more than 6 mm.
 - The maximum thickness of the front plate for mounting an expansion unit with a top-hat rail in addition to the power supply/CPU module must not be more than 4 mm.
 - Leave enough space at the side for the power supply unit/CPU module and, if necessary, the expansion unit.
 - In order to ensure protection type to IP65, the surface of the mounting front must be even and smooth.

2 Installation

2.1 Mounting the MFD

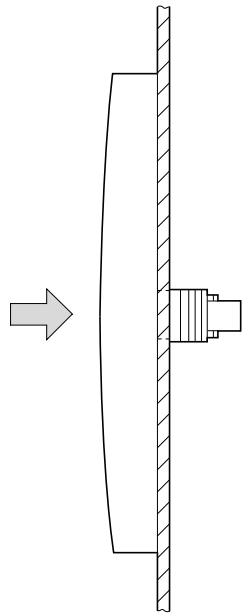

Figure 15: Mounting the display/operator unit

- ▶ Fit the display/operator unit in the punched fixing holes.

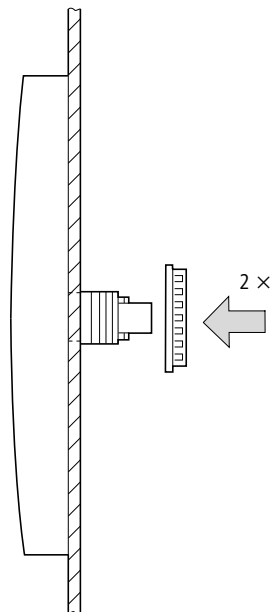

Figure 16: Screw fastening the display/operating unit

- ▶ Screw fasten the display/operating unit.

The tightening torque must be between 1.2 and 2 Nm.



Ensure that the correct torque is used. If the tightening torque is too low or high, this may impair the seal.

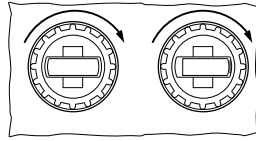

Figure 17: Rear of the mounted display/operator unit

Use the mounting ring tool with the designation M22-MS.

2.1.2.1 Removing the display/operating unit

- ▶ Unscrew the fixing element and remove the display/operator unit.

2.1.3 Connecting the power supply/CPU to the display/HMI unit



If you wish to run the MFD device with an expansion unit, you must fit the top-hat rail on the power supply unit/CPU module before connecting the display/operating unit, → section "2.1.5.2 Use with display/HMI unit and expansion units", page 52.

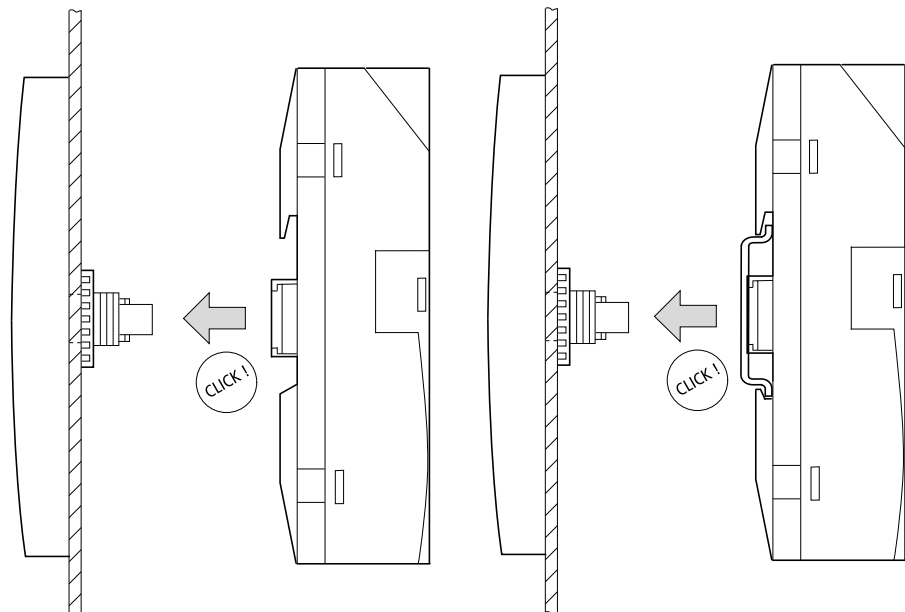

Figure 18: Connecting the power supply/CPU to the display/HMI unit: left without, right with the top-hat rail

2 Installation

2.1 Mounting the MFD

2.1.4 Connecting the input/output module to the power supply unit/CPU module

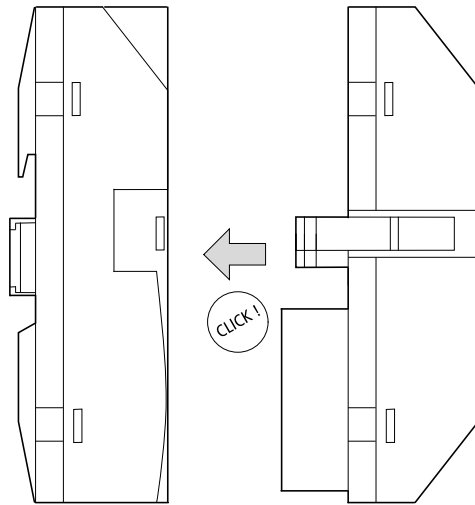

Figure 19: Fitting the input/output module



You can connect the power supply unit/CPU module to the input output module (I/O module) and/or display/operating unit in any order.

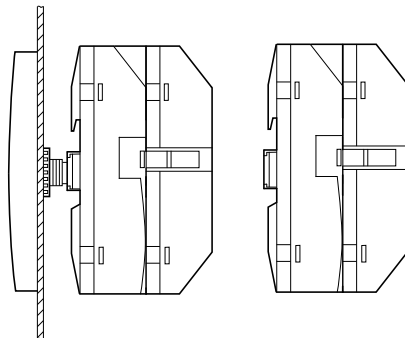

Figure 20: Power supply unit/CPU module with input/output module, left with, right without display/operating unit

2.1.4.1 Removing the input/output module

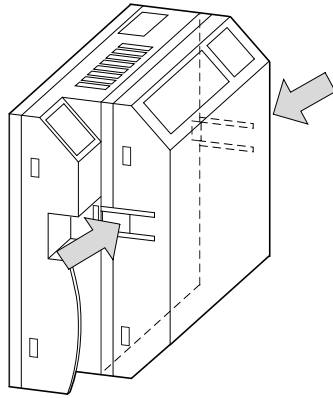

Figure 21: Releasing the input/output module

- ▶ Press the two catches together.
- ▶ Pull one side out of the catch.
- ▶ Pull the other side out of the second catch.

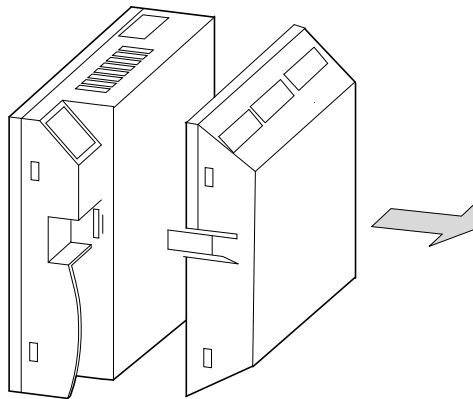

Figure 22: Removing the input/output module

- ▶ Detach the input/output module.

2 Installation

2.1 Mounting the MFD

2.1.4.2 Removing the power supply/CPU module

The power supply unit/CPU module can be removed with or without the output module.



Undo any additional fixings on the top-hat rail.

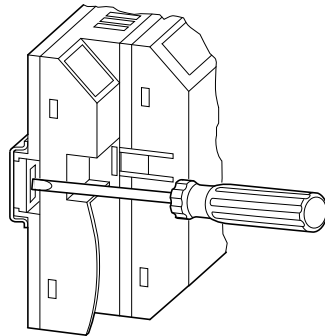

Figure 23: Releasing the fixing shaft

Use a screwdriver with a 100 x 3.5 mm slot width.

- ▶ Insert the screwdriver into the strap of the fixing shaft catch.
- ▶ Lever out the slide catch.
- ▶ Pull out the power supply/CPU module from the fixing shafts.

2.1.5 Mounting the MFD-CP8/CP10 on a top-hat rail

If you wish to run the power supply/CPU module without a display/HMI unit or with an expansion unit, you can fit it to a top-hat rail.

Alternatively you can also use the screw mounting, → section "2.1.6 Screwing on the MFD-CP8/CP10", page 53

2.1.5.1 Use without display/HMI unit

The fastening catches must be removed in order to mount the device on a fastened top-hat rail.

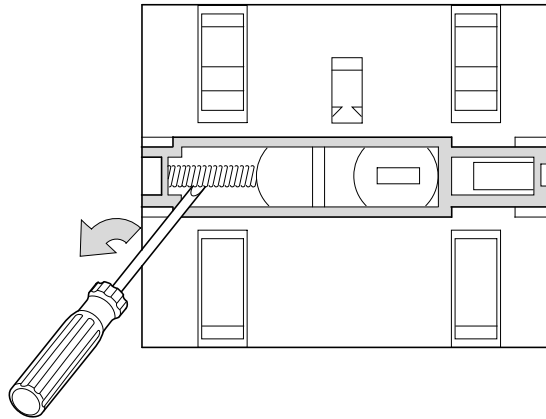

Figure 24: Removing the spring

- ▶ Remove the spring with a screwdriver.

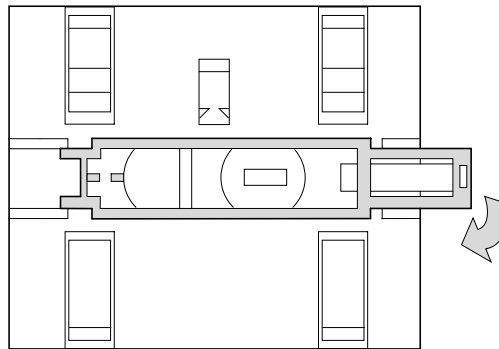

Figure 25: Pulling the slide catch and removing

- ▶ Pull the slide catch out of the guide and remove it.

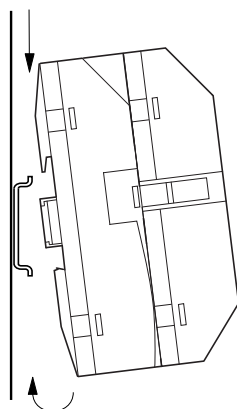

Figure 26: Snap fitting the device to the top-hat rail

- ▶ Place the MFD device diagonally on the upper lip of the top-hat rail. Press down lightly on both the device and the top-hat rail until the unit snaps over the lower edge of the top-hat rail.

The MFD device will clip into place automatically.

2 Installation

2.1 Mounting the MFD

- ▶ Check that the device is seated firmly.

The device is mounted vertically on a top-hat rail in the same way.

2.1.5.2 Use with display/HMI unit and expansion units

Ensure that the cutout of the top-hat rail was prepared for the fixing shafts according to the specified dimensions.

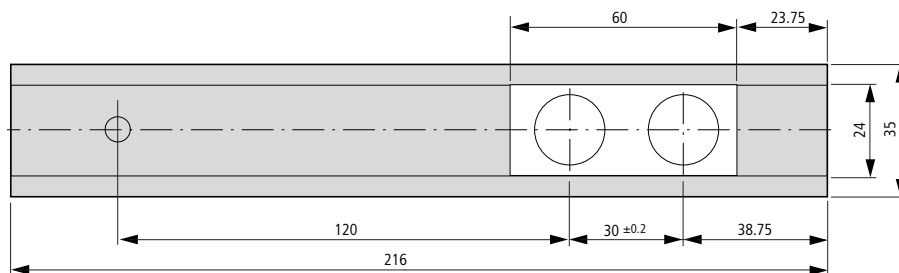

Figure 27: Top-hat rail with cutout



The two fixing shafts of the display/operating unit are designed for a 2 space unit expansion unit.

If you wish to fit wider expansion units, the top-hat rail must be supported at a third support point. This third support point should be located in the area 216 mm from the end of the device. It should not be possible to twist the top-hat rail.



DANGER

The fixing shafts of the display/operating unit are designed for mounting the expansion units. Other devices such as contactors must not be mounted on this top-hat rail.

Attach the expansion unit before fitting the top-hat rail.

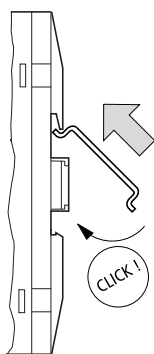

Figure 28: Fitting the top-hat rail

- ▶ Fit the top-hat rail in the groove using the slide catch of the power supply/CPU module and the expansion unit.
- ▶ Turn the top-hat rail towards the housing.
- ▶ Let the top-hat rail snap into position.
- ▶ Press the power supply/CPU module onto the fixing shaft.

2.1.6 Screwing on the MFD-CP8/CP10

You can also screw the power supply/CPU module onto a mounting plate, for example, if you wish to use it without a display/HMI unit or with an expansion unit.

Alternatively, you can mount the device on a top-hat rail, → section "2.1.5 Mounting the MFD-CP8/CP10 on a top-hat rail", page 50.

Fixing brackets that can be inserted on the rear of the MFD device are required for screw mounting. The fixing brackets are available as an accessory.

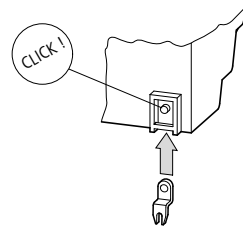

Figure 29: Inserting a fastening bracket



Three fixing brackets are sufficient for a device with four fixing points.

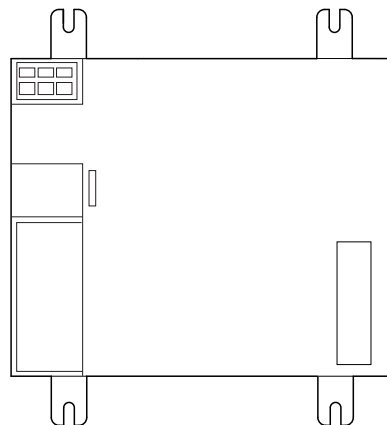

Figure 30: Screw mounting MFD

2 Installation

2.2 Mounting the expansion unit

2.2 Mounting the expansion unit

To increase the number of inputs/outputs, you can connect expansion units via the easyLink connection of the MFD basic devices.

Fit the expansion units in exactly the same way as a basic device on the top-hat rail or by screwing on fixing brackets.

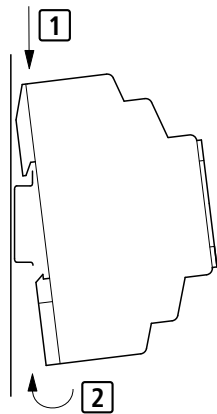

Figure 31: Top-hat rail mounting

EASY2... EASY4... EASY6...

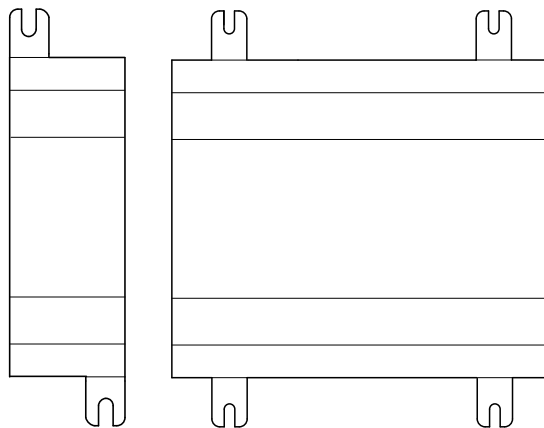

Figure 32: Screw mounting

Locally and remotely connected expansion units have a different connection.

Local expansion units are connected directly next to the MFD power supply/CPU module with easyLink.

With remote expansion, the expansion unit is connected via a two-wire or multi-core cable up to 30 m in length to the EASY200-EASY coupling device, which is connected directly to the basic device via the easyLink terminal.

2.2.1 Local expansion module

- ▶ Connect the easy expansion unit via the EASY-LINK-DS bus connector plug.

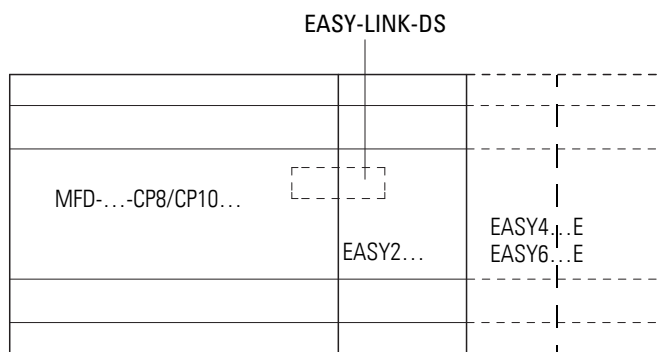

Figure 33: Connecting local expansion with basic device



DANGER

The following electrical isolation is implemented between the MFD power supply/CPU module and the expansion unit (isolation always in local connection of expansion unit):

- Basic isolation 400 V AC (+10 %).
- Safe isolation 240 V AC (+10 %).

Units may be destroyed if the value 400 V AC +10 % is exceeded, and may cause the malfunction of the entire system or machine!



Power supply unit/CPU modules and expansion units can be fed by different DC power supplies.

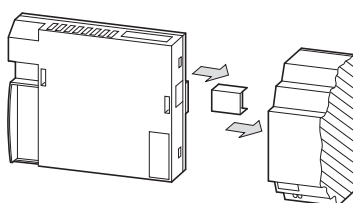

Figure 34: Mounting local expansion module on MFD-CP8.../CP10...

Specific system information is shown in the status display of the basic device (e.g. DC, AC or GW) depending on the expansion unit that is connected and operational.

2 Installation

2.2 Mounting the expansion unit

2.2.2 Remote expansion

With remote expansion module, you connect the expansion unit via a connecting cable to the EASY200-EASY coupling unit, which itself is fitted on the basic device via the easyLink terminal. The connecting cable can be up to 30 m in length.

! DANGER

The two-wire or multiple-wire cable between the devices must adhere to the insulation voltage requirement which is stipulated for the installation environment. Otherwise, a fault scenario (ground fault, short-circuit) may lead to the destruction of the units or injury to persons.

A cable, such as NYM-0 with a rated operational voltage $U_e = 300/500 \text{ V AC}$, is normally sufficient.

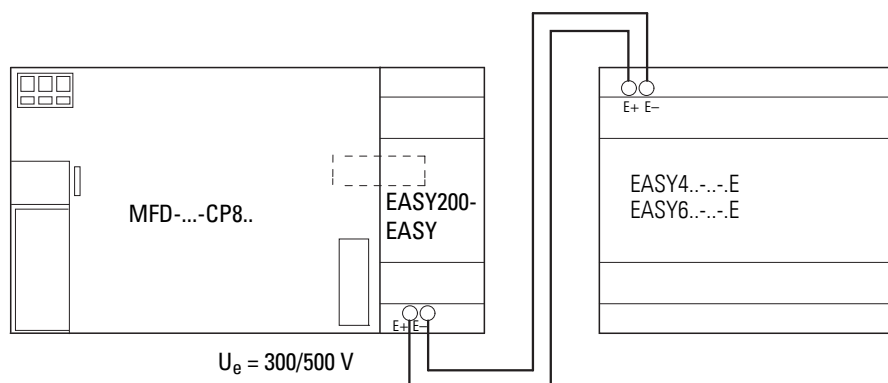

Figure 35: Connecting remote expansion



Terminals E+ and E- of the EASY200-EASY are protected against short-circuits and polarity reversal. Functionality is only ensured if E+ is connected with E+ and E- with E-.

2.3 Terminations

2.3.1 Tools

Flat blade screwdriver, blade width 3.5 x 0.6 mm, for use on the spring-cage terminal.

2.3.2 Cable cross-sections

- Solid: 0.2 to 4 mm² (AWG 22 -12).
- Flexible with ferrule: 0.2 to 2.5 mm².

How to connect the easyNet network → section "2.7 Connecting the easyNET network", page 82.

2.4 Connecting the power supply

2.4.1 Cable protection

With the AC and DC variant of the power supply unit/CPU module and with the expansion unit connect cable protection (F1) of at least 1 A (slow).

CAUTION

When the basic devices and expansion units are switched on, they behave like a capacitor, so that an inrush current higher than the rated input current is present. Take this inrush current into account when designing the electrical equipment by using slow fuses and suitable switches. Never use reed relay contacts to switch the supply voltage as these may burn or stick. When designing the DC power supply unit, bear the inrush current in mind and use time-lag fuses.



The relevant connection data for the different device types → Chapter "MFD-80.. display/operator unit", page 495. The devices run a system test for one second after the supply voltage has been switched on. After this time the device switches to RUN or STOP operating mode depending on the default setting.



DANGER

Ensure that the L and N conductor are not reversed.

2 Installation

2.4 Connecting the power supply

2.4.2 MFD-AC... power supply unit/CPU module

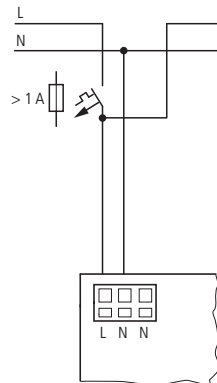

Figure 36: Power supply on the MFD, AC variant

2.4.3 AC expansion unit EASY618-AC-RE

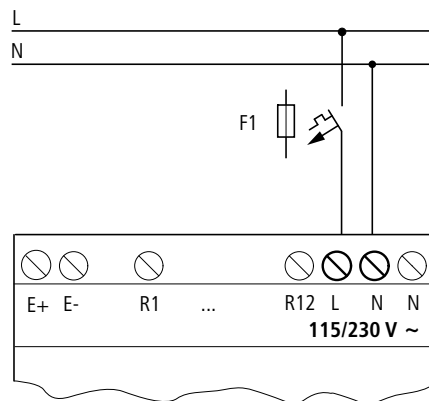

Figure 37: Power supply on the AC expansion unit

2.4.4 MFD-... DC power supply/CPU module

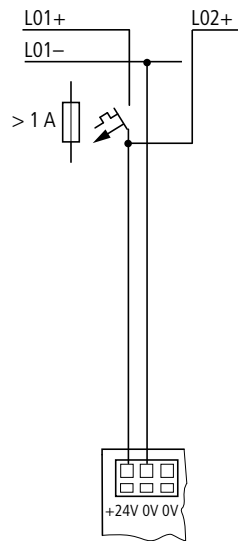

Figure 38: Power supply on the MFD, DC variant

The power supply/CPU module supplies the display/HMI unit, the input/output electronics as well as the optional easyNet network with the necessary power supply.



DC basic devices and expansion units are protected against reverse polarity. However, you must ensure the correct polarity so that the devices function reliably and safely.

2.4.5 DC expansion unit EASY...-DC-.E

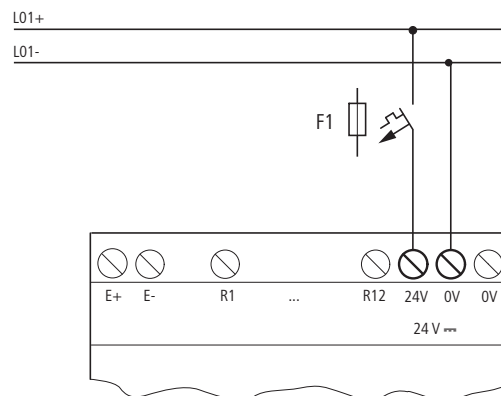

Figure 39: Power supply on the DC expansion unit

2.5 Connecting inputs

The inputs of the MFD devices switch electronically. Once you have connected a contact via an input terminal, you can reuse it as a contact in your circuit diagram as often as you like.

Connect the contacts, for example pushbuttons or switches, to the input terminals of the MFD device.

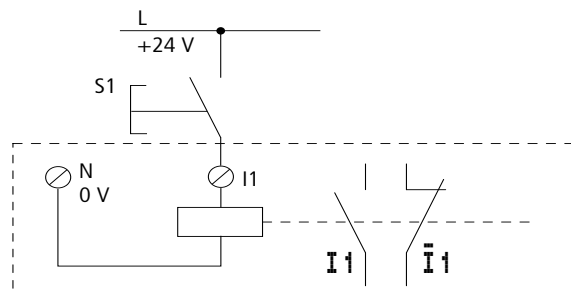

Figure 40: Connecting input, in this case I 1.

See also:

- "Connect digital AC inputs", page 61.
- "Connecting easy DC digital inputs", page 65.
- "Connecting analog inputs", page 69.

When using special function blocks, certain inputs are permanently assigned to these function blocks and cannot be used for any other purpose. The relevant function block description describes which inputs are affected.

Example: With the "high-speed counter" function block, the device inputs I1 - I4 are connected directly on one function block.

You can increase the number of inputs of the MFD device (basic device) by using an expansion unit. The inputs of the EASY4..-DC-.E and EASY6..-DC-.E digital expansion units are detected by the basic device automatically - without any configuration.

See also:

- "Connect digital AC inputs", page 62.
- "Connecting easy DC digital inputs", page 68.

The universal EASY4..-DC-.ME expansion units allow you to process both digital and analog values. The digital inputs of these expansion units are detected by the basic device automatically - without any configuration. The analog inputs/outputs must normally be configured.

See also:

- "Connect digital AC inputs", page 62.
- "Connecting easy DC digital inputs", page 68.
- "Connecting analog inputs", page 73.

2.5.1 Connect digital AC inputs



DANGER

Connect the inputs for AC basic and expansion units in accordance with the safety regulations of VDE, IEC, UL and CSA with the same phase conductor that provides the power supply voltage. The device will otherwise not detect the switching level or may be destroyed by overvoltage.

Connect the inputs for AC basic and expansion units in accordance with the safety regulations of VDE, IEC, UL and CSA with the same phase conductor that provides the power supply voltage. The device will otherwise not detect the switching level or may be destroyed by overvoltage.

2.5.1.1 Connecting AC inputs of the basic device MFD-AC-R16

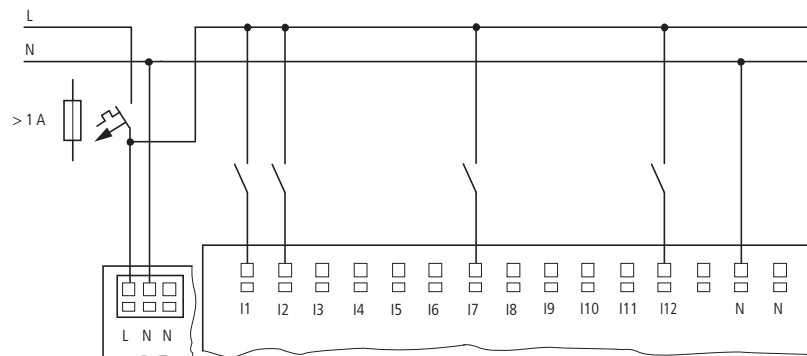

Figure 41: Connecting inputs on the AC basic device MFD-AC-R16



DANGER

The AC inputs must only be used together with the MFD-AC-CP8-.. power supply/CPU modules. Other power supply/CPU modules may be destroyed.

- Input signal voltage range
 - Off signal: 0 to 40 V.
 - On signal: 79 to 264 V
- Input current
 - I1 to I12: 0.5 mA/0.25 mA at 230 V/115 V.

2 Installation

2.5 Connecting inputs

2.5.1.2 Connecting AC inputs of the expansion unit EASY618-AC-RE

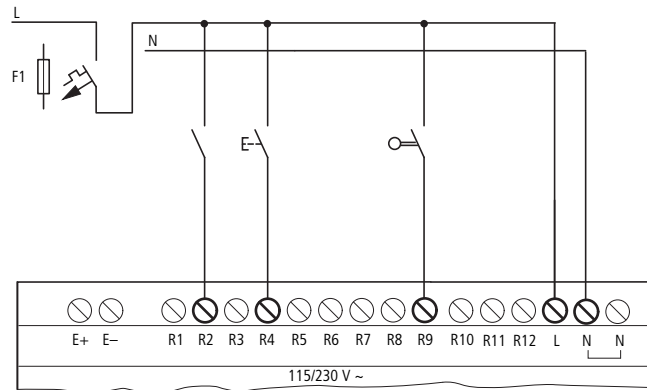

Figure 42: Connecting inputs on the easy618-AC-RE AC expansion unit

Connect the inputs, for example, to pushbutton actuators, switches or relay/contactors contacts.

- Input signal voltage range
 - Off signal: 0 to 40 V.
 - On signal: 79 to 264 V
- Input current
 - R1...R12: 0.5 mA/0.25 mA at 230 V/115 V.

Length of input cables

Severe interference can cause a signal 1 on the inputs without a proper signal being applied. Observe therefore the following maximum cable lengths:

- I1 to I12 and R1 to R12: 40 m without additional circuit

The following also applies to the expansion units:

With longer cables connect a diode (e.g. 1N4007) with a minimum reverse voltage of 1 kV and a forward current of 1 A in series to the device input. Ensure that the diode is pointing to the input as shown in the circuit diagram; otherwise the device will not be able to detect the 1 state.

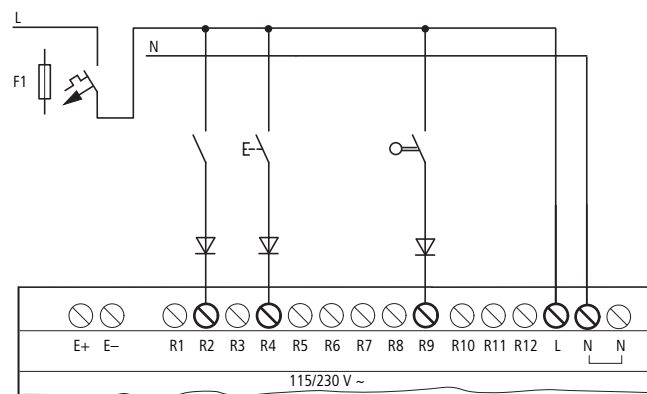

Figure 43: Connecting inputs on the EASY618-AC-RE AC expansion unit via diodes

Two-wire proximity switches have a residual current in the 0 state. If this residual current is too high, the device only detects the 1 state at the input.

Use an additional input circuit if several inputs are required with a higher input current.

Increased input current

The following input circuit can be used in order to prevent interference and also when using two-wire proximity switches:

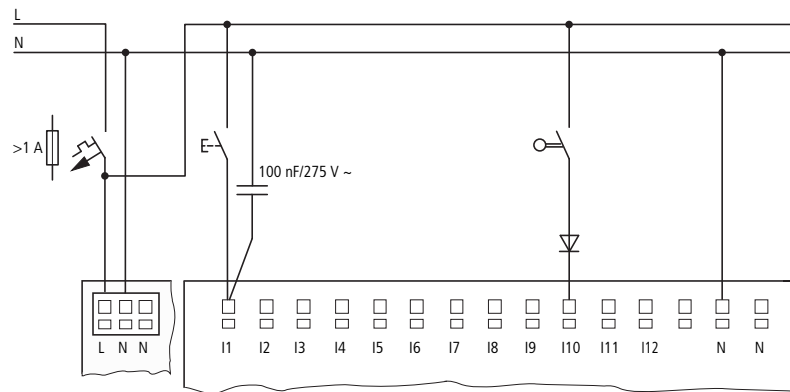

Figure 44: Increasing the input current at the AC basic device

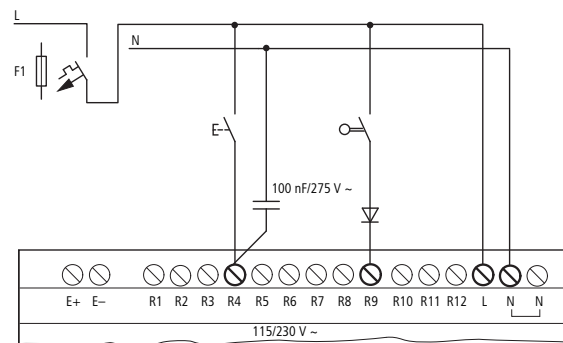

Figure 45: Increasing the input current at the AC expansion unit EASY618-AC-RE



When using a 100 nF capacitor, the drop-out time of the input increases by 80 (66.6) ms at 50 (60) Hz.

A resistor can be connected in series with the circuit shown in order to restrict the inrush current.

2 Installation

2.5 Connecting inputs

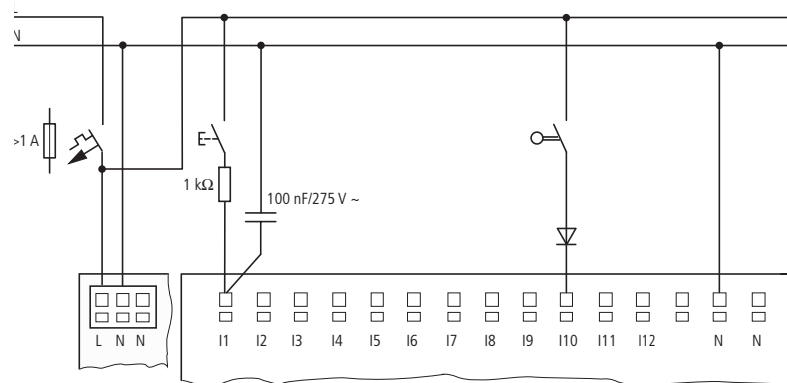

Figure 46: Limitation of the input current with a resistor at the AC basic device

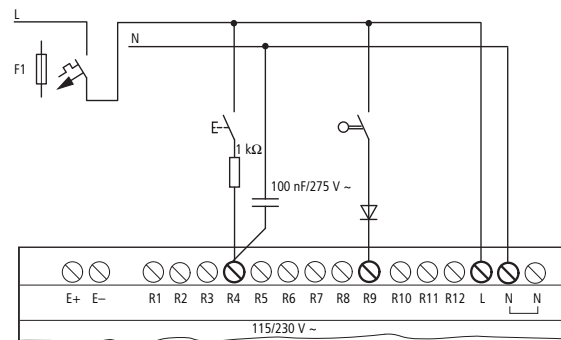

Figure 47: Limitation of the input current with a resistor at the AC expansion unit EASY618-AC-RE

Complete devices for increasing the input current are available under the part no. EASY256-HCI.

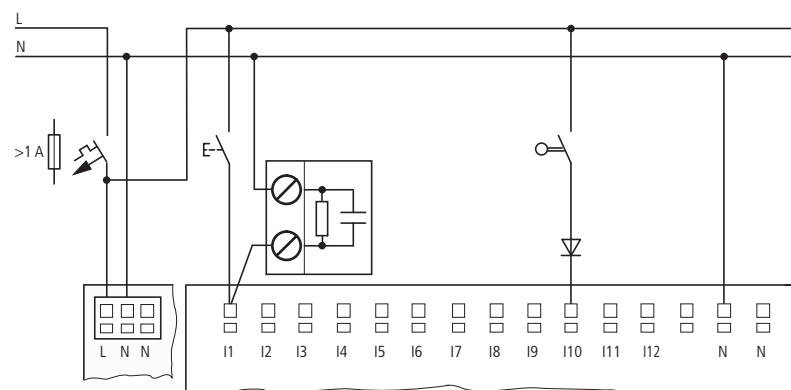

Figure 48: AC basic device with EASY256-HCI to increase the input current

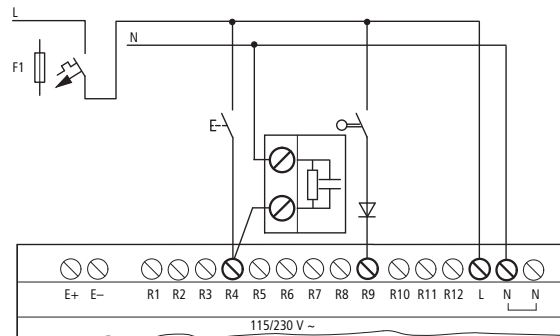

Figure 49: AC expansion unit with EASY618-AC-RE with EASY256-HCI to increase the input current



The increased capacitance increases the drop-off time by approx. 40 ms.

2.5.2 Connecting easy DC digital inputs

2.5.2.1 Connecting DC inputs of the basic devices MFD-R.16(17) and MFD-T.16(17)

Connect pushbutton actuators, switches, 3 or 4-wire proximity switches to input terminals I1 to I12 of the DC basic device (standard I/O module). Given the high residual current, do not use 2-wire proximity switches.

These DC basic devices enable you to read both digital and analog input signals via the inputs I7 (IA01), I8 (IA02), I11 (IA03) and I12 (IA04).

- Digital input signal voltage range
 - I1 to I6, I9, I10.
Signal OFF: 0 to 5 V.
Signal ON: 15 to 28.8 V.
 - I7, I8, I11, I12.
Signal OFF: < 8 V.
Signal ON: > 8 V.
- Input current:
 - I1 to I6, I9, I10, R1 to R12: 3.3 mA at 24 V
 - I7, I8, I11, I12: 2.2 mA at 24 V



Feed the digital inputs from the same 24 V DC power source as the device.

2 Installation

2.5 Connecting inputs

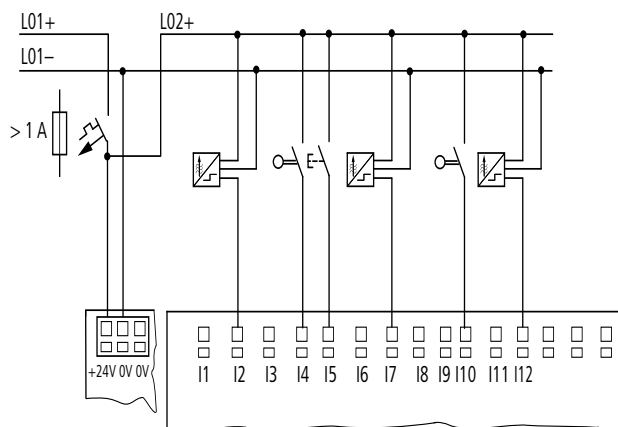

Figure 50: Example application with DC basic device MFD-R.16(17) and MFD-T.16(17)

2.5.2.2 Connecting DC inputs of the basic devices MFD-TP.../MFD-TAP...

The MFD-TP.../MFD-TAP... I/O modules (I/O modules with temperature measuring) are provided with four digital DC inputs (terminal I1 - I4). In addition to this, you can also use the analog inputs I11 (IA03) and I12 (IA04), which are provided for 0 V - 10 V analog value measuring, for use with digital input signals (→ section "2.5.3.2 Connecting analog and temperature inputs of MFD-TP.../MFD-TAP...", page 72).

- Digital input signal voltage range
 - I1 to I4
Signal OFF: -30 to 5 V.
Signal ON: 15 to 28.8 V.
 - I11, I12
Signal OFF: < 8 V.
Signal ON: > 8 V.
- Input current:
 - I1 to I4: 3.3 mA at 24 V.
 - I11, I12: 2.2 mA at 24 V.



Feed the digital inputs from the same 24 V DC power source as the device.

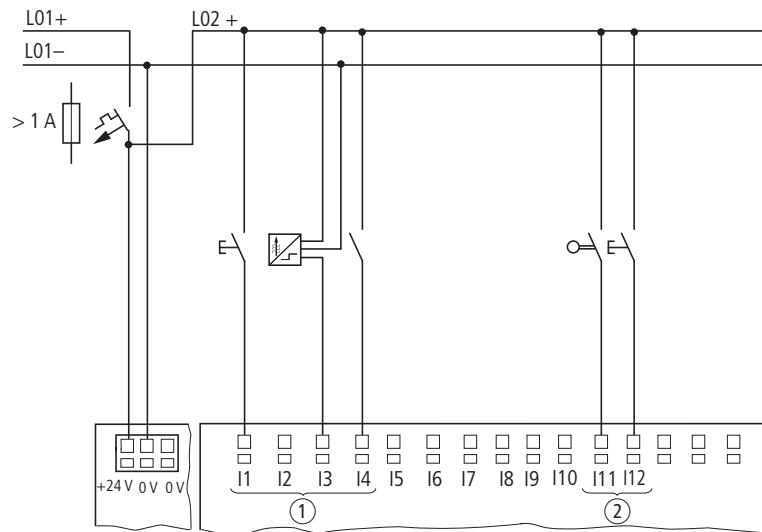

Figure 51: Example application with DC basic device MFD-TP.../MFD-TAP..., processing of digital input signals

- ① DC inputs (terminal I1 - I4).
- ② Analog inputs 0 V - 10 V (terminal I11, I12).

Connecting high-speed counters and frequency generators

The digital inputs I1 - I4 of the standard I/O module and I/O module with temperature measuring allow you to accurately measure high-speed counter signals or frequencies and bypass the cycle time.

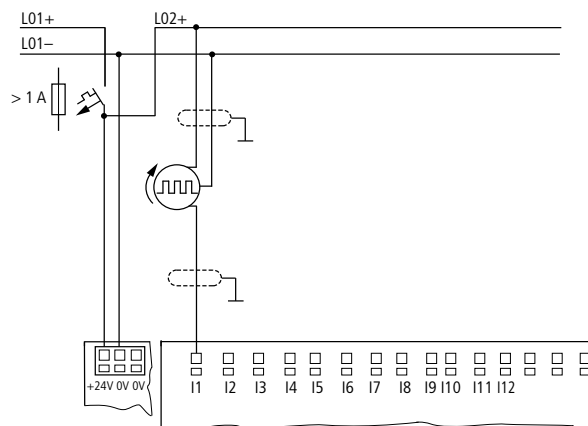

Figure 52: High-speed counter, frequency encoder on standard I/O module

2 Installation

2.5 Connecting inputs

Connecting incremental encoders

The standard I/O module and I/O module with temperature measuring allow you to connect one incremental encoder each to the digital inputs I1, I2, I3 and I4.

This enables you to count high-speed incremental values independently of the cycle time. The incremental encoder must output two 24 V DC square wave signals with a phase offset.

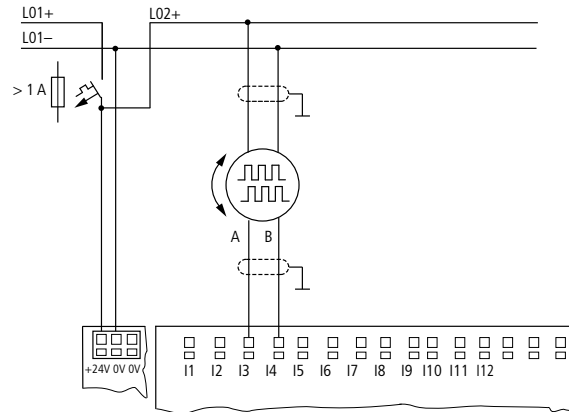

Figure 53: Connecting incremental encoders

2.5.2.3 Connecting DC inputs of the expansion units EASY410... and EASY6...

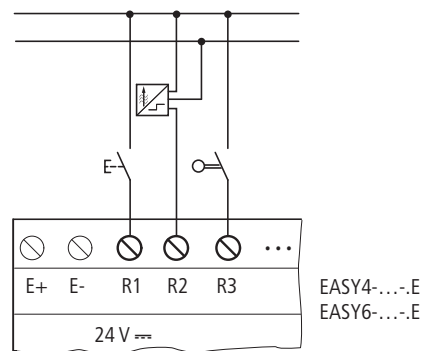

Figure 54: EASY410-C-E and EASY6..-DC-E (digital expansion unit)

Connect the inputs, for example, to pushbutton actuators, switches or relay/contactactor contacts.

- Input signal voltage range
 - R1 to R6 (EASY410...), or R1 to R12 (EASY6...)
Signal OFF: 0 to 5 V.
Signal ON: 15 to 28.8 V.
- Input current
 - R1...R6 or R12: 3.3 mA at 24 V

2.5.2.4 Connecting DC inputs of the EASY4..-DC-ME expansion units

In addition to the analog inputs/outputs, the EASY4..-DC-ME DC expansion units are provided with the digital input R1. In addition to R1 you can also always use the analog 0 V - 10 V voltage inputs R2/R3 (terminals 2 and 7) as additional digital inputs and actuate them with up to 24 V DC.

Both expansion devices show a 0 signal at R2/R3 if the voltage goes below 8 V DC and a 1 signal if the voltage exceeds this value.

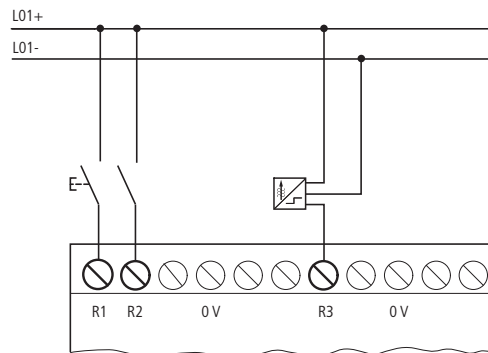

Figure 55: Digital inputs of the EASY4..-DC-ME



R2/R3 can always be used as additional digital inputs, even if they have not been expressly configured in the programming software as analog voltage inputs. Current and temperature inputs cannot be used as digital inputs.

Further information on the voltage range and input current of the input signals → section "2.5.2 Connecting easy DC digital inputs", page 65.

2.5.3 Connecting analog inputs

All power supply/CPU modules with a 24V DC power supply can be fitted with a standard I/O module or an I/O module with temperature measuring, which each have digital and analog inputs.

On the MFD, it is also possible to connect the EASY406-DC-ME and EASY411-DC-ME DC expansion unit (→ section "2.5.2.4 Connecting DC inputs of the EASY4..-DC-ME expansion units", page 69).

2 Installation

2.5 Connecting inputs



DANGER

Analog signals are more susceptible to interference than digital signals, so that the signal cables must be laid and connected more carefully. The measures described below must be adhered to in order to prevent any deviations in analog values. An incorrect connection can lead to unwanted switching states.

- ▶ Use shielded or twisted pair cables.
- ▶ Keep signal cables as short as possible and not longer than 10 m.
- ▶ With short cable lengths ground the shield of the signal cables at both ends with a large surface area connection. With longer signal cables, the shield should only be grounded at one end, on the side of the MFD or expansion unit. Otherwise compensation currents between both grounding points may flow, leading to the interference of analog signals.
- ▶ Lay signal cables separately from heavy current cables.
- ▶ Connect inductive loads to be switched via the MFD device outputs to a separate power feed, or use a suppressor circuit for motors and valves. If loads such as motors, solenoid valves or contactors and MFD are operated with the same power feed, switching may give rise to interference on the analog input signals.
- ▶ Ensure a galvanic connection of the reference potential as described below.
- ▶ Avoid the operation of the MFD or expansion unit on an ungrounded power supply.

2.5.3.1 Connecting analog inputs of the basic device

You can read analog voltages in the range 0 to 10 V via the inputs I7, I8, I11 and I12 of the DC basic device MFD-R.16(17) and MFD-T.16(17).

The signal has a 10-bit resolution, value range 0 - 1023.

The following therefore applies:

- I7 = IA01
- I8 = IA02
- I11 = IA03
- I12 = IA04

The analog voltage inputs can also be used as digital inputs.



You can also use an MFD-TP.../MFD-TAP... DC basic unit (I/O modules with temperature measuring) for analog value measuring (→ section "2.5.3.2 Connecting analog and temperature inputs of MFD-TP.../MFD-TAP...", page 72).

The following circuits are examples of using the analog value measuring via inputs of the DC basic device.

➔ Ensure that the reference potential is galvanically connected. Connect the 0 V of the power supply unit for the different setpoint potentiometers and sensors shown in the examples to the 0 V terminal of the MFD power supply.

Setpoint potentiometer

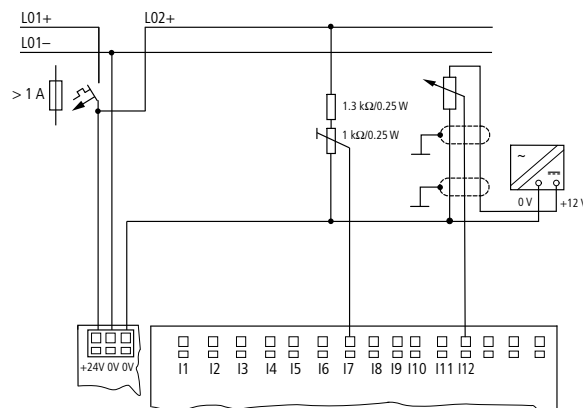

Figure 56: Setpoint potentiometer with upstream resistor

Use a potentiometer with the resistance $\leq 1 \text{ k}\Omega$ e.g. $1 \text{ k}\Omega$, 0.25 W .

Temperature , brightness and 20 mA sensor

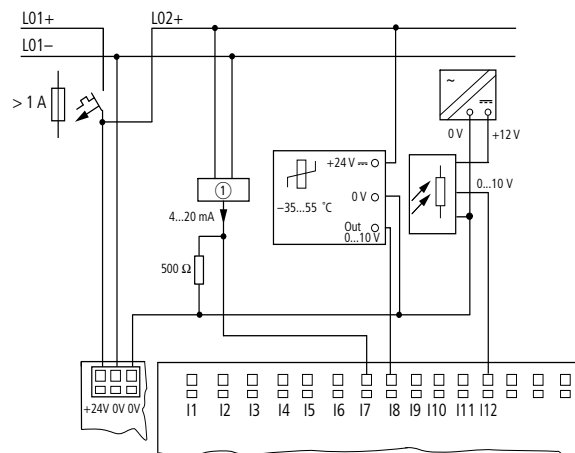

Figure 57: MFD-R.16(17) and MFD-T.16(17) with temperature, brightness and 20 mA sensor
① Analog sensor

A 4 to 20 mA (0 to 20 mA) sensor can be connected on the voltage input using an external 500Ω resistor (twice $1 \text{ k}\Omega$ in parallel).

2 Installation

2.5 Connecting inputs

The following values apply:

- 4 mA = 2.0 V
- 10 mA = 5.0 V
- 20 mA = 10.0 V

(according to $U = R \times I = 500 \Omega \times 10 \text{ mA} = 5.0 \text{ V}$)

2.5.3.2 Connecting analog and temperature inputs of MFD-TP.../MFD-TAP...

You can use an MFD-TP... or MFD-TAP... DC basic unit to connect PT100 and NI1000 temperature sensors directly to the MFD and also measure voltages. The temperatures are measured with a 12-bit resolution (0 - 4095) and can be set to different measuring ranges between -200 °C and 850 °C.

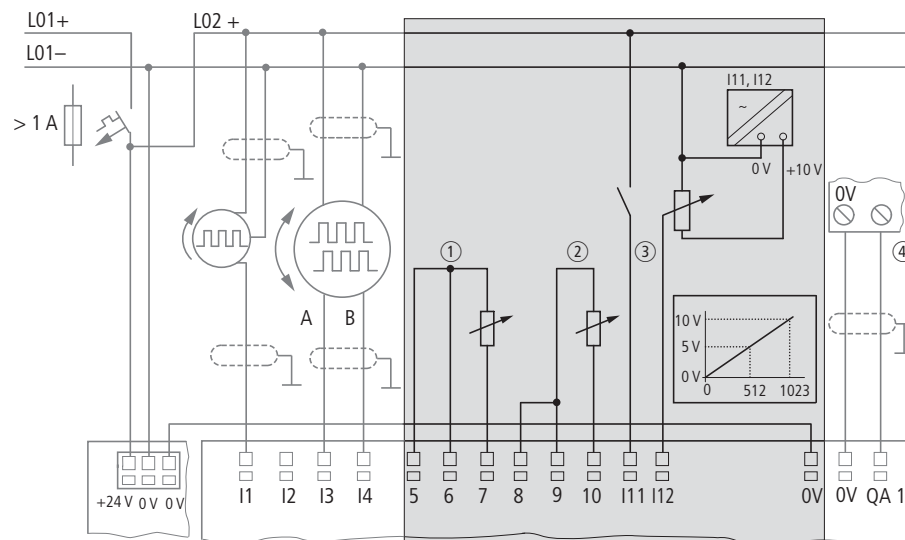

Figure 58: Connecting the analog and temperature inputs on the MFD-TP.../MFD-TAP...

- ① Temperature input (example three-wire connection).
- ② Temperature input (example two-wire connection).
- ③ Analog IN, I11=IA03, I12=IA04.
- ④ Analog OUT, QA01 (only MFD-TAP13-...).

The temperature sensors can be connected directly to the three terminals of inputs IA01 (terminal I5 - I7) and IA02 (terminal I8 - I10). A three-wire connection or a two-wire connection is possible, → Figure 58, page 72. On terminals I5 and I8, the temperature module outputs a constant current to the temperature sensor.

With three-wire measuring, the line resistance is compensated by means of a measuring bridge in the temperature module.

With two-wire connections, connect a short-circuit bridge between terminals I5 and I6 or I8 and I9.



DANGER

Do not connect an external voltage, i.e. also no analog input voltage in the range up to 10 V, to the sensor inputs 1 and 2. An external voltage will destroy the temperature module and the power supply/CPU module.

The analog inputs I11 (IA03) and I12 (IA04) are used for analog value measurement between 0 V - 10 V (10-bit resolution; 0 - 1023). These inputs can also be used as digital inputs, → Figure 51, page 67.

A separate sensor monitoring is provided for an activated temperature input. It monitors:

- Short-circuit.
- Wire breakage or sensor errors.
- Out of range values.

This type of error is indicated by a diagnostics contact (↔ Section "9.3 Diagnostics", page 479).

Modules with ..TAP13.. in their designation are provided with an additional analog output.

Table 7: I/O module MFD-TP.../MFD-TAP... and sensor type

Designation	Sensor type	Measuring range	Resolution	Accuracy
MFD-TP12-PT-A (MFD-TAP13-PT-A)	Pt100	-40...+90 °C	12 Bit (0.03 °C)	0.6% (~0.8 °C)
		0...+250 °C	12 Bit (0.06 °C)	0.6% (~1.5 °C)
		0...+400 °C	12 Bit (0.1 °C)	0.6% (~2.4 °C)
MFD-TP12-PT-B (MFD-TAP13-PT-B)	Pt100	0...+850 °C	12 Bit (0.21 °C)	0.6% (~5.1 °C)
		-200...+200 °C	12 Bit (0.1 °C)	0.6% (~2.4 °C)
MFD-TP12-NI-A (MFD-TAP13-NI-A)	Ni1000	-40...+90 °C	12 Bit (0.03 °C)	0.6% (~0.8 °C)
		0...+250 °C	12 Bit (0.06 °C)	0.6% (~1.5 °C)

2.5.3.3 Connecting analog inputs of the EASY4..-DC-ME expansion units

These DC expansion units allow you to process analog values of voltage, current and temperature. The EASY4..-DC-ME DC expansion units convert analog input and output values with a 10-bit resolution (0 - 1023). When a Pt100 sensor is connected, the DC expansion units operate in the range between -50 °C and 200 °C.



You process the analog input and output values using permanently assigned marker words (MW) which you configure and program in easySoft-Pro

The DC expansion units are provided with digital inputs/outputs as well as analog inputs/outputs (→ Section "2.5.2.4 Connecting DC inputs of the EASY4..-DC-ME expansion units", page 69).

2 Installation

2.5 Connecting inputs

Two devices are available:

- With the EASY406-DC-ME you can read one voltage, current or temperature analog value via the first analog input (terminals 2 - 6) and via the second analog input (terminals 7 - 11).
- The EASY411-DC-ME allows you to evaluate measured values at the same time via the six analog inputs (terminals 2...11), and read voltage, current or temperature analog values via two inputs each.

Table 8: Terminals of the analog inputs on the EASY4...DC-ME expansion devices

Terminal(s)	EASY406-DC-ME	Meaning	EASY411-DC-ME	Meaning
2	1. Analog value	0 - 10 V, 0(4)-20 mA or PT100 resistance sensor	1. Analog value	0 - 10 V
3	1. Analog value		2. Analog value	0(4)-20 mA
4, 5, 6	1. Analog value		3. Analog value	PT100 resistance sensor
7	2. Analog value	0 - 10 V, 0(4)-20 mA or PT100 resistance sensor	4. Analog value	0 - 10 V,
8	2. Analog value		5. Analog value	0(4)-20 mA
9, 10, 11	2. Analog value		6. Analog value	PT100 resistance sensor

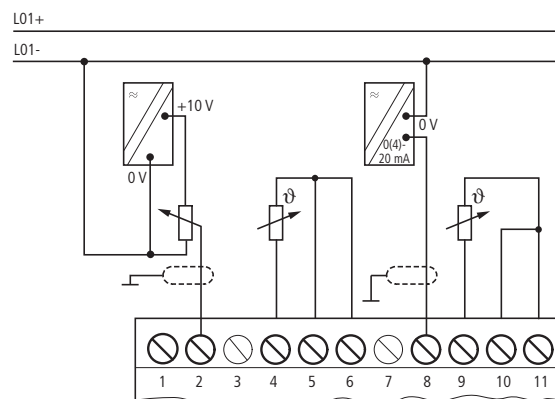

Figure 59: Connection of the analog inputs on the EASY4...DC-ME expansion devices

Voltages are measured in the 0 - 10 V signal range. A potentiometer with an upstream resistor that is connected between the supply voltage and reference potential can be used as a setpoint potentiometer. For voltage measuring, connect the output of the sensor to the voltage input (terminal 2 or 7), → section "Figure 56: Setpoint potentiometer with upstream resistor", page 71.

Currents are measured in the 4 - 20 mA (0 - 20 mA) signal range. For current measurement connect the output of the sensor to the current input (terminal 3 or 8), → section "Temperature, brightness and 20 mA sensor", page 71.



When current measuring is activated, we recommend the implementation of wire break detection via the diagnostics contact R13. The expansion unit switches the diagnostics contact to the 1 state if a current < 3 mA is present. Use current sensors for the 4 - 20 mA signal range if you wish to evaluate the diagnostics contact.

Temperatures are measured in the range $-50\dots+200$ °C using PT100 temperature sensors. The sensor inputs 1 (terminal 4 - 6) and 2 (terminal 9 - 11) are used for temperature measuring.

On terminals 6 and 11, the analog expansion unit outputs a constant current to the temperature sensor.

Connect the ground connection of a sensor to the corresponding 0 V input (terminal 4 or 9) of the expansion unit.

You connect the temperature sensor directly to the relevant three terminals of these sensor inputs. A three-wire connection or a two-wire connection is possible.

With three-wire measuring, the line resistance is compensated by means of a measuring bridge in the expansion unit.

With two-wire connections, connect a short-circuit bridge between terminals 5 and 6 or 10 and 11 (→ Figure 59, page 74).



The inputs and outputs of these analog expansion units require the same reference potential (chassis ground) as the DC power supply of the sensors and actuators. Connect the 0V of the DC power supply of the different sensors with the 0V of the DC power supply of the expansion unit.

2.6 Connecting outputs

Devices either have transistor outputs or relay outputs. The Q... outputs of both device versions are potentially isolated from the power supply and the inputs, and therefore operate as potential-free contacts.

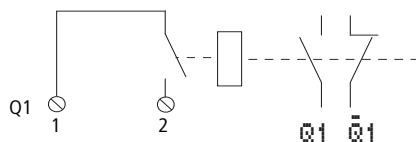

Figure 60: Connecting outputs, in this case Q 1

The respective relay coils are actuated in the circuit diagram via the Q 01 to Q 04 or S 01 to S 06 (S 08) output relays.

You can use the signal states of the output relays as N/O or N/C contacts in the circuit diagram for additional switching conditions.

2 Installation

2.6 Connecting outputs

The relay or transistor outputs are used to switch loads such as fluorescent tubes, filament bulbs, contactors, relays or motors. Prior to installation observe the technical limit values and data for the outputs (→ Section "11.2.1 MFD-80.. display/operator unit", page 495).

See also:

- "Connecting relay outputs", page 76.
- "Connecting digital transistor outputs", page 78.
- "Connecting analog outputs", page 80.

The number of outputs of the basic devices can be increased by using an expansion unit. The outputs of the EASY202-RE, EASY4.-DC-.E and EASY6.-DC-. digital expansion units are detected by the basic device automatically - without any configuration.

The universal EASY4.-DC-ME expansion units allow you to process both digital and analog values. The digital outputs of these expansion units are detected by the basic device automatically - without any configuration.



The factory activated analog outputs can also be processed immediately, but should always be adapted to your application during commissioning, → Section "3.6 Configuring the analog expansion unit", page 117.

All available input/output expansions → section "1.4 Possible combinations of basic devices and expansion units", page 24.

2.6.1 Connecting relay outputs

2.6.1.1 Connecting the relay outputs of the basic device

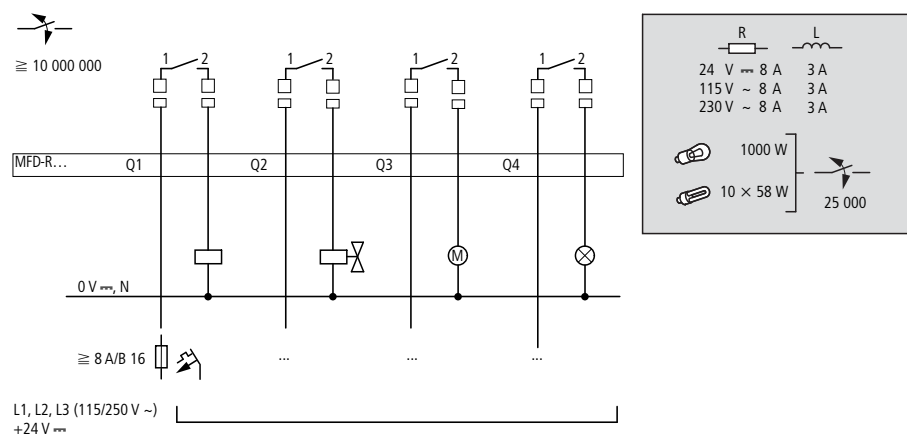

Figure 61: MFD-R relay outputs



DANGER

Do not exceed the maximum voltage of 250 V AC on a relay contact. If the voltage exceeds this threshold, flashover may occur at the contact, resulting in damage to the device or a connected load.

2.6.1.2 Connecting the relay outputs of the expansion unit

EASY4...-RE/EASY6...-RE

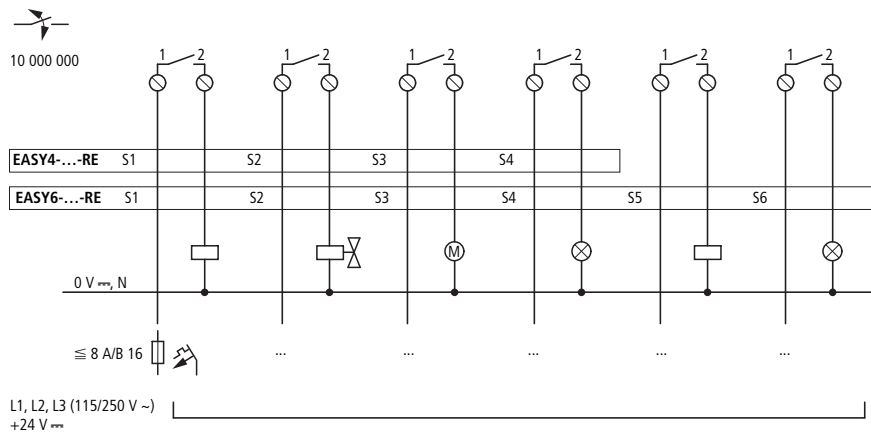

R	L
24 V ~ 8 A	3 A
115 V ~ 8 A	3 A
230 V ~ 8 A	3 A
1000 W	25 000
10 × 58 W	

Figure 62: EASY4...-RE/EASY6...-RE relay outputs

EASY2...-RE

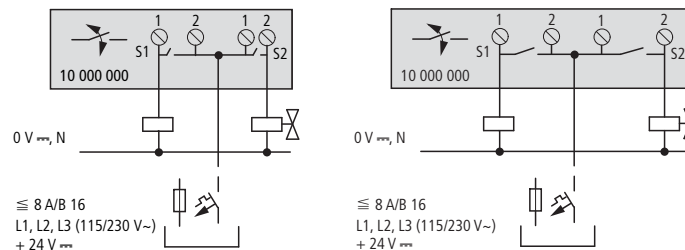

Figure 63: EASY2...-RE relay outputs

Unlike the connection of the inputs, you can connect different phase conductors to the relay outputs of the MFD-R.. devices.

2 Installation

2.6 Connecting outputs

2.6.2 Connecting digital transistor outputs

2.6.2.1 Connecting transistor outputs of the basic device

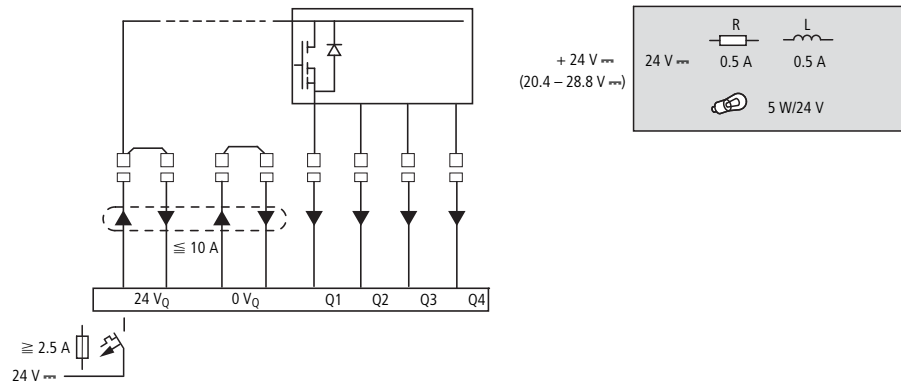

Figure 64: Digital transistor outputs of the MFD-T... I/O modules and MFD-TP.../MFD-TAP...

➔ Power the transistor outputs with voltage!

2.6.2.2 Connecting transistor outputs of the expansion unit

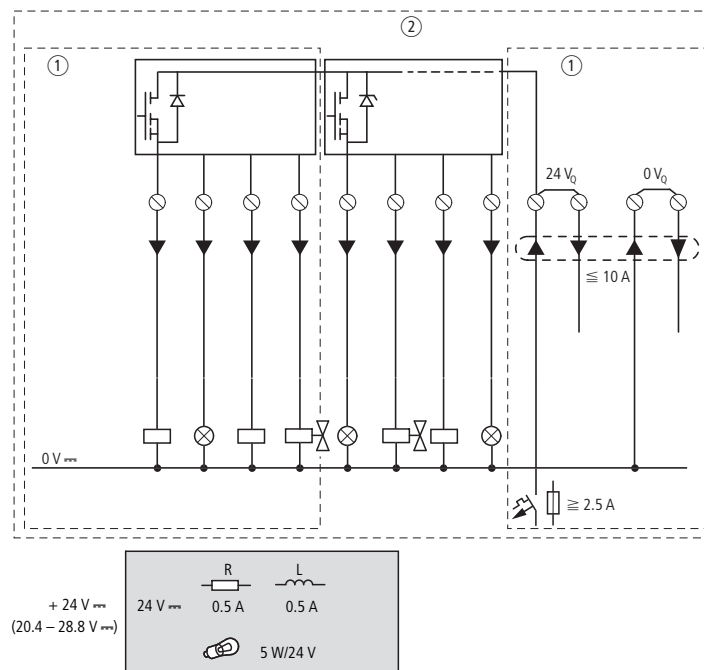

Figure 65: Digital transistor outputs EASY6...-DC-TE and EASY4...-DC-TE

- ① EASY4... -DC-TE
- ② EASY6... -DC-TE

Parallel connection

Up to four outputs can be connected in parallel in order to increase the power. This enables a maximum output current of 2 A.



DANGER

Only outputs of the same group (S1 to S4 or S5 to S8) can be connected in parallel; e.g. S1 and S3 or S5, S7 and S8. Outputs connected in parallel must be switched at the same time.



DANGER

Please note the following when switching off inductive load.

- Suppressed inductances cause less interference in the entire electrical system. It is recommended that the suppressor circuit is connected as close to the inductance as possible.

If inductive loads are not suppressed, the following applies:
Several inductive loads should not be switched off simultaneously to avoid overheating the driver blocks in the worst possible case. If in the event of an emergency stop the +24 V DC power supply is to be switched off by means of a contact, and if this would mean switching off more than one controlled output with an inductive load, then you must provide suppressor circuits for these loads (→ Figure 66, page 79).

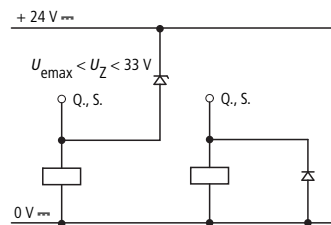

Figure 66: Inductive load with suppressor circuit

2.6.2.3 Behavior in the event of a short-circuit/overload

A transistor output will switch off in the event of a short-circuit or overload. The output will switch back on up to the maximum temperature after a cooling time that depends on the ambient air temperature and the current level. If the fault condition persists, the output will keep switching off and on until the fault is corrected or until the power supply is switched off (→ Section "9.3 Diagnostics", page 479).

2 Installation

2.6 Connecting outputs

2.6.3 Connecting analog outputs

All power supply/CPU modules with a 24V DC power supply can be fitted with an MFD-A17 standard I/O module or an MFD-TAP... I/O module as a basic unit, each have one QA 01 analog input. QA 01 enables you to output a DC voltage of 0 - 10 V.

- Standard I/O module, type MFD-RA.. and MFD-TA.., 10-bit resolution, value range 0 - 1023
- I/O module type MFD-TAP.., 12-bit resolution, value range 0 - 4095.

It is also possible on the MFD to connect the EASY406-DC-ME and EASY411-DC-ME DC expansion units with an analog output (→ Section "2.5.2.4 Connecting DC inputs of the EASY4..-DC-ME expansion units", page 69).

The analog output can be used, for example, for controlling solenoid valves and other actuators.

Observe the hazard warnings concerning the processing of analog signals (→ section "2.5.3 Connecting analog inputs", page 69) and the note concerning the same reference potential (chassis ground).

2.6.3.1 Connecting analog output of the MFD-.A17 and MFD-TAP... basic devices

Connect the actuator to QA1 and to the 0V terminal on its left.

Connecting servo valves

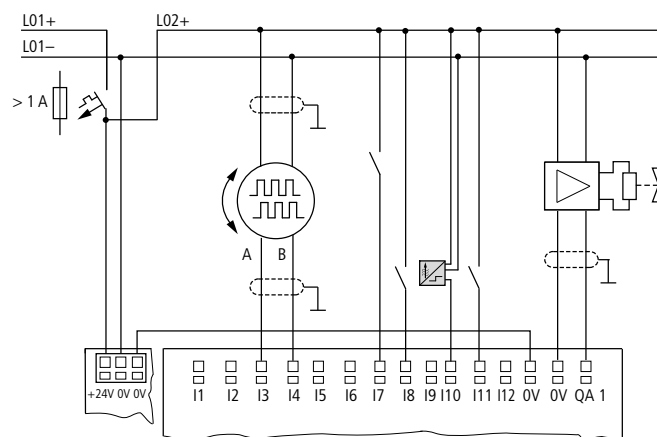

Figure 67: Connecting servo valves

Setpoint entry for a drive

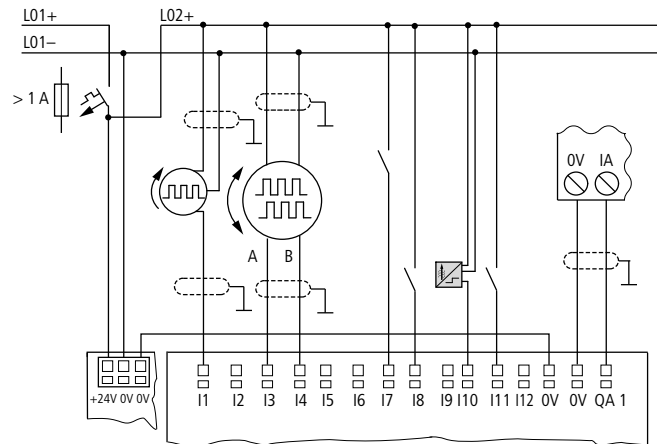

Figure 68: Setpoint entry for a drive

2.6.3.2 Connecting analog output of the EASY4..-DC-ME expansion units

Analog expansion units are used to increase the number of outputs. The EASY406-DC-ME analog expansion unit offers you one and the EASY411-DC-ME two additional analog outputs. Both devices provide a DC voltage of 0 - 10 V with a 10-bit resolution, value range 0 - 1023. Connect the actuator(s) to QA1(QA2) and to the relevant 0 V terminal to its left.

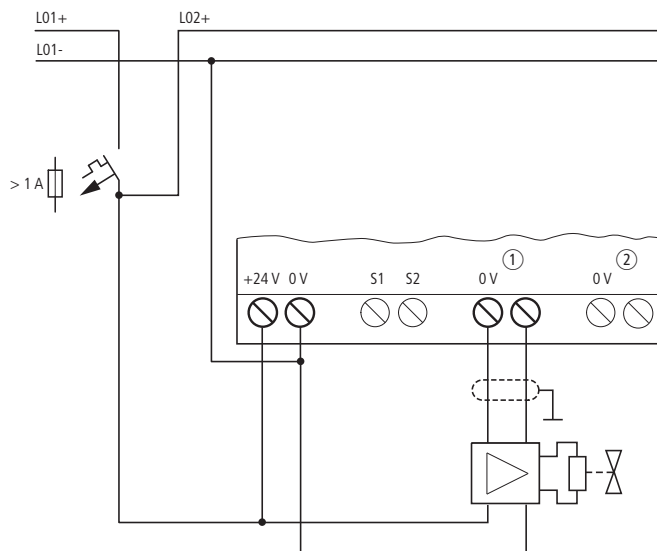

Figure 69: Connecting the analog output of an EASY4..-DC-ME expansion unit

- ① Analog output QA1 (EASY406.../411...), 0 - 10 V,
- ② Analog output QA2 (only EASY411...), 0 - 10 V.



Then configure the analog inputs/outputs you have connected,
→ Section "3.6 Configuring the analog expansion unit",
page 117.

2 Installation

2.7 Connecting the easyNET network

2.7 Connecting the easyNET network

easyNet is a network to which a maximum of 8 stations can be connected. Any device with a network connection (MFD-...-NT) can be an easyNet station.

Further information on configuring and commissioning the easyNet
→ Chapter 7 "The network easyNet", page 437. Specifications for the easyNet are provided in the Technical Data, page 515.

2.7.1 Connection assignment of the RJ45 socket on the device

The networkable devices are provided with two RJ45 sockets.

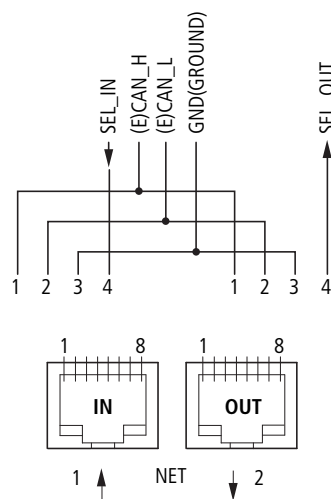





Figure 70: RJ45 socket

Socket 1 (IN) is used for connecting the incoming data cable from the physically preceding easyNet station. Socket 2 (OUT) is used for connecting the outgoing data cable to the physically next easyNet station.

The physically first and last easyNet stations must be terminated with a bus terminating resistor. As there is not a station in front of the physically first easyNet station, the bus terminating resistor is fitted in socket 1. The bus terminating resistor for the last easyNet station is plugged in socket 2 accordingly.

2.7.1.1 Assignment of the easyNet connection cable

4 core, twisted pair; → Section "11.2.1 MFD-80.. display/operator unit", page 495.

	Cable pair	Pen	Line
	CSA	1	Data cable ECAN_H
	CSA	2	Data cable ECAN_L
	B	3	Ground cable GND (Ground)
	B	4	Select cable SEL_IN



The most basic easyNet configuration operates with the cables ECAN_H, ECAN_L, GND. The SEL_IN cable is only used for automatic addressing and configuration.

2.7.2 Bus termination resistor

The physically first and last stations in the easyNET network must each be terminated with a bus termination resistor.

- Value: 124 Ω.,
- Connection plug : EASY-NT-R.

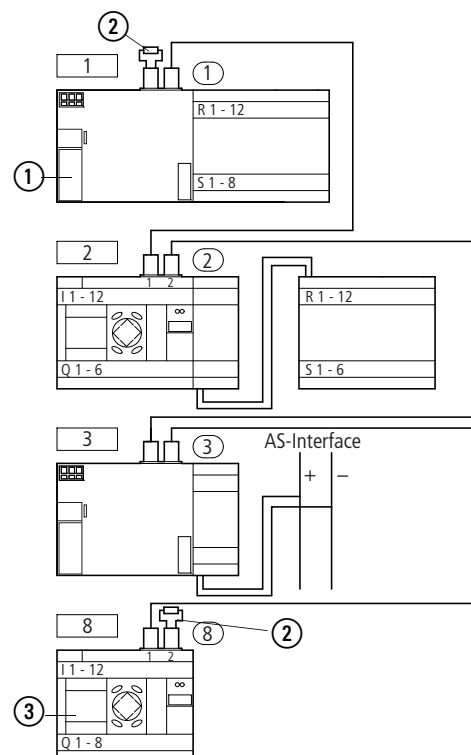



Figure 71: Bus Terminating Resistors

- ① First station on the easyNet
- ② Bus termination resistor
- ③ Last station on the EasyNET network
-  Physical location, place
-  Station number

2 Installation

2.7 Connecting the easyNET network

2.7.3 Pre-assembled easyNet connection cables

The following easyNet connection cables are available for simple installation:

Table 9: Prefabricated cables, RJ45 plug on both ends

Cable length cm	Part no.
30	EASY-NT-30
80	EASY-NT-80
150	EASY-NT-150

2.7.4 User-assembled easyNet connection cables

The following components are available for assembling different cable lengths:

- Connection cable
 - Type - EASY-NT-CAB, cable 100 m, 4 x 0.18 mm².
- Bus connection plug
 - RJ45 plug, part no.: EASY-NT-RJ45 (8-pole)
- Tools
 - Crimping tool for RJ45 plug, part no.: EASY-RJ45-TOOL. AWG 24, 0.2 mm² is the largest crimpable cross section.



The table on page 87 provides information for the required cable cross-section of longer cable lengths, taking the cable resistance into account.

2.7.5 Fitting and removing easyNet connection cables

Both RJ45 interfaces are visible after the cover plate has been removed.

When a cable is plugged in, it must snap into the socket with an audible click **1**.

Before a plug or cable is removed, the mechanical interlock must be undone **2**, **3**.

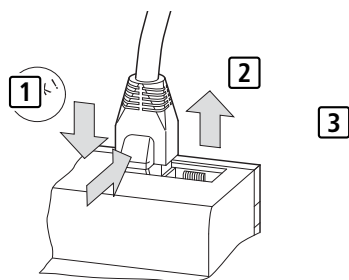

Figure 72: Plugging and unplugging cables

2.7.5.1 easyConnecting Net stations

Proceed as follows in order to connect the easyNet stations:

- Plug in the easyNet connection cable into the easyNet socket 2 of the first physical easyNet station.
- Plug in the easyNet connection cable into the easyNet socket 1 of the last physical easyNet station.
- Fit the bus terminating resistor in socket 1 of the first station and in socket 2 of the last station.
- Connect the power supply to all stations.

2.7.6 easyNet-topologies

easyNet allows you to configure line topologies in which all stations are connected to a main cable. Two types of cable routing are possible:

- Loop-through cable routing.
- Wiring arrangement using a T connector and a spur line.

2.7.6.1 Passing through

Advantage: With this wiring arrangement, the cable is looped through the device. The easyNet stations can be addressed and easyNet configured very simply via station 1 (→ section "Parameter setting", page 125) or via easySoft-Pro.

Disadvantage: If the line is interrupted, the easyNET network is no longer operational from this point in the network.

2.7.6.2 T connector and spur line.

Advantage: If an easyNet station fails, the spur line can be removed from the station for the exchange, whilst all other devices on the easyNet remain functional.

Each device must be addressed individually with this wiring method by:

- By downloading the program of the MFD configuration including the NET-ID via easySoft-Pro (see Help). For this the programming cable must be plugged in locally on each individual device.
- Via the operator buttons and display of the individual device (→ section "Parameter setting", page 125).









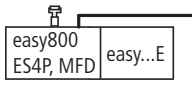
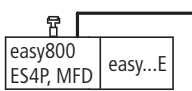

The spur line between the T connector and the device must not exceed 0.3 m. Otherwise communication via easyNET may be impaired.

Spur lines are not permitted when using the EASY223-SWIRE gateway.

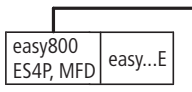
2 Installation

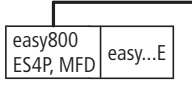
2.7 Connecting the easyNET network

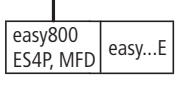
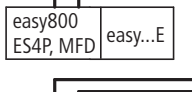
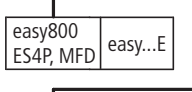
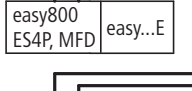
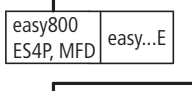
2.7.6.3 Addressing examples

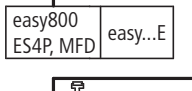
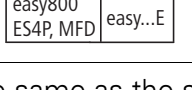
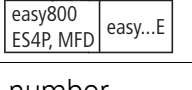
Physical location, place	Station number		"Loop through the unit"	T connector and spur line
	Example 1	Example 2		
1	1	1		
2	2	3		
3	3	4		
4	4	8		
5	5	7		
6	6	2		
7	7	6		
8	8	5		

- Example 1: Physical location is the same as the station number
- Example 2: Physical location is not the same as the station number (apart from location 1 being the same as station 1).



Physical location 1 is always assigned as station 1. Station 1 is the only station which must be present.

2.7.7 Cable length with cross-sections

For correct operation of the easyNet network the cable lengths, cross-sections and cable resistances must match those listed in the following table.

Cable length m	Cable resistance mΩ/m	Cross-section	
		mm ²	AWG
- 40	≤ 140	0.13	26
- 175	≤ 70	0.25 - 0.34	23, 22
- 250	≤ 60	0.34 - 0.5	22, 21, 20
- 400	≤ 40	0.5 - 0.6	20, 19
- 600	≤ 26	0.75 - 0.8	18
- 1000	≤ 16	1.5	16

The impedance of the cables used must be 120 Ω.



The installation of an expensive fibre optic link is recommended with cable lengths > 500 m.

The maximum transmission speed depends on the total length of the network cables, (→ Section "11.2.1 MFD-80.. display/operator unit", page 515).

2.7.7.1 Calculating the cable length for a known cable resistance

If the resistance of the cable per unit of length is known (resistance per unit length R' in Ω/m), the entire cable resistance R_L must not exceed the following values. R_L depends on the selected baud rates:

Baud rate Kbit/s	Cable resistance R_L Ω
10 - 125	≤ 30
250	≤ 25
500, 1000	≤ 12

l_{max} = Maximum cable length in m.

R_L = Total cable resistance in Ω.

R' = Cable resistance per unit length in Ω/m.

$$l_{max} = \frac{R_L}{R'}$$

2 Installation

2.8 Connecting the serial multi-function interface

2.7.7.2 Calculating cross-section with known cable lengths

The minimum cross-section is determined for the known maximum extent of the easyNET network.

l = Cable length in m

S_{\min} = Minimum conductor cross-section in mm²

ρ_{Cu} = Resistivity of copper, if not otherwise stated 0.018 Ωmm²/m

$$S_{\min} = \frac{l \times \rho_{\text{Cu}}}{12.4}$$



If the calculation result does not correspond to a standard cross section, take the next higher cross section.

2.7.7.3 Calculating length with known cable cross-section

The maximum cable length for a known conductor cross-section is calculated as follows:

l_{\max} = Cable length in m

S = Conductor cross-section in mm²

ρ_{Cu} = Resistivity of copper, if not otherwise stated 0.018 Ωmm²/m

$$l_{\max} = \frac{S \times 12.4}{\rho_{\text{Cu}}}$$

2.8 Connecting the serial multi-function interface

Each MFD device is provided with a serial multi-function interface that is integrated in the power supply/CPU module.

The interface is factory shipped with a protective cover fitted. Remove this cover carefully.

The serial multi-function interface is used for:

- connecting the programming cable to the COM serial interface on the PC and thus as a connection for the easySoft programming software ("PC interface" function).
- the point-to-point connection between an MFD-CP4 (→ MN05013011Z-DE; previously AWB2528-1548D) or MFD-CP8./CP10.. in terminal operating mode (→ section "3.9 Running MFD in Terminal mode", page 136) and an MFD device. the point-to-point communication between an MFD in COM-LINK operating mode and an MFD device. Information on the COM-Link interface → section "3.8 COM-LINK connection", page 132.
- the communication via the EASY209-SE Ethernet gateway with an Ethernet network, see manual EASY209-SE Ethernet Gateway, MN05013012Z-EN; previously AWB2528-1596GB.
- a memory card ("memory interface" function).

2.8 Connecting the serial multi-function interface

The following shows the permissible programming cables for connecting your MFD device via the multi-function interface.

2.8.1 Connection to a PC

2.8.1.1 Local connection

Connect one of the following programming cables to the COM or USB interface of your PC and to the serial multi-function interface of the MFD device.

Table 10: Programming cable for the connection to a PC

Device	Programming cable	Baud rate
EASY800/MFD	EASY800-PC-CAB	19.2 Kbit/s
EASY800/MFD	EASY800-USB-CAB	57.6 Kbit/s
EASY800/MFD	EASY800-MO-CAB	57.6 Kbit/s, universal high-speed cable

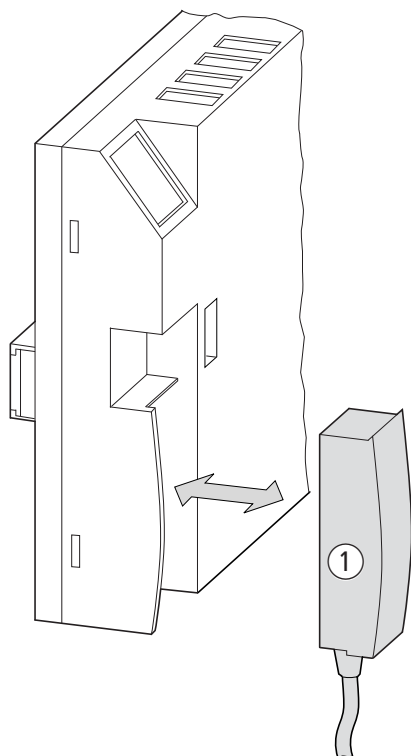

Figure 73: Fitting the programming cable ① to an MFD device

2 Installation

2.8 Connecting the serial multi-function interface

CAUTION

When connecting the programming cable, the easySoft-Pro programming software must be offline. On no account should the programming cable be moved from one MFD device to another when the connection is online.

2.8.1.2 Connection via a modem

To set up a connection via modems connect a standard modem to the COM port of your PC and one to the serial multi-function interface of the MFD device.

Modem parameter assignment

- Transfer speed 9.6 Kbit/s.
- Data format 8-N-1.

easySoft parameter assignment

Requirement for assigning easySoft parameters: The easySoft-Pro programming software must be offline.

- ▶ In the Communication menu, choose Interface, Baudrate and select the value 9600 bit/s, and in the Timeout Time menu enter a value of at least 1000 ms in the PC => Local Device field.

Allow for the additional dial-in and transfer time for a modem connection. In some cases a time > 1000 ms is required.

Connecting the modem

- On the PC side connect the modem via a null modem cable on which RxD and TxD are reversed.
- Connect the MFD device to the modem via an EASY800-MO-CAB.

Table 11: Tab. SUB-D connector assignment on the EASY800-MO-CAB for modem operation

Modem SUB-D 9-pole, Pin	Wire color of the EASY800-MO-CAB
2	brown
3	white
4	gray
5	green
6	yellow

CAUTION

If you are connecting the MFD device alternately via a modem connection (9.6 Kbit/s) and then locally via a universal high-speed cable (up to 57.6 Kbit/s), the transfer speed for the MFD device must be reset to 9.6 Kbit/s if the slower modem connection is accessed after using the local connection.

The timing requirements for fault-free data exchange via the serial multi-function interface are described in → section "9.6 Monitoring the COM-LINK connection", page 483.

2.8.2 Connecting for point-to-point communication

Connect one of the connecting cables → Table 12 to an MFD-...-CP8/CP10 or MFD-...-CP4 and to the serial multi-function interface of the MFD device.

Table 12: Connection cable on an MFD-CP4/CP8... for point-to-point communication

Device	Connection cable	Baud rate
EASY8../MFD	MFD-800-CAB5, MFD-CP4-800-CAB5 for operation on an MFD-...-CP8/CP10	up to 19.2 Kbit/s
EASY8../MFD	MFD-CP4-800-CAB5 for operation on an MFD-...-CP4	up to 19.2 Kbit/s



In order ensure compliance with EMC requirements, the MFD-800-CAB5 cable must not be lengthened.

2 Installation

2.8 Connecting the serial multi-function interface

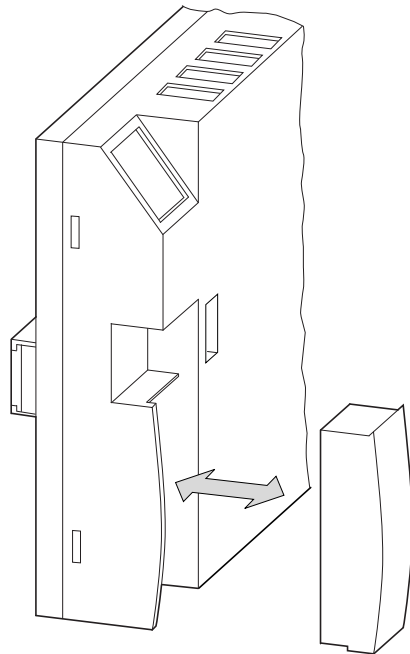

Figure 74: Fitting/removing the interface cover.

- ▶ Remove the cover from the interface and connect the connector plug.

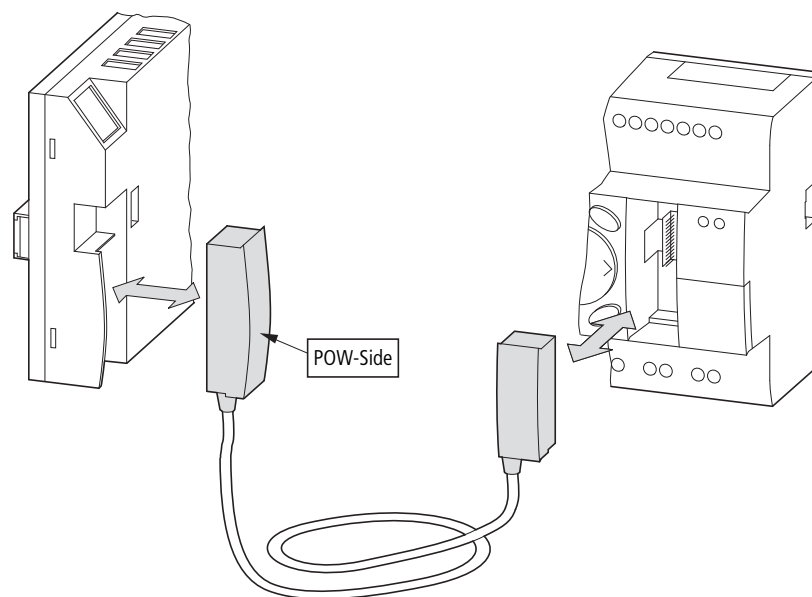

Figure 75: Fitting the connection plug: left MFD-...-CP8/CP10 with plug "POW-Side"



The connector marked POW-Side must be plugged into the interface of an MFD. The serial interface only functions if the MFD device is providing the power feed required for the interface cable.

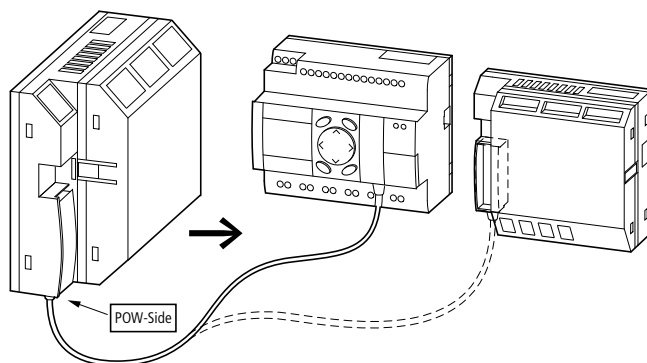

Figure 76: Point-to-point serial interface

2.8.3 Inserting the memory card

The MFD devices support the use of memory cards that are inserted in the serial multi-function interface. The memory card can be used to store a single program that can be read from any suitable MFD device.

For easy800 and MFD-... CP8 only use the EASY-M-256K card. Use the EASY-M-512K on the MFD-CP10... for storing and reading a program.

➔ The ES4A-MEM-CARD1 memory card cannot be read or written by an easy800 or MFD device.

▶ Remove the cover from the interface and connect the connector memory card ➔ Figure 77, page 94.

➔ With MFD devices you can also remove or insert the memory card when the power supply is switched on without any risk of data loss.

How to use the memory card ➔ Section "Program transfer from and to the memory card" on page 158 .

2 Installation

2.8 Connecting the serial multi-function interface

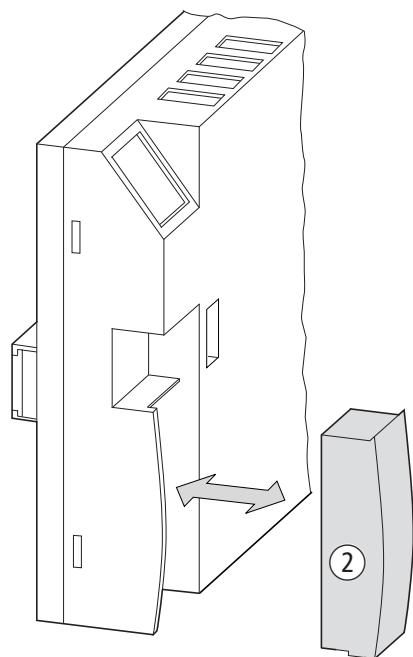

Figure 77: Connecting and removing the memory card b

3 Commissioning

3.1 Switch-on

Before startup check whether the power supply, inputs, outputs, the serial interface and the easyLink connection are properly connected:

- 24 V DC version:
 - Terminal +24 V: Voltage +24 V
 - Terminal 0 V: Voltage 0 V.
 - Terminals I1 -I12 and R1 to R12 (expansion unit) :
actuation via +24°V.
 - Terminals Q1 to Q8.
 - Terminals S1-S8 (expansion unit).
- 230 V AC version:
 - Terminal L: Main pole L
 - Terminal N: Neutral conductor N
 - Terminals I1-I12 and R1-R12 (expansion unit):
actuation via main pole L.
 - Terminals Q1 to Q6.
 - Terminals S1-S6 (expansion unit).



DANGER

If you have already integrated devices into a system, secure any parts of the system connected to the operating range to prevent access and ensure that no-one can be injured if, for example, motors start up unexpectedly.

3.2 Setting the menu language

When you switch on the MFD device for the first time, you will be asked to select the menu language.



- ▶ Use the cursor buttons \wedge or \vee to select the language required.
 - English
 - German
 - Italian
 - French
 - Spanish
 - Italian
 - Portuguese
 - Dutch
 - Polish
 - Russian.
 - Swedish.
 - Turkish.
 - Czech.
 - Hungarian.

3 Commissioning

3.3 Operating modes

- ▶ Press OK to confirm your choice and press ESC to exit the menu. The device will then switch to the status display.

The menu language setting is a MFD device function. Even when the circuit diagram is deleted this does not result in the loss of the setting selected.



You can change the language setting at a later time, (→ Section "Changing the menu language", page 461). If you do not set the language, the MFD-device will display this menu every time you switch on and wait for you to select a language.

3.3 Operating modes

An MFD device knows the operating modes RUN, STOP, BUSY and TERMINALMODE. To TERMINALMODE → section "3.9 Running MFD in Terminal mode", page 136.

3.3.1 RUN, STOP, TERMINAL MODE and BUSY

The device only assumes BUSY mode temporarily if:

- a program transfer with easySoft-Pro is in progress or
- if you are starting the program.

In RUN mode the stored circuit diagram is run continuously until STOP is selected, the device is switched to TERMINAL MODE or the power supply is switched off. or the power supply is switched off.

The circuit diagram, MFD parameters and the easy settings are retained in the event of a power failure. All you will have to do is reset the real-time clock after the back-up time has elapsed. In RUN mode:

- the process image of the inputs are read.
- circuit diagram is processed.
- the visualization is shown.
- the process image of the outputs is transferred to the physical outputs.

In STOP mode, the circuit diagram is not executed and the visualization is not shown. Only in this mode is circuit diagram entry, modification of the system parameters or configuration of the easyNet possible. It is also possible to store the circuit diagram and the visualization on the external memory card or load them from the external memory card. In this mode, a circuit diagram can also be transferred from and to easySoft-Pro.

The switch from RUN to STOP and vice versa is carried out in the main menu.

```
PROGRAM...   ↑
STOP ✓ RUN
PARAMETER
SET CLOCK   ↑
```



DANGER

In RUN mode, an MFD device processes a stored circuit diagram immediately after the power supply is switched on. The outputs are activated according to the switch logic of the circuit diagram.

Configure your machine/plant so that the automatic starting of the MFD device never causes unintentional starting of the machine/plant concerned.

Create your circuit diagram so that a defined and safe startup procedure is always provided after the power supply is switched on. Information on startup behaviour is provided on → section “Behaviour during upload/download to card or PC”, page 453.

The device does not start with RUN mode if you deactivate RUN MODE (exception: devices without display).

MFD devices without display and function keys have a different startup behavior. The RUN START and CARD START functions are activated automatically in this case, since no device operations for manual starting are possible. More information on the CARD START function is provided on → section “8.2.3.2 CARD MODE”, page 453.

3.3.1.1 Startup behavior of MFD devices without display and operating buttons

The MFD variant without display or without a display and operating unit automatically transfer the program from the memory card to the device when the supply voltage is switched and the memory card is fitted.

The device will then process the circuit diagram in RUN mode.



If you are using a display module without a keypad and have not fitted a memory card, you can load the programs conveniently with the easySoft-Pro software.

If programs in the MFD and on the memory card are different, the program in the MFD is overwritten when the supply voltage is switched on with a memory card fitted.

3.4 The first circuit diagram

The following provides a step by step example of how to wire your first circuit diagram. In this way you will learn all the rules, quickly enabling you to use an MFD device for your own projects.

As with conventional wiring, you use contacts and relays in the diagram.

The MFD device saves you having to use and wire different components. At the push of a few buttons, the MFD circuit diagram produces all the wiring required. All you have to do is then connect any switches, sensors, lamps or contactors you wish to use.

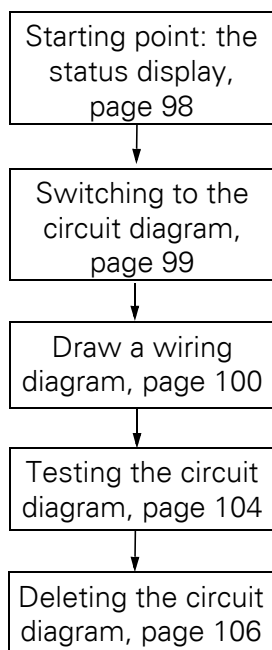
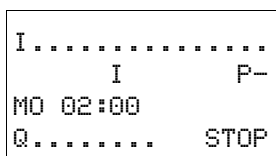

Figure 78: Overview for “first circuit diagram”

3.4.1 Starting point: the status display



When you switch on an MFD device, it opens the status display immediately. This status display shows the switching state of the inputs and outputs and also indicates whether the device is currently running a circuit diagram.



If after power up, a different display appears instead of the status display, the MFD is either showing a visualization screen or the start screen of TERMINAL MODE.

Requirement for circuit diagram entry: the MFD device must be in STOP mode.



The examples do not involve the use of expansion units. If an expansion unit is connected, the status display will first show the status of the basic device and then the status of the expansion unit before showing the first selection menu.

3.4.2 Switching to the circuit diagram

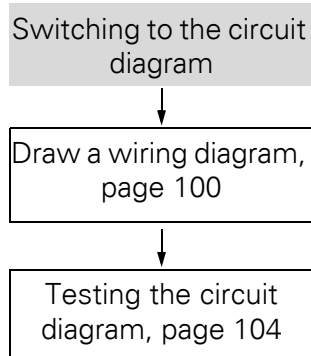

```

PROGRAM...
STOP ✓ RUN
PARAMETER
SET CLOCK...
  
```

- ▶ Press OK to switch to the main menu.

The PROGRAM menu option must then be selected on the MFD device. In general, press OK to switch to the next menu level, and press ESC to move one level back.

```

CIRCUIT DIAGRAM
FUNCTION BLOCKS
  
```

- ▶ Press OK twice to enter the circuit diagram display via menu options <PROGRAM -> CIRCUIT DIAGRAM>. This is where you will create the circuit diagram.

3.4.2.1 Circuit diagram display

```

█
L: 1 C:1 B:
  
```

The circuit diagram display is currently empty. The cursor flashes at the top left, which is where you will start to create your diagram.

The position of the cursor appears in the last line of the display:

- L: = Rung (**L**ine).
- C: = Contact or coil field (**C**olumn).
- B: = Amount of free memory in **B**ytes.

The circuit diagram supports four contacts and one coil in series. The display shows 6 fields of the circuit diagram.

3 Commissioning

3.4 The first circuit diagram

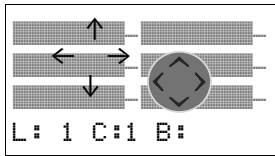

Use the ^ v < > cursor buttons to move the cursor over the invisible circuit diagram grid. The first four columns are contact fields, the fifth column is a coil field. Each line is a circuit connection. MFD automatically connects the contact to the power supply.

► Now wire the circuit diagram as described below.

3.4.3 Draw a wiring diagram

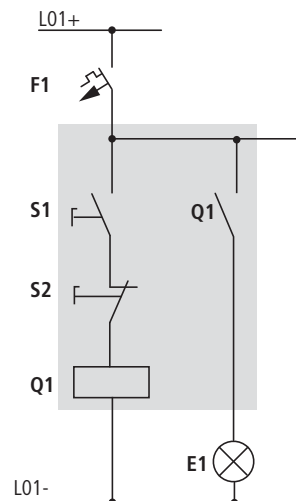
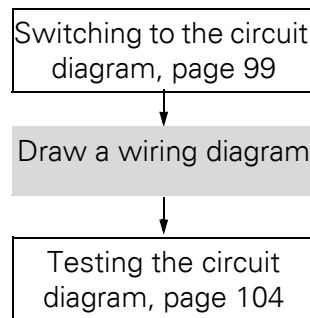

Figure 79: Lamp controller with relays

In the following example, the MFD device carries out all the wiring and performs the tasks of the circuit diagram shown below.

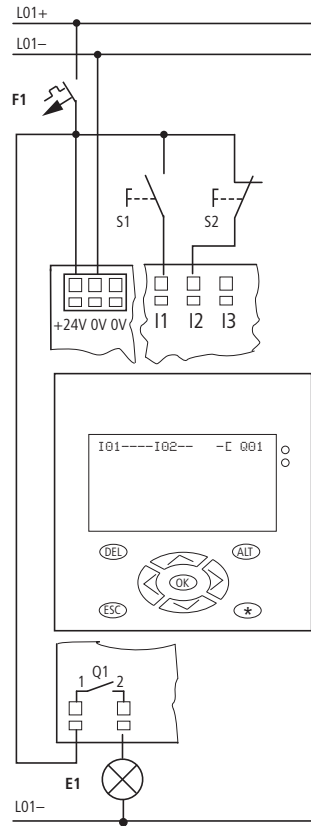

Figure 80: Lamp control with an MFD device

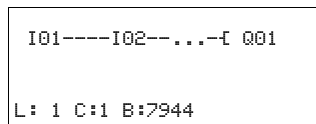

Figure 81: Circuit diagram with inputs I01, I02 and output Q01

With this example the switches S1 and S2 are at the input. I01 and I02 are the switch contacts for the input terminals in the circuit diagram.

The relay Q1 is represented in the standard circuit diagram by the relay coil [- Q01 .

The symbol [- identifies the coil's function, in this case a relay coil acting as a contactor. Q01 is one of the MFDdevice's outputs.

3 Commissioning

3.4 The first circuit diagram

3.4.3.1 From the first contact to the output coil

With MFD devices wire from the input to the output. The first input contact is I01.

```
I01
L: 1 C:1 B:
```

- ▶ Press OK.
MFD proposes the first contact I01 at the cursor position.

I flashes and can be changed, for example, to a P for a pushbutton input using the cursor buttons ^ or v. However, nothing needs to be changed at this point.

```
I01 █
L: 1 C:1 B:
```

- ▶ Press OK twice, to move the cursor across the 01 to the second contact field.

You could also move the cursor to the next contact field using the cursor button.

```
I01 I01
L: 1 C:2 B:
```

- ▶ Press OK.
Again, inserts MFD a contact I01 at the cursor position.

- ▶ Press OK so that the cursor jumps to the next position and press cursor button ^ or v to change the number to 02.



Press DEL to delete a contact at the cursor position.

```
-I02 █
L: 1 C:3 B:
```

- ▶ Press OK to move the cursor to the third contact field.
You do not need a third relay contact, so you can now wire the contacts directly up to the coil field.

3.4.3.2 Wiring

MFD device displays a small arrow  in the circuit diagram when creating the wiring.

Press ALT to activate the wiring arrow cursor and use the cursor buttons ^ v < > to move it. Pressing ALT once more switches the cursor back to Move mode.



ALT also has two other functions depending on the cursor position:

- In the left contact field, you can press ALT to insert a new empty circuit connection.
- The contact under the cursor can be changed between a N/O and N/C contact by pressing the ALT button.

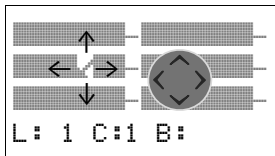

The wiring arrow works between contacts and relays. When you move the arrow onto a contact or relay coil, it changes back to the cursor and can be reactivated if required.



The MFD device automatically connects adjacent contacts up to the coil.

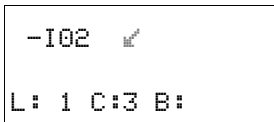

▶ Press ALT to wire the cursor from I02 through to the coil field. The cursor changes into a flashing wiring arrow and automatically jumps to the next logical wiring position.

▶ Press the cursor button >. Contact I02 will be connected up to the coil field.



You can use DEL to erase a connection at the cursor or arrow position. Where connections intersect, the vertical connections are deleted first, then, if you press DEL again, the horizontal connections are deleted.

▶ Press the cursor button > again.

The cursor will move to the coil field.

▶ Press OK.

The specified coil function I and the output relay Q01 are correct and do not have to be changed.

Your result will look as follows:

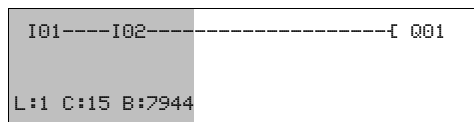
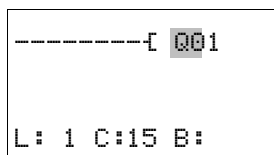

Figure 82: Your first wired and functional circuit diagram

■ = Visible area

▶ Press ESC to leave the circuit diagram display. The SAVE menu appears.

3.4.3.3 Saving

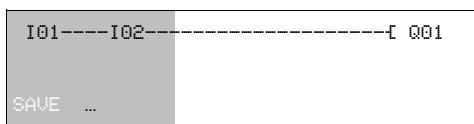

Figure 83: SAVE menu

■ = Visible area

▶ Confirm with OK.

The circuit diagram is stored.

3 Commissioning

3.4 The first circuit diagram

- ▶ Press the ESC pushbutton twice to return to the main menu.

Once you have connected pushbutton S1 and S2, you can test your circuit diagram straight away.

3.4.4 Testing the circuit diagram

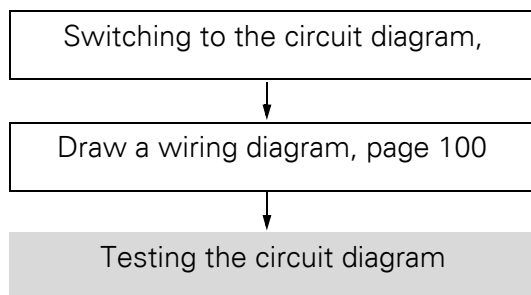

```
PROGRAM...
STOP ✓ RUN
PARAMETER
SET CLOCK...
```

- ▶ Switch back to the main menu and select the STOP RUN menu option. The current operating mode is indicated in the device display by a tick at RUN or STOP stop. Pressing the OK pushbutton enables you to toggle between the modes.

- ▶ Press the OK pushbutton in order to change to RUN.



The status display shows the current mode as well as the switching states of the inputs and outputs.

3.4.4.1 Test using the status display

```
I12.....
      I      P-
MO 14:42
Q1..... STOP
```

- ▶ Change to the status display and press pushbutton S1. Do not execute pushbutton S2.

The contacts for inputs I01 and I02 are activated and relay QS1 picks up, indicated by the highlighted numbers.

3.4.4.2 Test using the power flow display

A MFD device enables you to check the power flow in RUN mode. While the device is processing the circuit diagram in RUN operating mode, you can use the integrated power flow display to check this.

- ▶ Change to the circuit diagram display and press pushbutton S1.

The relay picks up and the MFD displays the power flow with a double line.

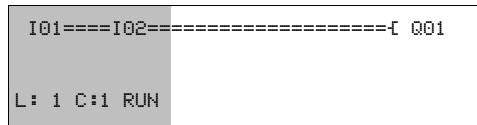

Figure 84: Power flow display: Inputs I01 and I02 are closed, relay Q01 has picked up
■ = Visible area

- ▶ Press pushbutton actuator S2, that has been connected as the N/C contact.

The power flow is interrupted and relay Q1 drops out.

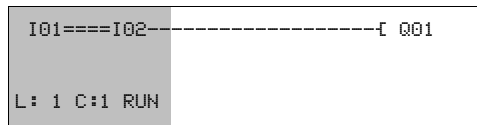

Figure 85: Power flow display: Input I01 is closed, input I02 is open, relay Q01 has dropped out
■ = Visible area

- ▶ Press ESC to return to the Status display.



The circuit diagram does not have to be completed in its entirety so that it is possible to test parts of it. The MFD device simply ignores any incomplete wiring that is not yet working and only uses the finished wiring.

Power flow display with Zoom function

With the MFD device you can check the following at a glance:

- All four contacts plus one coil in series
- 3 Rungs/Current paths
- ▶ Change to the circuit diagram display and press the ALT button. Press pushbutton S1.

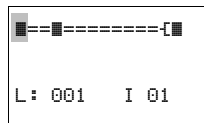

Figure 86: Power flow display in Zoom function: Input I01 and I02 are closed, relay Q01 picked up

■ Contact closed, coil is triggered:

□ Contact opened, coil not triggered.

- ▶ Press pushbutton S2, that has been connected as an N/C contact.

The power flow is interrupted and relay Q1 drops out.

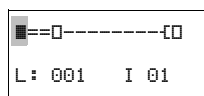

Use the cursor buttons ^ v <> to move between the contacts or coil.

3 Commissioning

3.4 The first circuit diagram

- ▶ Press the cursor button >.

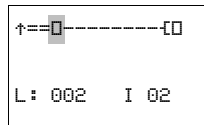

The cursor moves to the second contact.

- ▶ Press the ALT pushbutton. The display changes to display status with contact and/or coil designation.

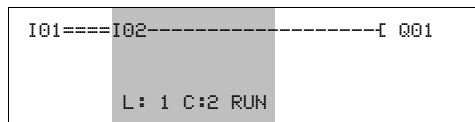

Figure 87: Power flow display: Input **I01** is closed, input **I02** is open, relay **Q1** has dropped out

 = Visible area

3.4.5 Deleting the circuit diagram

- ▶ Switch the MFD device to STOP mode.



MFD must be in STOP mode in order to extend, delete or modify the circuit diagram.

- ▶ Choose STANDARD -> PROGRAM... to switch from the main menu to the appropriate menu level.
- ▶ Select DELETE PROGRAM

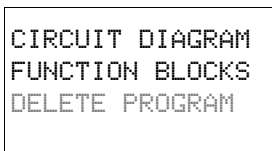

The MFD will display the prompt DELETE?.

- ▶ Press OK to delete the program or ESC to cancel.
- ▶ Pressing ESC once more returns you to the previous menu level.

3.5 I/O module with temperature measuring

The temperature modules of the MFD, MFD-TP12... and MFD-TAP13..., are provided with two analog inputs for temperature measuring and two additional inputs for analog value measuring. The temperature input 1 is permanently connected to the physical input IA01 and input 2 to physical input IA02. Part no. MFD-TAP13... temperature modules also provide a scalable analog output additionally.

The individual inputs/outputs have different parameter options:

- The inputs for temperature measuring can be assigned parameters and scaled.
- The analog inputs IA03 (terminal I11) and IA04 (terminal I12) are not parameterized. They process analog voltages in the 0 - 10 V range.
- The analog output can be parameterized and scaled.

The digital inputs I1 - I4 and the digital outputs Q1 - Q4 of the temperature modules can be used without any parameterization required.

You can carry out the parameterization conveniently with easySoft-Pro or via the buttons on the display/HMI unit as described below.

Basic requirements:

- The individual power supply/CPU, display/HMI modules and "temperature modules" must be assembled, installed, wired and the power supply connected.
- The MFD must be in STOP mode and the Status display must be showing.

3.5.1 Properties of the temperature modules

The temperature modules operate in the range for PT100 sensors from -200°C to +850°C and in the range for Ni1000 sensors from -40°C to +250 °C. The factory set temperature range is -40 °C to +90 °C. The temperature range may therefore have to be readjusted.

The fitted temperature module must be displayed in the menu. It determines the possible temperature range.

Table 13: Sensor types and displayable measuring ranges

Designation	Sensor type	Temperature range [°C]	Resolution [at 12 Bit]	Accuracy [all 0.6%]
MFD-TP12-PT-A, MFD-TAP13-PT-A	Pt100	-40 - +90	0.03 °C	~0.8 °C
		0 - 250 °C	0.06 °C	~1.5 °C
		0 - 400 °C	0.1 °C	~2.4 °C
MFD-TP12-PT-B, MFD-TAP13-PT-B	Pt100	0 - 850 °C	0.21 °C	~5.1 °C
		-200 - +200	0.1 °C	~2.4 °C
MFD-TP12-NI-A, MFD-TAP13-NI-A	Ni1000	-40 - +90	0.03 °C	~0.8 °C
		0 - 250 °C	0.06 °C	~1.5 °C

3 Commissioning

3.5 I/O module with temperature measuring

3.5.2 Menu PARAMETERS

Carry out the parameter assignment in the System menu. Choose here <CONFIGURATOR -> IO MODULES -> PARAMETERS>:

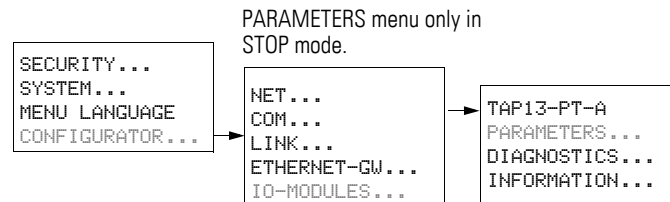

Figure 88: Menu IO-MODULE -> PARAMETER

Save your entries to complete the parameter assignment, → section “3.5.5 NEW PARAMETERS...!”, page 117.

3.5.2.1 Menu GENERAL

Starting from this menu you assign parameters for the temperature inputs and the analog output of the MFD-TAP13 temperature modules.

- ▶ Press OK to move from the PARAMETERS menu to the GENERAL and then move further to the sub-menus TEMP RANGE and FILTER.

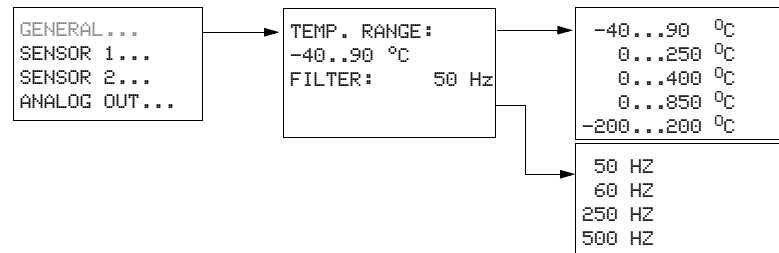

TEMP. RANGE:

Here you define the temperature range that can be measured with the temperature modules and sensors used.

Default settings: -40°C...+90°C

- ▶ In the TEMP RANGE menu, press OK to activate Entry mode and then use the ^ v cursor buttons to set the required temperature range.
- ▶ Complete the setting of the temperature range with OK.
- ▶ Exit the menu as normal by pressing ESC.



The temperature range selected applies to both inputs for temperature measuring!

FILTER:

Factory setting: 50 Hz

This allows you to set the parameters for digital filtering of the A/D converter, irrespective of the set scan time. With this hardware filter, you can eliminate the frequency dependent interference of the analog input values that are present in the measuring environment. In this way, the input values are smoothed.



Ensure that all passive measures for interference suppression, e.g. in the laying of the signal cables are implemented first of all before optimizing the filter frequency, → Section "Connecting analog inputs", page 69.

The attenuation of the hardware filter is particularly high (approx. 100 dB) at the set frequency and at the integral multiples of the frequency. For example, if you have set a filter frequency of 500 Hz, this filter will attenuate especially the high frequency interference in the range around 1000 Hz, 1500 Hz, 2000 Hz etc.

Example:

With low frequency interference from the 50 Hz power supply you should retain the factory set filter frequency of 50 Hz.

The required cycle time of the temperature module depends on the filter frequency selected. This is the time that the temperature module requires to provide the next temperature value for your application.

Table 14: Configurable filter frequencies and resulting cycle time

Filter frequency [Hz]	Max. resulting cycle time of the temperature module [ms]
50 (Default)	350
60	370
250	320
500	160

No general recommendations regarding optimum filter frequency can be given since any possible interference depends on the measuring environment concerned. This must be determined by trial and error in the event of a fault.

- ▶ In the FILTER menu, press OK to activate Entry mode and then use the ^ ∨ cursor buttons to select a filter frequency with better damping.
- ▶ Complete the setting of the filter frequency with OK.

3 Commissioning

3.5 I/O module with temperature measuring

3.5.2.2 Menu SENSOR 1 or 2

This menu is used to parameterize the inputs for temperature measuring.



The setting options described here are the same as for the SENSOR 2 menu.

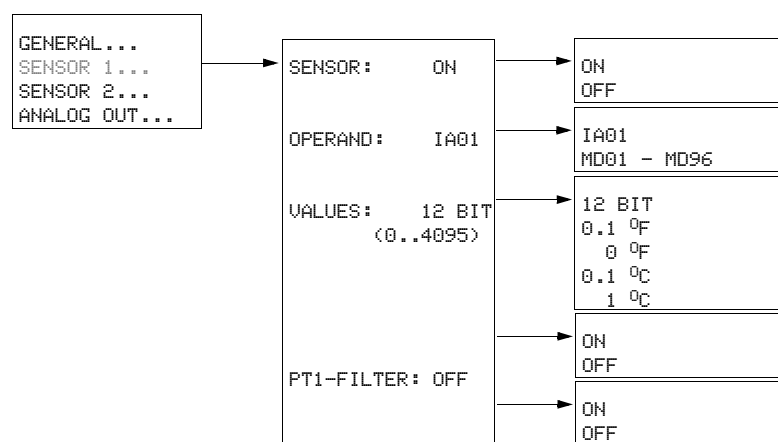

Figure 89: Setting options in the menu SENSOR 1

Choose menu items SENSOR 1 or SENSOR 2

- to deactivate or activate temperature measuring via the relevant sensor and
- to parameterize a scaling of the temperature values of the activated sensor.

The setting has no effect on the other sensor.

SENSOR: (ON/OFF)

Factory setting: ON



The factory setting of a temperature module has both sensors activated. Switch off an input that is not used, otherwise an activated but unconnected input will signal a fault such as a wire break.

- ▶ From the PARAMETERS menu choose menu item SENSOR 1 or SENSOR 2.

In the following menu, the SENSOR menu item is already selected.

- ▶ Press OK to activate Entry mode and then use the ^ v cursor buttons to switch this temperature input on or off.
- ▶ Complete the setting with OK.

The parameter settings described below are possible when the sensor is activated.

OPERAND: (IA01/02 or MD01 - 96)

Factory setting: IA01 or IA02 depending on the sensor, value range 0 - 4095.

With each temperature input you can choose between operand types IA.. and MD...

IA01/02

When assigning via the operands **IA01/02** values are read in the range 0 - 4095, the resolution is approx. 2.44 mV.

MD01 - 96

If you process a temperature input via operands MD01 - 96 you can implement a scaling of the temperature values in five stages (VALUES menu).

The temperature module scales the measured temperature value to the set format and supplies a signed fixed decimal number in the relevant stage.

In the visualization you can thus display the temperature value with the decimal point and decimal places without the need for conversion in the MFD program.



If the input values have to be scaled, you should not implement this in the program but let the temperature module perform this task. Scaling via the program uses up cycle time and memory.

How to process a temperature value via MD01 - 96:

- ▶ Move to the OPERAND menu item via the SENSOR 1 or SENSOR 2 menu and select in Entry mode the operand MD01 or MD02.
- ▶ Close the operand selection with OK.

You can then complete the scaling via the VALUES menu item.

VALUES

Default setting: 12 BIT (0 - 4095).

This menu item is used to scale the temperature value according to the selected temperature range. This allows you to:

- Select between degrees Celsius (°C) or Fahrenheit (°F) and
- vary the resolution between 1° or 0.1° within these two display types.

CAUTION

The scaling also affects the resolution of the read temperature value for further processing in the program. Use a high resolution if possible.

3 Commissioning

3.5 I/O module with temperature measuring

Table 15: Temperature measuring ranges and resulting value ranges with assignment via MD..

Temperature Measurement range	Scaling	Value range (for Visualization)
For all:	12 bits	0 - 4095
-40 - 90 °C	1 °C	-40 - 90
	0.1 °C	-400 - 900
	1 °F	-40 - 194
	0.1 °F	-400 - 1940
0 - 250 °C	1 °C	0 - 250
	0.1 °C	0 - 2500
	1 °F	+32 - 482
	0.1 °F	+320 - 4820
0 - 400 °C	1 °C	0 - 400
	0.1 °C	0 - 4000
	1 °F	+32 - 752
	0.1 °F	+320 - 7520
0 - 850 °C	1 °C	0 - 850
	0.1 °C	0 - 8500
	1 °F	+32 - 1562
	0.1 °F	+320 - 15620
-200 - 200 °C	1 °C	-200 - 200
	0.1 °C	-2000 - 2000
	1 °F	-328 - 392
	0.1 °F	-3280 - 3920

- ▶ Press OK in the VALUES menu to activate Entry mode and then select unit of measure and resolution using the cursor buttons $\wedge \vee$.
- ▶ Complete the scaling with OK.

The line below VALUES shows in round brackets the temperature range according to the set scale. The division of this range by the scaling factor produces the value range that you use for the parameterization in the visualization in the **Value range** area.

Example with selected temperature range -40°C...+90°C:

- From sensor 1 you read a temperature value via the operand MD01 and have selected a resolution of 0.1 °C under VALUES.
- The MFD shows (-40.0...90.0) as the temperature range.
- In the visualization via the numerical value screen element (↔ section "6.4.15 Numerical value", page 400) set:
 - Value range [min] = -400; [max] = 900 (-40.0/0.1 or 90.0/0.1).
 - Scaling Range: -40.0 - 90.0.

PT1-FILTER

Factory setting: OFF

This “software” filter with low pass or PT1 characteristics smoothes the temperature value. This suppresses variations in the temperature sensor values that are caused by high-frequency interference.



However, the hardware filter offers the more effective filtering, see Parameterizing the filter (Hardware) (→ section “ FILTER:”, page 109).

The staggered use of hardware and software filters drastically increases the recovery time. This should not, however, be greater than necessary, otherwise the signals will be delayed more than is required by the smoothing.

SCAN TIME

Factory setting: OFF

When the SCAN TIME is switched off, cyclical temperature measuring is deactivated. The A/D converter converts the analog input value at maximum speed.

However, if cyclical temperature measurement with equidistant scanning is required in conjunction with a DC - PID controller, switch SCAN TIME to ON .

By scanning is meant the recording of continuous analog input signals at specified intervals. The value recorded at a specific time represents the value that needs to be digitalized for the A/D converter.

After cyclical operation is activated, you can set the time interval between the individual scans via the scan time **TA**. The temperature module is factory set to the minimum value (200 ms).

In the example given, the scan time to be set would depend on the scan time T_C of the PID controller.

- ▶ In the SCAN TIME menu item: press OK to activate Entry mode and use the cursor buttons $\wedge \vee$ to switch cyclical measuring on or off.
- ▶ Confirm with OK.

When SCAN TIME is activated, i.e. cyclical measuring, then set the scan time TA.

- ▶ In the new menu item TA: press OK to activate entry mode and use the cursor buttons $\langle \rangle$ to move the numbers to be modified.
- ▶ Use the cursor buttons $\wedge \vee$ to set the value, if necessary, move to the next digit and close the parameter assignment with OK.
- ▶ Exit the SENSOR menu item by pressing ESC.

3 Commissioning

3.5 I/O module with temperature measuring

3.5.2.3 Menu ANALOG OUT

If you wish to output analog values, use a type MFD-TAP13 temperature module. The temperature module outputs a voltage from **0 - 10 V** via the physical analog output QA1. With the fixed 12-bit conversion, the smallest resolution is approx 2.44 mV.

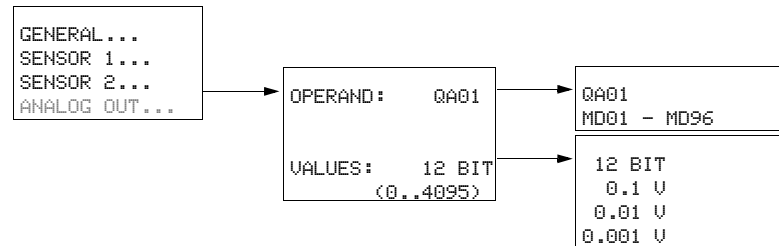

Figure 90: Setting options in the ANALOG OUT menu

OPERAND: (QA01 or MD01- 96)

Default settings: QA01, Value range 0 - 4095.

The analog value to be output can either be assigned to the physical analog output QA1 via the operand QA1 or via MD01 - 96 (marker double word).

QA1

When assigning via the operand **QA1** values are read in the range 0 - 4095, the resolution is approx. 2.44 mV.

MD01 - 96

When assigning the analog output value via an operand **MD01 - 96**, you can scale it in three stages (→ VALUES menu). When the value is output and visualized at the same time, this assignment has the advantage that the temperature module already scales the output value for the required display.

Output an analog output via MD01 - MD96 as follows:

- ▶ Move to the OPERAND menu item via the ANALOG OUT menu and select in Entry mode an operand MD01 - 96.
- ▶ Close the operand selection with OK.

You can then complete the scaling via the VALUES menu item.

VALUES

Default setting: 12 BIT (0 - 4095).

Here select the 12 BIT value or the scaling of the output value in three stages between 0.001 V, 0.01 V or 0.1 V.

CAUTION

The scaling also affects the resolution of the analog output value. Use a high resolution if possible.

Table 16: Analog output values with assignment via MD..

Parameter VALUES (Scaling)	Resolution [mV]	Value range (for Visualization)
12 bits	2.44	0 - 4095
0.1 V	100	0 - 100
0.01 V	10	0 - 1000
0.001 V	2.44 ¹⁾	0 - 10000

1) limited by the 12-bit resolution

- ▶ Press OK in the VALUES menu to activate Entry mode and then use the \wedge \vee buttons to select the scaling factor.
- ▶ Complete the scaling with OK.

The scale-dependent range of the analog output values is shown in brackets in the line below VALUES. The division of this range by the scaling factor produces the value range that you use for the parameterization in the visualization in the **Value range** area.

Example:

- You are outputting an analog value via an MD.. operand and have selected in VALUES a resolution of 0.001 V.
- The MFD shows the range (0.000...10.000).
- In the visualization via the numerical value screen element (→ section "6.4.15 Numerical value", page 400) set:
 - Value range [min] = 0; [max] = 10000 (10.00/0.001)
 - Scaling Range: 0.00 - 10.00

3 Commissioning

3.5 I/O module with temperature measuring

3.5.3 Menu DIAGNOSTICS

The temperature module offers a range of different diagnostics options that are provided separately for each sensor.

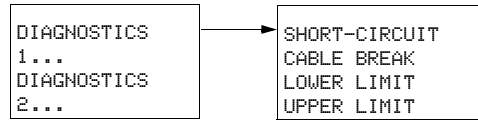

Figure 91: Setting options in the DIAGNOSTICS 1, 2

3.5.3.1 DIAGNOSTICS 1



The setting options described here are the same as for the DIAGNOSTICS 2 menu.

This menu is used to control the temperature input 1. A serious fault is indicated with a tick. Temporary faults are not stored.

SHORT-CIRCUIT

Short-circuit on Sensor 1.

CABLE BREAK ✓

Cable break (wire break) on sensor 1.

LOWER LIMIT

The actual value on sensor 1 is below the set measuring range.

UPPER LIMIT

The actual value on sensor 1 is above the set measuring range.

3.5.4 Menu INFORMATION...

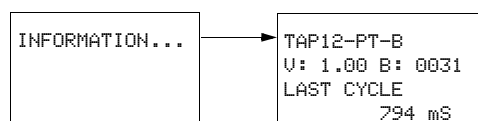

Figure 92: Menu INFORMATION

V:

(Version) operating system version of the temperature module, e.g. 1.00.

B:

(Build), the development level within the version, e.g. 0031.

LAST CYCLE: [ms]

The time which the temperature module required for measuring, converting and possibly filtering and scaling the last measured value, e.g. 393 ms. A filter can considerably increase the cycle time.

When SCAN TIME is deactivated the displayed cycle time is determined by the stated factors.

With cyclical temperature measuring (SCAN TIME = ON), the cycle time is primarily determined by the set scan time TA, → section "SCAN TIME", page 113.

The cycle time output here indicates whether the temperature module can provide the measured value within the SCAN TIME set.

3.5.5 NEW PARAMETERS...!**SAVE:**

This menu appears after a parameter change.

- ▶ Press OK pushbutton to confirm or discard your entries by leaving the menu with CANCEL.

3.6 Configuring the analog expansion unit

The EASY4.-DC-ME expansion units for analog value and temperature measuring must be configured before commissioning. The digital inputs/ outputs of these expansion units are detected by the basic device automatically - without any configuration.

You can carry out the configuration conveniently with easySoft-Pro or via the buttons on the display/HMI unit.

Basic requirements:

- The MFD basic device and the expansion unit are connected via the EASY-LINK-DS plug connector.
- Both devices must be connected to the power supply and mounted.
- The basic device must be in STOP mode and the Status display must be showing.

All analog inputs and outputs of this expansion unit can be activated/ deactivated individually.

They are processed in the program using marker words, → Table 17.

Carry out the parameter and configuration settings for an analog expansion unit in the IO-DEVICE MODE- INPUT XXXX menu:

3 Commissioning

3.6 Configuring the analog expansion unit

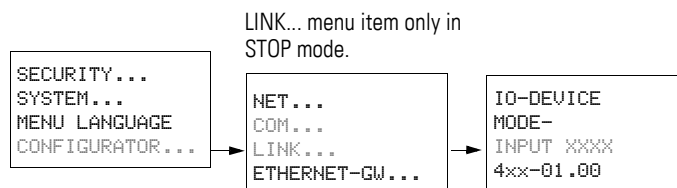

3.6.1 Setting device parameters (IO-DEVICE menu)

On the MFD basic device, access the IO-DEVICE MODE-INPUT menu:

- ▶ Simultaneously press the DEL and ALT buttons with the status display active.
- ▶ Select the CONFIGURATOR menu option and press the OK button.

```
SECURITY...
SYSTEM...
MENU LANGUAGE
CONFIGURATOR...
```



The following steps, starting from the opening of the LINK menu, are only possible in STOP mode.

```
NET..
COM...
LINK...
ETHERNET_GW...
```

- ▶ Now choose the LINK menu item and press the OK button.

The INPUT XXXX (for EASY411-DC-ME) or XXX (for EASY406-DC-ME) menu item is selected and the lowest parameter digit flashes.

```
IO-DEVICE
MODE-
INPUT 3333
4xx-01.00
```

- ▶ Use the <> cursor buttons to select the digit to be changed and then use the ^ v cursor buttons to select the required value (→ Figures 93 and 94 on the following pages).

After you have carried out the necessary parameter settings, confirm with the OK button. The device switches back to the Status display.

Pressing the ESC pushbutton returns you to the Status display without changing the parameters.



If you select invalid device parameters, e.g. 3334 on EASY411-DC-ME, and leave the menu with OK, the device carries out an internal check and then re-opens INPUT XXXX. It proposes the last valid value as the device parameter, which you can now change or confirm with OK.

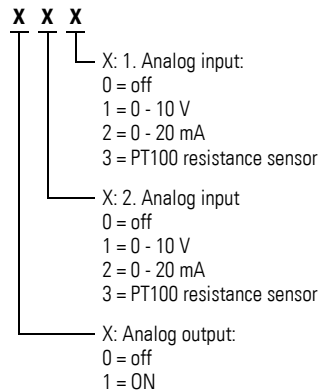

Figure 93: Device parameters EASY406-DC-ME (three-digit)

Factory setting = 111

(analog input 1 and 2 are activated, both for 0 - 10 V as well as the analog output). Marker words MW93 - MW95 are therefore assigned (→ Table 17, page 120).

With EASY406-DC-ME you can activate and commission a voltage, current or temperature input for analog value 1 and 2.

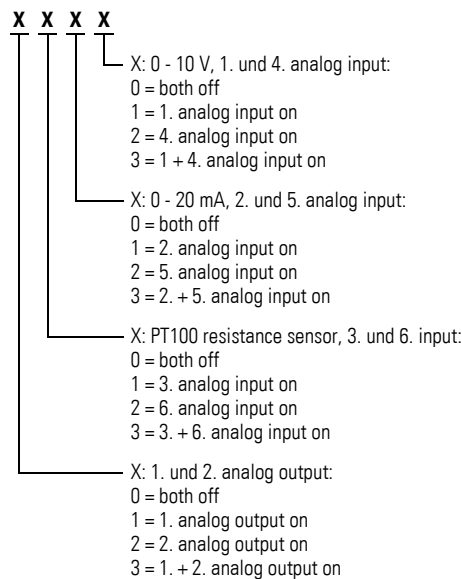

Figure 94: Device parameters EASY411-DC-ME (four-digit number)

Factory setting = 3333

(analog input 1 to 6 are activated, as well as analog output 1 and 2). Marker words MW89 - MW96 are therefore assigned (→ Table 17, page 120).

With EASY411-DC-ME you can activate and commission all six analog inputs (voltage, current or temperature) at the same time.

3 Commissioning

3.6 Configuring the analog expansion unit



The device parameters configured here are stored retentively and exclusively in the expansion device, but not in the basic unit.

Consequence: when replacing a configured expansion device, this configuration must be repeated

3.6.1.1 Temperature measurement

The analog expansion units operate with connected Pt100 sensors in a range between -50 °C and 200 °C.

3.6.2 Processing analog input/output values

You access the configured analog input/output values via marker words (MW). The process image is located in the marker words.

3.6.2.1 Marker assignment with operation on MFD basic devices

Table 17: Marker assignment using analog input/output values

Analog value Input/ Output	EASY406-DC-ME	EASY411-DC-ME
1. Analog input	MW93	MW89
2. Analog input	MW94	MW91
3. Analog input	–	MW93
4. Analog input	–	MW90
5. Analog input	–	MW92
6. Analog input	–	MW94
1. Analog output	MW95	MW95
2. Analog output	–	MW96



A new analog expansion unit is factory set for all inputs/outputs to be activated. All the assigned marker words are thus also taken.

For your expansion unit only configure the analog inputs/outputs that are actually required.

This has several advantages:

- More free marker words for use in the program or in the visualization.
- Only relevant error messages, as otherwise an activated but unconnected input will signal a fault such as a wire breakage.
- Shorter response times due to faster data exchange between basic device and expansion unit.

Example configuration with EASY411-DC-ME

This analog expansion unit is required to read a voltage 0 - 10 V via 1. analog input and a voltage 0 - 10 V via 1. analog output.

→ Resulting parameter setting for expansion unit: 1001

The marker words MW89 (1. analog input) and MW95 (1. analog output) are used for this application.

Example configuration with EASY406-DC-ME

Two analog values are to be monitored for equal voltage.

The voltage at analog input 1 of the expansion device (terminal R2) is required to be compared with a constant and the result "greater/equal" is to be monitored. The "greater/equal" result is to be indicated by the state 1 at output Q1. Analog input 2 and the analog output of the expansion device are deactivated.

→ Resulting parameter setting for expansion unit: 001

```
A 01Q1-----C Q 01
A 01CY-----S Q 02
```

```
A 01 EQ +
>I1 500
>F1 +2
>I2 MW93
>F2 +10
>OS
>HY
```

Parameter setting of the "analog value comparison" function block

3.6.2.2 Wiring digital inputs/outputs

The digital inputs R1 - R3 as well as the digital outputs S1/S2:

- do not have to be activated in the configuration.
- can always be wired in the circuit diagram.
- can be used simultaneously with any configured analog input/output.

Digital inputs R1 - R3

The digital inputs R1 - R3 of the analog expansion inputs are used in exactly the same way as the digital expansion units.

The state of the digital input R1 is evaluated by the hardware. To use the digital inputs R2/R3 you have connected the two analog 0 - 10 V inputs (terminal 2 and 7). Their state is evaluated by the software. The expansion device indicates 0 at R2/R3 if the voltage goes below 8 V DC and 1 if this voltage is exceeded.

Digital outputs S1, S2

The digital outputs S1 and S2 of the analog expansion units are used in exactly the same way as the digital expansion units.

3.6.3 Diagnostics of an analog expansion unit

Table 18: Group fault messages of the analog expansion units

Diagnostics contact	Meaning of group message
Fault on 1 state	(with identical measuring processes, the same fault can be present at two analog inputs or outputs).
R13	Wire break on at least one analog input for measuring 4 - 20 mA current. With current measuring activated the fault message can only appear if a current < 3 mA is present.
R14	Wire break on at least one PT100 input for temperature measuring. The fault message can only appear with PT100 measuring activated.
R15	Short-circuit at analog output 0 - 10 V.
R16	Short-circuit on at least one digital output

3.7 Commissioning NET stations

Requirements for commissioning the NET:

- All stations must be properly connected to the NET (→ Section "2.7 Connecting the easyNET network", page 82), the bus terminating resistors on the physically first and last NET stations must be fitted and the supply voltage must be connected to all NET stations. The POW LED of all NET stations must be lit or flashing.
- Ideally use a device with a display or display and keypad as the first NET station.
- The device to be parameterized must be in STOP mode. The POW LED of this NET station must be permanently lit.

When commissioning for the first time, the NET LED is "Off".



Your NET can only be configured by the station with NET-ID 1 if it has been set up according to the "loop-through" (→ Page 85) topology. In order to simplify the process, you should define all parameters through this NET station with NET-ID 1.

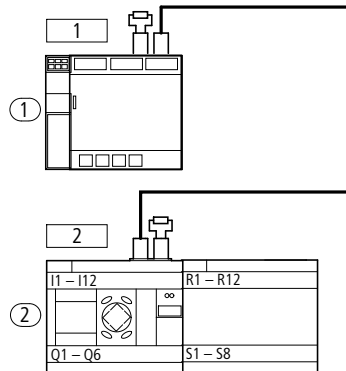

Figure 95: Example topology with two NET stations

① Bus termination resistor

□ physical location ○ station number

3.7.1 NET parameterize

If you wish to work with the non-safety NET and exchange non-safety data with several stations, you must complete the parameterization and configuration for this beforehand.

An introduction to the easyNet network is provided in → section “7.1 Introduction network easyNet”, page 437.

3 Commissioning

3.7 Commissioning NET stations

3.7.1.1 Quick entry

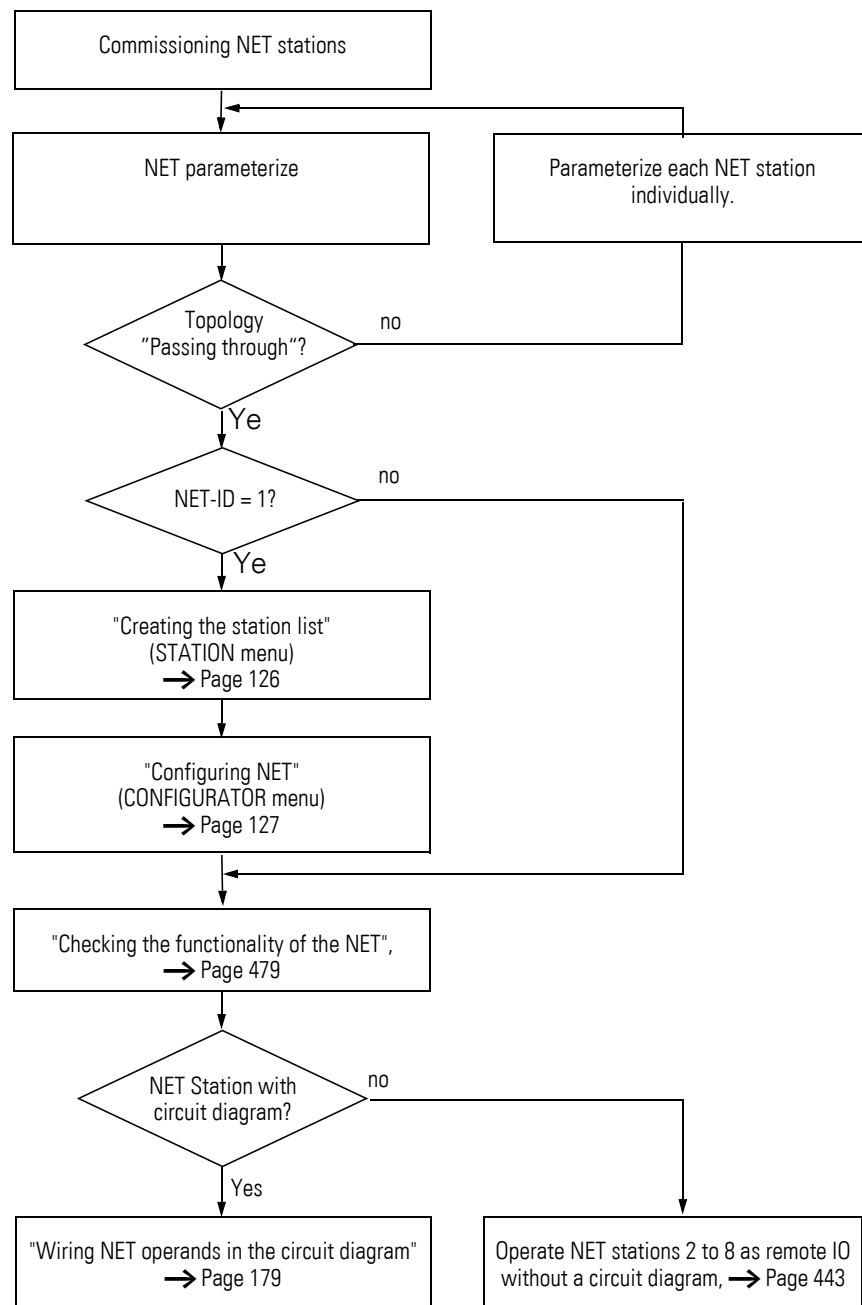

You can assign parameters and complete the configuration conveniently with easySoft-Pro or via the buttons of a device with display. A detailed description of the NET parameters is provided in (→ section “7.2 Description of the NET-PARAMETERS”, page 440).

➔ Start the parameterisation with the physically first device on the NET, the station with NET ID 1. This NET station can be used to configure the entire NET. You should only configure the device locally when you are replacing individual devices.

Parameter setting

Carry out the parameter and configuration settings of a NET station in the NET PARAMETERS menu:

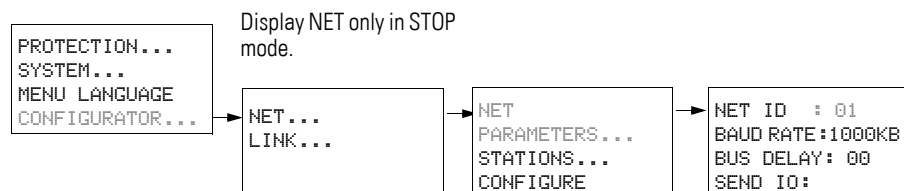

Figure 96: Menu NET PARAMETERS

On the MFD device with a network connection (MFD-...-NT) enter the NET PARAMETERS menu as follows:

- ▶ Simultaneously press the DEL and ALT buttons with the status display active.
- ▶ Select the CONFIGURATOR menu option and press the OK button.

```

SECURITY...
SYSTEM...
MENU LANGUAGE
CONFIGURATOR...
  
```

➔ The following steps, starting from the opening of the NET menu, are only possible in STOP mode.

- ▶ Select the NET menu option and press the OK button.
- ▶ Select the NET PARAMETERS menu option and press the OK button.

```

NET..
COM...
LINK...
ETHERNET_GW...
  
```

```

NET
PARAMETERS...
STATIONS...
CONFIGURE...
  
```

- ▶ Use the ^ and v buttons to assign the NET ID (in this case: NET ID 01) in the NET PARAMETERS menu and confirm the setting with OK.
- ▶ Move to the baud rate and set here the maximum permissible transfer rate that your NET allows (➔ section "11.3.8 NET easynetwork", page 515). This will save you any unnecessary delay times:

```

NET ID : 01 ↑
BAUD RATE:125KB
BUS DELAY: 00
SEND IO      ✓ ↓
REMOTE RUN  ✓
  
```

The remaining parameters are not described further here. They are described in detail (➔ section "7.2 Description of the NET-PARAMETERS", page 440).

3 Commissioning

3.7 Commissioning NET stations

➔ The functions REMOTE RUN and REMOTE IO are not required for the station with NET ID 1 and are therefore not available here.

- ▶ If all settings are ok, press ESC to exit the menu.
As you are currently parameterizing the station with NET ID 1, you can now create the NET station list in the STATION menu, then assign the NET IDs via the CONFIGURATION menu and set a standard baud rate and bus delay time.

3.7.1.2 Creating the station list

You create the station list in the STATION menu.

Only the physically first station with NET ID 1 manages a station list. You can only register other NET stations via this NET station or via easySoft-Pro.

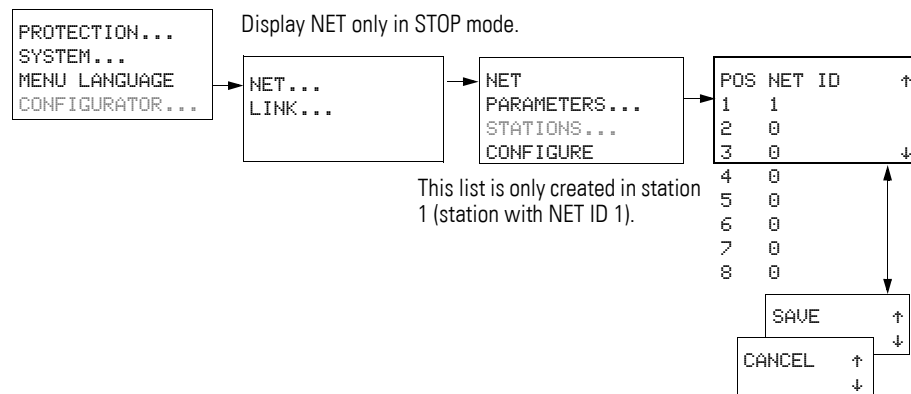
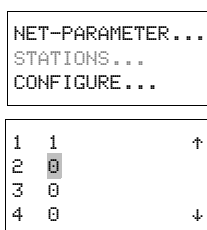

Figure 97: STATION menu



- ▶ Use the ^ and v cursor buttons to select the STATIONS... menu and press the OK button.

- ▶ Proceed to the station with physical address 2.

➔ The left-hand column shows the geographical position of the device on the network. Use the number in the right-hand column to assign a NET ID to the device. Position 1 is always assigned to NET ID 1. You can only assign unused NET IDs.

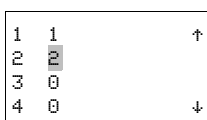

- ▶ Select the required physical location, in this case position 2, with the ^ and v cursor buttons and press OK.
- ▶ Select the NET ID 2 with the ^ and v cursor buttons and confirm your input with the OK button.

At physical location 2, the station has been assigned station address 2.

- ▶ Press ESC to return to the STATIONS menu item.

3.7.2 Configuring NET

Once you have completed the parameter assignment of the NET stations and created a station list, you can then configure the easyNet. Carry out this configuration in the CONFIGURE menu.

You can only configure the NET network by entering settings on the NET station 1.

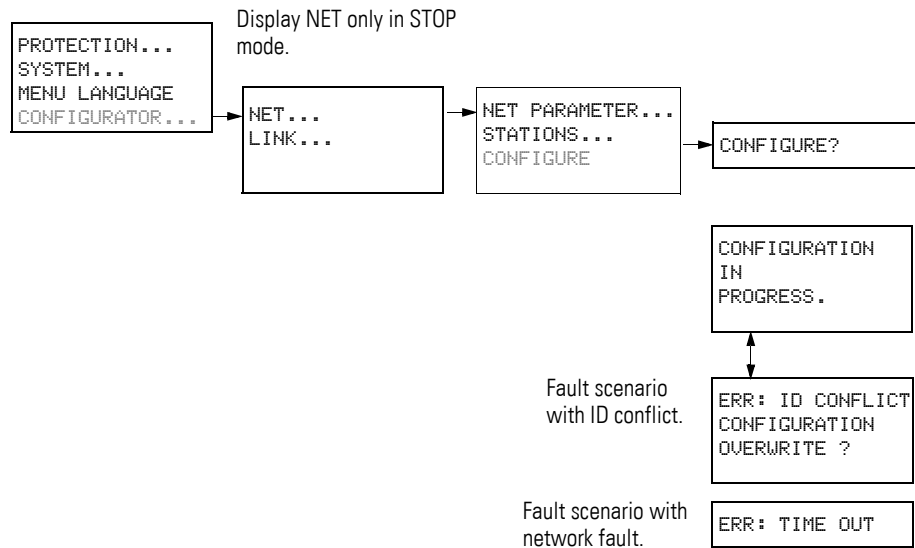

Figure 98: CONFIGURE menu

Requirement for the configuration using NET station 1:

- You must have wired your network as a “loop through” topology.
- All stations must be correctly connected to the NET and the termination resistors must have been connected.
- All stations have voltage, show the basic menu in the device display (the status display) and are in operating mode STOP. The POW and NET LEDs must be permanently lit.

For the configuration, all devices connected on the NET are assigned their NET ID in the order in which they were entered in the station list in the STATION menu. Furthermore, all devices are automatically set with the baud rate and bus delay time set on NET station 1.

3 Commissioning

3.7 Commissioning NET stations

CAUTION

The REMOTE IO, SEND IO and REMOTE RUN parameters required for operation are not transferred to the connected device with the NET configuration.

If you require a parameter setting that is different to the factory setting, you can do this locally via the NET PARAMETERS menu of the NET station concerned. An easier way is to carry out the parameter setting in easySoft-Pro in conjunction with a program transfer to the device concerned.



During the NET configuration, all connected stations switch automatically to the operating state STOP. The NET LED for the stations with NET ID 2-8 switches to OFF.

3.7.2.1 Procedure

```
NET-PARAMETER...  
STATIONS...  
CONFIGURE
```

- ▶ Proceed to the CONFIGURE menu item and press the OK button.

You will be asked to acknowledge whether you want to configure the system.

```
CONFIGURE?
```

- ▶ Press OK.

```
CONFIGURATION  
IN  
PROGRESS.
```

The configuration is successfully completed if the message on the left appears. The NET menu is displayed again and the NET LEDs of all stations flash. The NET is operational.

- ▶ Press the ESC key to exit the menu.



Any errors during the configuration are indicated by messages or via the NET LEDs.

Further information can be found in following section and → section "10.4 Functionality of the NET faulty", page 489.

3.7.2.2 Messages

The following messages may be output during the configuration:

Table 19: Possible messages during the configuration

Message	Meaning
CONFIGURATION IN PROGRESS.	The configuration is error-free, the NET is then operational with the connected stations.
ERR: ID CONFLICT CONFIGURATION CONFIGURATION ?	At least two NET stations have the same NET ID → Section " Error message: ID conflict".
ERR: TIME OUT	Network fault, for example if the cable is not correctly fitted or interrupted. Or you are trying to assign NET ID 1 to a NET station, although a master with NET ID 1 is already present on the NET. Solution: Check the plug connection or the assigned NET IDs and restart the configuration.

Error message: ID conflict

An error message will appear if a station has a NET ID that does not correspond to the physical location in the station list:

```
ERR: ID CONFLICT
CONFIGURATION
OVERWRITE ?
```

If you wish to correct the NET ID (→ Section "3.7.3.2 Changing NET ID and position"), confirm the prompt with OK. Otherwise you can cancel the configuration with ESC.

3.7.3 Changing the NET configuration

The configuration of the NET network can be modified at any time at NET station 1, physical location 1.

3.7.3.1 Changing NET PARAMETERS

- ▶ The NET parameters are modified (→ section "3.7.1 NET parameterize", page 123).

3.7.3.2 Changing NET ID and position

- ▶ Go to the physical location which is to be modified (→ Section "3.7.1.2 Creating the station list" on page 126).
- ▶ Press the OK button.



Existing NET IDs can only be modified to free, non-assigned NET IDs. If all eight numbers are assigned, all NET IDs which are to be modified must be set to zero. After that all NET IDs can be reassigned.

For greater simplicity, the device sets all NET IDs to zero that have a physical location behind the first assigned zero.

3 Commissioning

3.7 Commissioning NET stations

- ▶ Select the required NET ID with the ^ and v cursor buttons and confirm your input with the OK button.
- ▶ Configure NET stations again using the CONFIGURATION menu, → section "3.7.2.1 Procedure", page 128.

CAUTION

Operating the NET with two masters (two stations with NET-ID 1) is not allowed, and leads to malfunctions on the NET.

Possible effects of this type of incorrect configuration with two masters competing against each other, and in which one is operated in the STOP operating mode and the other in the RUN operating mode, are as follows:

NET stations with NET-ID 2 - 8 that should follow the operating mode changes of the NET station with NET-ID 1 automatically during operation (REMOTE RUN parametric programming) keep toggling constantly between the STOP and RUN operating states.

When integrating a master that is already configured into an existing NET, please make sure that there is no other station with NET-ID 1 on the NET.

Also, when performing the configuration from easySoft-Pro and a local connection to a station, please make sure you do not assign NET-ID 1 to this station if there is a master on the NET already.

Tip: Carry out a NET configuration through NET station 1 after every change to the NET.

If your NET configuration does not function as required you will find a description of possible causes in → section "10.4 Functionality of the NET faulty", page 489

3.7.3.3 Deleting the program of a NET station

Selecting DELETE PROGRAM on a configured NET station will also delete its NET ID.

The device concerned is no longer a NET station, indicated by its switched off LED. The NET LED of all other configured NET stations in operation indicates the NET fault with a "permanent light".

CAUTION

If you delete the program in NET station 1, the NET configuration managed by this station is also deleted.

Solution for the accidental deletion of the NET configuration

- With “loop-through” topology
You must create a new NET configuration via the NET station 1 (→ section “3.7.2 Configuring NET”, page 127).
- With “T-piece and spur line” topology.
Locally reassign a NET ID to the device concerned.

3.7.4 Showing the status display of other NET stations

On each device with a program and a display with operating buttons, you display the status of the inputs and outputs of every other NET station.

- ▶ For this change to the status display and press the ESC button.

```
1I12.....
      NT1
MO 06:42
1Q1..... RUN
```

The cursor switches to the display of NET station NT1 and flashes. The NET ID precedes the display of the input/output ID (e.g. 1I..).

```
3I12.....7....
      NT3
MO 06:42
3Q1.3..6.. RUN
```

- ▶ Change the number of the required NET station with the ^ and v cursor buttons.

The input/output states of this NET station are shown in the display (e.g. 3I../3Q..).

```
3R12.....7....
      NT3
MO 06:45
3S1.3..6.. RUN
```

- ▶ Press the ALT button several times if you wish to see the locally set time, the date or the group fault alarms for transistor outputs on this NET station.

Pressing the ESC button further will terminate the display of the input and output states of this NET station and will activate the local display of NET station NT1.



The NET station that shows the status on its display, cannot read out its own data from the NET (see the following example).

Example:

You are viewing the display of NET station NT3, and NT3 is flashing in the display. The inputs and outputs 3I.., 3R.., 3Q.. and 3S.. cannot be displayed.

After you have switched to the local display by pressing ESC, the NT3 display is no longer flashing and the states of the local inputs and outputs are displayed.

3.8 COM-LINK connection

3.8.1 General information on COM-LINK

COM-LINK is a connection between an MFD and an easy800, easySafety or another MFD device. This connection is called a "COM connection" in easySoft-Pro. It requires one active station which can only be an MFD and one passive remote station.

The active station controls the data exchange of COM-LINK operands with the remote station. This responds only to the requests of the active station. The active station can

- read the status of the inputs/outputs on the remote station.
- read or write the marker range MD01 - MD20 on the remote station.

This data can be used in the active MFD for setpoint definition or display functions.



Time-critical processes should not be controlled using this connection.

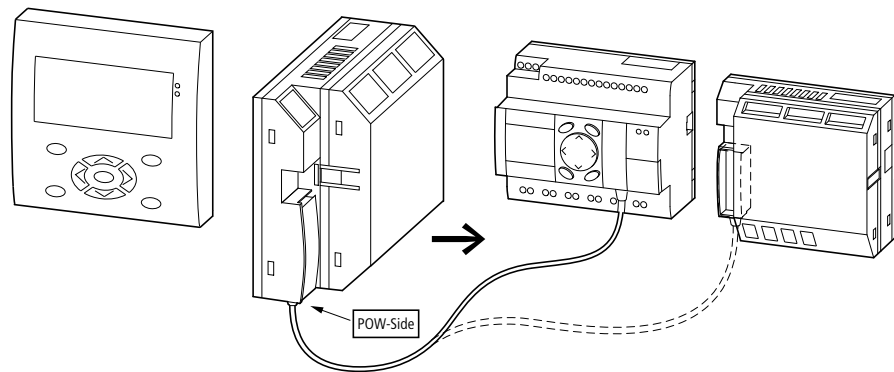

Figure 99: COM-LINK connection to an easy800, easySafety or another MFD

If you connect two MFD devices with each other, **only one device must be the active station**, i.e. COM-LINK must only be activated once in the COM menu.

An MFD operating as an **active** station in the COM-LINK network cannot be an easyNet station at the same time. A **passive** station on the COM-LINK can however also be an easyNet station at the same time. If an MFD station is run as an easyNet station, it can therefore only be used as a passive remote station.



WARNING

If the MFD station is on the easyNet and you switch on the COM-LINK during operation, the easyNet network is deactivated. No further data is exchanged.

Remedy:

- ▶ Deactivate the COM-LINK connection.
- ▶ Reenter the station address.
- ▶ Switch the power supply off and then on again.
- ▶ Configure the easyNet.

3.8.2 Configuring the interface for COM-LINK

The physical interface for the COM-LINK connection is the serial multi-function interface. To activate the COM-LINK connection, the following settings must be known to the active station:

- Baud Rate
 - COM-LINK (active)
 - Remote marker range (data exchange range).
- ▶ Connect both devices using an MFD-800-CAB5 cable.

Only use the original connecting cable. The connector marked "POW-Side" must be plugged into an MFD which supplies the interface circuit in the connecting cable.

- ▶ Connect the power supply to both stations and switch it on.

To operate the COM-LINK connection, only the interface and the marker range of the access data have to be parameterized on the active device. To configure the interface, select the baud rate and activate the COM-LINK connection. This can be carried out via the display/keypad of the MFD.



The following steps are only possible in STOP mode.

3.8.2.1 Baud rate adjustment

- ▶ Simultaneously press the DEL and ALT buttons with the Status display active.

```
SECURITY...  
SYSTEM...  
MENU LANGUAGE  
CONFIGURATOR...
```

The System menu appears.

```
NET..  
COM..  
LINK..  
ETHERNET-GW...
```

- ▶ Choose the CONFIGURATOR menu item and press the OK button.

- ▶ Choose the COM menu item and press the OK button.

```
BAUDRATE: 9600B  
COM-LINK  
REMOTE MARKER..
```

The menu BAUDRATE: 9600B will appear. The two baud rates are for 9600 or 19200 baud.

- ▶ Select 19200 baud and confirm with OK.

```
BAUD RATE: 19200  
B  
COM-LINK  
REMOTE MARKER..
```



If faults occur, change the baud rate to 9600. Check the connection cable. The routing of the cable can help to rectify the faults.

3.8.2.2 activate COM-LINK



The COM-LINK connection must only be activated on the active station.

```
BAUD RATE:  
19200 B  
COM-LINK ✓  
REMOTE MARKER..
```

- ▶ Press the \vee pushbutton.
- ▶ Press the OK button.

The tick on the COM-LINK menu item indicates that the connection is activated.

3.8.2.3 Remote Specifying the marker range

```
BAUD RATE:
19200 B
COM-LINK ✓
REMOTE MARKER..
```

- ▶ Select the REMOTE MARKER menu item.

The following selection is displayed only if COM-LINK is activated.

```
READ:
1M000 → 1M000
WRITE:
1M000 → 1M000
```

- ▶ Press the OK button.

The display indicates the READ and WRITE range with default markers (double words).

```
READ:
1M011 → 1M014
WRITE:
1M000 ↻ 1M000
```

- ▶ Press the OK button.
- ▶ Use the ^ pushbutton to select the beginning of the READ marker range.
- ▶ Use the > pushbutton to enter the upper limit of the READ range.
- ▶ Use the ^ pushbutton to select the value.
- ▶ Confirm the entry with the OK pushbutton.

```
READ:
1M011 → 1M014
WRITE:
1M000 → 1M000
```

- ▶ Use the v button to enter the WRITE range.
- ▶ Enter the WRITE range.

```
READ:
1M011 → 1M014
WRITE:
1M015 → 1M017
```

- ▶ Press ESC pushbutton to leave the entry menu.

```
BAUD RATE:
19200 B
COM-LINK ✓
REMOTE MARKER..
```

- ▶ Press ESC to return to the Status display.

```
I 12.4.67.....
 I COM
 P-
 FR 02:02 ST
```

The entry in the second COM line indicates that the COM-LINK connection is active.

The COM-LINK has now been set.



The COM-LINK connection must not be configured on the remote station.

Wiring COM-LINK operands in the circuit diagram, → section "4.8 Wiring COM-LINK operands in the circuit diagram", page 184.

Monitoring the COM-LINK connection → section "9.6 Monitoring the COM-LINK connection", page 483

3 Commissioning

3.9 Running MFD in Terminal mode

3.9 Running MFD in Terminal mode

An MFD in Terminal mode allows you to remotely operate, i.e. read and control, other devices, such as easy500/700 and easy800 control relays, MFD or ES4P.. safety control relays.



A terminal connection can be set up to an easy800 device with device version number 04 or higher.

Once this controlling MFD has established a connection to the target station, the display of this station is transferred and continuously refreshed. If the target station is a device without a display, e.g. EASY8... X, the actual data and states are shown in a simulated display on the controlling MFD.

You can carry out the same functions on the keypad of the controlling MFD as on the keypad of the local target station.

This application mode for a permanent remote display device is particularly useful for operating devices that do not have a display or which are difficult to access, which do not allow direct operation in the field.

You can set the MFD to switch to TERMINAL MODE on power up and establish a connection to the defined station. → Section "8.2.4 TERMINAL MODE startup (TERMINAL MODE menu item)".

You connect the controlling MFD in two ways:

- via the multi-function interface in a point-to-point connection to a single device.
- as a NET station via the easyNet (NET) to another NET station.

The controlling MFD does not require a program for Terminal mode, but can run a program after switching from TERMINAL MODE to RUN mode.

Table 20: Meaning of the front LED display of the MFD in Terminal mode

LED	Health	Meaning
Red	Off	Fault-free NET operation
Red	continuous light	The remotely controlled device is NET station and its network connection is interrupted, or the NET configuration was changed, but not yet transferred to the device network.
Green	Off	The remotely controlled device is without a power supply. The local display indicates that the connection has broken.
Green	continuous light	The remotely controlled device is in STOP mode.
Green	Flashing	The remote device is in RUN mode.

3.9.1 MFD as a station of a point-to-point connection

Set up a terminal connection to the single device via the point-to-point connection.

The following description shows the example of a point-to-point connection to an easy800.

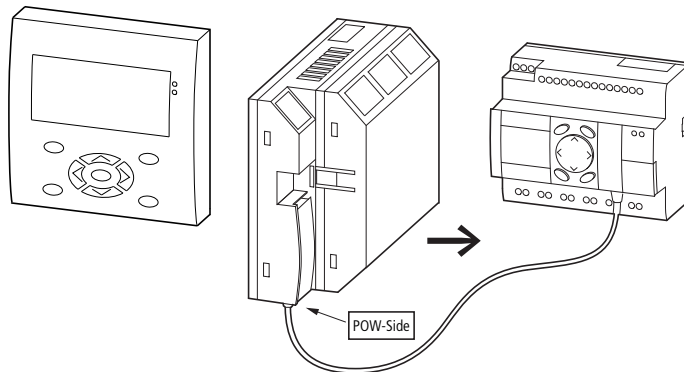

Figure 100: MFD - easy800 connection

Requirements for connection:

- The COM-LINK connection on the MFD must be inactive.
- The controlling MFD is in **STOP** mode.
- Both devices must be connected via the MFD-800-CAB5 cable.



Ensure that the plug marked POW-Side is fitted in the multi-function interface of the active (controlling) MFD. The serial interface only functions if the MFD supplies the required power supply of the connection cable.

Switch the MFD to Terminal mode in the following way:

- ▶ Press OK to move from the Status display to the main menu.
- ▶ Select the TERMINAL MODE and confirm the selection with OK.
- ▶ For a point-to-point connection choose 0 as STATION ID.
- ▶ Choose the START MODE menu item and press the OK button.

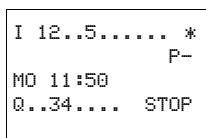

The MFD display now shows the content of the easy800 display. To indicate that the MFD is in Terminal mode the star * flashes in the top right corner of the Status display.

Pressing the Mode pushbutton (*) on the controlling MFD returns you back to its local Status display.



Access in Terminal mode to easySafety devices is possible via a point-to-point connection. Access via the NET is not permissible and therefore inhibited.

3 Commissioning

3.9 Running MFD in Terminal mode

3.9.2 MFD as NET station

If the controlling MFD is a NET station itself, you can establish a direct Terminal connection in succession to every other NET station.

CAUTION

Both MFD devices must not access the same NET station, e.g. the device with ID =4, at the same time. Simultaneous access via the NET by MFD in Terminal mode and the PC (programming device) to a NET station is also not possible and will cause a malfunction on the NET.

If you use an MFD device from device version number 05 you can also set up an indirect terminal connection (→ Figure 103, page 139).

3.9.2.1 Direct connection

The controlling MFD is itself a NET station. Simultaneous operation of several logical terminal connections between two NET stations is possible.

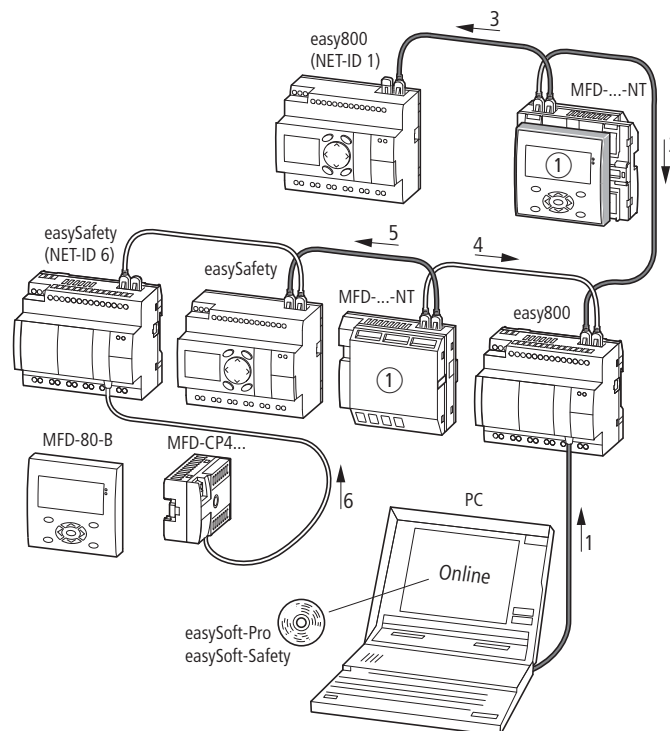

Figure 101: Access options in terminal mode

① Terminal Mode

logical connection	Access permitted/not permitted	Explanation
1 + 2, 1 + 4	Not permissible	Simultaneous access to a NET station from 2 sides
2 + 3	Not possible	In terminal mode, the display/operator system establishes only one logical connection at a time
5	Not permissible	Terminal mode via the NET to easySafety
1 + 3, 3 + 4	Permissible	Simultaneous operation of several terminal connections to different stations
6	Permissible	Local terminal operation to a device that is also a NET station
1, 2, 3, 4	Permissible	Local terminal operation to one device in each case

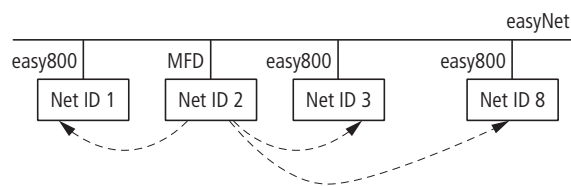

Figure 102: Terminal connection to a different NET station

- ▶ Select the TERMINAL MODE and confirm the selection with OK.
- ▶ As STATION ID select the NET-ID of the required station.
- ▶ Start the terminal mode as described.

3.9.2.2 Indirect connection

The controlling MFD is connected via the multi-function interface with a NET station serving as a base station. In Terminal mode you can select another NET station (target station) via the base station and also check or change its status.

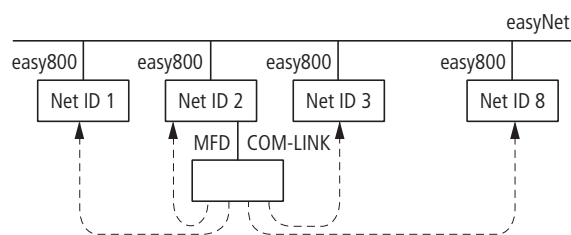

Figure 103: Indirect Terminal connection

Requirements for connection:

- The COM-LINK connection on the MFD must be inactive.
- The controlling MFD must be in STOP operating mode and both devices must be connected via the MFD-800-CAB5 cable.
- ▶ Select the TERMINAL MODE and confirm the selection with OK.
- ▶ As STATION ID select the NET-ID of the required station.
- ▶ Start the terminal mode as described.

3.9.2.3 Example 1: MFD as a NET station

The controlling MFD can be used at any location on the NET. The Terminal mode functions independently of the location and NET ID (1 - 8) of the device.

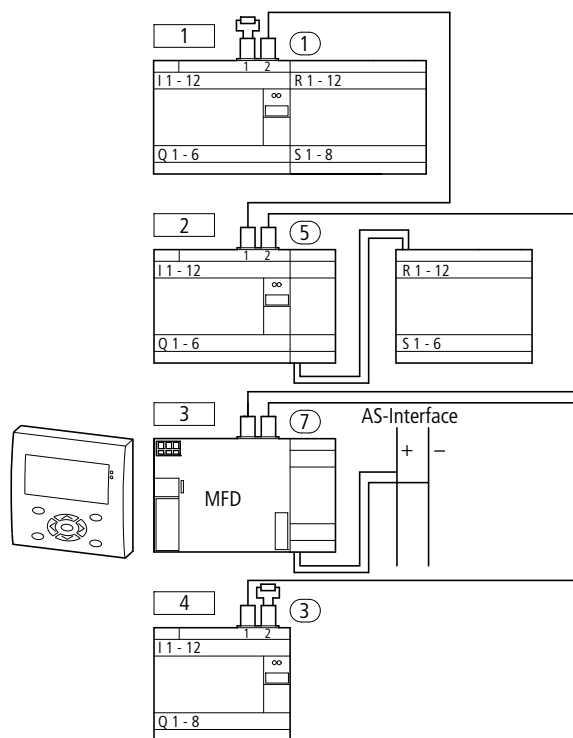

Figure 104: MFD on easyNET



In this configuration, an MFD cannot access a safety control relay on the network.

Establishing a connection to NET stations 1...8

Requirement for connection:

- The COM-LINK connection is not active.
- The controlling MFD is not in the STOP state.

Procedure:

- ▶ Press the OK pushbutton from the Status Display. The menu appears.
- ▶ Press the \wedge pushbutton.

```
PROGRAM...  ↑
STOP        ✓
RUN PARAMETER
SET CLOCK...
```

The TERMINAL MODE menu item flashes.

- ▶ Press the OK button.

```
PARAMETER  ↑
SET CLOCK
INFORMATION...
TERMINAL MODE...
```



```
STATION ID:0
START MODE
```

The START MODE text flashes.

- ▶ Press the **I** button.

```
STATION ID: 0
START MODE
```

The station ID (default value = 0) flashes.



Station ID:

0 = Default setting, point-to-point connection

1 = station 1 on the easyNET

2 = station 2 on the easyNET

...

8 = station 8 on easyNET

```
STATION ID: 0
START MODE
```

- ▶ Press the **OK** button.

```
STATION ID: 5
START MODE
```

- ▶ Select the NET-ID of the station, e.g. 5:
- ▶ Press the **^** or **v** pushbutton.
- ▶ Press the **OK** pushbutton.

```
STATION ID: 5
START MODE
```

- ▶ Choose the START MODE menu:
- ▶ Press the **v** pushbutton.
- ▶ Press the **OK** button.

The MFD tries to establish connection to the selected device. The START MODE text flashes.

```
Connection
establishment
in progress...
```

If the connection is established, the menu or the Status display of the selected device appears.

```
I 1..4..789...
*
I NT5 P-
```

The easyNET station 5 controls the display of the MFD device.



The flashing star at the top right of the Status display indicates that Terminal mode is active.

Close Terminal mode

Press the ***** pushbutton. The MFD menu appears again for activating the Terminal mode.

Message: No connection



If the text "Connection establishment in progress..." is displayed for longer than 10 s, the connection to the selected device is faulty. Press ESC to cancel the selection. Rectify the fault. Try to re-establish the connection

Message: The remote device is in Graphic mode

The remote device is in Graphic mode

The MFD allows a connection (Terminal mode) to be established to a target station that is also an MFD. If the target station is showing a screen in RUN mode, the controlling MFD outputs the message "Device is in Graphic mode" during connection setup.

- ▶ Pressing ALT and ESC together initiates a change to the Status display, provided that the "Disable switch to Status display" button element is not activated.



The controlling MFD can show the status display of the target station. A screen of the target station is not shown!



WARNING

The target station connected to the MFD can be installed in an inaccessible location. Terminal mode gives you all the access rights that you would also be given "locally". Check the controlled system when you carry out a mode change and device settings.

A station with a display and keypad can be operated both locally and from an external MFD. The local operation on the device is always faster than the remote operation in Terminal mode. A simultaneous input must always be avoided as this may cause malfunctions.

3.9.2.4 Example 2: Multiple MFDs as NET stations

Figure105 includes two MFDs that are incorporated as NET stations. In Terminal mode both can access other NET stations. While the MFD (NET ID 1) accesses the device with NET ID 2, the MFD (NET ID 3) can access the device with NET ID 4 at the same time.

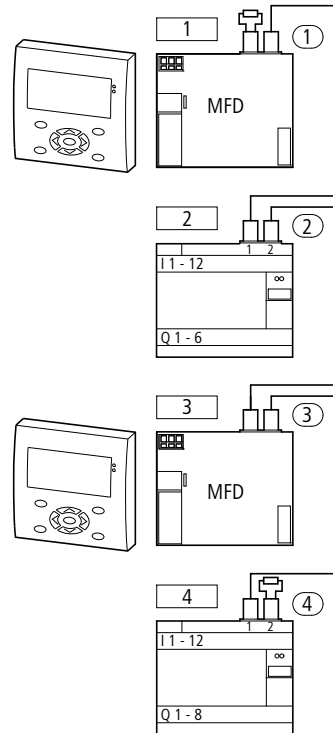

Figure 105: Two MFDs in the NET

3.9.2.5 Example 3: MFD in the NET (indirect connection)

Figure 103 on page 139 shows an MFD connected via the serial multi-function interface to a NET station (base station). After Terminal mode is activated, you can select another NET station (target station) and check its status and states.

Requirements for connection:

- The COM-LINK connection on the MFD must not be active!
- The MFD must not be a NET station (configure separately)!
- The MFD must be in the STOP state.
- Both devices must be connected via the MFD-800-CAB5 cable.

Switch the MFD to Terminal mode:

- ▶ From this display menu select the TERMINAL MODE and confirm with OK.
- ▶ Select a STATION ID 1 to 8.
- ▶ Select the START MODE and press OK.

The MFD display shows for example the display content of an easy800.

Press the * pushbutton to return back to the menu.

3 Commissioning

3.9 Running MFD in Terminal mode

3.9.2.6 Example 4: Multiple MFDs in the network (indirect and direct connection)

In this example, two MFDs are connected indirectly with stations of the network, and one MFD is integrated directly in the easyNet.

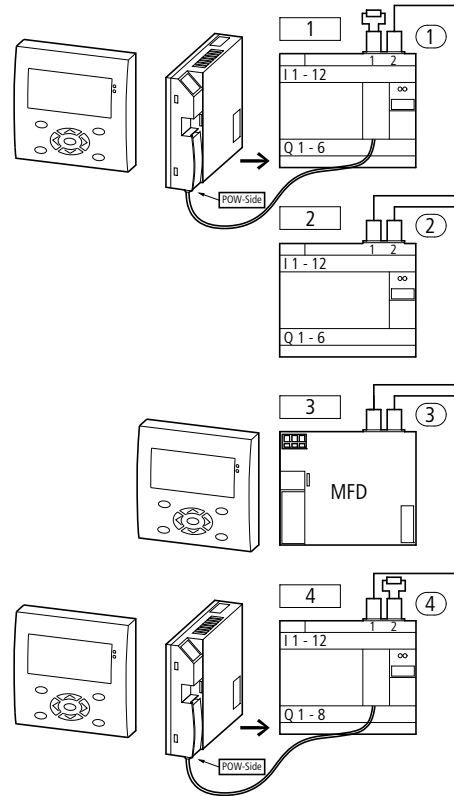

Figure 106: MFD devices with easyNet stations are connected directly and indirectly









An MFD device cannot access a station, e.g. the device with ID =2 if another MFD has already established a direct or indirect connection to this station. Simultaneous access by MFD in Terminal mode and PC (programming device) to a station is also not possible.

4 Wiring with MFD

This chapter describes the entire range of functions of an MFD device.

4.1 MFD operation

4.1.1 Pushbutton for editing circuit diagrams and function blocks

	Delete rung, contact, relay or empty rung in the circuit diagram	[P7]
	Toggle between N/O and N/C contact Connect contacts, relays and rungs Add rungs	[P8]
	^v Change value Move cursor up/down <> Change place Cursor left/right	
	Cursor buttons set as P pushbuttons:	
	< Input P1, ^ Input P2	
	> Input P3, v Input P4	
	Undo setting from last OK Leave current display, menu	[P6]
	Change, add new contact/relay, Save setting	[P5]
	Toggle for Terminal mode	[P9]

P buttons in square brackets [P..] are only available on the MFD-CP10...

4.1.2 Operation

The cursor buttons in the MFD circuit diagram have three functions:

- Moving.
- Input.
- Connecting.

The current mode is indicated by the appearance of the flashing cursor.



In "Move" mode use the ^v<> buttons to position the cursor on the circuit diagram in order to select a rung, a contact, a relay coil or the selection position of a coil function or a NET-ID.

I 01

Use OK to switch to Entry mode so that you can enter or change a value at the current cursor position. Press ESC in Entry mode to restore MFD to the last changes of an entry.

4 Wiring with MFD

4.2 Circuit diagram elements

 Press ALT to switch to Connect mode for wiring contacts and relays. Press ALT again to return to Move.

Press ESC to exit the circuit diagram and parameter display.



The MFD device performs a large part of this cursor change automatically. For example it switches the cursor to Move mode when it is no longer possible to make an entry or connection at the selected cursor position.

4.2 Circuit diagram elements

4.2.1 Program

A program is a series of commands that the MFD device processes cyclically in RUN operating mode.

A MFD program consists of the necessary settings for the device, easyNet, COM-LINK, password, system settings, a circuit diagram, function blocks and/or visualization screens.

The circuit diagram is the part of the program in which the contacts and coils are connected together. In RUN mode, a coil is switched on or off depending on the power flow and coil function set.

4.2.2 Function blocks

Function blocks are program blocks with special functions. Examples: Timing relays, time switch, data block comparators. Function blocks are provided with or without contacts and coils. How a safety or standard function block is added to the safety or standard circuit diagram and parameterized is described in  section "4.9 Working with function blocks", page 188 on.

In RUN mode the function blocks are processed according to the circuit diagram and the results are updated accordingly.

Examples:

Timing relay = Function block with contacts and coils

Time switch = Function block with contacts

4.2.3 Visualization screens

Visualization screens are parts of the program that contain display and operating functions for the application.

4.2.4 Relays

Relays are switching devices that are emulated in MFD device electronically, which activate their contacts according to the assigned function. A relay consists of at least one coil and contact.



4.2.5 Contacts and coils of the circuit diagram

4.2.5.1 Contacts

Contacts are used to change the power flow inside the MFD circuit diagram. Contacts such as N/O contacts are set to 1 when they are closed and 0 when they are opened. In the MFD circuit diagram you can wire contacts as N/O or N/C contacts. N/C contacts are indicated with a horizontal line above the operand concerned.

An MFD device operates with different contacts that you arrange in any order in the contact fields of the circuit diagram.

Table 21: Usable contacts

Contact	MFD representation
 N/O contact, open in release position	I, Q, M, A, ...
 N/C contact, closed in release position	\bar{I} , \bar{Q} , \bar{M} , \bar{A} , ...

A detailed list of all contacts used in the circuit diagram is provided on page 520.

4.2.5.2 Coils

Coils are the actuating mechanisms of relays. The results of the wiring are transferred to the coils when the device is in RUN mode. These switch to the On (1) or Off (0) state according to these results. Coils can have seven different coil functions, → Table 27, page 174.

A MFD device is provided with different types of relays and function blocks which can be wired in a circuit diagram via their coils (inputs).

The switching of the relays is set by means of coil functions and parameters.



All coils in the circuit diagram have the "contactor" coil function!

The options for setting output and marker relays are listed with the description of each coil function.

The coil functions and parameters for the function blocks are explained with the description of each function block.

4 Wiring with MFD

4.2 Circuit diagram elements

The following table shows a list of all contacts and coils useable in the standard circuit diagram.

Table 22: Overview of contacts and coils

Contact	Coil (* = NET-ID 1-8)	Contact N/O - N/C (* = NET-ID 1-8)	Number	Page
Inputs				
Inputs (basic device) I..	-	I/ \bar{I}	01-12	165
Inputs I.. (basic device) of other stations via NET	-	*I/* \bar{I}	01-12	179
Inputs (basic device) of remote station, via COM-LINK	-	1I/1 \bar{I}	01-12	184
Cursor buttons	-	P/ \bar{P}	01-04	172
Inputs (expansion)	-	R/ \bar{R}	01-12	165
Inputs (standard expansion) of other stations via NET	-	*R/* \bar{R}	01-12	179
Inputs (standard expansion) of remote station, via COM-LINK	-	1R/1 \bar{R}	01-12	184
Bit inputs via NET	-	*RN/* $\bar{R}\bar{N}$	01-32	179
Diagnostics inputs				
Status of expansion of other station via NET	-	*I/* \bar{I}	14	481
Short-circuit/overload on other station via NET	-	*I/* \bar{I}	15-16	479
Status (expansion) of remote station, via COM-LINK	-	1I/1 \bar{I}	14	186
Short-circuit/overload of other remote station via COM-LINK	-	1I/1 \bar{I}	15-16	186
Short-circuit/overload on a expansion unit with transistor output	-	R/ \bar{R}	15-16	479
Short-circuit/overload on a expansion unit other NET stations	-	*R/* \bar{R}	15-16	479
Short-circuit/overload with standard expansion of the remote station, via COM-LINK	-	1R/1 \bar{R}	15-16	186
Diagnostics messages	-	ID/ $\bar{I}\bar{D}$	01-32	479
Diagnostics messages of remote station, via COM-LINK	-	1ID/1 $\bar{I}\bar{D}$	01-16	186
Outputs				
Backlight of the MFD display	LE	-	01	420
	-	LE/ $\bar{L}\bar{E}$		
Red LED of MFD display	LE	-	02	23
	-	LE/ $\bar{L}\bar{E}$		
Green LED of MFD display	LE	-	03	23
	-	LE/ $\bar{L}\bar{E}$		
Q outputs.. (basic device)	q	-	01-08	165
	-	Q/ \bar{Q}		
Outputs (Expansion)	S	-	01-08	165
	-	S/ \bar{S}		
Q outputs.. (basic device) of other NET stations	*Q	-	01-08	179
	-	*Q/* \bar{Q}		
Outputs (expansion) of other NET stations	*S	-	01-08	179
	-	*S/* \bar{S}		

Contact	Coil (* = NET-ID 1-8)	Contact N/O - N/C (* = NET-ID 1-8)	Number	Page
Output of remote station, via COM-LINK	1Q	-	01-08	186
	-	1Q/1Q̄		
Output (expansion) of remote station, via COM-LINK	1S	-	01-08	186
	-	1S/1S̄		
Bit outputs via NET	*SN	-	01-32	179
	-	*SN/*SN̄		
Other coils and contacts				
Markers	M	-	01-96	153
	-	M/M̄		
Auxiliary relay (marker or REMOTE MARKER) of remote station, via COM-LINK	1M	-	01-96	154
	-	1M/1M̄		
Jump label	:	-	01-32	325
	-	:		
Function Blocks				
Analog value comparator				199
Value overflow (carry)	-	A X CY/Ā X CY	X = 01-32	
Condition fulfilled		A X Q1/Ā X Q1		
Arithmetic				204
Value overflow (carry)	-	AR X CY/ĀR X CY	X = 01-32	
Value zero		AR X ZE/ĀR X ZE		
Data block comparator				208
Enable	BC X EN	-	X = 01-32	
Failure: number of elements exceeded	-	BC X E1/BC̄ X E1		
Failure: range overlap		BC X E2/BC̄ X E2		
Failure: invalid offset		BC X E3/BC̄ X E3		
Comparison result		BC X EQ/BC̄ X EQ		
Data block transfer				216
Activate (trigger)	BT X T _L	-	X = 01-32	
Failure: number of elements exceeded	-	BT X E1/BT̄ X E1		
Failure: range overlap		BT X E2/BT̄ X E2		
Failure: invalid offset		BT X E3/BT̄ X E3		
Boolean operation				228
Value zero	-	BV X ZE/BV̄ X ZE	X = 01-32	
Counter				232

4 Wiring with MFD

4.2 Circuit diagram elements

Contact	Coil (* = NET-ID 1-8)	Contact N/O - N/C (* = NET-ID 1-8)	Number	Page
Count input	C X C _L	-	X = 01-32	
Direction	C X D _L			
Reset count value	C X RE			
Set counter value (preset)	C X SE			
Actual value has exceeded counter range (carry)	-	C X CY/ \bar{C} X CY		
Lower setpoint value undershot (Fall below)		C X FB/ \bar{C} X FB		
Upper setpoint value exceeded (overflow)		C X OF/ \bar{C} X OF		
Actual value equal to zero		C X ZE/ \bar{C} X ZE		
Frequency Counter				238
Enable counter	CF X EN	-	X = 01-04	
Lower setpoint value undershot (Fall below)	-	CF X FB/ \bar{C} X FB		
Upper setpoint value exceeded (overflow)		CF X OF/ \bar{C} X OF		
Actual value equal to zero		CF X ZE/ \bar{C} X ZE		
High-speed counters				243
Direction	CH X D _L	-	X = 01-04	
Enable counter	CH X EN			
Reset count value	CH X RE			
Set counter value (Preset)	CH X SE			
Actual value has exceeded counter range (carry)	-	CH X CY/ \bar{C} X CY		
Lower setpoint value undershot (Fall below)		CH X FB/ \bar{C} X FB		
Upper setpoint value exceeded (overflow)		CH X OF/ \bar{C} X OF		
Actual value equal to zero		CH X ZE/ \bar{C} X ZE		
Incremental Encoder				249
Enable counter	CI X EN	-	X = 01-02	
Reset count value	CI X RE			
Set counter value (Preset)	CI X SE			
Actual value has exceeded counter range (carry)	-	CI X CY/ \bar{C} X CY		
Lower setpoint value undershot (Fall below)		CI X FB/ \bar{C} X FB		
Upper setpoint value exceeded (overflow)		CI X OF/ \bar{C} X OF		
Actual value equal to zero		CI X ZE/ \bar{C} X ZE		
Comparison, for variables / constants				255
Equal to	-	CP X EQ/ \bar{C} X EQ	X = 01-32	
Greater than		CP X GT/ \bar{C} X GT		
Less than		CP X LT/ \bar{C} X LT		
Data Function Block				258
Transfer 32-bit value (trigger)	DB X T _L	-	X = 01-32	
Block is active	-	DB X Q1/ \bar{D} X Q1		
PID Controller				261

4 Wiring with MFD

4.2 Circuit diagram elements

Contact	Coil (* = NET-ID 1-8)	Contact N/O - N/C (* = NET-ID 1-8)	Number	Page
Activate D component	DC X ED	-	X = 01-32	
Activate I component	DC X EI			
Enable	DC X EN			
Activate P component	DC X EP			
Accept manual manipulated variable	DC X SE			
Value range manipulated variable exceeded	-	DC X LI/ \overline{DC} X LI		
Signal smoothing filter				268
Enable	FT X EN	-	X = 01-32	
Get value from NET (GET)				273
New transferred value present	-	GT X Q1/ \overline{GT} X Q1	X = 01-32	
Weekly timer				276
Switch on condition fulfilled	-	HW X Q1/ \overline{HW} X Q1	X = 01-32	
Year time switch				282
Switch on condition fulfilled	-	HY X Q1/ \overline{HY} X Q1	X = 01-32	
Conditional Jump				291
Enable	JC X EN	-	X = 01-32	
Fault: No corresponding jump label present or backward jump	-	JC X E1/ \overline{JC} X E1		
Jump Label (LaBel) Passive jump destination for JC				294
Master Reset				300
Activate (trigger)	MR X T _L	-	X = 01-32	
Set all outputs and markers to zero state	-	MR X Q1/ \overline{MR} X Q1		
Data multiplexer (easy800 and MFD-CP10...)				303
Enable	MX X EN	-	X = 01-32	
Fault: Incorrect parameter setting, 0 > K > 7	-	MX X E1/ \overline{MX} X E1		
Numerical Converter				307
Enable	NC X EN	-	X = 01-32	
Operating Hours Counter				312
Enable	OT X EN	-	X = 01-04	
Reset	OT X RE			
Value overflow (carry)	-	OT X CY/ \overline{OT} X CY		
Set time reached		OT X Q1/ \overline{OT} X Q1		
Put value on NET (PUT)				315
Activate (trigger)	PT X T _L	-	X = 01-32	
Enable active	-	PT X Q1/ \overline{PT} X Q1		
Pulse Width Modulation				319
Enable	PW X EN	-	X = 01, 02	
Fault: Minimum on/off time exceeded	-	PW X E1/ \overline{PW} X E1		

4 Wiring with MFD

4.2 Circuit diagram elements

Contact	Coil (* = NET-ID 1-8)	Contact N/O - N/C (* = NET-ID 1-8)	Number	Page
Synchronize clock via NET (Set clock)				323
Trigger	SC X T _L	SC X T _L	X = 01	
Trigger acknowledgement	SC X Q1 SC̄ X Q1	SC X Q1/ \overline{SC} X Q1		
Shift Register				325
Enable	SR X EN	-	X = 01-32	
Shift Register	-	SR X Q1-8/ \overline{SR} X Q1-8		
Set Cycle Time				337
Enable	ST X EN	-	X = 01	
Timing Relay				340
Enable	T X EN	-	X = 01-32	
Timing relay reset	T X RE			
Timing relay Stop	T X ST			
Timing Relay-Switching contact	-	T X Q1/ \overline{T} X Q1		
Table Function				350
Enable	TB X EN	-	X = 01-32	
Table empty	-	TB X TE/ \overline{TB} X TE		
Table full		TB X TF/ \overline{TB} X TF		
Value Limit				355
Enable	VC X EN	-	X = 01-32	

A list with an overview of the function blocks and a brief description of function block coils and contacts is provided at → Section "11.4 List of function blocks" on page 458.

4.2.6 Markers and analog operands

The term "Marker" generally refers to the standard marker bit (M), also called auxiliary relay. MFD devices also process marker bytes (MB), marker words (MW) and marker double words (MD). Markers are used in the appropriate format for the intermediate storage of data. The marker bits (M) are used accordingly to store Boolean states 0 or 1.

You can use marker bits (M), marker bytes (MB), marker words (MW) and marker double words (MD) in the circuit diagram and function block diagram as well as in the visualization.

Table 23: Markers and analog operands

Markers and analog operand	MFD display	Number	Value range	Access type r = read w = write
Marker 32 bit	MD	01-96	32 Bit	r, w
Marker 16 bit	MW	01-96	16 bits	r, w
Marker 8 bit	MB	01-96	8 bit	r, w
Marker 1 bit	M	1-96	1-bit	r, w
Analog inputs of the MFD-R..., MFD-T... input/output module	IA X	X=01-04	10 Bit	r
Analog inputs of the MFD-TP.../-TAP... input/output module for temperature measuring	IA X alternatively via MD 01-96	X=01, 02	12bit	r
Analog output of the MFD-R.../MFD-T... input/output module	QA X	X=01	10 Bit	r, w
Analog output of the MFD-TAP... input/ output module for temperature measuring	QA X alternatively via MD 01-96	X=01	12 bits	r, w
Analog inputs, expansion unit with 2 analog inputs	MW X	X=93, 94	10 Bit	r
Analog inputs, expansion unit with 2 analog inputs	MW X	X=89...94	10 Bit	r
Analog output, expansion unit with 1 analog output	MW X	X=95	10 Bit	r, w
Analog output, expansion unit with 2 analog outputs	MW X	X=95, 96	10 Bit	r, w



Expansion units for analog value measuring can be used on easy800 devices from device version number 04 - like on all MFD devices. The analog inputs and outputs of the expansion units are read or written via permanently assigned marker words (see above table).

An MFD enables you to access specific operands of the remote station by means of a point-to-point serial connection called COM-LINK. These COM-LINK operands are identified by means of the preceding station number 1. The following table shows you the access to remote markers that can be set on the MFD via the System menu -> CONFIGURATOR -> COM... -> REMOTE MARKER. The table also shows you the access to remote analog values.

A detailed description of COM-LINK with a list of all available COM-LINK operands is provided in → Section "3.8 COM-LINK connection", on page 134.

4 Wiring with MFD

4.2 Circuit diagram elements

Table 24: Remote markers and remote analog operands

Markers and analog operand	MFD display	Number	Value range	Access type r = read w = write
Marker 32 bit	1MD	01...20	32 Bit	r, w
Marker 16 bit	1MW	01...40	16 bits	r, w
Marker 8 bit	1MB	01...80	8 bit	r, w
Marker 1 bit	1M	1...96	1-bit	r, w
Analog inputs basic device	1IA X	X=01...04	10 Bit	r
Analog output	1QA X	X=01	10 Bit	r

To use the markers MD, MW and MB as required for the binary operands (contacts), the following rules must be observed:

Table 25: Composition of the markers

Bit (M)	96-89	88-81	80-73	72-65	64-57	56-49	48-41	40-33	32-25	24-17	16-9	8-1
Byte (MB)	12	11	10	9	8	7	6	5	4	3	2	1
Word (MW)	6		5		4		3		2		1	
D-Word (MD)	3				2				1			
Byte (MB)	24	23	22	21	20	19	18	17	16	15	14	13
Word (MW)	12		11		10		9		8		7	
D-Word (MD)	6				5				4			
Byte (MB)	36	35	34	33	32	31	30	29	28	27	26	25
Word (MW)	18		17		16		15		14		13	
D-Word (MD)	9				8				7			
Byte (MB)	48	47	46	45	44	43	42	41	40	39	38	37
Word (MW)	24		23		22		21		20		19	
D-Word (MD)	12				11				10			
Byte (MB)	60	59	58	57	56	55	54	53	52	51	50	49
Word (MW)	30		29		28		27		26		25	
D-Word (MD)	15				14				13			
Byte (MB)	72	71	70	69	68	67	66	65	64	63	62	61
Word (MW)	36		35		34		33		32		31	
D-Word (MD)	18				17				16			
Byte (MB)	84	83	82	81	80	79	78	77	76	75	74	73
Word (MW)	42		41		40		39		38		37	
D-Word (MD)	21				20				19			
Byte (MB)	96	95	94	93	92	91	90	89	88	87	86	85
Word (MW)	48		47		46		45		44		43	
D-Word (MD)	24				23				22			

Marker range that can be declared as retentive

4 Wiring with MFD

4.2 Circuit diagram elements

Marker range that can not be declared as retentive 3)	Word (MW)	54	53	52	51	50	49
	D-Word (MD)	27		26		25	
	Word (MW)	60	59	58	57	56	55
	D-Word (MD)	30		29		28	
	Word (MW)	66	65	64	63	62	61
	D-Word (MD)	33		32		31	
	Word (MW)	72	71	70	69	68	67
	D-Word (MD)	36		35		34	
	Word (MW)	78	77	76	75	74	73
	D-Word (MD)	39		38		37	
	Word (MW)	84	83	82	81	80	79
	D-Word (MD)	42		41		40	
	Word (MW)	90 ¹⁾	89 ¹⁾	88	87	86	85
	D-Word (MD)	45		44		43	
	Word (MW)	96 ¹⁾	95 ²⁾	94 ²⁾	93 ²⁾	92 ¹⁾	91 ¹⁾
	D-Word (MD)	48		47		46	
	D-Word (MD)	51		50		49	
	D-Word (MD)	
	D-Word (MD)		96	
	<p>1) Marker word used as analog marker with appropriate parameter assignment of an EASY411-DC-ME analog expansion unit.</p> <p>2) Marker word used as analog marker with appropriate parameter assignment of an EASY406-DC-ME or EASY411-DC-ME analog expansion unit.</p> <p>3) Apart from the MFD-CP10..., on which the first 192 marker bytes can be declared as retentive.</p>						

The analog inputs and outputs (IA./QA.) of the MFD-Titan input/output module for temperature measuring can also be addressed via the marker double words MD1 - MD96. In this case you can scale the analog values and thus display them directly as temperature values (→ Chapter 3 "Commissioning", → Section "3.5.2.2 Menu SENSOR 1 or 2", page 110).

4 Wiring with MFD

4.2 Circuit diagram elements



Avoid any accidental double assignment of markers since it is possible to access physically identical memory ranges with different marker operands. Illustrates the marker allocation, → Table 25, page 154. For example, it is also possible to accidentally access the 96 marker bits via the first 12 marker bytes (MB), 6 marker words or 3 marker double words at the same time and therefore produce undefined states. With successive accesses within an MD, such as to MD1, MW2, MB4 or M32, the last write operation is retained. This also applies if you are writing marker ranges from a visualization screen.

Tip: By using marker bytes starting from MB13, marker words starting from MW07 and marker double words starting from MD04, double assignments with marker bits M01-M96 are prevented.

4.2.6.1 Retentive markers

You can declare a freely definable contiguous range between marker bytes as retentive, see → Table 25, page 154.

Device	Marker range that can be declared as retentive
MFD-CP8...	MB01 - MB96
MFD-CP10...	MB01 - MB192

The setting of retentive markers is explained in → Section "8.2.7 Storing data retentively (Retention menu item...)" on page 458.

4.2.6.2 Number formats

The MFD device processes calculations with a signed 31-bit value.

The value range is: -2147483648 to +2147483647

With a 31 bit value, the 32nd bit is the sign bit.

Bit 32 = status 0 -> positive number.

Example:

00000000000000000000010000010010_{bin} = 412_{hex} = 1042_{dec}

Bit 32 = status 1 -> negative number.

Example:

1111111111111111101110010101110_{bin} = FFFFDCAE_{hex} = -2147474606_{dec}

➔ The values of the data types marker byte (MB) and marker word (MW) are processed as unsigned. This must be remembered particularly if you wish to transfer the output of a standard function block which can take on negative values to the input of a function block and wish to buffer the value in the marker range.
If a used variable can take on negative values and you wish to store this in the marker range, you must assign a marker double word for it.

4.3 Circuit diagram display

You wire contacts and coils of relays in the MFD circuit diagram from left to right, from the contact to the coil. The circuit diagram is created on a hidden wiring grid containing contact fields, coil fields and rungs. It is then wired up with connections.

- Insert contacts in the four contact fields. The first contact field on the left is automatically connected to the voltage.
- In the coil field the relay coil to be controlled is entered with the coil identifier and coil function. The coil identifier consists of the coil name, coil number and, in the case of function blocks, with the function identifier. The coil function defines the method of operation of the coil.

Every line in the circuit diagram forms a circuit connection. With the MFD up to 256 rungs can be wired in a circuit diagram.

➔ There are 253 rungs available in the circuit diagram, for wiring contacts and coils. The device reserves 3 rungs per circuit diagram for internal management purposes.

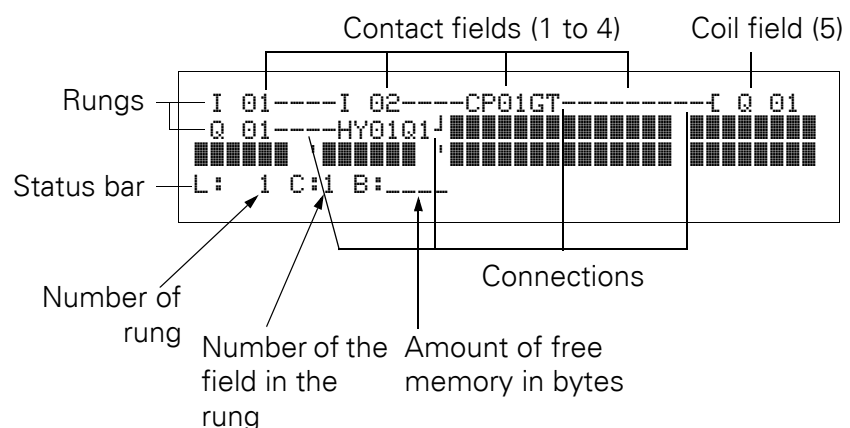

- Connections are used to produce the electrical contact between relay contacts and the coils. They can be created across several rungs. Each point of intersection is a connection.
- The number of free bytes is displayed so that you can recognize how much memory is available for the circuit diagram and function blocks.

4 Wiring with MFD

4.4 Program transfer from and to the memory card

4.3.0.1 MFD circuit diagram display

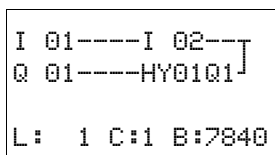

For greater legibility the circuit diagram of the MFD device shows two contacts or one contact plus coil in a row on each rung. A total of 16 characters per circuit connection and three circuit connections plus the status line can be displayed simultaneously.

The cursor buttons < > can be used to change the contact fields. The number of the circuit connection and the contact are displayed in the lower status line.



The circuit diagram display performs two functions:

- It is used to edit the circuit diagram in STOP mode.
- It is used in RUN mode to check the circuit diagram using the power flow display.

4.4 Program transfer from and to the memory card

Programs are transferred via the serial multi-function interface. There are two possibilities:

- From or to a MFD memory card, → Page 161.
- Via the programming cable from or to the COM serial PC interface and thus from or to the programming software easySoft-Pro, or in the Online Help.

How to remove the cover of the serial multi-function interface, connect a programming cable and fit a memory card is described in → Section "2.8 Connecting the serial multi-function interface" on page 88.

4.4.1 Information on the memory card

A program with all the necessary parameters can be loaded from the memory card into the MFD device or written from the device to the card.

- Each memory card can hold one MFD program.
- Information stored on the memory card is "non-volatile" and thus you can use the card to archive, transfer and copy your circuit diagram.

On the memory card you can save:

- The program,
- All the visualization data of the screens,
- All parameter settings of the circuit diagram,
 - P pushbuttons.
 - Input delay (debounce).
 - Password.
 - Retention on/off and area.
 - easyNet configuration.
 - Setting start in the Terminal mode.
 - COM-LINK settings.
 - Daylight Saving Time settings.

4.4.2 Transfer from/to a device without display or keypad

On devices without display and keypad you can transfer the program as follows:

- with easySoft-Pro from the PC.
- automatically from the fitted memory card every time the supply voltage is switched on (see also → Section "8.2.3.2 CARD MODE", page 453).

The MFD devices without a display are activated automatically when CARD MODE is active.



However, observe the restrictions for different device versions described in the following section!

4.4.3 Compatibility of program and MFD device

The easy800 and MFD device families allow programs from an older version to be read in newer device versions without any restrictions in function.

4.4.3.1 Compatibility

Definition

Downward compatibility is provided when a newer version of a software can open and process a program created with an older version.

Upward compatibility is provided when an older version of a software can open and process a program created with a newer software version.

Downward compatibility with MFD devices

A memory card with a program and a visualization application can always be read by an MFD device that has a newer operating system (with a higher version number) than the device from which the memory card was written. The program read back and/or the visualization application is executable.



The MFD-CP10... does not support easy800 programs.

4 Wiring with MFD

4.4 Program transfer from and to the memory card

Upward compatibility on MFD devices

If a program is written to the memory card by an MFD device with a newer operating system, this program can also be read and run by an MFD device with an older operating system. This requires that the program does not contain any functions that are not supported by the older operating system.

A visualization application is not transferred to an MFD device with an older operating system.

If the program contains functions that are not supported by the older operating system, the PROG INVALID! fault message appears with the CARD -> DEVICE transfer.

Table 26: Compatibility matrix for program exchange between devices

Write card from device ...→	MFD-CP8, V01	MFD-CP8, V05	MFD-CP8, V08	MFD-CP10, [OS-V1.00]
↓ Card read with device...				
MFD-CP8, V01	OK	–	–	–
MFD-CP8, V05	OK	OK	–	–
MFD-CP8, V08	OK	OK	OK	–
MFD-CP10, [OS-V1.00]	OK	OK	OK	OK

Program exchange between devices with memory card or easySoft-Pro

Programs can be loaded and run on devices with the same device version within the easy800 device family or devices with the same device version within the MFD-Titan device family, even if the target device does not have the necessary hardware requirements, see example.

Example: A program with NET operands (e.g. 3RN01) that was created for a network-enabled MFD-Titan is loaded on an MFD-Titan without an easyNet connection. On the MFD without the easyNet connection, all NET operands supply the value zero.

4.4.4 Loading and saving with a memory card

The loading of a program from the memory card and the saving on the card is carried out via the CARD menu. The following overview shows how you operate with and without password.

For easy800 and MFD-CP8 devices only use the EASY-M-256K card. With MFD-CP10... use the EASY-M-512K card for storing and reading a program. An MFD-CP10... can read the EASY-M-256K card in order to load an MFD-...-CP8 program.



The program is only transferred in STOP operating mode and when the supply voltage is switched on. If the supply voltage fails when the card is accessed, you must repeat the transfer as the data is possibly not fully transferred.

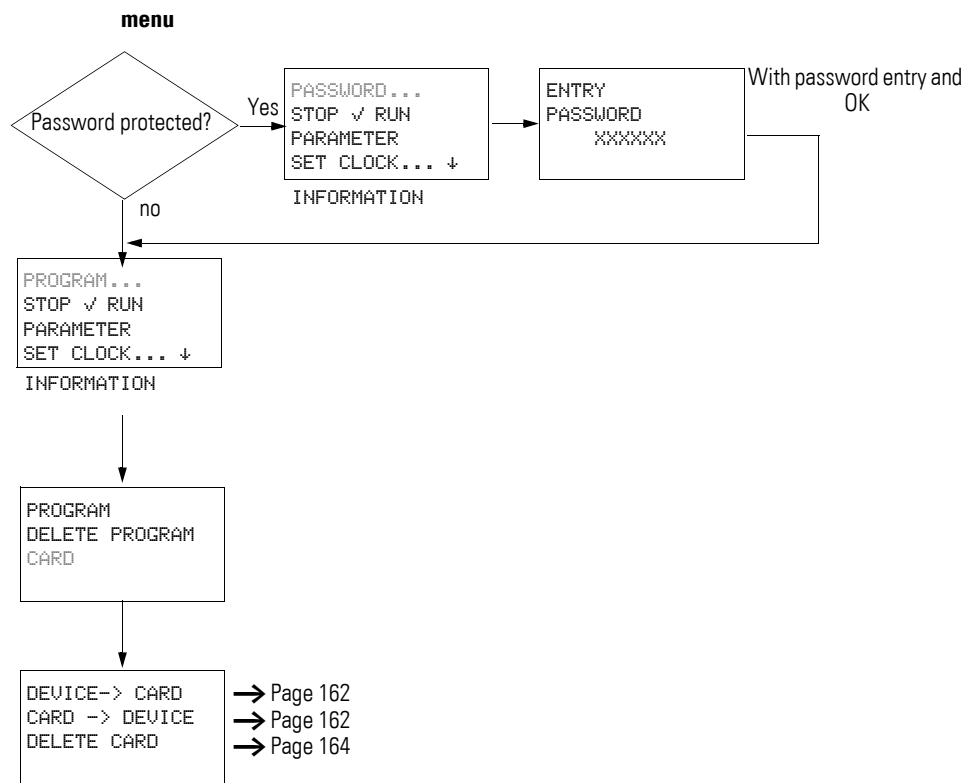

Figure 107: Choose CARD menu

When a memory card is fitted, and when the programs in the device and on the card are different, the MFD always loads the program from the card.

4 Wiring with MFD

4.4 Program transfer from and to the memory card

4.4.4.1 Saving a program on the memory card (DEVICE -> CARD)



In devices without a display and keypad, transferring a program to the memory card is not possible.

Basic requirements:

- The device in the STOP.
- A memory card must be fitted in the device.
- You are in the CARD menu and password protection is removed, → Figure 107, page 161.
- ▶ Select DEVICE->CARD.
- ▶ Confirm the confirmation request with OK or abort the save operation with ESC.

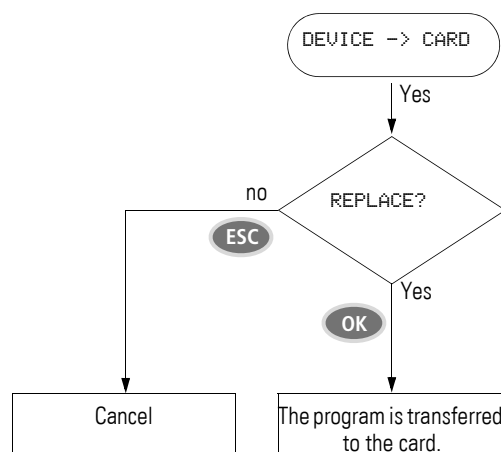

Figure 108: Save program on card

4.4.4.2 Loading the program from the card (CARD -> DEVICE)

If a program on the memory card is invalid, a program in the MFD device is retained.

Basic requirements:

- The device in the STOP.
- A memory card with a valid program or a circuit diagram must be fitted in the device.
- You are in the CARD menu and password protection is removed, → Figure 107, page 161.



All passwords that are present when saving to the card are also reactivated after the card is loaded.

- ▶ Select DEVICE->CARD.
- ▶ Confirm the confirmation request with OK or abort the load operation with ESC.



An MFD-CP8... can load a program from the EASY-M-256K card.
An MFD-CP10... can load a program from the EASY-M-256K and EASY-M-512K cards.

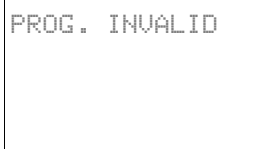

If there are transmission problems, MFD will display the INVALID PROG message.

Possible causes:

- The memory card is empty.
- A checksum error was detected when comparing the stored checksum and the checksum calculated for the transfer.
- The circuit diagram on the card uses a function block that the MFD device does not recognize, for example the PO, Pulse Output function block.

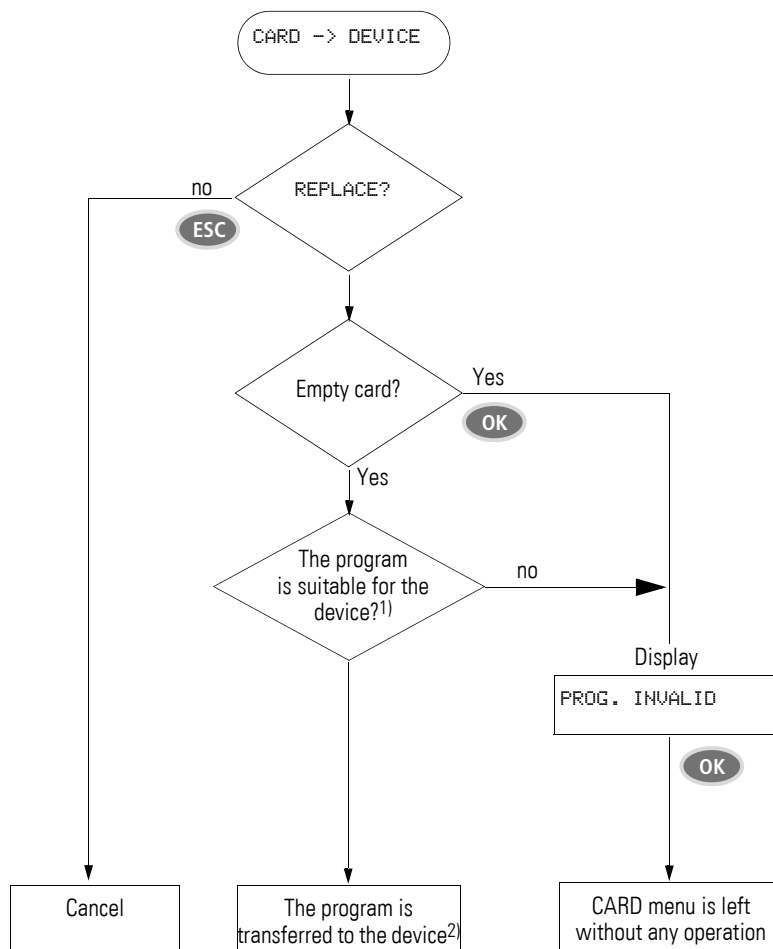

Figure 109: Loading a program from the card

- 1) The storing device saves its type and version on the card. A program to be loaded from the card must be suitable for the destination device otherwise this will refuse the transfer.
- 2) If there is a transfer problem or a check sum error, the MFD device will output the message PROG INVALID.

4 Wiring with MFD

4.5 Deleting a program on the card

4.5 Deleting a program on the card

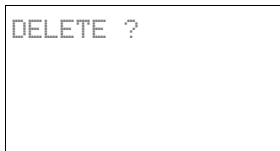

Requirement: You must be in the CARD menu.

- ▶ Select the DELETE CARD menu.
- ▶ Confirm the safety prompt DELETE ? with OK if you wish to delete the card content.

Press ESC to cancel.

- ▶ After transferring or deleting a program, remove the memory card and close the cover.

4.6 Loading and saving with easySoft-Pro

easySoft-Pro is a PC program with which you can do the following to an MFD program and a visualization application:

- create it.
- test it in a simulation tool.
- document and manage it.
- write or read it to or from a connected and functional MFD device.
- test it in RUN mode (Online) in the actual wiring.



Only use the programming cable provided in the original accessories for transferring data between the PC and the MFD device (→ Section "2.8.1 Connection to a PC" on page 89).

CAUTION

When connecting the programming cable, the easySoft-Pro programming software must be offline. On no account should the programming cable be replugged from one MFD device to another when a connection has been established (online status).



A MFD device cannot exchange data with the PC if it has been switched to the circuit diagram display.

Further information with detailed operator manual on the easySoft-Pro programming software is provided in the online help.

- ▶ Launch easySoft-Pro and then open the Help system by clicking ? or by pressing function key F1

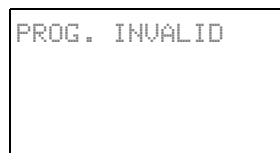

If there is a transfer error, the MFD device shows the PROG. INVALID message.

- ▶ Check whether you are using functions that the MFD device does not recognize.



If the operating voltage fails during communication with the PC, repeat the last transfer step. Not all data may have been transferred between the PC and MFD device.

- ▶ Cover the interface after you have removed the cable after a transfer.

4.7 Working with contacts and relays

Switches, pushbuttons and relays from a conventional hardwired circuit diagram are wired in the MFD circuit diagram via input contacts and relay coils.

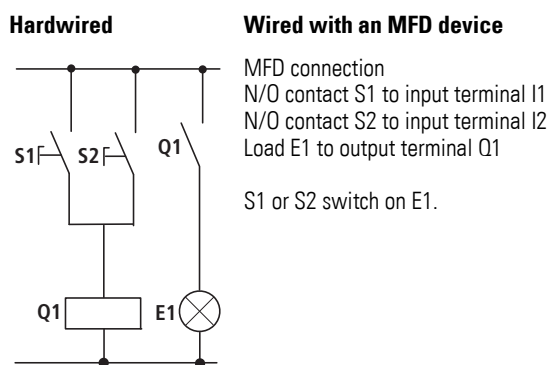

MFD circuit diagram:

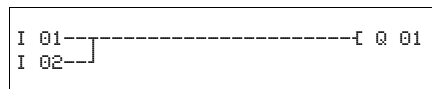

Figure 110: Circuit diagram with inputs I 01, I 02 and output Q 01

First specify which input and output terminals you wish to use in your circuit.

The signal states on the input terminals are detected in the circuit diagram with the input contacts I, R or RN. The outputs are switched in the circuit diagram with the output relays Q, S or SN.

The jump destination has a special position for the input contacts and the jump location for the output relays. These are used for structuring a circuit diagram (→ Section "4.7.11 Jumps", page 177).

4 Wiring with MFD

4.7 Working with contacts and relays

4.7.1 Entering and changing contacts and coils

The following describes how you wire the different contacts and coils of different relay types or function blocks (inputs) in the circuit diagram.

4.7.1.1 Contacts

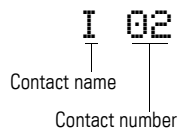

You choose an input contact in the MFD device by means of the contact name and the contact number.

Example: Input contact basic device

or

Example: Input contact via NET (here from NET station 3)

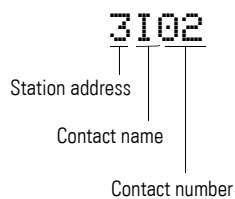

The contact of a function block consists of the abbreviated function block name, the number and the contact function.

Example: Contact of "comparator" function block

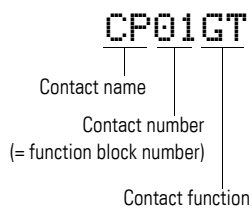

How a safety or standard function block is added to the circuit diagram and parameterized is described in → Section "4.9 Working with function blocks" on page 188.

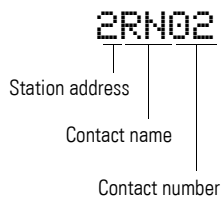

If the contact of an Net station is used in the circuit diagram, the NET ID (address) of the station is placed in front of the contact name, → section "4.7.12.1 Setting the NET ID of a NET operand", page 179.

Example: Contact of a NET station

4.7.1.2 Coils

With a relay coil or a function block, you choose the coil function, coil name, coil number as well as the function block coil. With coils of an easyNet station, choose the address (NET ID) in front of the coil name.

➔ The coil number in the figures on the left must be the same as the function block number!

S Q 04
 Coil Function Coil name Coil number

Example: Relay coil "Output Q"

⌈ T 04EN
 Coil Function Coil name Coil number Function block coil
 (= function block name)

Example: Relay coil for timing relay function block with control coil

S2SN04
 Coil Function Station address Coil name Coil number

Example: Relay coil of a NET station

➔ A complete list of all contacts and coils, ➔ section "11.4 List of function blocks", page 516.

I 01 Values for contacts and coil fields are changed in Entry mode. The value to be changed flashes.

➔ The MFD device proposes contact I 01 or the coil ⌈ Q 01 for entry in an empty field.

- ▶ Use < > ^v to move the cursor to a contact or coil field.
- ▶ Press OK to switch to Entry mode.
- ▶ Use < > to select the position you wish to change and press OK to move to the next position (a selected position is shown in light grey in the following figure).
- ▶ Use ^v to modify the value of the position.

4 Wiring with MFD

4.7 Working with contacts and relays

The MFD device closes entry mode as soon as you leave a contact or coil field with < > or OK.

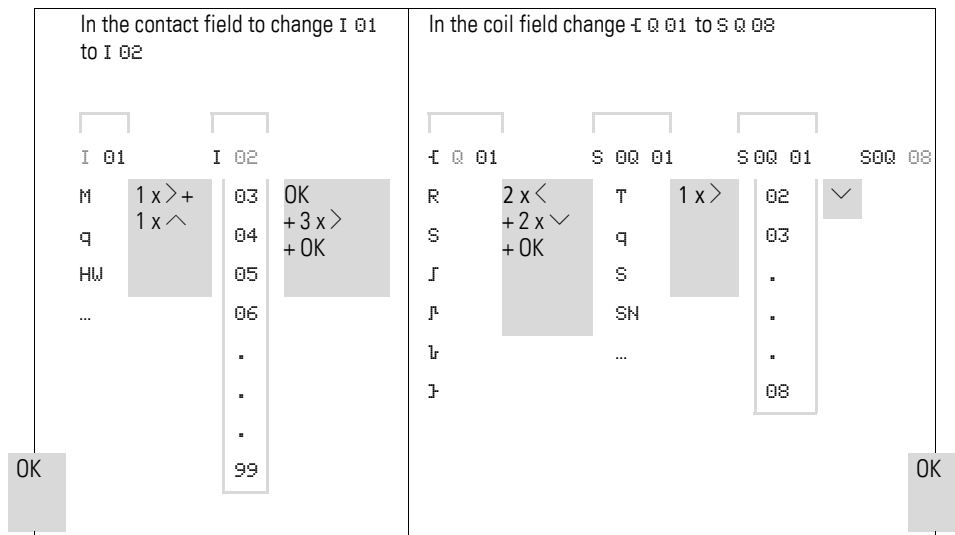

4.7.1.3 Deleting contacts and coils

- ▶ Use < > ^ ^ to move the cursor to a contact or coil field.
- ▶ Press DEL.

The contact or the coil will be deleted, together with any connections.

4.7.1.4 Changing N/O contacts to N/C contacts

You can define each contact in the circuit diagram as a N/O or N/C.

- ▶ Switch to Entry mode and move the cursor over the contact name.
- ▶ Press ALT. The N/O contact will change to a N/C contact.
- ▶ Press OK twice to confirm the change.

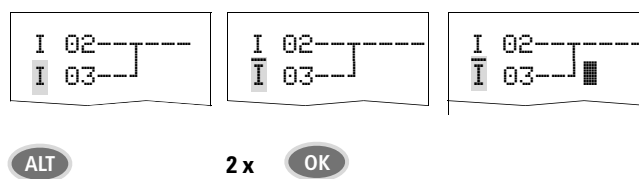

Figure 111: Change contact I 03 from N/O to N/C

4.7.2 Creating or changing connections

Contacts and relay coils are connected with the wiring arrow in Connect mode. The MFD device displays the cursor in this mode as a wiring arrow.

- ▶ Use < > ^ v to move the cursor to the contact or coil field from which you wish to create a connection.



Do not position the cursor on the first contact field. Here the ALT button has a different function (add rung).

- ▶ Press ALT to switch to Connect mode.
- ▶ Use < > to move the arrow between the contact and coil fields and use ^ v to move between the rungs.
- ▶ Press ALT to leave Connect mode.

The MFD device closes the mode automatically as soon as you have moved the arrow to an occupied contact or coil field.



In a rung, the MFD device connects contacts and the connection to the relay coil automatically if no empty fields are between them.

Never wire backwards, → Section "9.1.3.2 Example: Do not wire backwards", page 469.

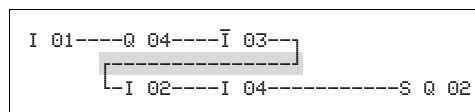

Figure 112: Circuit diagram with five contacts, invalid

With more than four contacts in series, use one of the 96 M markers.

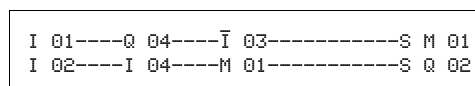

Figure 113: Circuit diagram with M marker relay

4.7.2.1 Deleting Connections

- ▶ Move the cursor onto the contact field or coil field to the right of the connection that you want to delete. Press ALT to switch to Connect mode.
- ▶ Press DEL.

The MFD device deletes a connection branch. Closed adjacent connections will be retained.

- ▶ Close the delete operation with ALT or by moving the cursor to a contact or coil field.

4 Wiring with MFD

4.7 Working with contacts and relays

4.7.3 Adding or deleting rungs

The circuit diagram display shows three of the 256 rungs at the same time. Rungs outside of the display, including empty rungs, are scrolled by MFD automatically in the circuit diagram display if you move the cursor beyond the top or bottom of the display.

A new rung is added below the last connection or inserted above the cursor position:

- ▶ Position the cursor on the first contact field of a rung.
- ▶ Press ALT.

The existing rung with all its additional connections is "shifted" downwards. The cursor is then positioned directly in the new rung.

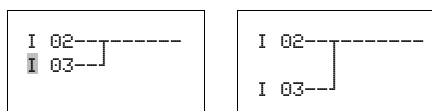
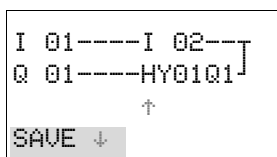

Figure 114: Inserting a new rung

4.7.4 Saving circuit diagrams

- ▶ Press ESC to save a circuit diagram.



The menu on the left appears in the status line.

- ▶ Pressing OK will save the entire program, circuit diagram and function blocks.

After saving, you will be returned to the previous menu from which you have opened the circuit diagram.

4.7.5 Aborting circuit diagram entry

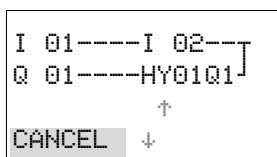

- ▶ Press ESC to leave the circuit diagram entry without saving.
- ▶ Use the cursor buttons ^v to select the CANCEL menu.
- ▶ Press OK.

The circuit diagram is closed without saving.

4.7.6 Searching for contacts and coils

```

I 01----I 02--J
Q 01----HY01Q1J
SEARCH  ↑
          ↓

```

Boolean operands or function blocks that are wired as contacts or coils can be found in the following way:

- ▶ Press ESC. Use the cursor buttons ^v to enter the SEARCH menu.
- ▶ Press OK.

```

I 01----I 02--J
Q 01----HY01Q1J
SEARCH I 01

```

- ▶ Use the cursor buttons v and <> to select a contact or coil as well as the required number.

For a function block you select the function block name and the number.

- ▶ Confirm the search with the OK pushbutton.

```

I 01----I 02--J
Q 01----HY01Q1J
L: 1 C:1 B:7140

```

The search starts from where the search was called and is continued to the end of the circuit diagram. If the required contact or the coil are not found, the search starts at the beginning of the circuit diagram. If the search is successful, you are taken automatically to the required contact or coil field in the circuit diagram.

4.7.7 Got to a rung

The GO TO function can be used to go to a different rung.

- ▶ Press ESC and use cursor buttons ^v to select the GO TO menu.
- ▶ Press OK.
- ▶ Select the required rung (L?) with the Iú cursor buttons.

```

I 01----I 02--J
Q 01----HY01Q1J
L: 1 C:1 B:7140

```

Always the first contact of the rung is displayed.

- ▶ Press OK.

```

I 01----I 02--J
Q 01----HY01Q1J
L: 1 C:1 B:7140

```

The cursor stops at the first contact L 1 of the required rung.



You can use the "GO TO" function to jump to any rung, up to the last wired rung.

4.7.8 Delete Rung

The MFD device only removes empty rungs (without contacts or coils).

- ▶ Delete all contacts and coils from the rung.
- ▶ Position the cursor on the first contact field of the empty rung.
- ▶ Press DEL.

The subsequent rung(s) will be "pulled up" and any existing links between rungs will be retained.

4 Wiring with MFD

4.7 Working with contacts and relays

4.7.9 Switching with the Cursor Buttons

An MFD-CP8... enables you to use the four cursor buttons as hard-wired inputs in the circuit diagram if these are assigned P button functions in the button editor → section "6.6.12 P button function", page 427.

The other operator buttons on the MFD-CP10... can be used as additional inputs.

The cursor buttons are wired in the circuit diagram as contacts P 01 to P 04.

Requirement for switching with the cursor buttons: The P buttons must be activated in the System menu → section "1.6.10 System menu", page 34.

The P buttons can also be used for testing circuits or manual mode. These button functions are also useful for servicing and commissioning purposes.

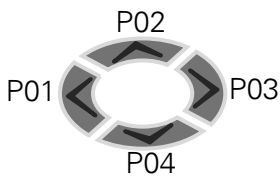

Example 1

This standard circuit diagram example enables a lamp at output Q1 to either be switched on or off via the inputs I1 and I2 or via the cursor buttons ^ and v.

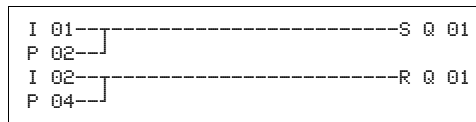

Figure 115: Switch Q1 via I1, I2, ^, or v

Example 2

This circuit diagram example causes output Q1 to be actuated by input I1. I5 switches to cursor operation and disconnects the rung I 01 via M 01.

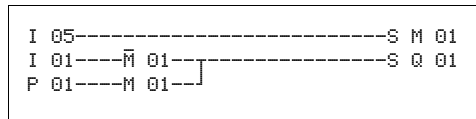

Figure 116: I5 switches to cursor buttons.



The MFD device only evaluates P button entries if the status display is shown.

The Status menu display shows whether the P buttons are used in the circuit diagram.

Display in Status display:

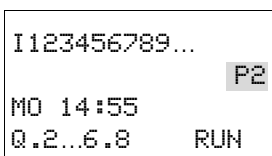

- P: Button function wired and active,
- P2: Pushbutton function wired, active and P2 pushbutton ^ executed,
- P-: Button function wired, not active,
- Empty field: P pushbuttons not used.

4.7.9.1 Checking the circuit diagram

The MFD device features an integrated power flow display with which you can follow the switching states of contacts, relay and function block coils during operation.

- ▶ Create the small parallel circuit below and save it.

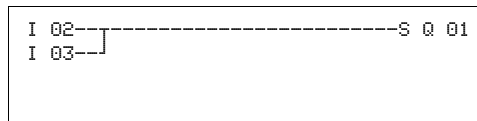

Figure 117: Parallel connection

- ▶ Switch the MFD to RUN via the main menu.
- ▶ Return to the circuit diagram display.

You are now unable to edit the circuit diagram.



If you change to the circuit diagram display but cannot change a circuit diagram, first check whether the MFD device is in STOP mode.

The circuit diagram display performs two functions depending on the mode:

- STOP: Create the circuit diagram.
 - RUN: Power flow display.
- ▶ Switch on I3.

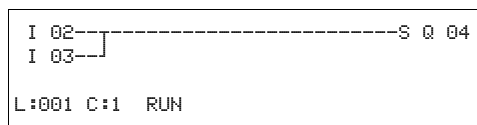

Figure 118: Power flow display

In the power flow display, energized connections are thicker than non-energized connections.

You can follow energized connections across all rungs by scrolling the display up and down.

The power flow display indicates at the bottom right the controller is in RUN mode. (→ section " Power flow display with Zoom function ", page 105).



The power flow display does not show signal changes in the millisecond range due to the inherent technical delay of LCD displays.

4 Wiring with MFD

4.7 Working with contacts and relays

4.7.10 Coil Functions

You can set the coil function to determine the switching behavior of relay coils. The following coil functions are available for all coils:

Table 27: Coil Function

MFD display	Coil Function	Example	→ Page
⌈	Contactor Function	⌈0011, ⌈0012, ⌈0014, ⌈01, ⌈1017, ..	174
⌋	Impulse Relay Function	⌋003, ⌋004, ⌋008, ⌋07, ⌋01, ..	175
S	Set	S008, SM02, SD03, SS04 ..	175
R	Reset	R004, RM05, RD07, RS03 ..	175
⌋̄	Contactor function with negated result	⌋̄004, ⌋̄06 ..	176
⌈̄	Cycle pulse on rising edge	⌈̄01 ..	176
⌋̄	Cycle pulse on falling edge	⌋̄42 ..	176



The function block coil functions that can be used are described with the function blocks.



With non-retentive coil functions such as ⌈ (contactor), ⌋̄ (negated contactor), ⌈̄, ⌋̄ (rising and falling edge evaluation): Each coil must only be used once. The last coil in the circuit diagram determines the state of the relay. Exception: When working with jumps, the same coil can be used twice. Retentive coil functions such as S, R, ⌋ can be used several times.

4.7.10.1 Coil with contactor function ⌈

The output signal follows the input signal directly, the relay operates as a contactor.

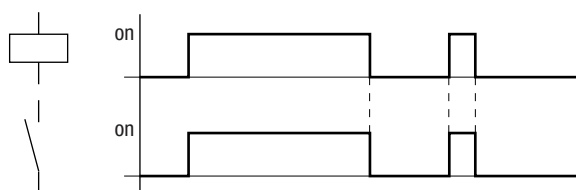

Figure 119: Contactor function signal diagram

4.7.10.2 Impulse relay J

The relay coil switches whenever the input signal changes from 0 to 1. The relay behaves like a bistable flip-flop.

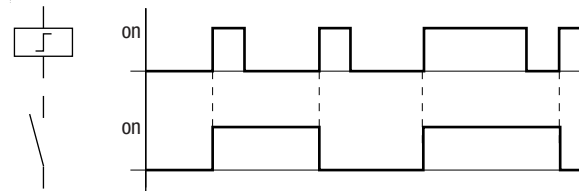

Figure 120: Impulse relay signal diagram

A coil is automatically switched off in the event of a power failure and in STOP mode. Exception: Retentive coils retain signal 1 (→ Section "8.2.7 Storing data retentively (Retention menu item...)", page 458).

4.7.10.3 "Set" S and "Reset" R coil function

The Set S and Reset R coil functions are normally used in pairs.

The relay picks up when the coil is set (A) and remains in this state until it is reset (B) by the coil function.

The supply voltage is switched off (C), the coil is not retentive.

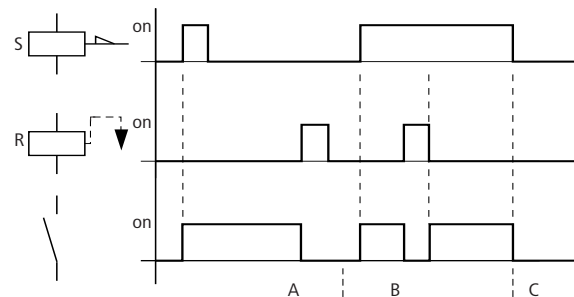

Figure 121: Set and Reset signal diagram

If both coils are actuated simultaneously, the coil with the higher rung number has priority, in this case the reset coil, as shown in the signal diagram at (B).

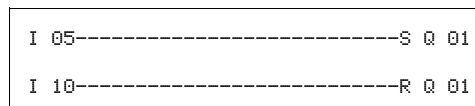

Figure 122: Simultaneous triggering of Q 01

The above example shows the Reset coil with priority when the Set and Reset coil are triggered at the same time.

4 Wiring with MFD

4.7 Working with contacts and relays

4.7.10.4 Coil negation (inverse contactor function) $\bar{1}$

The output signal follows the inverted input signal, the relay works like a contactor with negated contacts. If the coil is set to 1, the coil will switch its make contacts to 0.

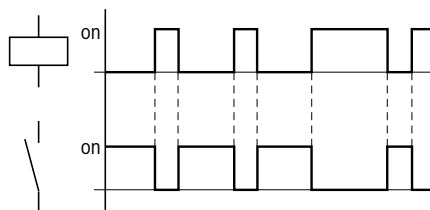

Figure 123: Inverse contactor function signal diagram

4.7.10.5 Rising edge evaluation (cycle pulse) $\bar{1}$

This function is used if the coil is only meant to switch on a rising edge. When the coil status changes from 0 to 1, the coil switches its make contacts to 1 for one cycle.

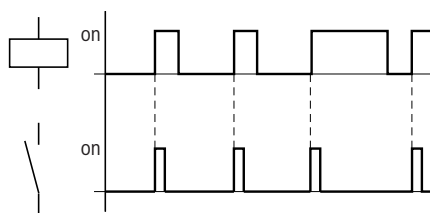

Figure 124: Signal diagram of cycle pulse with rising edge

4.7.10.6 Falling edge evaluation (cycle pulse) $\bar{1}$

This function is used if the coil is only meant to switch on a falling edge. When the coil status drops out from 1 to 0, the coil switches its make contacts to 1 for one cycle.

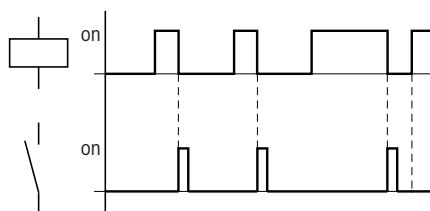

Figure 125: Signal diagram of cycle pulse with negative edge



A set coil is automatically switched off in the event of a power failure and in STOP mode. Exception: Retentive coils retain signal 1 (→ Section "8.2.7 Storing data retentively (Retention menu item...)", page 458).

4.7.11 Jumps

Jumps ... can be used for structuring a circuit diagram.

They replace the function of a selector switch. Jumps can be used, for example, to implement the selection of manual/automatic mode or various machine programs.

Jumps ... consist of a jump location and a jump destination (label) and are only used in the circuit diagram.

Details on the use of jumps in the function block diagram are provided → Section "5.18 LB, jump label" in on page 294 and → Section "5.17 JC, conditional jump" in on page 291.

The MFD device allows the use of up to 32 jumps.

4.7.11.1 Circuit diagram symbols for jumps

Contact	
N/O contact ¹⁾	:
Numbers	01 up to 32
Coils	⌈
Numbers	01 up to 32
Coil Function	⌈, ⌋, ⌊, ⌋, ⌋

1) Can only be used as first contact on the left

4.7.11.2 Function of jumps

If the jump coil is triggered, the rungs after the jump coil are no longer processed. The states of the coils before the jump will be retained, unless they are overwritten in rungs that were not missed by the jump. Jumps are always made forwards, i.e. the jump ends on the first contact with the same number as that of the coil.

- Coil = jump on 1 state
- Contact only at the first leftmost contact = Jump label

The jump contact location is always 1.



Backward jumps cannot be executed due to the way in which MFD works. If the jump label does not come after the jump coil, the jump will be made to the end of the circuit diagram. The last rung is also skipped.

Multiple usage of the same jump coil and the same contact is possible as long as this is done in pairs, this means:

- Coil ⌈:1/jumped area/contact :1,
 - Coil ⌈:1/jumped area/contact :1,
- etc.

4 Wiring with MFD

4.7 Working with contacts and relays

CAUTION

If rungs are skipped, the states of the coils are retained.
The time of started timing relays continues to run.

4.7.11.3 Power flow display of skipped area

Jumped sections are indicated by the coils in the power flow display.
All coils after the jump coil are shown with the symbol of the jump coil.

4.7.11.4 Example for jumps

A selector switch is used to select two different sequences.

- Sequence 1: Switch on motor 1 immediately.
- Sequence 2: Activate barrier 2, wait time, then switch on motor 1.

Contacts and relays used:

- I1 sequence 1
- I2 sequence 2
- I3 guard 2 moved out
- I12 motor protective circuit breaker switched on
- Q1 motor 1
- Q2 guard 2
- T 01 wait time 30.00 s, on-delayed
- D 01 Text "Motor protective circuit breaker tripped"

Circuit diagram:

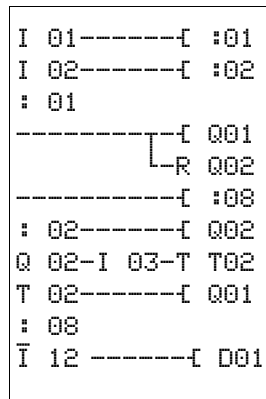

Power flow display: I 01 selected:

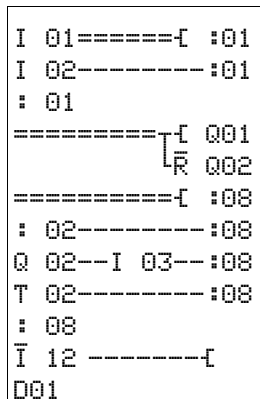

Range from jump label 1 processed.

Jump to label 8.
Range to jump label 8 skipped.

Jump label 8, circuit diagram processed from this point on.

4.7.12 Wiring NET operands in the circuit diagram

The NET operands that can be used depend on the operation of the devices on the NET and the following types of application:

Operating devices on the NET	Usable NET operands of data type...	
	Bit	32 Bit (DWord)
REMOTE IO mode; only NET station 1 processes a circuit diagram.	nI.., nR.., nQ.., nS...	–
All NET stations each process a circuit diagram.	nI.., nR.., nQ.., nS.., nRN.., nSN...	nPT.. and nGT...
Mixed operation of NET stations with and without a circuit diagram.	nI.., nR.., nQ.., nS.., nRN.., nSN...	nPT.. and nGT...

4.7.12.1 Setting the NET ID of a NET operand

Requirement: You must have selected an I.., R.., Q.., R.., RN.. S.. or SN.. operand in the circuit diagram and Entry mode must have been selected.

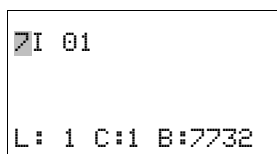
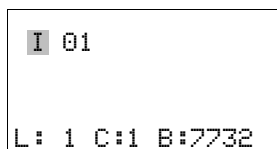

This mode is displayed by a flashing operand.

- ▶ Use the cursor button < to move the cursor to the position to the left of the operand. A flashing zero appears as the initial value.

Enter the cursor buttons ^ or v to define the required NET ID; in this case NET ID 7.

Confirm the entry with the OK button.

The local I.., R.., Q.. or S.. operand has been changed to a NET operand nI.., nR.., nQ.. and nS...

Table 28: Location and addressing of the operands via easyNet

Station	Basic device via NET		Local expansion via NET		Bit data via NET		Word data via NET	
	Input nI	Output nQ	Input nR	Output nS	Input nRN	Output nSN	Receive	Send
1	2 I 1...2 I 16	2 Q 1...2 Q 8	2 R 1...2 R 16	2 S 1...2 S 8	2 RN 1...2 RN 32	2 SN 1...2 SN 32	GT 1	PT 1

	8 I 1...8 I 16	8 Q 1...8 Q 8	8 R 1...8 R 16	8 S 1...8 S 8	8 RN 1...8 RN 32	8 SN 1...8 SN 32
2	1 I 1...1 I 16	1 Q 1...1 Q 8	1 R 1...1 R 16	1 S 1...1 S 8	1 RN 1...1 RN 32	1 SN 1...1 SN 32	GT 1	PT 1

	3 I 1...3 I 16	3 Q 1...3 Q 8	3 R 1...3 R 16	3 S 1...3 S 8	3 RN 1...3 RN 32	3 SN 1...3 SN 32
3	1 I 1...1 I 16	1 Q 1...1 Q 8	1 R 1...1 R 16	1 S 1...1 S 8	1 RN 1...1 RN 32	1 SN 1...1 SN 32	GT 1	PT 1

	2 I 1...2 I 16	2 Q 1...2 Q 8	2 R 1...2 R 16	2 S 1...2 S 8	2 RN 1...2 RN 32	2 SN 1...2 SN 32
3	4 I 1...4 I 16	4 Q 1...4 Q 8	4 R 1...4 R 16	4 S 1...4 S 8	4 RN 1...4 RN 32	4 SN 1...4 SN 32

	8 I 1...8 I 16	8 Q 1...8 Q 8	8 R 1...8 R 16	8 S 1...8 S 8	8 RN 1...8 RN 32	8 SN 1...8 SN 32

4 Wiring with MFD

4.7 Working with contacts and relays

Station	Basic device via NET		Local expansion via NET		Bit data via NET		Word data via NET	
	Input nI	Output nQ	Input nR	Output nS	Input nRN	Output nSN	Receive	Send
4	1 I 1...1 I 16	1 Q 1...1 Q 8	1 R 1...1 R 16	1 S 1...1 S 8	1 RN 1...1 RN 32	1 SN 1...1 SN 32	GT 1	PT 1
	2 I 1...2 I 16	2 Q 1...2 Q 8	2 R 1...2 R 16	2 S 1...2 S 8	2 RN 1...2 RN 32	2 SN 1...2 SN 32
	3 I 1...3 I 16	3 Q 1...3 Q 8	3 R 1...3 R 16	3 S 1...3 S 8	3 RN 1...3 RN 32	3 SN 1...3 SN 32		
	5 I 1...5 I 16	5 Q 1...5 Q 8	5 R 1...5 R 16	5 S 1...5 S 8	5 RN 1...5 RN 32	5 SN 1...5 SN 32		
	8 I 1...8 I 16	8 Q 1...8 Q 8	8 R 1...8 R 16	8 S 1...8 S 8	8 RN 1...8 RN 32	8 SN 1...8 SN 32		
5	1 I 1...1 I 16	1 Q 1... Q 8	1 R 1...1 R 16	1 S 1...1 S 8	1 RN 1...1 RN 32	1 SN 1...1 SN 32	GT 1	PT 1
	4 I 1...4 I 16	4 Q 1...4 Q 8	4 R 1...4 R 16	4 S 1...4 S 8	4 RN 1...4 RN 32	4 SN 1...4 SN 32
	6 I 1...6 I 16	6 Q 1...6 Q 8	6 R 1...6 R 16	6 S 1...6 S 8	6 RN 1...6 RN 32	6 SN 1...6 SN 32		
	7 I 1...7 I 16	7 Q 1...7 Q 8	7 R 1...7 R 16	7 S 1...7 S 8	7 RN 1...7 RN 32	7 SN 1...7 SN 32		
	8 I 1...8 I 16	8 Q 1...8 Q 8	8 R 1...8 R 16	8 S 1...8 S 8	8 RN 1...8 RN 32	8 SN 1...8 SN 32		
6	1 I 1...1 I 16	1 Q 1...1 Q 8	1 R 1...1 R 16	1 S 1...1 S 8	1 RN 1...1 RN 32	1 SN 1...1 SN 32	GT 1	PT 1
	5 I 1...5 I 16	5 Q 1...5 Q 8	5 R 1...5 R 16	5 S 1...5 S 8	5 RN 1...5 RN 32	5 SN 1...5 SN 32
	7 I 1...7 I 16	7 Q 1...7 Q 8	7 R 1...7 R 16	7 S 1...7 S 8	7 RN 1...7 RN 32	7 SN 1...7 SN 32		
	8 I 1...8 I 16	8 Q 1...8 Q 8	8 R 1...8 R 16	8 S 1...8 S 8	8 RN 1...8 RN 32	8 SN 1...8 SN 32		
7	1 I 1...1 I 16	1 Q 1...1 Q 8	1 R 1...1 R 16	1 S 1...1 S 8	1 RN 1...1 RN 32	1 SN 1...1 SN 32	GT 1	PT 1
	6 I 1...6 I 16	6 Q 1...6 Q 8	6 R 1...6 R 16	6 S 1...6 S 8	6 RN 1...6 RN 32	6 SN 1...6 SN 32
	8 I 1...8 I 16	8 Q 1...8 Q 8	8 R 1...8 R 16	8 S 1...8 S 8	8 RN 1...8 RN 32	8 SN 1...8 SN 32		
8	1 I 1...1 I 16	1 Q 1...1 Q 8	1 R 1...1 R 16	1 S 1...1 S 8	1 RN 1...1 RN 32	1 SN 1...1 SN 32	GT 1	PT 1
	8 I 1...8 I 16	8 Q 1...8 Q 8	8 R 1...8 R 16	8 S 1...8 S 8	7 RN 1...7 RN 32	7 SN 1...7 SN 32

4.7.13 Read and write of NET operands

The NET operands nI.., nR.., nQ.. and nS.. can be read and/or written.

4.7.13.1 Reading of nI.., nR.., nQ.. and nS..

n = NET ID of the station with NET operands that are read or written. Each NET station with a standard circuit diagram can read the signal states at the input and output terminals of each other NET station via these operands wired as contacts. This is possible regardless of whether a circuit diagram is being processed or not on the NET station to be read. Use these nI.., nR.., nQ.. and nS.. NET operands to read the signal states of NET stations (NET-ID 2 - 8).

4.7.13.2 Reading inputs/outputs of an easySafety device via the NET

Inputs/outputs IS../QS of an easySafety device can be read in the circuit diagram of an MFD device via the NET operands nI.. and nQ..

Refer to the operator manual for the easySafety ES4P.... control relay for information how to complete the assignment.

4.7.13.3 Writing of nQ.. and nS..

Only NET station 1 has write access via the nQ.. and nS.. operands. It writes via coils nQ.. and nS.. to the output terminals of another NET station which is running in REMOTE IO mode without a circuit diagram.

Example 1:

NET station 1 is required to read data from input I1 of NET station 2 and write data to output Q1 of NET station 2. NET station 2 does not have a circuit diagram.

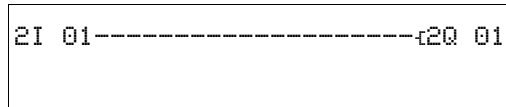

Figure 126: Circuit diagram in NET station 1

4.7.14 NET operands nRN.. (input) and nSN.. (output)

To use these NET operands, the sending and receiving station must each have a circuit diagram.

The NET stations for bit exchange must always use the RN and SN in pairs (→ Figure 127, page 182 and 128).

4.7.14.1 Writing via SN

The NET operand SN (Send NET) is used for sending bit data from one NET station to another. To do this you select the SN operand in a coil field.

4.7.14.2 Reading using RN

The RN (Receive NET) NET operand is used to receive the bit data that another NET station has sent. To do this you select the RN operand in a contact field.

4.7.14.3 SN-RN combination

As the RN and SN must always be used in pairs, the following rule applies:

- on the sending station and receiving station use the same operand number for each SN/RN pair to be formed.
- in the circuit diagram of the sending station you set for the SN operand (coil) the station number (NET ID) of the receiving station.
- in the circuit diagram of the receiving station you set for the RN operand (contact) the station number (NET ID) of the sending station.

4 Wiring with MFD

4.7 Working with contacts and relays

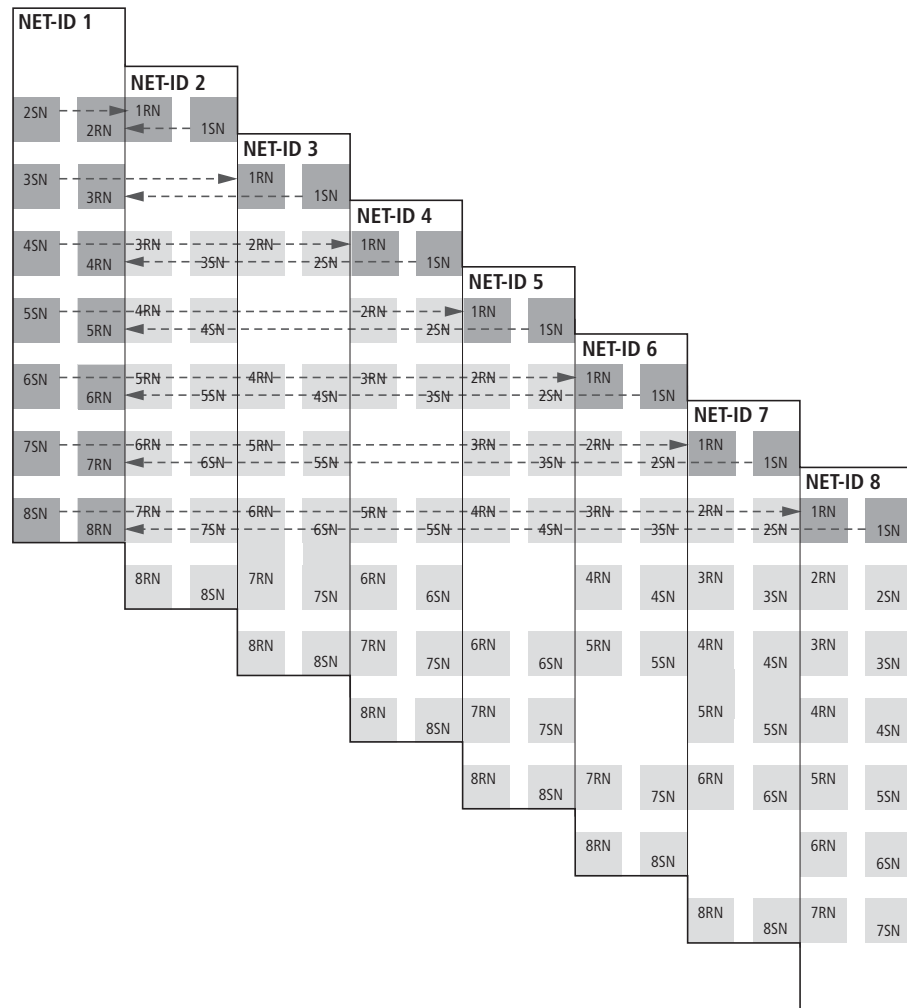

Figure 127: SN-RN combinations of NET station 1

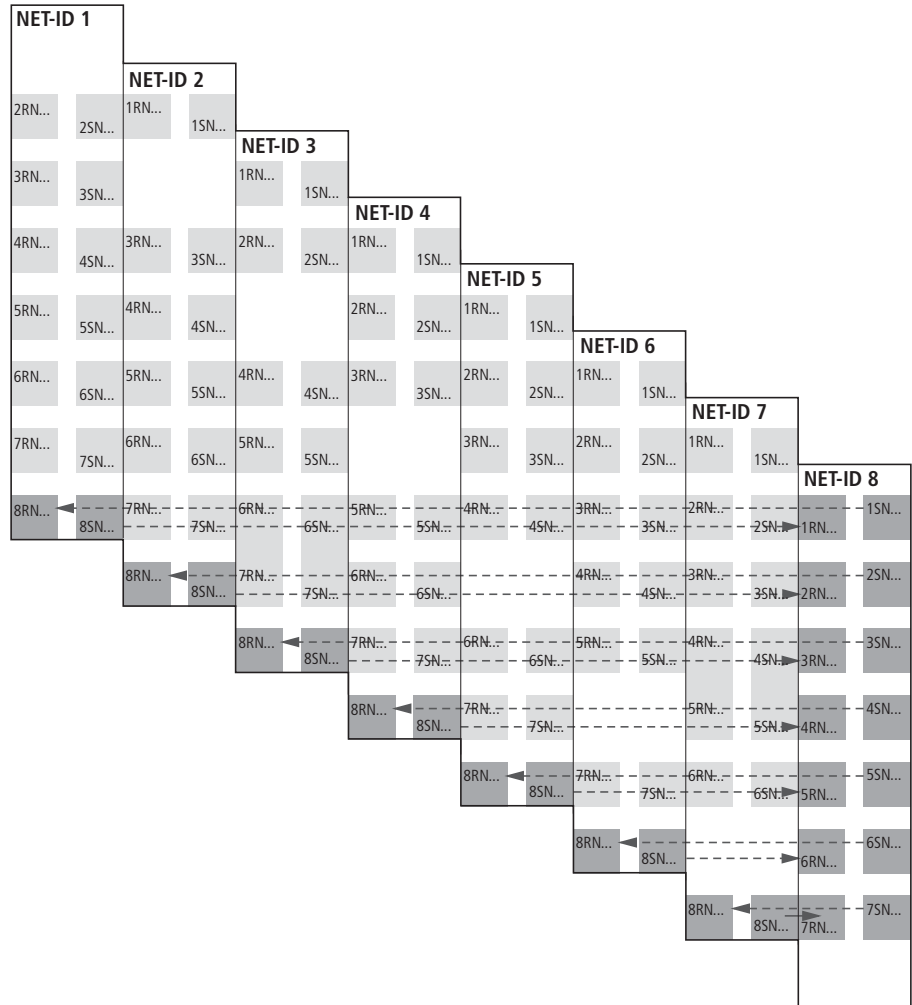

Figure 128: SN-RN combinations of NET station 8

4.7.15 SN-RN example

NET station 2 sends the status of the P button P01 via SN1 to NET station 1.

```
P 01-----c1SN01
```

On NET station 1 the status of P1 is associated via RN01 as a count pulse for the counter relay C01.

```
2RN01-----cC01C_
```

4 Wiring with MFD

4.8 Wiring COM-LINK operands in the circuit diagram

4.7.16 NET operand GT.. (receive), PT.. (send) and SC.. (set date and time)

The function blocks are of data type 32-bit. They only function if the NET is operating correctly (→ section "9.3 Diagnostics", page 479). More information about the function blocks → section "5 Function blocks", page 199

4.8 Wiring COM-LINK operands in the circuit diagram

Requirements for using COM-LINK operands: The COM-LINK connection between MFD-Titan and the remote station must be physically implemented, configured and activated (→ section "3.8 COM-LINK connection", page 132).

4.8.1 Operand access in the active MFD

If you access the operands of the remote device via the COM-LINK connection, the station number 1 must be added to the operands of this device in the program of the active MFD, e.g. 1 I3: means input 3 of the remote station.

Example: The active MFD queries input I3 of the remote device. The status is passed to marker M01 of the active MFD.

```
1 I 03-----[ M 01
```

You can read the following operand types from the remote station (READ):

1I, 1IA*), 1ID, 1Q, 1QA*)

* not with easySafety

If the remote device is connected with an expansion unit, you can also read its inputs/outputs (1R/1S).

If you are using an easySafety device as a remote device, you can also read its safety inputs/outputs IS../QS via 1 I.. and 1 Q.. operands. For COM-LINK operands with the fixed station number 1, the same IS../I.. and QS../Q assignment is used as for the NET operands. Refer to the operating manual of the easySafety ES4P.... control relay for information on how to complete the assignment.

You can read markers (READ) or write them (WRITE) from the marker range MD01 - MD20 of the remote device.



If the remote station does not have any analog inputs or outputs or no connected expansion unit, these COM-LINK operands are set to 0.

4.8 Wiring COM-LINK operands in the circuit diagram

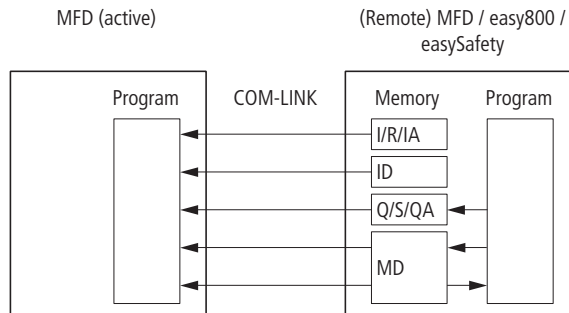

Figure 129: Access to operand ranges

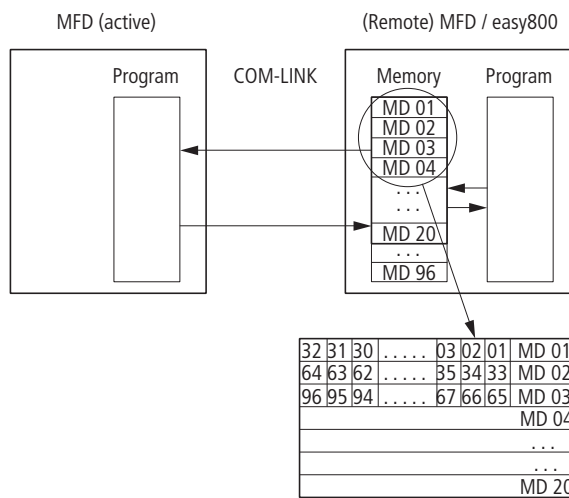

Figure 130: Access to the marker ranges

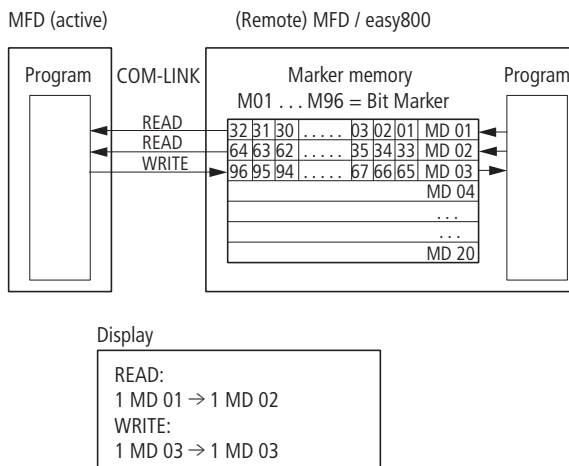

Figure 131: Bit marker range for reading and writing defined

4 Wiring with MFD

4.8 Wiring COM-LINK operands in the circuit diagram

If the active MFD is required to read and/or write some markers in the remote device, a marker range (READ) and/or (WRITE) must be parameterized first of all. Carry out the parameterization on the display/ keypad of the active device. Enter the start and the end of the marker range. Only marker double words are accepted as parameters.

Shows an example of assigned parameters → Figure 131, page 185: The READ range starts here at MD01 and ends at MD02. MD03 is defined as the WRITE range.

The remote device normally provides a marker range from MD01 to MD20. The entire range from MD01 to MD96 can be used in the program of the remote device!

Table 29: Operands of the remote station
* parameterized marker range (READ)/(WRITE)

Function	Operand	Range	Data type	Access R = Read W = Write
Remote input (basic device)				
easy800	1I	1 - 16	Bit	R
easySafety	1I	1 - 14	Bit	R
Remote input (expansion unit)	1R	1 - 16	Bit	R
Remote output (basic device)				
easy800	1Q	1 - 8	Bit	R
easySafety	1Q	1 - 7	Bit	R
Remote output (expansion unit)	1S	1 - 8	Bit	R
Analog input	1IA	1 - 4	32 Bit	R
Analog output	1QA	1	32 Bit	R
Diagnostics	ID 1	1 - 16	Bit	R
Bit marker	1M	1 - 96	Bit	R, W *
Byte markers	1MB	1 - 80	8 bit	R, W *
Word markers	1MW	1 - 40	16 bits	R, W *
Double word markers	1MD	1 - 20	32 Bit	R, W *

Table 29 shows the COM-LINK operands which can be accessed by the active MFD with the COM connection.

Some markers can be addressed as bit, byte, word or double word (→ also → Figure 131, page 185). All marker data types, also double words, are consistent!

4.8.1.1 Example: reading markers

The active MFD fetches a marker bit from the remote device. The following circuit diagram line is entered in the active MFD.

```
1M 03-----[ M 03
```

4.8.1.2 Example: writing markers

The active MFD writes a marker bit to the remote device. The following circuit diagram line is entered in the active MFD.

```
M 94-----[ 1M 08
```

4.8.2 Access method

The active MFD controls the data exchange. It reads or write the operands of the remote device cyclically. **120 ms** is a guide value for the time required for refreshing a marker double word.

Write/read operands via the COM-LINK connection run asynchronously to program accesses. This applies to the active MFD as well as to the remote device.

CAUTION

Due to these factors, the COM-LINK connection should not be used for control purposes but only for visualization tasks!

4.8.2.1 Operand access in the remote device

Both the active MFD-Titan and the remote device can write the markers of the remote device. In this type of dual access, the last entry is always valid.

CAUTION

Avoid double write accesses to the same markers!

Monitoring the COM-LINK connection → section "9.6 Monitoring the COM-LINK connection", page 483.

4.9 Working with function blocks

This chapter describes further on how to add and parameterize function blocks in the circuit diagram. A detailed description of all available function blocks is provided in the → Section "5 Function blocks" on page 199. The function blocks are presented there in alphabetical order. This section, however, describes some general notes on working with function blocks.

The function blocks are used to simulate some of the devices used in conventional open-loop and closed-loop control systems. The following applies to function blocks:



Current actual values are deleted when you switch off the power supply or switch the MFD device to STOP mode. Exception: Retentive data keeps its state (→ Section "8.2.7 Storing data retentively (Retention menu item...)", page 458).

The most recent actual values are transferred to the operands every cycle. The data function block is an exception.



If you want to prevent other people from modifying the parameters of the function blocks, change the access enable symbol from "+" to "-" when creating the circuit diagram and setting parameters. You can then protect the circuit diagram with a password.



As every function block in the function block list takes up memory, even if it is no longer being used and has been deleted in the circuit diagram, you should clear it occasionally. Check the function block diagram for any function blocks that are no longer required and delete them, → Section "4.9.4 Deleting function blocks", page 196.

CAUTION

The following applies to RUN mode: A MFD device processes the function block after a pass through the circuit diagram. This takes the last status of the coils into account.



The function blocks are designed so that an output value of a function block can be assigned directly with an input of another function block. The 32-bit data format is used automatically. This also enables the transfer of negative values.

4.9.1 Adding function blocks to the circuit diagram for the first time

Add a function block to the circuit diagram for the first time in the following way:

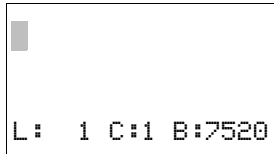

```
L: 1 C:1 B:7520
```

- ▶ Use the ^ v < > buttons to move the cursor to a free contact or coil field.
- ▶ Press OK so that the MFD device switches to entry mode.

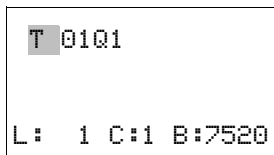

```
T 01Q1  
L: 1 C:1 B:7520
```

- ▶ Then use cursor buttons ^ v to select the required function block, e.g. timing relay using the T identifier.

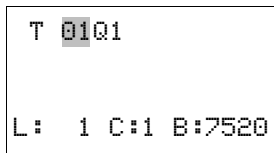

```
T 01Q1  
L: 1 C:1 B:7520
```

- ▶ When the function block identifier flashes, press OK or the cursor button > to move to the function block number and press OK.

The parameter dialog opens. You can only set Boolean basic parameters here for the standard function blocks. The entire parameterization is carried out in the function block editor. Further information on this is provided in the following chapter.

4.9.2 Setting function block parameters

Function blocks are simply called in the circuit diagram and also enter the Boolean basic parameters there. You assign actual value and setpoint parameters for the function block inputs and outputs via the FUNCTION RELAYS menu. You can of course also set the basic parameters in the function block editor and then add the function block in the circuit diagram as a contact or coil.

The edited function blocks are always part of the circuit diagram.

4 Wiring with MFD

4.9 Working with function blocks

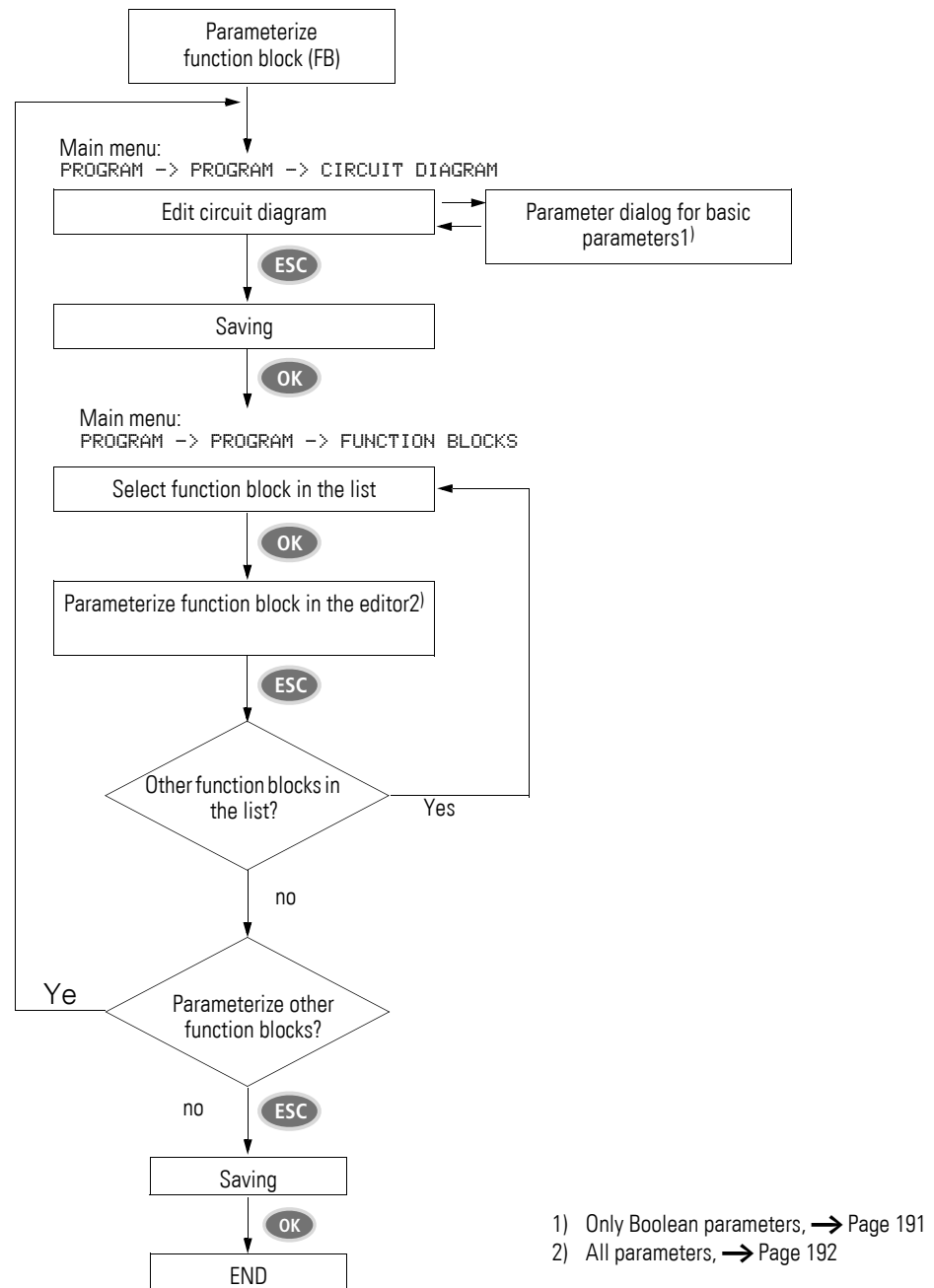

Figure 132: Overview of function block parameter assignment

4.9.2.1 Parameter assignment from the circuit diagram

When a function block is added for the first time, the parameter dialog is started automatically.

```
T 01 X? S +  
>I1  
>I2  
QU>
```

The figure on the left shows an example of a parameter dialog for a "timing relay" function block.

The parameter options available depend on the function block concerned. They cover the basic parameters of the first line up to the +/- character. The +/- symbol is used to switch the Parameter display on or off during RUN mode and thus allow (+) or block (-) the possibility to modify setpoints (constants). The +/- symbol must at least be confirmed with OK.



Parameter sets can only be enabled or protected via the FUNCTION RELAYS menu, or via the circuit diagram with the "+" enable and with "-" inhibit parameter set characters.

- ▶ Use the cursor buttons < > to select the parameter to be changed, for example the time range "S".
- ▶ Use the cursor buttons ^ v to change the parameter value to a different time range such as M:S.
- ▶ Press OK to exit the parameter dialog if you wish to save the parameters or press ESC, if you do not wish to parameterize the function block and add it to the circuit diagram.

After saving or canceling, the cursor returns to the position in the circuit diagram where you last left it.

To complete the parameter setting of the function block, such as the setting of setpoints, call up the function block editor in the following way:

- ▶ Press ESC in order to save the circuit diagram with the newly added function block.
- ▶ Answer the subsequent SAVE prompt with OK.

The circuit diagram is saved and the MFD device changes to the next higher menu level.

4 Wiring with MFD

4.9 Working with function blocks

4.9.2.2 Parameter setting in the function block editor

Open the function block editor via the FUNCTION BLOCKS menu. Then first enter the function block list in which the function blocks used are listed.

If no function blocks are shown, the list is empty.

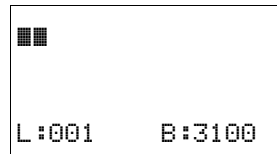

In our example, the list contains the function blocks AR, CP and T. The function blocks are created in the order in which they were edited.

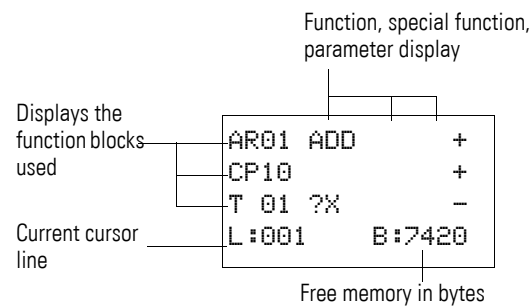
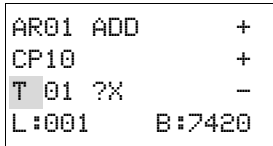

Figure 133: Explanation of the function block list



► Use the cursor buttons $\wedge \vee \langle \rangle$ to select the required function block from the function block list, in this case timing relay T01.

The timing relay is shown in the function block editor and can be fully assigned parameters here.

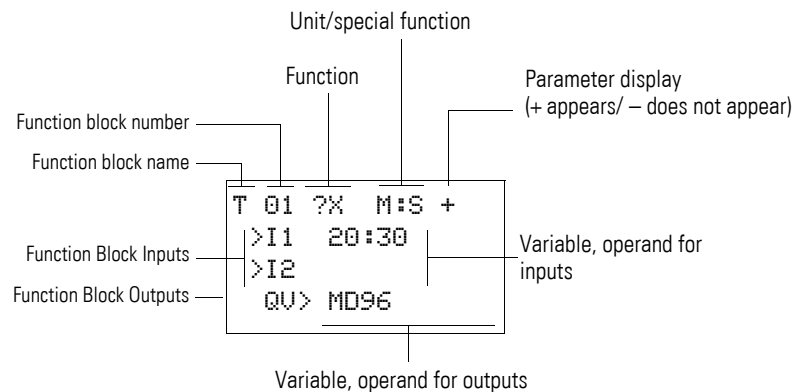

Figure 134: Display of the function blocks in the function block editor

```
T Q1 ?X M:S +
>I1 20:30
>I2
QV> MD96
```

Example: Timing relay function block

Function Block:	Timing Relay
Switch function:	On-delayed with random time
Time range:	M:S (Minute:Second)
Set time >I1:	20 min 30 s
Actual time QV>:	Copied to MD96

Assigning operands at the input of a function block

The following operands can be assigned to the input of a function block:

- Constants, e.g.: 42,
- Markers such as MD, MW, MB,
- Analog output QA,
- Analog inputs IA,
- All output variables of the function blocks ...QV>

CAUTION

When assigning the parameters of a function block input, ensure that these cannot be triggered with impermissible values during operation. There is a danger of this if you assign a variable that can assume negative values to a standard function block input that can only accept positive values.

If, for example, the "T - timing relay" is triggered with a negative time setpoint, it will no longer switch in the expected way.

You should therefore take care to exclude such situations, as the MFD device cannot foresee these when the parameters are assigned.

If, for example, you have set the output QV of the AR arithmetic function block at input I1 of the T function block, you should connect a CP comparator in between in order to signal the occurrence of a negative value.

In most applications, a thorough simulation is enough to prevent any impermissible values at the function block input.

4 Wiring with MFD

4.9 Working with function blocks

Assigning operands at the output of a function block

Markers such as MD, MW, MB or the analog output QA of the device can be assigned to the variable output QV of a function block.

Deleting operands on the function block inputs/outputs

Position the cursor on the required operand.

- ▶ Press the DEL pushbutton.

```
T 01 X? M:S +
>I1 ■■■:30
>I2
QU> MD96
```

The operand is deleted.

```
T 01 X? M:S +
>I1 ■■
>I2
QU> MD96
```

4.9.3 Changing function block parameters

A MFD device allows you to change the parameters of function blocks, such as the setpoints of timing or counter relays without calling up the circuit diagram. To change these parameters, the MFD device must be in RUN operating mode.

Parameters of the function blocks that you use in the standard circuit diagram can be changed with the following accesses:

- Access 1 - FUNCTION BLOCKS, STOP mode
All parameters can be set or deleted via PROGRAM -> FUNCTION BLOCKS and the function block editor.
- Access 2- FUNCTION BLOCKS menu, RUN mode
You reach the function block editor via PROGRAM -> FUNCTION BLOCKS. Here you can change setpoints (constants). This access is blocked if the program is password protected.
- Access 3- PARAMETERS menu option, RUN mode
Choose PARAMETERS to change the set values (constants). These modification options are also provided if you have saved the program and therefore password protected the function block editor. With the function blocks used you can use the +/- character to set which function blocks allow the changing of their parameters.

Access 1 - FUNCTION RELAYS, STOP mode

This access method is basically no different to the initial parameter assignment of a function block (→ Section "4.9.2.1 Parameter assignment from the circuit diagram", page 191).

Access 2 - FUNCTION RELAYS, RUN mode

Requirements for the parameter setting via FUNCTION BLOCKS:

- The function block is used in the standard circuit diagram or function block.
- Access to the parameter set is enabled, indicated by the +/- character at the top right of the display.

Proceed as follows to call the parameter dialog again for changes:

- ▶ Press OK to enter the main menu.
- ▶ Open the function block list via PROGRAM -> FUNCTION BLOCKS.

First enter the function block list. All function blocks used in the circuit diagram are displayed here.

```
T 03 U S +
CP08      -
C 17      +
L: 1      RUN
```

- ▶ Use ^ or v to select the required function block.
- ▶ Press OK.
- ▶ Scroll with the ^ or v cursor buttons through the constants of the function block inputs.
- ▶ Change the values for a parameter set:
 - OK: Switch to Entry mode.
 - < > Change decimal place.
 - ^ v Change value at a decimal place.
 - OK: Save constant immediately and exit the parameter display by pressing ESC.

ESC: Keep the previous setting and exit the parameter display.



It is only possible to change input values at function blocks if they are setpoints (constants).

Access 3- PARAMETERS menu, RUN mode

Requirements for parameter assignment via PARAMETERS:

- The MFD device is in RUN mode.
- The function block is used in the standard circuit diagram or function block.
- Access to the parameter set is enabled, indicated by the +/- character at the top right of the display.

Proceed as follows to call the parameter dialog again for changes:

- ▶ Press OK to enter the main menu.
- ▶ Open the function block list via PARAMETERS.

```
T 03 U S +
CP08      -
C 17      +
L: 1      RUN
```

All function blocks used in the circuit diagram are displayed in the function block list.

Proceed from here described in → section " Access 2 - FUNCTION RELAYS, RUN mode", page 195.

4 Wiring with MFD

4.9 Working with function blocks

4.9.4 Deleting function blocks

Requirement: The MFD device must be in STOP mode.

- ▶ Move the cursor in the circuit diagram to all the contact fields and the coil field in which the function block to be deleted is used and press DEL each time.

Deleting function blocks from the function block list

In order to prevent accidental deletion, a function block continues to be managed in the function block list, even if it was already removed in the circuit diagram. To delete the function block permanently and therefore to free up more memory, you must remove it from the function block list.

```
AR01 ADD      +
CP10          +
T 18 ?X      -
L:002      B:5430
```

- ▶ Open the function block list via PROGRAM -> FUNCTION BLOCKS.
- ▶ Select the function block to be deleted in the function block list, in this case CP10.
- ▶ Press the DEL pushbutton.

The function block is removed from the function block list.

- ▶ Press ESC in order to save the function block list with the deleted function block.
- ▶ Answer the subsequent SAVE prompt with OK.

4.9.5 Checking function blocks

Requirement for the check: The MFD device must be in RUN mode.

You can check function blocks via the function block editor.

Choose PROGRAM... -> FUNCTION BLOCKS to enter the function block list which shows the standard function blocks used.

- ▶ In the function block list select the required function block.

In this example, select the data block comparator AR01 in Adder mode.

```
AR01 ADD      +
CP10          +
T 18 ?X      -
L:001      RUN
```

- ▶ Press OK.

```
AR01 ADD      +
>I1  20056
>I2  1095
QV> 21151
```

Depending on the display selected the function block is shown with the actual values and the result, or with the set operands and constants.

Press the ALT pushbutton if you wish to switch from operand to actual value display or vice versa during the check of the standard function block.

The operand is displayed.

```
AR01 ADD      +
>I1  C 01QV>
>I2  1095
QV> MD 56
```

- >I1= Actual value, here from the output of the counter C 01
- >I2= Constant 1095.
- QV> = Marker double word MD56.

- ▶ Press the ALT pushbutton again (see also the following note).

```
ARQ1 ADD      +  
>I1  20056  
>I2  1095  
OU> 21151
```

The display changes again to the display of actual values and the result.



Press ALT to switch likewise to the display of the function blocks as well as the other contact and coil operands in the circuit diagram. You can use ALT to switch from full but only partial display to a compact display showing all contacts and coils on one circuit diagram line. Pressing ALT once more will switch you back to the original display.

- ▶ Press ESC to return to the function block list.
- ▶ To leave the check display, press ESC once more and press OK in answer to the subsequent CANCEL prompt.

4 Wiring with MFD

4.9 Working with function blocks

5 Function blocks

The following description of the function blocks is in alphabetical order.

5.1 A, analog value comparator/threshold value switch

An analog value comparator or threshold value switch is used, for example, to compare analog values or marker contents and switch when defined threshold values are reached.

MFD allows the use of up to 32 analog value comparators/threshold switches.

5.1.1 Function block inputs/outputs

Analog value comparator A1...A32		Boolean inputs/outputs		Parameters		Output value	
Contact		Coil		Input value			
Q1	1 if the selected actual value/ setpoint condition is fulfilled ①						
CY	Value range exceeded ②						
				I1	Comparison value 1 ③		
				F1	Gain factor for I1 (I1 = F1 * value) ④		
				I2	Comparison value 2 ⑤		
				F2	Gain factor for I2 (I2 = F2 * value) ⑥		
				OS	Offset for the value at I1, I1 OS = OS + actual value at I1 ⑦		
				HY	Switch hysteresis for value at I2 (value HY is used for both positive and negative hysteresis.) ⑧		

Read the description of the inputs/outputs in the legend points in column 1 of the following tables.

5 Function blocks

5.1 A, analog value comparator/threshold value switch

5.1.2 Wiring of the function block

You wire the "analog value comparator" function block in the circuit diagram with its contacts.

5.1.3 Contacts

A closed contact indicates:

Parameters	Function
① A ..Q1	Reaching of the comparison result, according to the selected operating mode GT, EQ or LT
② A ..CY	Value range exceeded

5.1.3.1 Example for function block analog value comparator

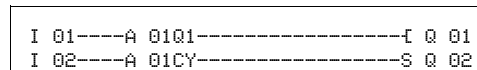

Figure 135: Wiring the contacts

5.1.4 Parametric programming of the function block inputs/outputs

5.1.4.1 Parameters

```
A 02 GT +
>I1
>F1
>I2
>F2
>OS
>HY
```

When using the function block in the circuit diagram for the first time, use OK to automatically enter the general display of function block parameters, as shown in the figure on the left. Enter the function block settings here. The display contains the following elements:

A 02	Function block analog value comparator number 02
GT	Operating mode: Greater than
+	Parameter display: Call enabled
③ >I1	Comparison value 1, is compared with the comparison value 2 at >I2, Value range: -2147483648 - 2147483647
④ >F1	Gain factor for >I1 (>I1 = >F1 x value) Value range: -2147483648 - 2147483647
⑤ >I2	Comparison value 2 I1, Value range: -2147483648 - 2147483647
⑥ >F2	Gain factor for >I2 (>I2 = >F2 x value) Value range: -2147483648 - 2147483647
⑦ >OS	Offset (zero point offset) for the value of >I1 Value range: -2147483648 - 2147483647
⑧ >HY	Positive and negative switching hysteresis for comparison value I2, Value range: -2147483648 - 2147483647

The parameter set consists of:

Operating Mode

This parameter defines which comparison result is to be used to close function block contact Q1.

Parameters	Function, parameterization in the function block
GT	>I1 greater than >I2
EQ	>I1 equal to >I2
LT	>I1 less than >I2

The factory setting of this parameter is LT.

Parameter Display

The display of the parameters during operation can be disabled. Additional information → section "4.9.2.1 Parameter assignment from the circuit diagram", page 191.

Parameters	Function
+	Parameters are displayed
-	Parameters are not displayed

This parameter is factory set to +.

Inputs

>I1 and >I2: The signals at function block inputs >I1 and >I2 are compared.

>F1 and >F2: If required adjust the comparison values and increase them by entering gain factors >F1 and >F2.

- >F1 is permanently assigned to >I1.
- >F2 is permanently assigned to >I2.

>OS: You can use the offset input >OS to move the zero point of the function block input >I1.

>HY: The >HY function block input is used for the positive and negative switching hysteresis of the input >I2.

All function block inputs can be assigned the following operands:

- Constant.
- Markers MD, MW, MB.
- Analog inputs IA01 to IA04:
 - IA01: Terminal I7.
 - IA02: Terminal I8.
 - IA03: Terminal I11.
 - IA04: Terminal I12.
- Analog output QA01.
- Output ...QV> of a different function block

5 Function blocks

5.1 A, analog value comparator/threshold value switch

If they are not associated, the inputs have a default value of:

- >F1 and >F2 = 1
- >OS and >HY = 0

Memory requirement

The analog value comparator function block requires 68 bytes of memory plus 4 bytes per constant at the function block inputs.

Cycle time [μs]

The execution time depends on the mode.

mode	Cycle time [μs]
GT	96
EQ	96
LT	96

5.1.5 Function of the function block

The function block compares values present at the inputs >I1 and >I2. You control the comparison in the function block by setting other input parameters:

- Multiplication factors >F1 and >F2 for the comparison values 1 and 2,
- Offset of comparison value 1 via function block input >OS,
- Application of a switch hysteresis to comparison value 2 on >HY.

Contact Q1 indicates the comparison result “greater”, “equal to” or “less” depending on the set operating mode.

Contact CY closes if the value range is exceeded. If an overshoot is indicated with CY = 1, Q1 stays 0. The following equations can be used to calculate the permissible value range.

$$- 2^{31} \leq I1 \times F1 + OS \leq (2^{31} - 1) \rightarrow CY = 0$$

$$- 2^{31} \leq I2 \times F2 + HY \leq (2^{31} - 1) \rightarrow CY = 0$$

$$- 2^{31} \leq I2 \times F2 - HY \leq (2^{31} - 1) \rightarrow CY = 0$$

The following signal diagram illustrates the function:

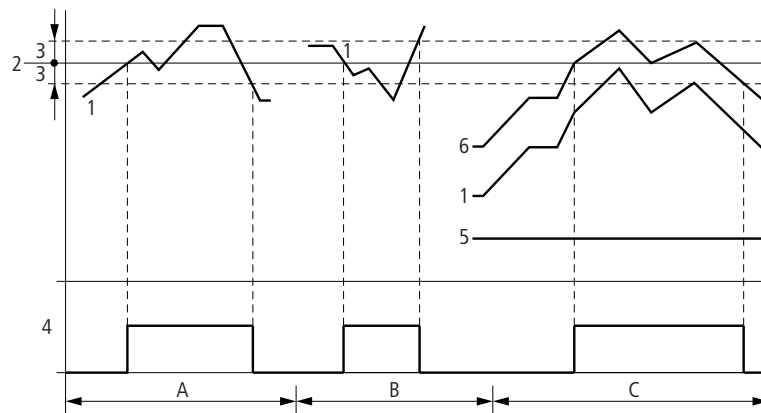

Figure 136: Signal diagram for analog value comparator

1: Actual value on >I1

2: Setpoint value on >I2

3: Hysteresis on >HY

4: Switch contact (N/O)

5: Offset for value >I1

6: Actual value plus offset

- Range A: Compare >I1 greater than >I2
 - The actual value >I1 increases.
 - The contact switches when the actual reaches the setpoint value.
 - The actual value changes and falls below the value of the setpoint value minus the hysteresis.
 - The contact goes to the normal position.
- Range B: Compare >I1 less than >I2
 - The actual value drops.
 - The contact switches if the actual value reaches the setpoint value.
 - The actual value changes and rises above the value of the setpoint value plus hysteresis.
 - The contact goes to the normal position.
- Range C: Compare >I1 greater than >I2 with offset
 - This example behaves as described in Range A. The offset value is added to the actual value.
- Comparison >I1 equals >I2
 - The contact switches on:
 - If I1 is equal to I2, i.e. the actual value is equal to the setpoint value.
 - The contact switches off:
 - If the hysteresis limit is exceeded with the actual value rising.
 - If the hysteresis limit is undershot with the actual value decreasing.

5.2 AR, Arithmetic

The Arithmetic function block performs all four basic calculations:

- add
- subtract
- multiply
- Divide.

MFD allows the use of up to 32 arithmetic function blocks.

5.2.1 Function block inputs/outputs

Arithmetic AR1...AR32 (ARithmetic)							
Boolean inputs/outputs				Parameters			
Contact		Coil		Input value		Output value	
CY	Outside of the permissible value range ①						
ZE	Calculation result QV is zero ②						
				I1	Value 1 ③		
				I2	Value 2 ④		
						QV	Calculation result ⑤

Read the description of the inputs/outputs in the legend points in the following tables.

5.2.2 Wiring of the function block

An arithmetic function block does not require an enable or start signal and is therefore not wired in a coil field of the standard circuit diagram. The function block is provided with the two Boolean outputs mentioned above for controlling the calculation result that you wire as contacts in the circuit diagram.

5.2.2.1 Contacts

A closed contact indicates:

Parameters	Function, parameterization in the function block
① AR..CY	Outside of the permissible value range
② AR..ZE	Result at output QV> is zero

5.2.2.2 Example of an arithmetic function block

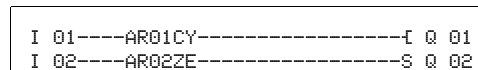

Figure 137: Wiring the function block contacts

5.2.3 Parametric programming of the function block inputs/outputs

5.2.3.1 Parameters

```
AR04 ADD +
>I1
>I2
QU>
```

When using the function block in the circuit diagram for the first time, use OK to automatically enter the general display of function block parameters, as shown in the figure on the left. Enter the function block settings here. The display contains the following elements:

AR04	Function block: Arithmetic, number 04
ADD	Mode: Add
+	Parameter display: Call enabled
③ >I1	First value is associated with the value at I2 via the arithmetic operation, value range: -2147483648 - 2147483647
④ >I2	Second value, -2147483648 - 2147483647
⑤ QU>	Outputs the calculation result, value range: -2147483648 - +2147483647

The parameter set consists of:

Operating Mode

This parameter is used to set the arithmetic operation required.

Parameter s	Function, parameterization in the function block
ADD	Addition of summand value >I1 plus Summand >I2
SUB	Subtraction of minuend >I1 minus Subtrahend >I2
MUL	Multiplication of factor >I1 by factor >I2
DIV	Division of dividend >I1 by divisor >I2

The factory setting of this parameter is ADD.

Parameter Display

The display of the parameters during operation can be disabled. Additional information → section "4.9.2.1 Parameter assignment from the circuit diagram", page 191.

Parameter s	Function
+	Parameters are displayed
-	Parameters are not displayed

This parameter is factory set to +.

Inputs

>I1 and >I2: The signals present at the inputs >I1 and >I2 are associated with the operation set as the operating mode.

You can assign the following operands to function block inputs >I1 and >I2:

5 Function blocks

5.2 AR, Arithmetic

- Constant.
- Markers MD, MW, MB.
- Analog inputs IA01 to IA04:
 - IA01: Terminal I7.
 - IA02: Terminal I8.
 - IA03: Terminal I11.
 - IA04: Terminal I12.
- Analog output QA01.
- Output ...QV> of a different function block.

Output

The output provides the calculation result as an integer. You can assign the following operands to output ...QV>:

- Analog output QA01
- Markers MD, MW, MB and DWord inputs of other function blocks.

Memory requirement of the function block

The arithmetic function block requires 40 bytes of memory plus 4 bytes per constant at the function block inputs.

Cycle time

The execution time depends on the mode.

mode	Cycle time [μs]
ADD	32
SUB	33
MUL	38
DIV	41

5.2.4 Function of the function block

The values present at the inputs >I1 and >I2 are associated with the arithmetic operation set as the mode.

If the calculation result exceeds the value range that can be represented, the overflow signal contact CY closes and output QV> contains the value of the last valid operation.

When the function block is called for the first time, the value at output QV> equals zero.

The following examples illustrate the functions of the function block for every arithmetic operation:

5.2.4.1 Addition examples

- $42 + 1000 = 1042$
- $2147483647 + 1 =$ Last valid value before this arithmetic operation, due to overflow (CARRY) AR..CY = Status 1
- $-2048 + 1000 = -1048$

5.2.4.2 Subtraction examples

- $1134 - 42 = 1092$
- $-2147483648 - 3 =$ Last valid value before this arithmetic operation, due to overflow (CARRY) AR..CY = Status 1
- $-4096 - 1000 = -5096$
- $-4096 - (-1000) = -3096$

5.2.4.3 Multiplication examples

- $12 \times 12 = 144$
- $1000042 \times 2401 =$ Last valid value before this arithmetic operation, due to overflow (CARRY) Correct value = 2401100842 AR..CY = Status 1
- $-1000 \times 10 = -10000$

5.2.4.4 Division examples

- $1024 : 256 = 4$
- $1024 : 35 = 29$ (The places after the decimal point are omitted.)
- $1024 : 0 =$ Last valid value before this arithmetic operation, due to overflow (CARRY) (mathematically correct "Infinity") AR..CY = Status 1
- $-1000 : 10 = -100$
- $1000 : -10 = -100$
- $-1000 : (-10) = 100$
- $10 : 100 = 0$

5 Function blocks

5.3 BC, data block comparator

5.3 BC, data block comparator

The data block comparator (BC = Block Compare) function block compares two contiguous marker ranges. For this you define the number of bytes to be compared. The comparison is carried out in byte format for marker types MB, MW and MD.

MFD device allows the use of up to 32 data data block comparators.

5.3.1 Function block inputs/outputs

Data block comparator BC1...BC32 (Block Compare)			
Boolean inputs/outputs		Parameters	
Contact	Coil	Input value	Output value
EQ			
E1			
E2			
E3			
	EN		
		I1	
		I2	
		NO	

Read the description of the inputs/outputs in the legend points in the following tables.

5.3.2 Wiring of the function block

You wire the function block in the circuit diagram with its enable coil and its contacts.

5.3.2.1 Coil

The coil of the function block is used in the circuit diagram.

Parameter	Function
⑤ BC...EN	Selective activation of the function block

5.3.2.2 Contacts

The contacts of the function block are evaluated in the circuit diagram. A closed contact indicates:

Parameters	Function
① BC..EQ	Compared ranges are identical;
② BC..E1	The number of compared elements for a marker range are exceeded.
③ BC..E2	Compared ranges overlap
④ BC..E3	Offset of compared blocks outside of the permitted range.

5.3.2.3 Example of a function block for comparing data blocks:

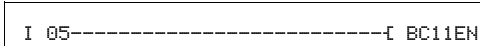
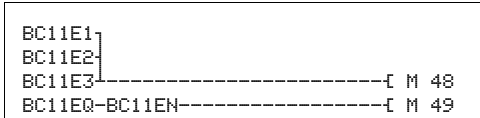

Figure 138: Wiring the enable coil

Figure 139: Wiring the contacts



5.3.3 Parametric programming of the function block inputs/outputs

5.3.3.1 Parameters

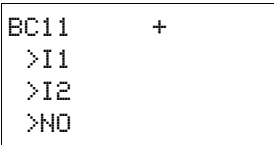

When using the function block in the circuit diagram for the first time, use OK to automatically enter the general display of function block parameters, as shown in the figure on the left. Enter the function block settings here. The display contains the following elements:

BC11	Function block: Data block comparator, number 11
+	Parameter display: Call enabled
⑥ >I1	Start of comparison range 1; the data block with the start address present at input I1 is compared with the data block with the start address present at input I2.
>I2	Start of comparison range 2
⑦ >NO	Number of elements to be compared in bytes per range, number: 1 - 383

The parameter set consists of:

5 Function blocks

5.3 BC, data block comparator

Parameter Display

The display of the parameters during operation can be disabled. Additional information → section "4.9.2.1 Parameter assignment from the circuit diagram", page 191.

Parameters	Function
+	Parameters are displayed
-	Parameters are not displayed

This parameter is factory set to +.

Inputs

The marker ranges corresponding to the start addresses specified on inputs >I1 and >I2 are compared with each other.

The function block inputs >I1, >I2 and >NO can have the following operands:

- Constant.
- Markers MD, MW, MB.
- Analog inputs IA01 to IA04:
 - IA01: Terminal I7.
 - IA02: Terminal I8.
 - IA03: Terminal I11.
 - IA04: Terminal I12.
- Analog output QA01.
- Output ...QV> of a different function block.

5.3.3.2 Specifying the marker range

Marker ranges can be specified with or without an offset.

Marker range without offset

If MB, MW or MD markers are specified at both >I1 and >I2 the number of the markers is the start of comparison range.

Marker range with offset

If you wish to work with an offset, specify one of the following variables at function block input >I1 or >I2:

- Analog input IA..,
- Analog output QA..,
- Constant.
- Output ..QV> of a function block.

The value at the input is taken as the offset to marker byte MB01.

Example:

A value 0 at input I1 means that the reference data block for the comparison starts at MB01. A value 100 at I2 means that the destination data block for the comparison starts at MB101.



The offset definition enables you to address the marker ranges (e.g. MB380) that you cannot address when using marker operands (direct addressing).

Offset calculation for addressing marker words:

$$\text{Offset} = \text{MW} (x - 1) \times 2$$

Offset calculation for addressing marker double words:

$$\text{Offset} = \text{MD} (x - 1) \times 4$$

5.3.3.3 Memory requirement

The data comparator function block requires 48 bytes of memory plus 4 bytes per constant at the function block inputs.

5.3.3.4 Cycle time

The execution time depends on the data volume.

mode	Cycle time [μs]
-	1 Byte 52 10 Byte 60 100 Byte 138

5.3.4 Function of the function block

The data block comparator function block compares two contiguous data blocks.

The comparator is active if coil BC..EN (enable) is triggered.



No data blocks are compared if an error is present.

The error outputs E1, E2 and E3 are evaluated regardless of the status of the enable.

5 Function blocks

5.3 BC, data block comparator

5.3.4.1 Example 1: Comparison of marker blocks, direct definition of marker ranges

Two marker blocks are to be compared. Block 1 starts at MB10, Block 2 starts at MB40. Each block is 10 bytes long.

- Parameters of function block BC01:
 - Comparison range 1: >I1 MB10
 - Comparison range 2: >I2 MB40
 - Number of bytes: >NO 10

Comparison range 1	Value of marker range 1 (decimal)	Comparison range 2	Value of marker range 2 (decimal)
MB10	39	MB40	39
MB11	56	MB41	56
MB12	88	MB42	88
MB13	57	MB43	57
MB14	123	MB44	123
MB15	55	MB45	55
MB16	134	MB46	134
MB17	49	MB47	49
MB18	194	MB48	194
MB19	213	MB49	213

The comparison result of the function block BC01 is: BC01EQ = 1, the data block ranges have the same content.

5.3.4.2 Example 2: Comparison of marker blocks, definition of a marker range with offset

Two marker blocks are to be compared. Block 1 starts at MB15, Block 2 starts at MB65. Each block is 4 bytes long.

- Parameters of function block BC01:
 - Comparison range 1: >I1 MB15
 - Comparison range 2: >I2 64
 - Number of bytes: >NO 4
 - Marker MB01: 1



Comparison range 2: Constant 64:
MB01 plus offset: $1 + 64 = 65 \rightarrow$ MB65.

Comparison range 1	Value of marker range 1 (decimal)	Comparison range 2	Value of marker range 2 (decimal)
MB15	45	MB65	45
MB16	62	MB66	62
MB17	102	MB67	102
MB18	65	MB68	57

The comparison result of the function block BC01 is: BC01EQ = 0, the data block ranges do not have the same content. MB18 and MB68 are not identical.

5.3.4.3 Example 3: Comparison of marker blocks, definition of a marker range in a different format.

Two marker blocks are to be compared. Block 1 starts at MB60, Block 2 starts at MD80. Each block is 6 bytes long.

- Parameters of function block BC01:
 - Comparison range 1: >I1 MB60
 - Comparison range 2: >I2 MD80
 - Number of bytes: >NO 6



The comparison is in byte format. MD80 has 4 bytes. Therefore the first two bytes of MD81 are also compared.

Comparison range 1	Value of marker range 1 (decimal/binary)	Comparison range 2	Value of marker range 2 (decimal/binary)
MB60	45/ 00101101	MD80 (Byte 1, LSB)	1097219629/ 01000001011001100011111000101101
MB61	62/ 00111110	MD80 (Byte 2)	1097219629/ 01000001011001100011111000101101
MB62	102/ 01100110	MD80 (Byte 3)	1097219629/ 01000001011001100011111000101101
MB63	65/ 01000001	MD80 (Byte 4, MSB)	1097219629/ 01000001011001100011111000101101
MB64	173/ 10101101	MD81 (Byte 1, LSB)	15277/ 0011101110101101
MB65	59/ 00111011	MD81 (Byte 2)	15277/ 0000100010101101

The data block ranges do not have the same content. BC01EQ = 0, MB65 and MD81 (Byte 2) are not identical.

5 Function blocks

5.3 BC, data block comparator

5.3.4.4 Example 4: Comparison of marker blocks, range violation error.

Two marker blocks are to be compared. Block 1 starts at MD60, Block 2 starts at MD90. Each block is 30 bytes long.

- Parameters of function block BC01:
 - Comparison range 1: >I1 MD60
 - Comparison range 2: >I2 MD90
 - Number of bytes: >NO 30



The comparison is in byte format. MD90 to MD96 is 28 bytes. The number of bytes is 30 bytes.

The error message "Number of comparison elements exceeds one of the comparison ranges" is output.

BC01E1 is 1.

5.3.4.5 Example 5: Comparison of marker blocks, range overlap error.

Two marker blocks are to be compared. Block 1 starts at MW60, Block 2 starts at MW64. Each block is 12 bytes.

- Parameters of function block BC01:
 - Comparison range 1: >I1 MW60
 - Comparison range 2: >I2 MW64
 - Number of bytes: >NO 12



The comparison is in byte format. MW60 to MW64 is 8 bytes. The number of bytes is 12 bytes.

The error message "Comparison ranges overlap" is output.

BC01E2 is 1.

5.3.4.6 Example 6: Comparison of marker blocks, invalid offset error.

Two marker blocks are to be compared. Block 1 starts at MW40, block 2 at MW54. The block length is determined by the value of counter C 01QV.

- Parameters of function block BC01:
 - Comparison range 1: >I1 MW40
 - Comparison range 2: >I2 MW54
 - Number of bytes: >NO C 01QV



The value of C 01QV is 1024. This value is too big. The value at >NO can be between 1 and +383.

The error message "The specified offset of the comparison ranges is outside of the permissible range" is output.

BC01E3 is 1.

5 Function blocks

5.4 BT, Data block Transformer

5.4 BT, Data block Transformer

The block transfer function block (BT) is used for transferring values from one marker range to another (copy data). The marker ranges can be overwritten with a particular value (data initialization). The following marker ranges can be transferred and written:

- MB.
- MW.
- MD.

MFD device allows the use of up to 32 data block transfer function blocks.

5.4.1 Function block inputs/outputs

Data block comparator BT1...BT32 (Block Transfers)							
Boolean inputs/outputs				Parameters			
Contact		Coil		Input value		Output value	
E1	Error 1 ①						
E2	Error 2 ②						
E3	Error 3 ③						
		EN	Activate transfer ④				
				I1	Source range start ⑤		
				I2	Destination range start ⑤		
				NO	Number of elements ⑥		

Read the description of the inputs/outputs in the legend points in the following tables.

5.4.2 Wiring of the function block

You wire the function block in the circuit diagram with its trigger coil and its contacts.

5.4.2.1 Coil

The coil of the function block is used in the circuit diagram to transfer the input value.

Parameters	Function
④ BT...T_	Triggering the transfer on a rising edge

5.4.2.2 Contacts

A closed contact indicates:

	Parameters	Function
①	BT..E1	Outside of source or destination range
②	BT..E2	Overlapping of source and destination range
③	BT..E3	Invalid offset

5.4.2.3 Example of a block transfer function block:

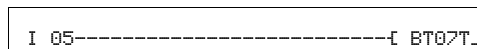

Figure 140: Wiring the trigger coil

The trigger coil is connected to a device input.

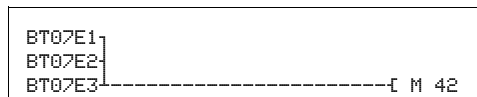
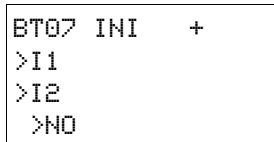

Figure 141: Wiring the contacts

The messages of the function block are sent as a group message to a marker.

5.4.3 Parametric programming of the function block inputs/outputs

5.4.3.1 Parameters



When using the function block in the circuit diagram for the first time, use OK to automatically enter the general display of function block parameters, as shown in the figure on the left. Enter the function block settings here. The display contains the following elements:

BT07	Function block: Data block transfer, number 07
INI	Operating mode: INI
+	Parameter display: Call enabled
⑤ >I1	Start of source range or initialization markers (MB,MW,MD)
>I2	Destination range start
⑥ >NO	Number of elements to be written in bytes per range, number: 1 - 383

The parameter set consists of:

5 Function blocks

5.4 BT, Data block Transformer

Operating Mode

The operating mode setting defines whether marker ranges are to be copied or initialized.

Parameters	Function
INI	Initialize marker ranges
CPY	Copy marker ranges

This parameter is factory set to INI.

Parameter Display

The display of the parameters during operation can be disabled. Additional information → section "4.9.2.1 Parameter assignment from the circuit diagram", page 191.

Parameters	Function
+	Parameters are displayed
-	Parameters are not displayed

This parameter is factory set to +.

Inputs

>I1 and >I2: Function block inputs >I1 and >I2 are used to define the beginning of the source and destination range.

The entry at function block input >NO determines the number of elements to be written.

You can assign the following operands to function block inputs >I1 and >I2 and >NO:

- Constant.
- Markers MD, MW, MB.
- Analog inputs IA01 to IA04:
 - IA01: Terminal I7.
 - IA02: Terminal I8.
 - IA03: Terminal I11.
 - IA04: Terminal I12.
- Analog output QA01.
- Output ...QV> of a different function block.

5.4.3.2 Specifying the marker range

Marker ranges can be specified with or without an offset.

Marker range without offset

If MB, MW or MD markers are specified at both >I1 and >I2 the number of the markers is the start of comparison range.

Marker range with offset

If you wish to work with an offset, specify one of the following variables at function block input >I1 or >I2.

- Analog input IA..
- Analog output QA..
- Constant.
- Output ..QV of a function block.

The value at the input is taken as the offset to marker byte MB01.



The offset definition enables you to address the marker ranges (e.g. MB380) that you cannot address when using marker operands (direct addressing).

Offset calculation for addressing marker words:

$$\text{Offset} = \text{MW} (x - 1) \times 2$$

Offset calculation for addressing marker double words:

$$\text{Offset} = \text{MD} (x - 1) \times 4.$$

5.4.3.3 Memory requirement

The transfer data block function block requires 48 bytes of memory plus 4 bytes per constant at the function block inputs.

5.4.3.4 Cycle time

The execution time depends on the data volume.

mode	Cycle time [μs]
INI/CPY	1 Byte 54 10 Byte 60 100 Byte 71

5.4.4 Function of the function block

The transfer data block function block has two operating modes.



No data blocks are initialized or copied in the event of an error.

Initializing INI marker ranges

There is one source range and one destination range. The source range is specified at >I1. The length of the source range is one byte. The destination range is specified at >I2. The length of the destination range is specified by the number of bytes at the >NO input.

The content of the source range is transferred to the marker bytes in the destination range.

The function block carries out a transfer on a rising edge at coil T_ (Trigger).

The error contacts E1, E2 and E3 are evaluated regardless of the status of the trigger.

Example 1: Initializing marker blocks, direct definition marker ranges

The value of marker byte 10 is to be transferred to marker bytes 20 to 29.

- Parameters of function block BT01:
 - Source range: >I1 MB10
 - Target range: >I2 MB20
 - Number of bytes: >NO 10

Sourcerange	Value of source marker range (decimal)	Destination range	Value of destination marker range (decimal)
MB10	123	MB20	123
		MB21	123
		MB22	123
		MB23	123
		MB24	123
		MB25	123
		MB26	123
		MB27	123
		MB28	123
		MB29	123

After a rising edge from 0 to 1 at coil BT01T_ the value 123 is present in the marker bytes MB20 to MB29.

Example 2: Initialization of marker blocks, definition of a range with offset
The content of marker byte MB15 is to be transferred to marker bytes MB65 to MB68.

- Parameters of function block BT01:
 - Source range: >I1 MB15
 - Target range: >I2 64
 - Number of bytes: >NO 4
 - Marker MB01: 1



Destination range: Constant 64:
Marker MB01 plus offset: $1 + 64 = 65 \rightarrow$ MB65.

Source range	Value of source marker range (decimal)	Destination range	Value of destination marker range (decimal)
MB15	45	MB65	45
		MB66	45
		MB67	45
		MB68	45

After a rising edge from 0 to 1 at coil BT01T_ the value 45 is present in the marker bytes MB65 to MB68.

5 Function blocks

5.4 BT, Data block Transformer

Example 3: Initialization of marker blocks, transfer of a range to a different format.

The value of marker byte MB60 is to be transferred to MD80 and MD81.

- Parameters of function block BT01:
 - Source range: >I1 MB60
 - Target range: >I2 MD80
 - Number of bytes: >NO 8



The transfer is in byte format. MD80 has 4 bytes and MD81 has 4 bytes, which means that >NO has the value 8.

Comparison range 1	Value marker range 1 (dec./binary)	Comparison range 2	Value of marker range 2 (decimal/binary)
MB60	45/ 00101101	MD80 (Byte 1, LSB)	757935405/ 00101101001011010010110100101101
		MD80 (Byte 2)	757935405/ 00101101001011010010110100101101
		MD80 (Byte 3)	757935405/ 00101101001011010010110100101101
		MD80 (Byte 4, MSB)	757935405/ 00101101001011010010110100101101
		MD81 (Byte 1, LSB)	757935405/ 00101101001011010010110100101101
		MD81 (Byte 2)	757935405/ 00101101001011010010110100101101
		MD81 (Byte 3)	757935405/ 00101100010110110010110100101101
		MD81 (Byte 4, MSB)	757935405/ 00101101001011010010110100101101

After a rising edge from 0 to 1 at coil BT01T_ the value 757935405 is present in the marker double words MD80 and MD81.

Example 4: Transfer of marker byte, destination range violation error.

The value of marker byte MB96 is to be transferred to MD93, MD94, MD95 and MD96. The length is 16 bytes.

- Parameters of function block BT01:
 - Source range: >I1 MD96
 - Target range: >I2 MD93
 - Number of bytes: >NO 18



The transfer is in byte format. MD93 to MD96 is 16 bytes. 18 bytes were incorrectly defined as length.

The error message "Number of elements exceeds the destination range" is output.

BT01E1 is 1.

Example 5: Transfer of marker bytes, invalid offset error.

The value of marker byte MB40 is to be transferred to MW54 and subsequent marker words. The block length is specified by the value of the counter C 01QV.

- Source range: >I1 MB40
- Target range: >I2 MW54
- Number of bytes: >NO C 01QV



The value of C 01QV is 788. This value is too big. The value at >NO can be between 1 and +192.

The message "The specified offset of the destination range is outside of the permissible range" is output.

BT01E3 is 1.

5 Function blocks

5.4 BT, Data block Transformer

CPY mode, copy marker ranges

There is one source range and one destination range. The source range is specified at >I1. The destination range is specified at >I2. The length of the destination range is specified by the number of bytes at the >NO input.

The content of the source range is copied to the marker bytes in the destination range.

The function block executes the copy operation if there is a rising edge from 0 to 1 at the BT..T_ (Trigger) coil.

The error outputs E1, E2 and E3 are evaluated regardless of the status of the trigger.

Example 1: Copy of marker blocks, direct definition of marker ranges

The value of marker byte 10 to 19 is to be transferred to marker bytes 20 to 29.

- Parameters of function block BT01:
 - Source range: >I1 MB10
 - Target range: >I2 MB20
 - Number of bytes: >NO 10

Source range	Value of source marker range (decimal)	Destination range	Value of destination marker range (decimal)
MB10	42	MB20	42
MB11	27	MB21	27
MB12	179	MB22	179
MB13	205	MB23	205
MB14	253	MB24	253
MB15	17	MB25	17
MB16	4	MB26	4
MB17	47	MB27	47
MB18	11	MB28	11
MB19	193	MB29	193

After a rising edge from 0 to 1 at coil BT01T_ the content of MB10 to MB19 is copied to the marker bytes MB20 to MB29.

Example 2: Copying of marker blocks, definition of a range with offset

The content of marker bytes MB15 to MB18 is to be copied to marker bytes MB65 to MB68.

- Parameters of function block BT01:
 - Source range: >I1 MB15
 - Target range: >I2 64
 - Number of bytes: >NO 4
 - Marker MB01: 1



Destination range: Constant 64:
Marker MB01 plus offset: $1 + 64 = 65 \rightarrow$ MB65.

Source range	Value of source marker range (decimal)	Destination range	Value of destination marker range (decimal)
MB15	68	MB65	68
MB16	189	MB66	189
MB17	203	MB67	203
MB18	3	MB68	3

After a rising edge from 0 to 1 at coil BT01T_ the content of MB15 to MB18 is copied to the marker bytes MB65 to MB68.

Example 3: Copying of marker blocks, definition of a range in a different format

Marker range MD60 to MD62 is to be copied to MW40 to MW45.

- Parameters of function block BT01:
 - Source range: >I1 MD60
 - Target range: >I2 MW40
 - Number of bytes: >NO 12



The transfer is in byte format. 12 bytes are to be copied.
The range MD60 to MD62 is 12 bytes. This is copied to the range MW40 to MW45.

5 Function blocks

5.4 BT, Data block Transformer

Comparison range 1	Value of marker range 1 (decimal/binary)	Comparison range 2	Value of marker range 2 (decimal/binary)
MD60	866143319/ 0011001110100000 0100110001010111	MW40 (LSW)	19543/0011001110100000 0100110001010111
MD60	866143319/ 0011001110100000 0100110001010111	MW41 (MSW)	13216/0011001110100000 0100110001010111
MD61	173304101/0000101001010100 0110100100100101	MW42 (LSW)	26917/0000101001010100 0110100100100101
MD61	173304101/0000101001010100 0110100100100101	MB43 (MSW)	2644/0000101001010100 0110100100100101
MD62	982644150/ 0011101010010001 1111010110110110	MB44 (LSW)	62902/0011101010010001 1111010110110110
MD62	982644150/0011101010010001 1111010110110110	MB45 (MSW)	14993/0011101010010001 1111010110110110

After a rising edge from 0 to 1 at coil BT01T_ the values are copied to the appropriate range.

Example 4: Copying of marker bytes, destination range violation error

Marker range MB81 to MB96 is to be transferred to MD93 to MD96. The length is 16 bytes.

- Parameters of function block BT01:
 - Source range: >I1 MB81
 - Target range: >I2 MD93
 - Number of bytes: >NO 18



The transfer is in byte format. MD93 to MD96 is 16 bytes. 18 bytes were incorrectly defined as length.

The error message “Number of elements exceeds the destination range” is output.

BT01E1 is 1.

Example 5: Comparison of marker blocks, range overlap error

12 bytes are to be copied starting from MW60. MW64 is specified as destination address.

- Parameters of function block BT01:
 - Source range: >I1 MW60
 - Target range: >I2 MW64
 - Number of bytes: >NO 12



The copy operation is in byte format. MW60 to MW64 is 8 bytes. The number of bytes is 12 bytes.

The error message "Both ranges overlap" is output.

BT01E2 is 1.

Example 6: Copying of marker bytes, invalid offset error.

The value of marker word MW40 is to be copied to MW54 and subsequent marker words. The block length is specified by the value of the counter C 01QV.

- Parameters of function block BT01:
 - Source range: >I1 MM40
 - Target range: >I2 MW54
 - Number of bytes: >NO C 01QV



The value of C 01QV is 10042. This value is too big. The value at >NO can be between 1 and +383.

The message "The specified offset of the destination range is outside of the permissible range" is output.

BT01E3 is 1.

5.5 BV, Boolean operation

The function block enables the values to be combined in Boolean (logic) operations. It has the following functions:

- Masking out of particular bits from values,
- Bit pattern recognition,
- Bit pattern modification.

MFD device allows the use of up to 32 Boolean operations.

5.5.1 Function block inputs/outputs

Boolean operation BV1...BV32 (Boolean operation)							
Boolean inputs/outputs				Parameters			
Contact		Coil		Input value		Output value	
ZE	Result at output QV is zero ①						
				I1	Value 1 ②		
				I2	Value 2 ②		
						Q V	Operation result ③

Read the description of the inputs/outputs in the legend points in the following tables.

5.5.2 Wiring of the function block

You wire the function block in the circuit diagram with its contact.

5.5.2.1 Contact

A closed contact indicates:

Parameters	Function, parameterization in the function block
① BV...ZE	Result at output QV> is zero

5.5.2.2 Example of a function block for Boolean operation:

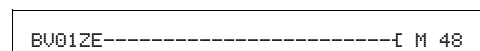

Figure 142: Wiring of the contact to marker

5.5.3 Parametric programming of the function block inputs/outputs

5.5.3.1 Parameters

```
BV01 AND +
>I1
>I2
QV>
```

When using the function block in the circuit diagram for the first time, use OK to automatically enter the general display of function block parameters, as shown in the figure on the left. Enter the function block settings here. The display contains the following elements:

BV01	Function block: Boolean operation, number 01
AND	Operating mode: AND
+	Parameter display: Call enabled
② >I1	First value (32-bit), the data block at this input is associated with the value at I2
>I2	Second value: (32-bit)
③ QV>	Result of the operation (32 Bit)

The parameter set consists of:

Operating Mode

This parameter is used to set the type of operation required.

Parameters	Function
AND	AND operation
OR	OR operation
XOR	Exclusive OR operation
NOT	Negation of the Boolean value of >I1

The factory setting of this parameter is AND.

Parameter Display

The display of the parameters during operation can be disabled. Additional information → section "4.9.2.1 Parameter assignment from the circuit diagram", page 191.

Parameters	Function
+	Parameters are displayed
-	Parameters are not displayed

This parameter is factory set to +.

5.5.4.1 AND Boolean operation

Value >I1: 13219_{dec} = 0011001110100011_{bin}
Value >I2: 57193_{dec} = 1101111101101001_{bin}
Result QV>: 4897_{dec} = 0001001100100001_{bin}

5.5.4.2 OR Boolean operation

Value >I1: 13219_{dec} = 0011001110100011_{bin}
Value >I2: 57193_{dec} = 1101111101101001_{bin}
Result QV>: 65515_{dec} = 1111111111101011_{bin}

5.5.4.3 XOR Boolean operation

Value >I1: 13219_{dec} =
0011001110100011_{bin}
Value >I2: 57193_{dec} =
1101111101101001_{bin}
Result QV>: 60618_{dec} =
1110110011001010_{bin}

5.5.4.4 NOT Boolean operation

Value >I1: 13219_{dec} = 00000000000000000011001110100011_{bin}
Value >I2: omitted
Result QV>: -13220_{dec} = 11111111111111111100110001011100_{bin}

The NOT sequence operates according to the following rules:

>I1, positive value

Subtract value of >I1 and 1: $-|>I1| - 1 = >I2$

>I1, negative value

Subtract value of >I1 and 1: $|>I1| - 1 = >I2$

5.6 C, counter relay

The counter relay (function relay) counts pulses that are received at counter input C_. The count direction can be set.

→ Counting is carried out cyclically. The time of a pulse must therefore be greater than twice the cycle time. The CH high-speed counter can be used for shorter pulses.

You can set a lower and higher limit setpoint as comparison values for the counter relay function block, as well as a start value.

MFD device allows the use of up to 32 counter relays.

→ Square wave count pulses are required to ensure a 1:1 mark to space ratio.
The relay counts only in RUN operating mode.

→ page 358 on Section "Example with timing relay and counter function block" provides information on the timing relay and counter function block.

5.6.1 Function block inputs/outputs

Counters C01...C32 (Counter)			
Boolean inputs/outputs		Parameters	
Contact	Coil	Input value	Output value
CY	Carry, value range overshoot ①		
FB	Fall below, actual value \leq lower setpoint ②		
OF	Overflow, actual value \geq upper setpoint ③		
ZE	Zero, 1 when actual value QV=0 ④		
	C_	Counter input ⑤	
	D_	Change count direction ⑥	
	RE	Set actual value (QV) to 0 ⑦	
	SE	Apply Start value (SV) ⑧	
		SH	Upper setpoint ⑨

Counters C01...C32 (Counter)			
Boolean inputs/outputs		Parameters	
Contact	Coil	Input value	Output value
		SL	Lower setpoint ⑩
		SV	Preset actual value ⑪
			QV Counter actual value ⑫

Read the description of the inputs/outputs in the legend points in the following tables.

5.6.2 Wiring of the function block

You wire the function block in the circuit diagram with its coils and its contacts.

5.6.2.1 Contacts

A closed contact indicates:

Parameters	Function
① C...OF	Reaching or exceeding the upper limit setpoint
② C...FB	Reaching or falling below the lower limit setpoint
③ C...ZE	Actual value at the function block output QV equals zero
④ C...CY	Exceeding of the value range for one cycle per rising counter edge. If it is closed, the function block retains the value of the last valid operation

5.6.2.2 Coils

Parameters	Function
⑤ C...C_	counter input, counts with every rising edge
⑥ C...RE	Reset of the counter relay to zero
⑦ C...D_	Count direction: 0: up counting, Status 1: down counting.
⑧ C...SE	SET: Transfer of the start value (SV) on a rising edge.

5 Function blocks
 5.6 C, counter relay

5.6.2.3 Example of a counter relay:

```
I 05-----[ C 20C_
I 06-----[ C 20RE
I 07-----[ C 20D_
I 08-----[ C 20SE
```

Figure 143: Wiring the function block coils

The function block coils are connected to the device inputs.

```
C 010F-----[ M 01
C 01FB-----[ M 02
C 01ZE-----[ M 03
C 01CY-----S M 42
```

Figure 144: Wiring the contacts

The messages of the function block are sent to markers.

5.6.3 Parametric programming of the function block inputs/outputs

5.6.3.1 Parameters

```
C 16      +
>SH
>SL
>SU
QU>
```

When using the function block in the circuit diagram for the first time, use OK to automatically enter the general display of function block parameters, as shown in the figure on the left. Enter the function block settings here. The display contains the following elements:

C 16	Function block: Counter relay, number 16
+	Parameter display: Call enabled
⑨ >SH	Upper setpoint, -2147483648 - 2147483647
⑩ >SL	Lower setpoint, -2147483648 - 2147483647
⑪ >SU	Start value (Defined actual value, Preset), -2147483648 - 2147483647
⑫ QU>	Current actual value, -2147483648 - 2147483647

The parameter set consists of:

Parameter Display

The display of the parameters during operation can be disabled. Additional information → section "4.9.2.1 Parameter assignment from the circuit diagram", page 191.

Parameters	Function
+	Parameters are displayed
-	Parameters are not displayed

This parameter is factory set to +.

Inputs

>SH und >SL: The upper and lower limit setpoints are set at function block inputs >SH and >SL respectively.

>SV: The start value is used to cause the function block to count from a specified offset value.

Parameters	Function
>SH	Upper setpoint: -2147483648 - 2147483647
>SL	Lower setpoint: -2147483648 - 2147483647
>SV	Start value: -2147483648 - 2147483647

You can assign the following operands to function block inputs >SH, >SL and >SV:

- Constant.
- Markers MD, MW, MB.
- Analog inputs IA01 to IA04:
 - IA01: Terminal I7.
 - IA02: Terminal I8.
 - IA03: Terminal I11.
 - IA04: Terminal I12.
- Analog output QA01.
- Output ...QV> of a different function block.

Output

Actual value output C..QV supplies the current actual value as an integer.

Parameters	Function
QV>	Actual value: -2147483648 - 2147483647

You can assign the following operands to output ...QV>:

- Analog output QA01.
- Markers MD, MW, MB.

Memory requirement

The counter relay function block requires 52 bytes of memory plus 4 bytes per constant at the function block inputs.

Cycle time

mode	Cycle time [µs]
-	46

5.6.3.2 Retention

Counter relays can be operated with retentive actual values. The number of retentive counter relays can be selected in the SYSTEM → RETENTION menu. The retentive actual value requires 4 bytes of memory.

If a counter relay is retentive, the actual value is retained when the operating mode changes from RUN to STOP as well as when the supply voltage is switched off. When is started in RUN mode, the counter relay continues with the retentively stored actual value. If MFD is started in RUN mode, the timing relay operates with the retentively saved actual value.

5.6.4 Function of the function block

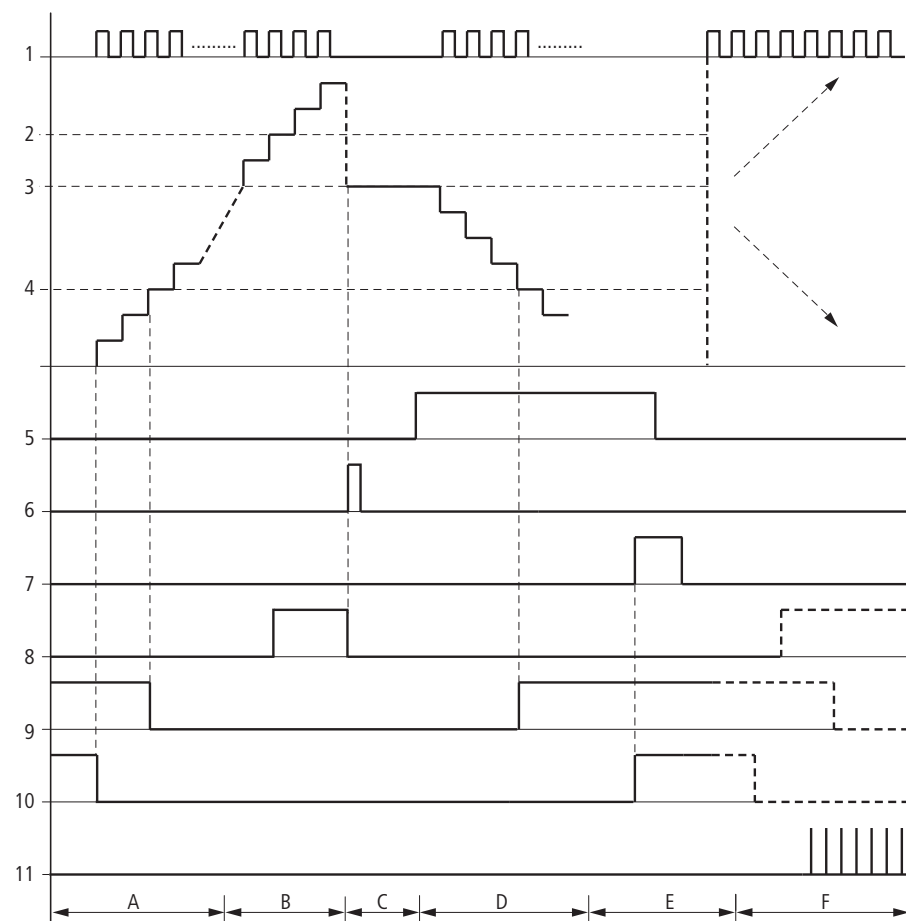

Figure 145: Signal diagram of counter relay

Legend for Figure145:

- 1: Counter coil C..C_
 - 2: Upper setpoint value >SH
 - 3: Start value >SV.
 - 4: Lower setpoint value >SL.
 - 5: Counting direction, coil C..D_
 - 6: Transfer start value, coil C..SE.
 - 7: Reset coil C..RE
 - 8: Contact (N/O) C..OF: Upper limit setpoint reached, exceeded
 - 9: Contact (N/O) C..FB lower limit setpoint reached, undershot
 - 10: Actual value equal to zero.
 - 11: Out of value range
- Range A:
 - The counter range has the value zero.
 - The contacts C..ZE (actual value equal to zero) and C..FB (lower setpoint value undershot) are active.
 - The counter receives pulses and increases the actual value.
 - C..ZE drops out as well as C..FB after the lower setpoint value is reached.
 - Range B:
 - The counter relay counts upwards and reaches the upper setpoint value. The “upper setpoint value reached” contact C..OF becomes active.
 - Range C:
 - The coil C..SE is briefly actuated and the actual value is set to the start value. The contacts go to the respective position.
 - Range D:
 - The counting direction coil C..D_ is actuated. If counting pulses are present, downward counting is initiated.
 - If the lower setpoint value is undershot, the contact C..FB becomes active.
 - Range E:
 - The reset coil C..RE is activated. The actual value is set to zero.
 - The contact C..ZE is active.
 - Range F:
 - The actual value goes outside the value range of the counter relay.
 - The contacts become active according to the direction of the values (positive or negative).

5.7 CF, frequency counter

All devices with DC inputs contain CF function blocks that enable frequency measurement independent of the cycle time.

You can set a lower and higher limit setpoint comparison values for the frequency counter function block.

4 frequency counters are provided.

5.7.1 Function block inputs/outputs

Frequency counter CF01...CF04 (Counter Frequency)									
Boolean inputs/outputs				Parameters					
Contact		Coil		Input value			Output value		
OF	Overflow, Actual value \geq Setpoint ①								
FB	Fall below, Actual value \leq Setpoint value ②								
ZE	Zero, Actual value equal to zero ③								
		EN	Enable for counter function block ④						
				SH	Upper setpoint ⑤				
				SL	Lower setpoint ⑥				
						QV	Current actual value ⑫		

Read the description of the inputs/outputs in the legend points in the following tables.



Square wave count pulses are required to ensure a 1:1 mark to space ratio.

5.7.1.1 Counter frequency

The frequency counter can be used between 3 kHz maximum and 4 Hz minimum.

5.7.1.2 Value range

The function block operates in the integer range from 4 to 3000 (1 kHz = 1000).

The value range cannot be exceeded as the maximum measured value is less than the value range.

5.7.2 Wiring of the function block



Note that the digital inputs I1 to I4 are permanently assigned to the frequency counter function blocks provided:

- I1: Counter input for counter CF01.
- I2: Counter input for counter CF02.
- I3: Counter input for counter CF03.
- I4: Counter input for counter CF04.

You wire the function block in the circuit diagram with its coils and its contacts.

5.7.2.1 Coil

Parameters	Function
④ CF..EN	Selective activation of the function block

5.7.2.2 Contacts

A closed contact indicates:

Parameters	Function
① CF..OF	Reaching or exceeding the upper limit setpoint
② CF..FB	Reaching or falling below the lower limit setpoint
③ CF..ZE	Actual value equals zero

5.7.2.3 Example of a frequency counter:

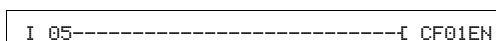

Figure 146: Wiring the function block coils

The counter input of the function block CF01 is already permanently connected to device input I1, the function of the function block is activated by the device input I5.

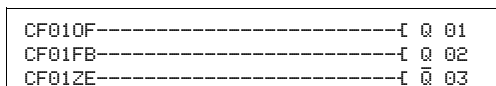

Figure 147: Wiring the function block contacts

The messages of the function block are sent directly to the device outputs.



Avoid unforeseeable switch states:

- Only use each function block coil once in the circuit diagram.
- If you use one of the inputs I1, I2, I3 or I4 as a counter input for the counter function block CF, CH or CI, they cannot be used for other purposes.

If an input I1...I4 is used several times, only the high-speed counter is run that is positioned last in the order of processing in the function block diagram.

5.7.3 Parametric programming of the function block inputs/outputs

5.7.3.1 Parameters

```
CF01    -
  >SH
  >SL
  QU>
```

When using the function block in the circuit diagram for the first time, use OK to automatically enter the general display of function block parameters, as shown in the figure on the left. Enter the function block settings here. The display contains the following elements:

CF01	Function block: Frequency counter, number 01
-	Parameter display: Call not enabled
⑤ >SH	Upper setpoint: 0 - 3000 Hz
⑥ >SL	Lower setpoint: 0 - 3000 Hz
⑦ QU>	Current frequency value in RUN mode: 0...3000 Hz

The parameter set consists of:

Parameter Display

The display of the parameters during operation can be disabled. Additional information → section "4.9.2.1 Parameter assignment from the circuit diagram", page 191.

Parameters	Function
+	Parameters are displayed
-	Parameters are not displayed

This parameter is factory set to +.

Inputs

>SH und >SL: The upper and lower limit setpoints are set at >SH and >SL respectively. The function block inputs >SH and >SL can have the following operands:

- Constant.
- Markers MD, MW, MB.
- Analog inputs IA01 to IA04:
 - IA01: Terminal I7.
 - IA02: Terminal I8.
 - IA03: Terminal I11.
 - IA04: Terminal I12.
- Analog output QA01.
- Output ...QV> of a different function block.

5.7.3.2 Output

QV>: The output CF..QV outputs the actual frequency at the counter input as an integer. You can assign the following operands to output ...QV>:

- Analog output QA01.
- Markers MD, MW, MB

Memory requirement

The frequency counter function block requires 40 bytes of memory plus 4 bytes per constant at the function block inputs.

Cycle time

mode	Cycle time [µs]
-	30

5.7.3.3 Retention

The frequency counter does not have any retentive actual values since the frequency is continuously remeasured.

5.7.4 Function of the function block



The following requirements must be fulfilled for frequency display:

- The function block operation is activated by the coil QF..EN.
- The device is in RUN mode.

The pulses on the input are counted for one second irrespective of the cycle time, and the frequency is determined. The measurement result is provided at the function block output CF..QV.

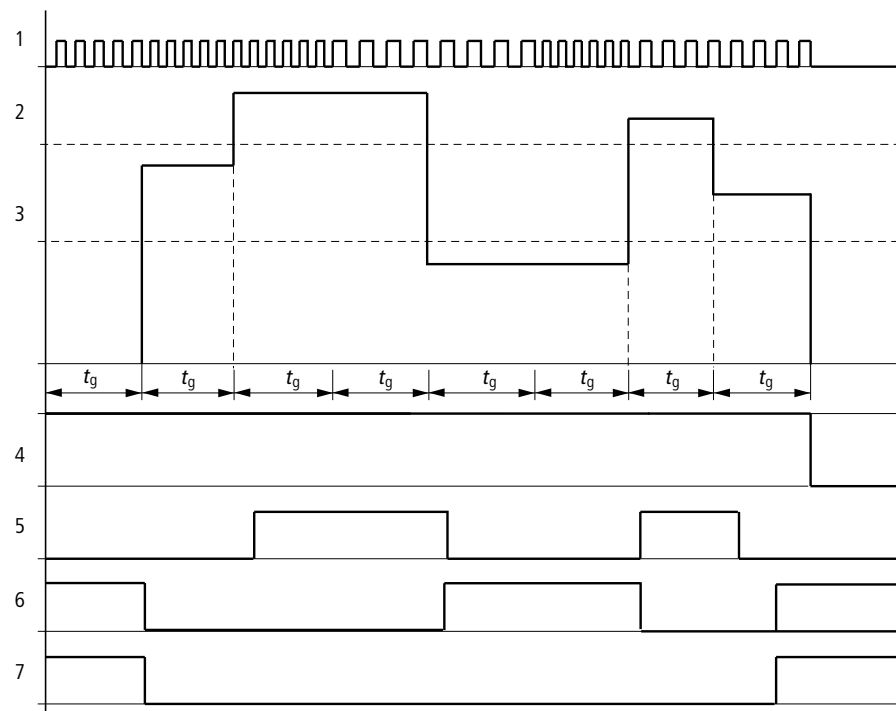

Figure 148: Signal diagram of frequency counter

1: Counter input I1 to I4.

2: Upper setpoint value >SH

3: Lower setpoint value >SL.

4: Enable CF..EN

5: Contact (N/O) CF..OF: Upper setpoint value exceeded

6: Contact (N/O) CF..FB: Lower setpoint value undershot.

7: Actual value equal to zero CF..ZE

8. t_g : Gate time for the frequency measurement.

- The first measurements are made after the CF..EN enable signal has been activated. The value is output after the gate time has timed out.
- The contacts are set in accordance with the measured frequency.
- If the CF..EN enable signal is removed, the output value is set to zero.

5.8 CH, high-speed counter

All devices with DC inputs contain CH function blocks that enable up and down counting on a rising edge, independent of the cycle time.

You can set a lower and higher limit as comparison values for the high-speed counter function block, as well as a start value.

Four high-speed function blocks are provided.



Square wave count pulses are required to ensure a 1:1 mark to space ratio.

5.8.0.1 Counter frequency

The counter frequency is a maximum of 3000 Hz and a minimum 4 Hz.

5.8.1 Function block inputs/outputs

High-speed counter CH01...CH04 (Counter Highspeed)							
Boolean inputs/outputs				Parameters			
Contact		Coil		Input value		Output value	
OF	Overflow, Actual value \geq Setpoint value ①						
FB	Fall below, Actual value \leq Setpoint value ②						
ZE	Zero, Actual value = 0 ③						
CY	Exceeding of the value range ④						
		C_	Counter input ⑤				
		RE	Reset ⑥				
		D_	Change count direction ⑦				
		SE	Apply Start value (SV) ⑧				
				SH	Upper setpoint ⑨		
				SL	Lower setpoint ⑩		
				SV	Start value ⑪		
						QV	Current actual value ⑫

Read the description of the inputs/outputs in the legend points in the following tables.

5.8.2 Wiring of the function block



Note that the digital inputs I1 to I4 are permanently assigned to the frequency counter function blocks provided:

- I1: Counter input for counter CH01.
- I2: Counter input for counter CH02.
- I3: Counter input for counter CH03.
- I4: Counter input for counter CH04.

You wire the function block in the circuit diagram with its coils and its contacts.

5.8.2.1 Coils

	Parameters	Function
①	CH..EN	Selective activation of the function block
②	CH..RE	Reset the actual value to zero
③	CH..D_	Count direction Picked up: up counting, Not picked up: down counting.
④	CH..SE	Transfer of the start value on a rising edge.

5.8.2.2 Contacts

A closed contact indicates:

	Parameters	Function
⑧	CH..OF	Reaching or exceeding the upper limit setpoint
⑨	CH..FB	Reaching or falling below the lower limit setpoint
⑩	CH..ZE	Actual value equals zero
⑪	CH..CY	Value range exceeded, If it is closed, the function block retains the value of the last valid operation.

5.8.2.3 High-speed counter example:

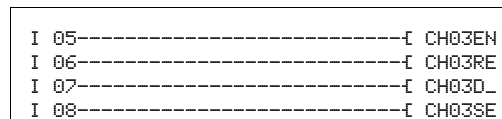

Figure 149: Wiring the function block coils

The counter input of the function block CH03 is already permanently connected to device input I3. The coils of the function block are connected directly to the device inputs. The coils of the function block are connected here directly to the device inputs.

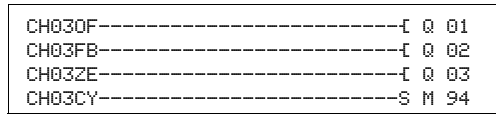

Figure 150: Wiring the function block contacts

The contacts of the function block are connected to the device outputs and a marker.



Avoid unforeseeable switch states:

- Only use each function block coil once in the circuit diagram.
- If you use one of the inputs I1, I2, I3 or I4 as a counter input for the counter function block CF, CH or CI, they cannot be used for other purposes.

If an input I1...I4 is used several times, only the high-speed counter is run that is positioned last in the order of processing in the function block diagram

5.8.3 Parametric programming of the function block inputs/outputs

5.8.3.1 Parameters

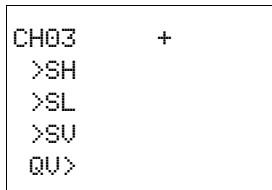

When using the function block in the circuit diagram for the first time, use OK to automatically enter the general display of function block parameters, as shown in the figure on the left. Enter the function block settings here.

The display contains the following elements:

CH03	Function block: High-speed counter, number 03
+	Parameter display: Call enabled
⑤ >SH	Upper setpoint: -2147483648 - 2147483647
⑥ >SL	Lower setpoint: -2147483648 - 2147483647
⑦ >SU	Start value (Preset): -2147483648 - 2147483647
⑫ QU>	Actual value: -2147483648 - 2147483647

The parameter set consists of:

Parameter Display

The display of the parameters during operation can be disabled. Additional information → section "4.9.2.1 Parameter assignment from the circuit diagram", page 191.

Parameters	Function
+	Parameters are displayed
-	Parameters are not displayed

This parameter is factory set to +.

5 Function blocks

5.8 CH, high-speed counter

Inputs

>SH und >SL: The upper and lower limit setpoints are set at >SH and >SL respectively.

>SV: The start value is used to cause the function block to count from a specified value (Offset).

You can assign the following operands to function block inputs >SH, >SL and >SV:

- Constant.
- Markers MD, MW, MB.
- Analog inputs IA01 to IA04:
 - IA01: Terminal I7.
 - IA02: Terminal I8.
 - IA03: Terminal I11.
 - IA04: Terminal I12.
- Analog output QA01.
- Output ...QV> of a different function block.

Output

QV>: Actual value output CH..QV outputs the current actual value as an integer. You can assign the following operands to output ...QV>:

- Analog output QA01.
- Markers MD, MW, MB.



The actual value can only be cleared in RUN mode with a specific reset signal.

Memory requirement

The high-speed counter function block requires 52 bytes of memory plus 4 bytes per constant at the function block inputs.

Cycle time

mode	Cycle time [µs]
-	52

5.8.3.2 Retention

High-speed counter relays can be operated with retentive actual values. The number of retentive counter relays can be selected in the SYSTEM -> RETENTION menu.

If a meter is retentive, the actual value is retained when the operating mode changes from RUN to STOP as well as when the supply voltage is switched off.

If a MFD is started in RUN mode, the counter operates with the retentively saved actual value.

5.8.4 Function of the function block

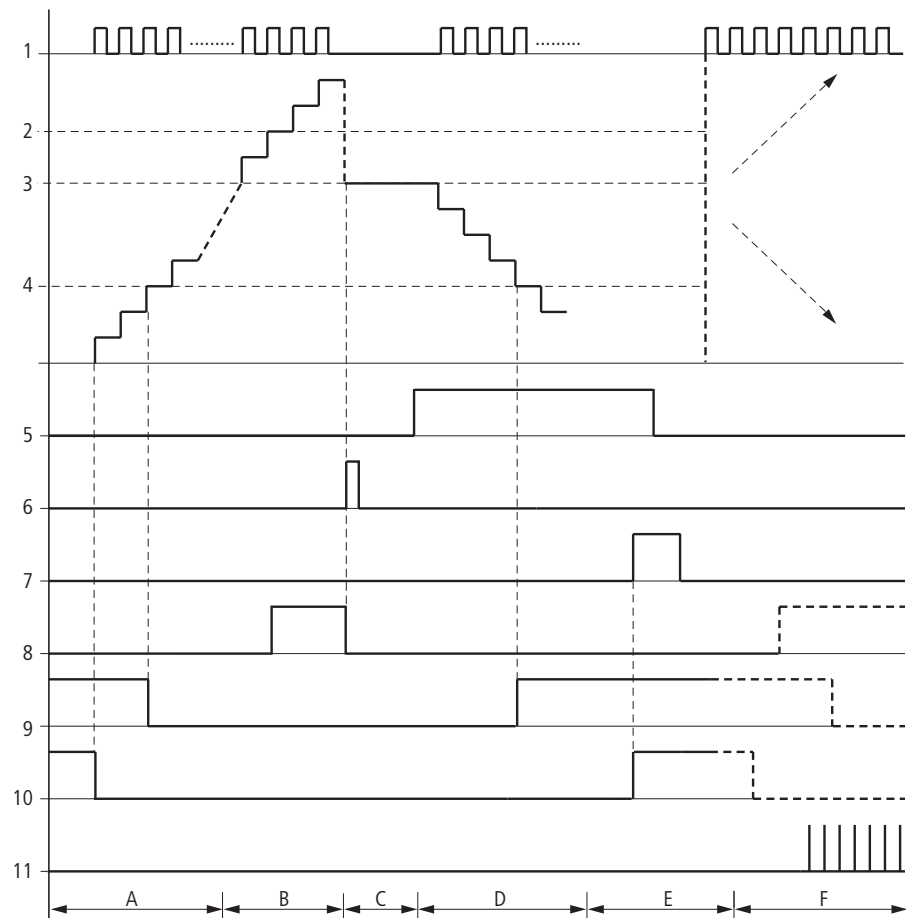

Figure 151: Signal diagram of high-speed counter

- 1: Counter input I1 to I4.
- 2: Upper setpoint value >SH
- 3: Start value >SV.
- 4: Lower setpoint value >SL.
- 5: Enable of the counter CH...EN
- 6: Count direction, coil CH...D
- 7: Transfer start value, coil CH..SE.
- 8: Reset coil CH...RE
- 9: Contact (N/O) CH...OF: Upper setpoint value reached or exceeded.
- 10: Contact (N/O) CH...FB: Lower setpoint value reached or undershot.
- 11: Contact (N/O) CH...ZE: Actual value equal to zero
- 12: Out of value range.
- Range A:
 - The counter has the value zero.
 - The contacts CH..ZE (actual value = zero) and CH..FB (lower setpoint value undershot) are active.
 - The counter receives pulses and increases the actual value.
 - CH..ZE as well as CH..FB drop out when the lower setpoint value is reached.
- Range B:
 - The counter counts upwards and reaches the upper setpoint value. The contact “upper setpoint value” CH...OF becomes active.
- Range C:
 - The coil CH..SE is briefly actuated and the actual value is set to the start value. The contacts go to the respective position.

5 Function blocks

5.8 CH, high-speed counter

- Range D:
 - The counting direction coil CH...D is actuated. If counting pulses are present, downward count is initiated.
 - If the lower setpoint value is undershot, the contact CH..FB becomes active.
- Range E:
 - The reset coil CH...RE is activated. The actual value is set to zero.
 - The contact CH...ZE is active.
- Range F:
 - The actual value goes outside the value range of the counter.
 - The contacts become active according to the direction of the values (positive or negative).

5.9 CI, High-speed incremental value counter

All devices with DC inputs enable high-speed up and down counting on a rising or falling edge that is independent of the cycle time.

You can set a lower and higher setpoint value as comparison values for the incremental counter function block, as well as a start value.

There are 2 incremental counter available.



Square wave count pulses are required to ensure a 1:1 mark to space ratio.

The signals of channels A and B must be offset by 90° otherwise the count direction will not be detected.

5.9.0.1 Counter frequency

The maximum count frequency is 3000 Hz.

5.9.1 Function block inputs/outputs

Incremental counter CI01...CI02 (Counter Incremental)							
Boolean inputs/outputs				Parameters			
Contact		Coil		Input value		Output value	
OF	Overflow, Actual value \geq Setpoint value ①						
FB	Fall below, Actual value \leq Setpoint ②						
ZE	Zero, Actual value = 0 ③						
CY	Value range exceeded ④						
		EN	Enable ⑤				
		RE	Reset ⑥				
		SE	Apply Start value (SV) ⑦				
				SH	Upper setpoint		
				SL	Lower setpoint ⑨		
				SV	Start value ⑩		
						QV	Current actual value ⑪

Read the description of the inputs/outputs in the legend points in the following tables.

5 Function blocks

5.9 CI, High-speed incremental value counter

5.9.2 Wiring of the function block



Note that the digital inputs I1 to I4 are permanently assigned to the incremental counter function blocks provided:

- I1: Counter input for counter CI01, channel A.
- I2: Counter input for counter CI01, channel B.
- I3: Counter input for counter CI02, channel A.
- I4: Counter input for counter CI02, channel B.

You wire the function block in the circuit diagram with its coils and its contacts.

5.9.2.1 Coils

The coils of the function block is used in the circuit diagram.

Parameters	Function
⑤ CI..EN	Selective activation of the function block
⑥ CI..RE	Reset the actual value to zero
⑦ CI..SE	Transfer of the start value on a rising edge.

5.9.2.2 Contacts

The contacts of the function block are evaluated in the circuit diagram. A closed contact indicates:

Parameters	Function
① CI..OF	Reaching or exceeding the upper limit setpoint
② CI..FB	Reaching or falling below the lower limit setpoint
③ CI..ZE	Actual value equals zero
④ CI..CY	Value range exceeded, If it is closed, the function block retains the value of the last valid operation.

5.9.2.3 Example of a high-speed incremental counter:

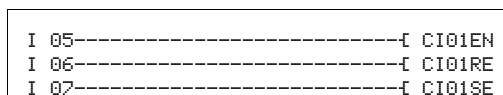

Figure 152: Wiring the function block coils

The count inputs of function block CI01 are already permanently assigned to device inputs I1 and I2. The coils of the function block are connected directly here to the device inputs.

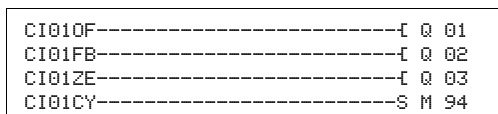

Figure 153: Wiring the function block contacts

The contacts of the function block are connected to the device outputs and a marker.



Avoid unforeseeable switch states:

- Only use each function block coil once in the circuit diagram.
- If you use one of the inputs I1, I2, I3 or I4 as a counter input for the counter function block CF, CH or CI, they cannot be used for other purposes.
If an input I1...I4 is used several times, only the high-speed counter is run that is positioned last in the order of processing in the function block diagram

5.9.3 Parametric programming of the function block inputs/outputs

5.9.3.1 Parameters

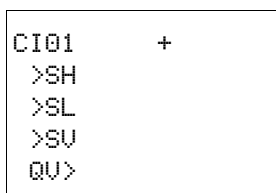

When using the function block in the circuit diagram for the first time, use OK to automatically enter the general display of function block parameters, as shown in the figure on the left. Enter the function block settings here. The display contains the following elements:

CI01	Function block: High-speed Incremental value counter, number 01
+	Parameter display: Call enabled
⑧ >SH	Upper setpoint: -2147483648 - 2147483647
⑨ >SL	Lower setpoint: -2147483648 - 2147483647
⑩ >SV	Start value (Preset): -2147483648 - 2147483647
⑪ QU>	Current actual value: -2147483648 - 2147483647

The parameter set consists of:

Parameter Display

The display of the parameters during operation can be disabled. Additional information → section “4.9.2.1 Parameter assignment from the circuit diagram”, page 191.

Parameters	Function
+	Parameters are displayed
-	Parameters are not displayed

This parameter is factory set to +.

5 Function blocks

5.9 CI, High-speed incremental value counter

Inputs

>SH und >SL: The upper and lower limit setpoints are set at function block inputs >SH and >SL respectively.

>SV: The start value is used to cause the function block to count from a specified offset value.

You can assign the following operands to function block inputs >SH, >SL and >SV:

- Constant.
- Markers MD, MW, MB.
- Analog inputs IA01 to IA04:
 - IA01: Terminal I7.
 - IA02: Terminal I8.
 - IA03: Terminal I11.
 - IA04: Terminal I12.
- Analog output QA01.
- Output ...QV> of a different function block.

Output

QV>: Actual value output CI..QV outputs the current actual value as an integer. You can assign the following operands to output ...QV>:

- Analog output QA01.
- Markers MD, MW, MB.



The actual value can only be cleared in RUN mode with a Reset signal.

Memory requirement

The function block requires 52 bytes of memory plus 4 bytes per constant at the function block inputs.

Cycle time

mode	Cycle time [µs]
-	47

5.9.3.2 Retention

The counter can be operated with retentive actual values. The number of retentive counters is selected in SYSTEM → RETENTION.

If a meter is retentive, the actual value is retained when the operating mode changes from RUN to STOP as well as when the supply voltage is switched off.

If a MFD is started in RUN mode, the counter operates with the retentively saved actual value.

5.9.4 Function of the function block



The incremental counter evaluates the rising and falling edges and counts twice the number of pulses. This prevents too many or too few pulses from being counted if there is oscillation on a signal edge. If the number of pulses are required, divide the value by two.

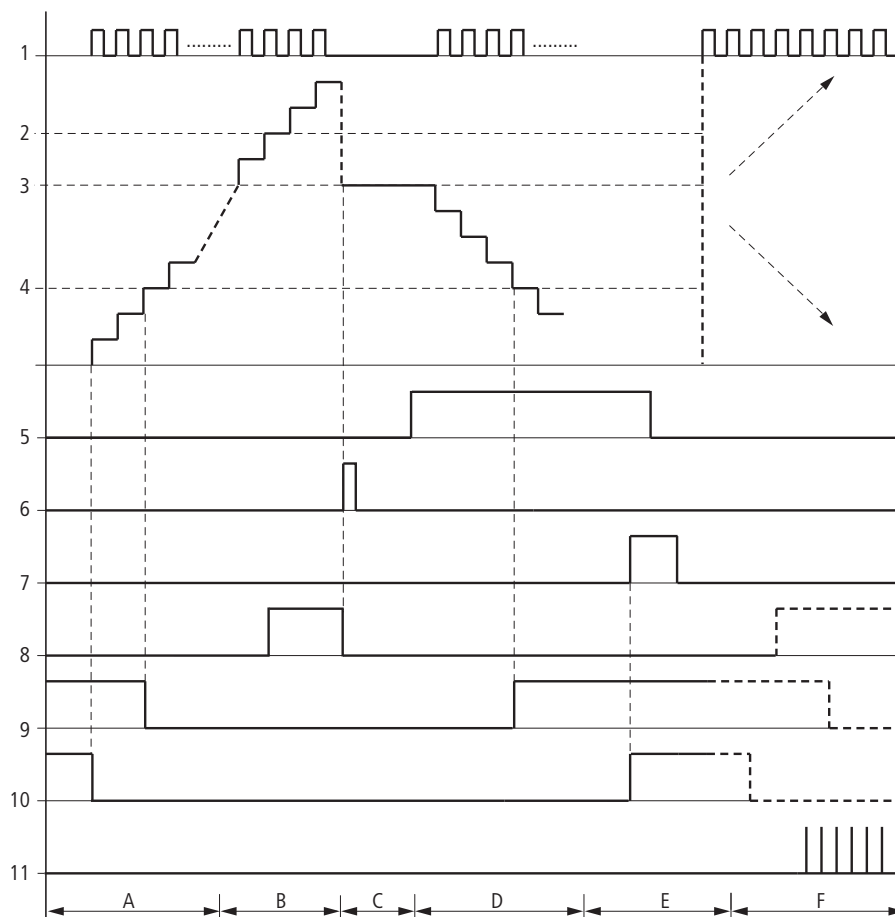

Figure 154: Signal diagram of high-speed counter

- 1: Counter input I1 to I4.
- 2: Upper setpoint value >SH
- 3: Start value >SV.
- 4: Lower setpoint value >SL.
- 5: Enable of the counter CI...EN
- 6: Counting direction, coil CI...D
- 7: Transfer start value, coil CI...SE.
- 8: Reset coil CI...RE
- 9: Contact (N/O) CI...OF: Upper setpoint value reached or exceeded.
- 10: Contact (N/O) CI...FB: Lower setpoint value reached or undershot.
- 11: Contact (N/O) CI...ZE: Actual value equal to zero

5 Function blocks

5.9 CI, High-speed incremental value counter

12:Out of value range.

- Range A:
 - The counter has the value zero.
 - The contacts CI..ZE (actual value = zero) and CI..FB (lower setpoint value undershot) are active.
 - The counter receives pulses and increases the actual value.
 - CI..ZE drops out as well as CI..FB and also when the lower setpoint value is reached.
- Range B:
 - The counter counts upwards and reaches the upper setpoint value. The “upper setpoint value reached” contact CI..OF becomes active.
- Range C:
 - The coil CI..SE is briefly actuated and the actual value is set to the start value. The contacts go to the respective position.
- Range D:
 - The counting direction coil CI...D is actuated. If counting pulses are present, downward counting is initiated.
 - If the lower setpoint value is undershot, the contact CI..FB becomes active.
- Range E:
 - The reset coil CI..RE is activated. The actual value is set to zero.
 - The contact CI..ZE is active.
- Range F:
 - The actual value goes outside the value range of the counter.
 - The contacts become active according to the direction of the values (positive or negative).

5.10 CP, comparator

This function block is used to compare variables and/or constants with each other. The following scans are possible:

- >I1 greater than >I2
- >I1 equal to >I2
- >I1 less than >I2

MFD device allows the use of up to 32 comparators.

5.10.1 Function block inputs/outputs

Comparators CP1...CP32 (Compare)			
Boolean inputs/outputs		Parameters	
Contact	Coil	Input value	Output value
LT	Value at I1 < I2 ①		
EQ	Value at I1 = I2 ②		
GT	Value at I1 > I2 ③		
		I1	Value 1 ④
		I2	Value 2 ④

Read the description of the inputs/outputs in the legend points in the following tables.

5.10.2 Wiring of the function block

You wire the function block in the circuit diagram with its contacts.

5.10.2.1 Contacts

A closed contact indicates:

Parameters	Function, parameterization in the function block
① CP..LT	>I1 less than >I2
② CP..EQ	>I1 equal to >I2
③ CP..GT	>I1 greater than >I2

5.10.2.2 Example:

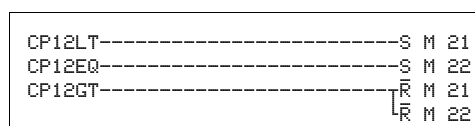
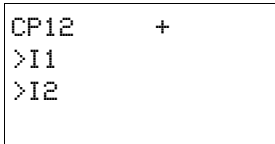

Figure 155: Wiring the function block contacts

The contact of the function block is sent to markers.

5.10.3 Parametric programming of the function block inputs/outputs

5.10.3.1 Parameters



When using the function block in the circuit diagram for the first time, use OK to automatically enter the general display of function block parameters, as shown in the figure on the left. Enter the function block settings here. The display contains the following elements:

CP12	Function block: Data block comparator, number 12
+	Parameter display: Call enabled
④ >I1	First value to be compared with the value at I2: -2147483648 - 2147483647
>I2	Second value: -2147483648 - 2147483647

The parameter set consists of:

Parameter Display

The display of the parameters during operation can be disabled. Additional information → section "4.9.2.1 Parameter assignment from the circuit diagram", page 191.

Parameters	Function
+	Parameters are displayed
-	Parameters are not displayed

This parameter is factory set to +.

Inputs

>I1 and >I2: The signals present at inputs >I1 and >I2 are compared with each other. You can assign the following operands to function block inputs:

- Constant.
- Markers MD, MW, MB.
- Analog inputs IA01 to IA04:
 - IA01: Terminal I7.
 - IA02: Terminal I8.
 - IA03: Terminal I11.
 - IA04: Terminal I12.
- Analog output QA01.
- Output ...QV> of a different function block.

Memory requirement

The function block requires 32 bytes of memory plus 4 bytes per constant at the function block inputs.

Cycle time

mode	Cycle time [μ s]
-	24

5.10.4 Function of the function block

The function block compares values present at the inputs >I1 and >I2.

The following contacts close depending on the comparison result:

- >I1 greater than >I2, GT contact closes.
- >I1 equal to >I2, EQ contact closes.
- >I1 less than >I2, LT contact closes.

5.11 DB, data block

The function block stores values such as setpoints for function blocks. The value present at input I1 is stored in the operand associated with the output QV.

MFD device allows the use of up to 32 data function blocks.

5.11.1 Function block inputs/outputs

Data function block DB1...DB32 (Data Block)							
Boolean inputs/outputs				Parameters			
Contact		Coil		Input value		Output value	
Q1	Trigger confirmation ①						
		T_	Trigger Signal ②				
				I1	Value to transfer ③		
						QV	Transferred actual value ④

Read the description of the inputs/outputs in the legend points in the following tables.

5.11.2 Wiring of the function block

You wire the function block in the circuit diagram with its trigger coil and its contact.

5.11.2.1 Coil

The coil is used in the standard circuit diagram to transfer the value at input >I1 to the function block and supply it on its output.

Parameters	Function
② DB..T_	Transfer the value to >I1 with a rising edge.

5.11.2.2 Contact

A closed contact indicates that the transferred value is output on the output.

Parameters	Function
① DB..Q1	Transfer confirmation with 1, if T_ is 1.

5.11.2.3 Example of a data function block:

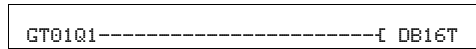

Figure 156: Wiring the trigger coil

The trigger coil is addressed via the network.

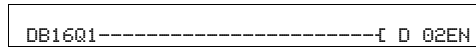
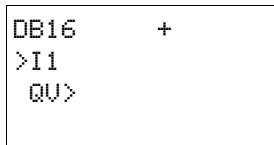

Figure 157: Wiring of the function block contact

The output of the data function block DB16Q1 is assigned to the input D02 EN of the text display function block.

5.11.3 Parametric programming of the function block inputs/outputs

5.11.3.1 Parameters



When using the function block in the circuit diagram for the first time, use OK to automatically enter the general display of function block parameters, as shown in the figure on the left. Enter the function block settings here.

The display contains the following elements:

DB16	Function block: Data function block, number 16
+	Parameter display: Call enabled
③ >I1	Input value: -2147483648 - 2147483647
④ QV>	Outputs the value of DB..I1 when triggered: -2147483648 - +2147483647

The parameter set consists of:

Parameter Display

The display of the parameters during operation can be disabled. Additional information → section “4.9.2.1 Parameter assignment from the circuit diagram”, page 191.

Parameters	Function
+	Parameters are displayed
-	Parameters are not displayed

This parameter is factory set to +.

Input

>I1: You apply the value that is transferred on triggering to the function block input >I1. The function block input >I1 can be assigned the following operands:

- Constant.
- Markers MD, MW, MB.

5 Function blocks

5.11 DB, data block

- Analog inputs IA01 to IA04:
 - IA01: Terminal I7.
 - IA02: Terminal I8.
 - IA03: Terminal I11.
 - IA04: Terminal I12.
- Analog output QA01.
- Output ...QV> of a different function block.

Output

QV>: The output provides the input value when triggered as an integer. You can assign the following operands to output ...QV>:

- Analog output QA01.

Markers MD, MW, MB. Memory requirement

The data block function block requires 36 bytes of memory plus 4 bytes per constant at the function block input.

Cycle time

mode	Cycle time [μ s]
-	28

5.11.3.2 Retention

Data function blocks can be operated with retentive actual values. The quantity can be selected in the SYSTEM → RETENTION menu.

5.11.4 Function of the function block

The value at input >I1 is only transferred with a rising trigger edge to an operand (e.g.: MD42) at output QV>. It contains the value up to the next time it is overwritten.

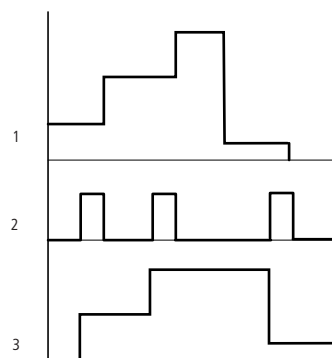

Figure 158: Signal diagram of data function block

- 1: Value at input DB..>I1
- 2: Trigger coil DB...T_
- 3: Value on DB...QV>

5.12 DC, PID controller

32 PID controllers are provided.



DANGER

A knowledge of closed-loop control is required in order to use the PID controllers.

The control system must be familiar to the user so that the PID controller can function correctly.



Three manipulated variables can be output independently of each other:

- One manipulated variable can be output via an analog output.
- Two other manipulated variables can be processed via two pulse-width modulated outputs.

However, it is in most cases useful to run no more than three closed-loop controllers per program simultaneously. If your application requires more than three closed-loop controllers, distribute them over several programs. You can structure your projects by selecting the controller number.

Example: Project with 3 devices:

- Program 1: Controller DC 10, 11
- Program 2: Controller DC20, 21 and 22
- Program 3: Controller DC30.



If you are using the function block in time consuming applications such as in conjunction with an FT signal smoothing filter, you should not program any other time consuming applications on this device, such as visualizations on the MFD. The refreshing of screen(s) can increase the cycle time and thus restrict the controller function. Distribute the applications among two or more devices that you can interconnect via easyNet.

5.12.1 Function block inputs/outputs

PID-controller DC01...DC32 (Digital Control)							
Boolean inputs/outputs				Parameters			
Contact		Coil		Input value		Output value	
EN	Activation of the function block ①						
EP	Activation of the P component ②						
EI	Activation of the I component ③						
ED	Activation of the D component ④						
SE							
		LI	Status "1", = Value range of manipulated value exceeded ⑤				
				I1	Setpoint value ⑥		
				I2	Setpoint value ⑦		
				KP	Proportional gain ⑧		
				TN	Reset time ⑨		
				TV	Rate time ⑩		
				TC	Scan time ⑪		
				MV	Manual manipulated variable ⑫		
						QV	Manipulated variable ⑬

Read the description of the inputs/outputs in the legend points in the following tables.

5.12.2 Wiring of the function block

You wire the function block in the circuit diagram with its coils and its contacts.

5.12.2.1 Coils

You use the coils of the function block to activate it, the individual elements of the PID controller and manual mode.

Parameters	Function
① DC...EN	Selective activation of the function block
② DC...EP	Activation the proportional function
③ DC...EI	Activating the integral function
④ DC...ED	Activating the differential function
⑤ DC...SE	Activating the manual manipulated variable, manual mode

5.12.2.2 Contact

A closed contact indicates that the value range of the manipulated variable has been exceeded.

Parameters	Function
⑤ DC..LI	Closes when exceeding the manipulated value range.

5.12.2.3 Example of a PID controller:

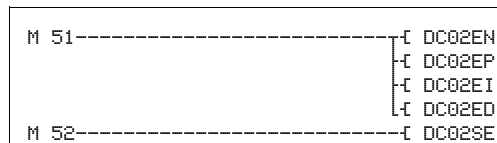

Figure 159: Wiring the function block coils

The function block coils are activated by markers.

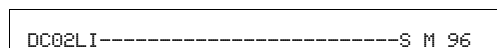

Figure 160: Wiring the contacts

The message of the function block is sent to a marker.

5.12.3 Parametric programming of the function block inputs/outputs

5.12.3.1 Parameters

```
DC02 UNP +
>I1
>I2
>KP
>TN
>TV
>TC
>MV
QU>
```

When using the function block in the circuit diagram for the first time, use OK to automatically enter the general display of function block parameters, as shown in the figure on the left. Enter the function block settings here. The display contains the following elements:

DC02	Function block: PID controller, number 02
UNP	Operating mode: Unipolar
+	Parameter display: Call enabled
⑥ >I1	Setpoint of PID controller: -32768 - +32767
⑦ >I2	Actual value of PID controller: -32768 - +32767
⑧ >KP	Proportional Gain K_p : 0 - 65535, in %; Example: The value 1500 is processed in the function block as 15.
⑨ >TN	Reset Time T_n : 0 - 65535, in 100 ms; Example: The value 250 is processed in the function block as 25 s.
⑩ >TV	Derivate Action Time T_v : 0 - 65535, in 100 ms; Example: The value 20 is processed in the function block as 2 s.

5 Function blocks

5.12 DC, PID controller

⑪	>TC	Scan Time T_c : 0 - 65535, in 100 ms
⑫	>MV	Manual manipulated variable: -4096 - +4095
⑭	QU>	Manipulated variable: <ul style="list-style-type: none"> • Unipolar: 0 - 4095 • Bipolar: -4096 - +4095

The parameter set consists of:

Operating Mode

The operating mode defines the value range of the manipulated variable.

Parameters	Function
UNP	Unipolar 12-bit value: 0 to +4095
BIP	Bipolar 13-bit value: (signed 12-bit value) -4096 - +4095

Parameter Display

The display of the parameters during operation can be disabled. Additional information → section "4.9.2.1 Parameter assignment from the circuit diagram", page 191.

Parameters	Function
+	Parameters are displayed
-	Parameters are not displayed

This parameter is factory set to +.

Inputs

>I1 and >I2: The PID controller setpoint and actual values are set at function block inputs >I1 and >I2.

>KP: Input >KP is used to adjust the control difference to the required proportional gain.

>TN: The value for the reset time T_n at input >TN is used for forming the integral component.

>TV: The value for the rate time T_v at input >TV is used for forming the differential component.

>TC: The value for the scan time T_c at input >TC determines the time intervals in which the operating system calls the function block for processing. If the value 0 is set, the cycle time of the device is the pause time between the function block calls.



The device cycle time varies according to the length of the program. With a scan time of 0 s, this may cause an irregular control response.



Use the Set cycle time function block (→ section “5.28 ST, Set cycle time”, page 337) in order to keep the cycle time of the device constant.

>MV: The set value of the manual manipulated variable M_v is output on the output DC..QV as a manipulated variable during activation of coil DC..SE.

You can assign the following operands to function block inputs >I1, >I2, >KP, >TN, >TV, >TC and >MV:

- Constant.
- Markers MD, MW, MB.
- Analog inputs IA01 to IA04:
 - IA01: Terminal I7.
 - IA02: Terminal I8.
 - IA03: Terminal I11.
 - IA04: Terminal I12.
- Analog output QA01.
- Output ...QV> of a different function block.

Output

The output DC..QV supplies the current manipulated variable as an integer.

You can assign the following operands to output ...QV>:

- Analog output QA01.
- Markers MD, MW, MB.

Memory requirement

The counter relay function block requires 96 bytes of memory plus 4 bytes per constant at the function block inputs.

Cycle time

The execution time depends on the mode.

mode	Cycle time [μ s]
P	27
I	27
PI	27
PD	27
PID	

5.12.4 Function of the function block

The controller operates on the basis of the equation of the PID algorithm. According to this, the manipulated variable $Y(t)$ is the result of the calculation of the proportional component, an integral component and a differential component.



The PID controller must be enabled so that it can work, i.e. the coil DC..EN must be active. If coil DC...EN is not active, the entire PID controller is deactivated and reset. The manipulated variable is set to zero.

The coils for calculating the P, I and/or D components must be active.

Example: If only coils DC...EP and DC...EI are activated, the controller operates as a PI controller.



The device calculates the manipulated variable every time the scan time T_c has elapsed. If the scan time is zero, the manipulated variable is calculated every cycle.

PID controller equation:

$$Y(t) = Y_P(t) + Y_I(t) + Y_D(t)$$

$Y(t)$ = Calculated manipulated variable with scan time t .

$Y_P(t)$ = Value of the proportional component of the manipulated variable with scan time t .

$Y_I(t)$ = Value of the integral component of the manipulated variable with scan time t .

$Y_D(t)$ = Value of the differential component of the manipulated variable with scan time t .

Proportional component

The proportional component Y_P is the product of the gain (K_p) and the control difference (e). The control difference is the difference between the setpoint (X_s) and the actual value (X_i) at a specified scan time. The equation used by the device for the proportional component is as follows:

$$Y_P(t) = K_p \times [X_s(t) - X_i(t)]$$

K_p = Proportional gain.

$X_s(t)$ = Setpoint with scan time t .

$X_i(t)$ = Actual value with scan time t

Integral component

The integral component Y_I is proportional to the sum of the control difference over time. The equation used by the device for the integral component is as follows:

$$Y_I(t) = K_p \times T_c/T_n \times [X_s(t) - X_i(t)] + Y_I(t-1)$$

K_p = Proportional gain.

T_c = Scan time.

T_n = Reset time (also known as integration time).

$X_s(t)$ = Setpoint with scan time t .

$X_i(t)$ = Actual value with scan time t .

$Y_I(t-1)$ = Value of the integral component with scan time $t - 1$.

Differential component

The differential component Y_D is proportional to the change in the control difference. So as to avoid step changes or jumps in the manipulated variable caused by the differential behaviour when the setpoint is changed, the change of the actual value (the process variable) is calculated and not the change in the control difference. This is shown in the following equation:

$$Y_D(t) = K_p \times T_v/T_c \times (X_i(t-1) - X_i(t))$$

K_p = Proportional gain

T_c = Scan time.

T_v = Rate time of the control system (also called the differential time)

$X_i(t)$ = Actual value with scan time t .

$X_i(t-1)$ = Actual value with scan time $t - 1$.

5.12.4.1 Manual mode of the PID controller

A value must be present at the >MV input in order to set the manipulated variable directly. If the coil DC...SE is activated, the value at >MV is transferred directly as manipulated variable QV>. This value is present for as long as the DC...SE coil is activated or the value at the >MV input is changed. If the coil DC..SE is no longer triggered, the control algorithm is active again.



Extreme changes in the manipulated variable can occur when the manual manipulated variable is transferred or deactivated.



If the function block is running in UNI (unipolar) mode, a negative signed manipulated variable value will be output as the value zero.

5 Function blocks

5.13 FT, signal smoothing filter

5.13 FT, signal smoothing filter

The function block smoothes noisy signals such as analog input signals. It operates as a low pass filter. 32 signal smoothing filter function blocks are provided.

5.13.1 Function block inputs/outputs

Signal smoothing filter FT1...FT32 (FilTer)								
Boolean inputs/outputs				Parameters				
Contact		Coil		Input value			Output value	
		EN	Activation/reset of the function block ①					
				I1	Input value ②			
				TG	Recovery time ③			
				KP	Proportional gain (in %) ④			
						QV	Output value ⑤	

Read the description of the inputs/outputs in the legend points in the following tables.



If you are using the function block in time consuming applications such as in conjunction with a DC PID controller, you should not program any other time consuming applications on this device, which may excessively lengthen the cycle time. A trouble-free function block operation is only ensured if the ratio of cycle time to scan time stated below is observed. For example, this may result in an intolerably long cycle time increase when the screen(s) is/are update on an MFD device. Divide the applications over two or several devices that you interconnect via easyNet.

5.13.2 Wiring of the function block

You wire the function block in the circuit diagram with its enable coil.

5.13.2.1 Coil

Parameters	Function
① FT..EN	EN=1 -> Activation of the function block function; EN=0 -> Reset of the function block, the output QV is set to 0.

5.13.2.2 Example of a smoothing filter:

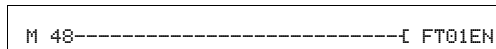

Figure 161: Wiring the function block coil

5.13.3 Parametric programming of the function block inputs/outputs

5.13.3.1 Parameters

```
FT17      +
>I1
>TG
>KP
QU>
```

When using the function block in the circuit diagram for the first time, use OK to automatically enter the general display of function block parameters, as shown in the figure on the left. Enter the function block settings here.

The display contains the following elements:

FT17	Function block: Signal smoothing, number 17
+	Parameter display: Call enabled
② >I1	Input value: -32768 - +32767
③ >TG	Recovery time: 0 - 65535 resolved in 100 ms Example: The value 250 is processed in the function block as 25 s.
④ >KP	Proportional gain: 0 - 65535 in %; Example: With KP=1500 the function block performs the calculation with $K_p=15$
⑤ QU>	Output value: -32768 - +32767, smoothed

The parameter set consists of:

Parameter Display

The display of the parameters during operation can be disabled. Additional information → section "4.9.2.1 Parameter assignment from the circuit diagram", page 191.

Parameters	Function
+	Parameters are displayed
-	Parameters are not displayed

This parameter is factory set to +.

5 Function blocks

5.13 FT, signal smoothing filter

Inputs

>I1: Assign the unfiltered input value to function block input >I1.

>TG: TG is used to define the recovery time.

>KP: The proportional gain at input >KP is used to adjust the input value.

You can assign the following operands to function block inputs >I1, >TG and >KP:

- Constant.
- Markers MD, MW, MB.
- Analog inputs IA01 to IA04:
 - IA01: Terminal I7.
 - IA02: Terminal I8.
 - IA03: Terminal I11.
 - IA04: Terminal I12.
- Analog output QA01.
- Output ...QV> of a different function block.

Output

Output FT..QV: Outputs the filtered value as an integer. You can assign the following operands to output ...QV>:

- Analog output QA01.
- Markers MD, MW, MB.

Memory requirement

The FT function block requires 56 bytes of memory plus 4 bytes per constant on the function block input.

Cycle time

mode	Cycle time [μ s]
-	60

5.13.4 Function of the function block

The signal to be smoothed is added via input I1. The delayed and smoothed output value is transferred to QV.

The “recovery time” T_g is used for setting the time in which the smoothing is to take place. The recovery time should not be greater than necessary otherwise the signals will be delayed more than is required by the smoothing (unavoidable side effect of signal smoothing).

The (proportional gain) input K_P is used to define a proportional gain factor. The input signal is multiplied with this factor. The value 100 corresponds to a K_P (factor) of 1.



The signal filter must be enabled so that it can work, i.e. the coil FT..EN must be active. If coil FT...EN is not active, the entire function block is deactivated and reset. The output value is set to zero.

If the function block is called for the first time, the output value is initialized with the input value when the device is started or after a reset. This speeds up the startup behavior of the function block.

5.13.4.1 Response of the function block

The step response of the FT function is an e function. After a time $t = T_g$ the normalized output value is $0.63 QV/QV_{max}$.

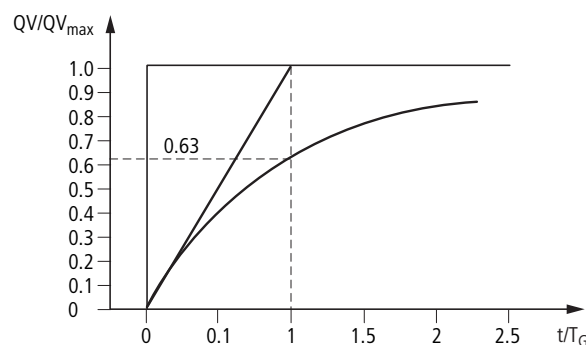

Figure 162: Figure: Step response of the FT function block



The function block updates the output value every time recovery time T_g expires.

5 Function blocks

5.13 FT, signal smoothing filter

The function block operates according to the following equation:

$$Y(t) = [T_a/T_g] \times [K_p \times x(t) - Y(t-1)]$$

$Y(t)$ = Calculated output value for scan time t .

T_a = Scan time.

T_g = Recovery time.

K_p = Proportional gain

$x(t)$ = Output value with scan time t .

$Y(t-1)$ = Output value with scan time $t - 1$

Scan time:

Scan time T_a depends on the set recovery time value.

Recovery time T_g	Scan time T_a
0.1 s - 1 s	10 ms
1 s - 6553 s	$T_g \times 0.01$

Cycle time to scan time: The scan time should be very large, approx. factor 10 compared to the cycle time, in order to ensure the correct ratio of cycle time t_{cyc} to scan time T_a . The scan time T_a is set indirectly via the value for the recovery time T_g (see above table).

The following applies: $t_{cyc} \ll T_a$

Some applications exist in which this condition cannot be reached. In this case you should set the cycle time using the ST function block (set cycle time) so that the scan time is an integer multiple of the cycle time.

$t_{cyc} \times n = T_a$ with $n = 1, 2, 3 \dots$

The function block always operates with a scan time that corresponds to an integer multiple of the cycle time. This can cause the set recovery time to be lengthened.

5.14 GT, get value from the NET

The GT (GET) function block is used to fetch a 32-bit value from the easyNet network. In the following the easyNet network is called the NET. The GET (GT) function block fetches its data automatically as soon as it is made available on the NET by another NET station with the PUT function block PT. MFD device allows the use of up to 32 GT function blocks.

5.14.1 Function block inputs/outputs

Function block GET GT1...GT32 (GeT)		Boolean inputs/outputs		Parameters	
Contact		Coil		Input value	Output value
Q1	Status "1" = a new transferred value is present ①				
					QV Value received from the NET network ②

Read the description of the inputs/outputs in the legend points in the following tables.

5.14.2 Wiring of the function block

You wire the function block with its signal contact in the circuit diagram.

5.14.2.1 Contact

A closed contact indicates for the duration of a processing cycle that new data was received via the NET and is present at the function block output QV:

Parameters	Function
① GT..Q1	Transferred value present at QV> (for one processing cycle)

5.14.2.2 Example of a GT function block:

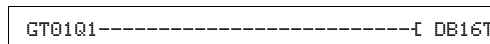

Figure 163: Wiring of the function block contact

The contact triggers a data function block.

5 Function blocks

5.14 GT, get value from the NET

5.14.3 Parametric programming of the function block inputs/outputs

5.14.3.1 Parameters

```
GT01 02 11 +
QU>
```

When using the function block in the circuit diagram for the first time, use OK to automatically enter the general display of function block parameters, as shown in the figure on the left. Enter the function block settings here. The display contains the following elements:

GT01	Function block: GT, number 01
02	The number (NET-ID) of the transmitting station, possible NET IDs: 01 - 08
11	Send function block of the sending station (here PT 11), possible function block numbers: 01 - 32
+	Parameter display: Call enabled
② QU>	32 Bit value received from the NET network, Value range: -2147483648 - 2147483647

The parameter set consists of:

Number of the sending station.

The NET can connect up to 8 stations that can exchange data with each other. The stations are identified by their station number. Further information on the easyNET network is provided in → Chapter 7 "The network easyNet" from page 437.

Number of the send function block

The sending station has 32 function blocks for transmitting 32-bit values to the network.

Parameter Display

The display of the parameters during operation can be disabled. Additional information → section "4.9.2.1 Parameter assignment from the circuit diagram", page 191.

Parameters	Function
+	Parameters are displayed
-	Parameters are not displayed

This parameter is factory set to +.

Output

The output provides the value transferred via the NET for one cycle. You can assign the following operands to output ...QV>:

- Analog output QA01.
- Markers MD, MW, MB.

Memory requirement

The GT function block requires 28 bytes of memory.

Cycle time

mode	Cycle time [μ s]
-	21

5.14.3.2 GET diagnostics

The GT function block only functions if the NET is operating correctly (→ section "9.3 Diagnostics", page 479).

5.14.4 Function of the function block

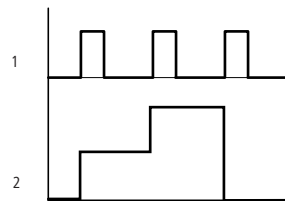

Figure 164: Signal diagram function block GT

1: GT..Q1

2: Value on GT...QV>



The GT function block has the value 0 when the power supply is switched on.

5 Function blocks
 5.15 HW, weekly timer

5.15 HW, weekly timer

An MFD device is provided with a real-time clock, which you can use in the circuit diagram as a weekly and year time switch.



The procedure for setting the time, → Section "8.5.1 Setting time and date", page 464.

5.15.1 Function block inputs/outputs

Weekly timer HW1...HW32 (Hora Week)							
Boolean inputs/outputs				Parameters			
Contact		Coil		Input value		Output value	
Q1	"1" if the on condition is fulfilled ①						
				DY1	Weekday Switch on time ②		
				DY2	Weekday Switch on time ③		
					On and Off date ④ + ⑤		

Read the description of the inputs/outputs in the following tables

5.15.2 Function

MFD device allows for the use of up to 32 function blocks of type weekly timer.

For each weekly timer four switch channels A, B, C and D are available. You can choose an on and off switching time for every channel. These channels of the weekly timer all act jointly on the contact Q1 that you include in the circuit diagram. The channels are set via the parameter display or easySoft.

5.15.3 Behavior in the event of a power failure

The time and date are backed up in the event of a power supply failure and continue to run. This means that it will continue to run in the event of a power failure, although the time switch relays will not switch. The contacts are kept open when de-energized. Information on the battery back-up time are provided on → section "11.3.5 Central processing unit, real-time clock/timing relay/memory", page 503.



The electronic clock module integrated into the MFD device works with a date range of 2001-01-01 to 2099-12-31



The operator can change the on or off time of a channel of a weekly timer function block during operation. The values can be entered via the buttons of an MFD-CP8... device from device version 05 or via an MFD-CP10... device. For this the weekly timer entry element must be used in a screen.

5.15.4 Wiring of the function block

The function block is wired in the circuit diagram with its contact.

5.15.4.1 Contact

The contact of the function block is evaluated in the circuit diagram. It closes for the on time and opens for the off time on the defined days.

Parameters	Function
① HW. .Q1	Switching contact; closes in the defined period

Example for a weekly timer:

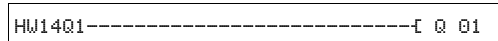

Figure 165: Wiring of the function block contact

The weekly timer controls a device output directly.

5.15.5 Parametric programming of the function block inputs/outputs

5.15.5.1 Parameters

```

HW14  A  +
>DY1
>DY2
>ON
>OFF
    
```

When using the function block in the circuit diagram for the first time, use OK to automatically enter the general display of function block parameters, as shown in the figure on the left. The function block settings are carried out here. The display contains the following elements:

HW14	Function block: Weekly timer, number 14
CSA	Time switch channel: A
+	Parameter display: Call enabled
② >DY1	Day 1: Day on which the switch-on is to occur for the first time (start of time period).
③ >DY2	Day 2: Day on which the switch-off is to occur for the last time (end of time period).
④ >ON	Closing delay: 00:00 - 23:59, No on switching: --:--
⑤ >OFF	Break time: 00:00-23:59, No off switching: --:--

The parameter set consists of:

Channel

For each weekly timer channels A, B, C and D are available. These channels all act jointly on the contact Q1 of the weekly timer.

Parameters	Function
CSA	Display of the parameters: Channel A
B	Display of the parameters: Channel B
C	Display of the parameters: Channel C
D	Display of the parameters: Channel D

Parameter Display

The display of the parameters during operation can be disabled. Additional information → section "4.9.2.1 Parameter assignment from the circuit diagram", page 191.

Parameters	Function
+	Parameters are displayed
-	Parameters are not displayed

This parameter is factory set to +.

Day 1 and day 2

These parameters DY1/DY2 are used to limit the period in which the output HW..Q1 is switched.

Enter either a period of several days or only of one day:

Entry	On and off time
MO	Monday
TU	Tuesday
WE	Wednesday
TH	Thursday
FR	Friday
SA	Saturday
SO	Sunday
--	No day

Examples:

```
HW10  A  +
>DY1 MO
>DY2 FR
>ON
>OFF
```

- Monday to Friday

```
HW14  D  +
>DY1 MO
>DY2 --
>ON
>OFF
```

- Only on Monday

On and off time

The ON/OFF parameters are used for setting the on and off time.

Memory requirement

The "weekly timer" block requires 68 bytes of memory plus 4 bytes of memory for each channel used.

Cycle time

mode	Cycle time [µs]
-	45

5.15.6 Operation of the function block

The switching points are defined according to the parameters entered.

MO to FR: on weekdays Mo, Tu, We, Th, Fr

ON 10:00, OFF 18:00: On and off time on each weekday.

MO: Every Monday

ON 10:00: On time

SA: Every Saturday

OFF 18:00: Off time

Switching on working days

The weekly timer HW01 switches on from Mondays to Fridays with channel:

- A between 6:30 and 9:30.
- B between 17:00 and 22:30.

<pre>HW01 A + >DY1 MO >DY2 FR >ON 06:30 >OFF 09:30</pre>	<pre>HW01 B + >DY1 MO >DY2 FR >ON 17:00 >OFF 22:30</pre>
--	--

Switching at the weekend

The weekly timer HW02 switches on at 16:00 on Friday and switches off at 6:00 on Monday.

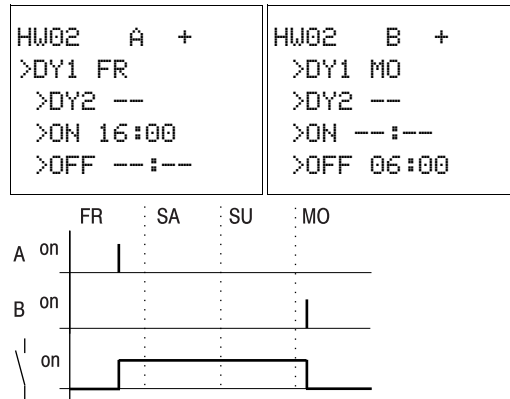

Figure 166: Signal diagram of "weekend"

Overnight switching

The weekly timer HW03 switches on overnight at 22:00 Monday and switches off at 6:00 on Tuesday.

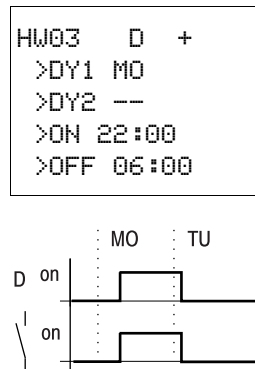

Figure 167: Signal diagram for night switching



If the break time is before the closing delay, MFD device will switch off on the following day.

Time overlaps

The weekly timer settings of a time switch overlap. The clock switches on at 16:00 on Monday, whereas on Tuesday and Wednesday it switches on at 10:00. The off time for Mondays to Wednesdays is 22:00.

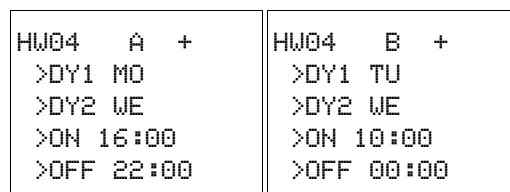

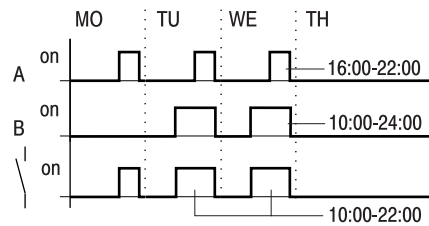

Figure 168: Signal diagram of overlaps



Closing delay and break time of the output Q1 always follow the channel which switches first.
In other words, the first closing delay at one of the four channels switches output Q1 to 1.
The first break time of a channel switches output Q1 to 0.
If the on time and off time are the same, the output Q1 is switched off.

Response in the event of a power failure

The power is removed between 15:00 and 17:00. The relay drops out and remains off, even after the power returns, since the first off time was at 16:00.

HW05	A	+	HW05	B	+
>DY1	MO		>DY1	MO	
>DY2	SU		>DY2	SU	
>OFF	16:00		>ON	12:00	
			>OFF	18:00	



When it is switched on, MFD-device always updates the switching state on the basis of all the available switching time settings.

24 hour switching

The time switch is to switch for 24 hours. Switch on at 00:00 on Mondays and switch off at 00:00 on Tuesdays.

HW20	A	+	HW20	B	+
>DY1	MO		>DY1	TU	
>DY2			>DY2		
>ON	00:00		>ON		
>OFF			>OFF	00:00	

5.16 HY - Year Time Switch

An MFD device is fitted with a real-time clock that you can use in the circuit diagram as a year and weekly timer.



The procedure for setting the time → section “8.5.1 Setting time and date”, page 464.

Year time switch HY1...HY32 (Hora Year)			
Boolean inputs/outputs		Parameters	
Contact	Coil	Input value	Output value
Q1	"1" if the on condition is fulfilled ①		On/off date ②+③

Read the description of the inputs/outputs in the following tables

5.16.1 Function

If you have to implement special on and off switching functions on public holidays, vacations, company holidays, school holidays and special events, these can be implemented easily with the year time switch.

MFD device allows for the use of up to 32 function blocks of type year time switch.

For each year time switch four channels A, B, C and D are available. You can choose an on and off switching time for every channel. These channels of a year time switch all act jointly on the contact Q1 that you include in the circuit diagram. The channels are set via the parameter display or easySoft.

The year time switch can:

- Switch at recurring intervals by switching on and off for individual days, months, or years.
- Switch for continuous periods of time by remaining continuously switched on from the start of any user-defined day until the end of any user-defined day, month, or year.



The parameters for the switch-on and switch-off times for recurring intervals are configured in one single channel for each. The parameters for the switch-on and switch-off times for a continuous period of time are configured in two neighbouring channels. If you enter the ON information on channel A, the OFF information must be entered on channel B; likewise, if the ON information is on channel B, the OFF information must be on channel C.

5.16.2 Behavior in the event of a power failure

The time and date are backed up in the event of a power supply failure and continue to run. This means that it will continue to run in the event of a power failure, although the time switch relays will not switch. The contacts are kept open when de-energized. Information on the battery back-up time are provided on → section “11.3.5 Central processing unit, real-time clock/timing relay/memory”, page 503.



The electronic clock module integrated into the MFD device works with a date range of 2001-01-01 to 2099-12-31



The user can change the on and off time of a channel of the year time switch function block during operation. The values can be entered via the buttons of an MFD-CP8... device from device version 05 or an MFD-CP10... device. For this the entry element (→ section “6.4.21 Year time switch entry”, page 414) must be used in a screen.

5.16.3 Wiring of the function block

The function block is wired in the circuit diagram with its contact.

5.16.3.1 Contact

The contact closes each day for the on time and opens for the off time.

Parameters	Function
① HY . .Q1	Switching contact; closes in the defined period

5.16.3.2 Example for a year time switch:

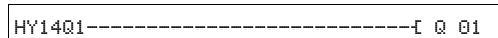

Figure 169: Wiring of the function block contact

The year time switch controls a device output directly.

5.16.4 Parametric programming of the function block inputs/outputs

5.16.4.1 Parameters

```
HY14 B +
>ON
>OFF
```

When using the function block in the circuit diagram for the first time, use OK to automatically enter the general display of function block parameters, as shown in the figure on the left. Enter the function block settings here. The display contains the following elements:

5 Function blocks

5.16 HY - Year Time Switch

HY14	Function block: Year time switch, number 14
B	Time switch channel: B
+	Parameter display: Call enabled
② >ON	On date
③ >OFF	Off date

The parameter set consists of:

Channel

For each year time switch function block, you can configure the parameters for the A, B, C, and D channels that act jointly on contact Q1 of this function block.

Parameters	Function
CSA	Display of the parameters: Channel A
B	Display of the parameters: Channel B
C	Display of the parameters: Channel C
D	Display of the parameters: Channel D

Parameter Display

The display of the parameters during operation can be disabled. Additional information → section "4.9.2.1 Parameter assignment from the circuit diagram", page 191.

Parameters	Function
+	Parameters are displayed
-	Parameters are not displayed

This parameter is factory set to +.

On and off date

Use these parameters to set the data for on and off switching in the format DD.MM.YY.

5.16.4.2 Example

Day.Month.Year: 11.11.07

Parameters	Function
>ON	On date
>OFF	Off date

5.16.4.3 Memory requirement

The year time switch function block requires 68 bytes of memory plus 4 bytes of memory for each channel used.

5.16.4.4 Cycle time

mode	Cycle time [µs]
-	61

5.16.5 How the function block works

The year time switch can switch ranges, individual days, months, years or combinations of all three.

```
HY01 A    +
>ON  --.--.08
>OFF --.--.12
```

Years

Switching at 00:00:

- On on 01.01.2008 and
- Off on 01.01.2013.

```
HY01 A    +
>ON  --.04.--
>OFF --.10.--
```

Months

Switching at 00:00:

- On on 01 April every year.
- Off on 01 November every year.

```
HY01 A    +
>ON  02.--.--
>OFF 25.--.--
```

Days

Switching at 00:00:

- On on the 2nd day of every month.
- On on the 26th day of every month.

5.16.6 Entry rules

The contact switches (ON to OFF)

- in the years.
- in the defined months.
- on the entered days.

CAUTION

The year time switch only operates correctly if you observe the following rules:

- The On year must be before the Off year,
- ON and OFF times must be specified the same in pairs, for example:
 - ON = Day/--/--, OFF = Day/--/--
 - ON = --/--/Year, OFF = --/--/Year,
 - ON = --/Month/Year, OFF = --/Month/Year
 - ON = Day/Month/Year, OFF = Day/Month/Year
- Normally, the ON day should be before the OFF day; otherwise, the exception described on Example 8 (→ section " Example 8: Selecting a time range of two days spanning the turn of the year (2-channel)", page 289) on applies.

5 Function blocks

5.16 HY - Year Time Switch

The following nine entry rules are possible (XX = position used)

```
HY01 A    +
>ON XX.--.--
>OFF XX.--.--
```

Rule 1

ON: Day
OFF: Day

```
HY01 A    +
>ON --.XX.--
>OFF --.XX.--
```

Rule 2

ON: Month
OFF: Month

```
HY01 A    +
>ON --.--.XX
>ON --.--.XX
```

Rule 3

ON: Year
OFF: Year

```
HY01 A    +
>ON XX.XX.--
>OFF XX.XX.--
```

Rule 4

ON: Day/month
OFF: Day/month

```
HY01 A    +
>ON --.XX.XX
>OFF --.XX.XX
```

Rule 5

ON: Month/year
OFF: Month/year

```
HY01 A    +
>ON XX.XX.XX
>OFF XX.XX.XX
```

Rule 6

ON: Day/month/year
OFF: Day/month/year

```
HY01 A    +
>ON XX.XX.--
>OFF --.--.--
```

Rule 7

Two-channel
Channel A ON: Day/month

```
HY01 B +
>ON --.--.--
>OFF XX.XX.--
```

Channel B OFF: Day/month

```
HY01 C +
>ON XX.XX.XX
>OFF --.--.XX
```

Rule 8

Two-channel
Channel C ON: Day/Month/Year
Channel D OFF: Day/month/year

```
HY01 D +
>ON --.--.XX
>ON --.--.XX
```

With this rule, the same year number must be entered in each channel in the ON and OFF entry area.

Rule 9

Overlapping channels: The first ON date switches on and the first OFF date switches off.

5.16.7 Sample parameter configurations

5.16.7.1 Configuring the parameters for recurring intervals

```
HY01 A    +
>ON  --.--.10
>OFF --.--.11
```

Example 1: Selecting year range (1-channel)

The year time switch HY1 is required to switch on at 00:00 on January 1 2010 and stay on until 00:00 January 1 2012.

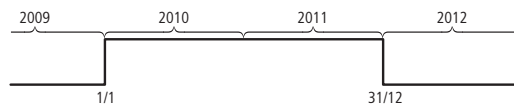

Figure 170: Select year range

```
HY02 A    +
>ON  __.03.--
>OFF --.09.--
```

Example 2: Selecting month ranges (1-channel)

The year time switch HY02 is required to switch on at 00:00 on March 1 and stay on until 00:00 October 1.

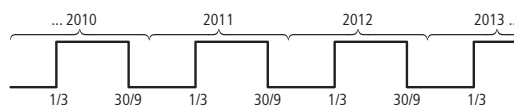

Figure 171: Select month range

```
HY03 A    +
>ON  01.--.--
>OFF 28.--.--
```

Example 3: Selecting day ranges (1-channel)

The year time switch HY03 is required to switch on at 00:00 on day 1 of each month and switch off at 00:00 on day 29 of each month.

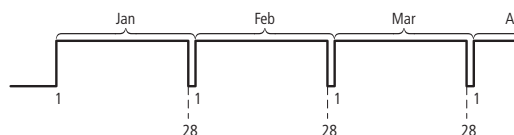

Figure 172: Select day range

```
HY04 A    +
>ON  25.12.--
>OFF 26.12.--
```

Example 4: Selecting public holidays (1-channel)

The year time switch HY04 is required to switch on at 00:00 on day 25.12 of each year and switch off at 00:00 on day 27.12 of each year, "Christmas program".

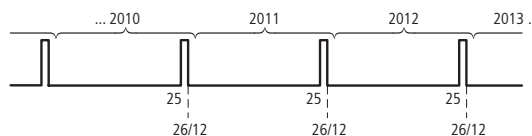

Figure 173: Select public holiday

```
HY05 A    +
>ON  09.06.--
>OFF 16.10.--
```

Example 5: Specific days of specific months (1-channel)

The year time switch HY05 is required to switch on at 0:00 on day 9 of months 6, 7, 8, 9 and 10 of each year and switch off at 00:00 on day 17 of the month.

5 Function blocks
 5.16 HY - Year Time Switch

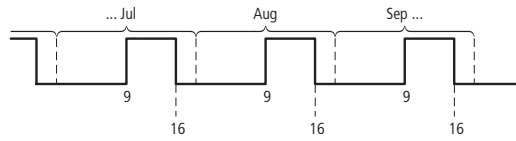

Figure 174: Chose specific days of specific months

5.16.7.2 Configuring the parameters for continuous periods of time

The following examples show how to configure the parameters for continuous periods of time in which the time switch remains continuously switched on. The parameter definition is carried out in pairs on two adjacent channels.

Example 6: Time range for each year (2-channel)

The year time switch HY01 is required to switch on at 00:00 on day 02.05 of each year and stay on continuously until 00:00 on 1.11 of each year, "Open air season".

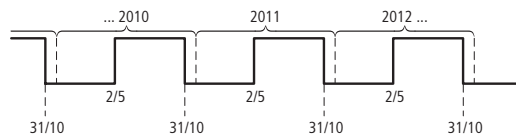

Figure 175: Select time range for each year

Parameter settings of the year time switch HY01:

```
HY01  A    +
>ON  02.05.--
>OFF --.---.--
```

ON/OFF: First/last switch-on years are not restricted in this case.

```
HY01  B    +
>ON  --.---.--
>OFF 31.10.--
```

ON/OFF: First/last switch-off years are not restricted in this case.

Example 7: Selecting a time range for a limited number of years (2-channel)

The HY01 year time switch should switch on at 00:00, on 05/02, in the years 2011 and 2012, and remain switched on until 00:00 on 11/1 in each case.

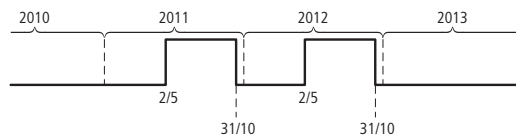

Figure 176: Select a time range for a limited number of years

Parameter settings of the year time switch HY01:

```

HY01  A    +
>ON  02.05.11
>OFF --.--.12
    
```

ON/OFF: First/last switch-on year.

```

HY01  B    +
>ON  --.--.11
>OFF 31.10.12
    
```

ON/OFF: First/last switch-off year.

Example 8: Selecting a time range of two days spanning the turn of the year (2-channel)

The HY01 year time switch should switch on at 00:00 on 12/31 of every year and remain continuously switched on until 00:00 on 02/01 of every year.

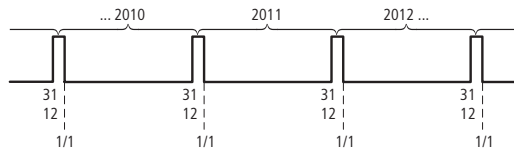

Figure 177: Select a time range of two days spanning the turn of the year

Parameter settings of the year time switch HY01:

```

HY01  A    +
>ON  31.12.--
>OFF --.--.--
    
```

ON/OFF: First/last switch-on years are not restricted in this case.

```

HY01  B    +
>ON  --.--.--
>OFF 01.01.--
    
```

ON/OFF: First/last switch-off years are not restricted in this case.

Example 9: Selecting a time range of two days spanning the turn of the year on 2010/2011, 2011/2012 (2-channel)

The HY01 year time switch should switch on at 00:00 on 12/31 of 2010 and remain switched on until 00:00 on 01/02 of 2011, and switch on at 00:00 on 12/31 of 2011 and remain switched on until 00:00 on 01/02 of 2012.

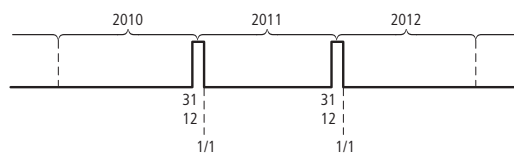

Figure 178: Select a time range of two days spanning the turn of the year

5 Function blocks

5.16 HY - Year Time Switch

Parameter settings of the year time switch HY01:

```

HY01  A    +
>ON  31.12.10
>OFF --.--.11
  
```

```

HY01  B    +
>ON  --.--.11
>OFF 01.01.12
  
```

ON/OFF: First/last switch-on year.

ON/OFF: First/last switch-off year.

Example 10: Overlapping time ranges (2-channel)

This example shows how to configure the parameters for continuous overlapping time ranges on adjacent channels.

The HY01 year time switch, channel C, switches on at 00:00 on the third of months 5, 6, 7, 8, 9, 10 and remains switched on until 00:00 on the 26th of these months.

The HY01 year time switch, channel D, switches on at 00:00 on the second of months 6, 7, 8, 9, 10, 11, 12 and remains switched on until 00:00 on the 18th of these months.

Parameter settings of the year time switch Y01

```

HY01
C    +
ON  03.05.--
OFF 25.10.--
  
```

①

```

HY01
D    +
ON  02.06.--
OFF 17.12.--
  
```

②

Total result corresponding to the channel configurations and behavior of contact Q1 in this example:

The time switch switches on at 00:00 on 3 May and stays on until 00:00 on 26 May.

In June, July, August, September, October, the time switch will switch on at 00:00 on day 2 of the month and switch off at 00:00 on day 18.

In November and December, the time switch will switch on at 00:00 on the second of the month and switch off until 00:00 on the 18th. The following note explains this switching behavior.



Switching behaviour with overlapping channel settings:

If parameterized ranges overlap, the year time switch switches the contact on with the first detected ON, irrespective of which channel supplies this ON signal. In the same way, the year time switch switches the contact off with the first detected OFF, irrespective of whether another channel still supplies the ON signal!

5.17 JC, conditional jump

With function block JC.. you can branch off forwards to a jump label (Label, LB) within the function block list to skip several function blocks.

You use LB.. (jump label) as the jump destination. The JC and LB function blocks are used in the circuit diagram.

MFD device allows up to 32 conditional jumps.



For each JC.. function block, an LB.. function block must be provided as the jump label. The JC.. and LB.. function blocks must always be used in pairs. JC01 is always assigned the jump label LB01.



The description of the LB.. function block is provided on → section “5.18 LB, jump label”, page 294.

5.17.1 Function block inputs/outputs

Arithmetic JC1...JC32 (Jump Conditional)			
Boolean inputs/outputs		Parameters	
Contact	Coil	Input value	Output value
E1	Error output ①		
	EN	EN=1 -> activation of jump function ②	

Read the description of the inputs/outputs in the legend points in the following tables.

5.17.2 Wiring of the function block

You wire the function block in the circuit diagram with its enable coil JC..EN. It can be wired directly to the device terminals I1 to I12 or associated internally.

5.17.2.1 Coil

Parameters	Function
② JC..EN	Activation of the function block

5 Function blocks
5.17 JC, conditional jump

5.17.2.2 Contact

The contact indicates a fault if there is not an associated jump present or is in front of the jump location (backward jump).

Parameters	Function
① JC..E1	Error message

5.17.2.3 Example of a conditional jump:

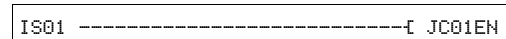
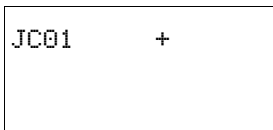

Figure 179: Wiring the enable coil

5.17.3 Parametric programming of the function block inputs/outputs

5.17.3.1 Parameters



When using the function block in the circuit diagram for the first time, use OK to automatically enter the general display of function block parameters, as shown in the figure on the left. Enter the function block settings here. The display contains the following elements:

JC01	Function block: Conditional jump, number 01
+	Without function

5.17.3.2 Memory requirement

The conditional jump function block requires 20 bytes of memory.

5.17.4 Function of the function block

If the JC..EN enable coil is active, the program jumps forwards over one or several function blocks. The next function block to be processed is then the first to follow the LB jump label in the function block diagram. If the JC..EN enable coil is not active, the program is processing the next function block that is added in the function block diagram behind JC...

In the function block list a jump label must be positioned downstream, i.e. towards the end of the list when viewed from associated function block "conditional jump". If it is placed in front of the associated jump location (backward jump), the program branches to the end of the function block list and fault contact JC..E1 of function block "conditional jump" closes. If no associated jump label is set in the function block list, the program jumps to the end of the list and fault contact JC..E1 also closes.

5.17.4.1 Example

A jump is to be made downstream of a table function block TB01 when marker M01 has the state 1.

```
M 01-----[ JC01EN
```

Figure 180: Example of conditional jump

JC01	+
TB01	-
LB01	
L:031	B:6488

Enter the function block editor via <PROGRAM..., PROGRAM -> FUNCTION RELAYS>.

- ▶ In this menu use the cursor buttons ^v to move to the location from where the jump is to be made and press OK.
- ▶ Then use the cursor keys ^v to select function block JC01 and close the input dialog with two clicks on OK.
- ▶ Insert table function block TB01 into then next position in the function block list, configure it and complete your input with ESC.
- ▶ Use the cursor buttons ^v to navigate to the next position in the function block list and insert the jump label LB01 described below there.

During processing, the program branches to jump label LB01 for as long as JC01EN is 1.



For subsequently inserting function block JC.. in the function block list to skip other, existing function blocks, the use of the easySoft-Pro programming software is recommended. This software allows function blocks to be moved into any position.



For subsequently inserting function block JC.. in the function block list to skip other, existing function blocks, the use of the easySoft programming software is recommended. This software allows function blocks to be moved into any position.

5 Function blocks

5.18 LB, jump label

5.18 LB, jump label

Within the function block list jump label LB.. is the jump target for a conditional jump with function block JC.. . The function blocks JC and LB are always used in pairs in the circuit diagram.

MFD device allows the use of up to 32 jump labels.

5.18.0.1 Function Block

As the LB.. function block is simply only a jump destination, it does not require any association or parameters in the circuit diagram. It does not have any coils or contacts and is simply placed at the required position in the function block list.



A corresponding JC.. function block (conditional jump) must exist for every LB.. function block. For example, the jump label LB01 belongs to the conditional jump JC01.

In the function block list a jump label must be positioned downstream, i.e. towards the end of the list when viewed from associated function block "conditional jump". If it is placed in front of the associated jump location (backward jump), the program branches to the end of the function block list and fault contact JC..E1 of function block "conditional jump" closes. If no associated jump label is set in the function block list, the program jumps to the end of the list and fault contact JC..E1 also closes.

Enter the function block editor from the main menu via <PROGRAM... -> PROGRAM -> FUNCTION RELAYS>.

- ▶ In this menu use the cursor buttons $\wedge \vee$ to move to the location to which the jump is to be made and press OK.
- ▶ Then use the cursor keys $\wedge \vee$ to select function block LB.. and close the input dialog with two clicks on OK.

The description of the JC.. conditional jump function block is provided in \rightarrow Chapter 5 "Function blocks" from page 291. This also contains an example.

5.19 LS, value scaling

The function block enables you to convert values from one value range to another one.

The function block scales values at input LS..I1 according to the mathematical relationship you have set, and then outputs the result as a larger or smaller value at the output at LS..QV. The mathematical relationship is based on a straight line defined by the coordinate pairs X1, Y1 and X2, Y2 (see under "The mathematical relationship is:").

A typical application is the conversion of values, such as 0...20 mA to 4...20 mA. A MFD device is provided with 32 value scaling function blocks.

5.19.1 Function block inputs/outputs

Value scaling LS01...LS32 (Linear Scaling)							
Boolean inputs/outputs				Parameters			
Contact		Coil		Input value		Output value	
		EN	Activate the function block ①				
				I1	Input value ②		
				X1	Support point 1 ③		
				Y1	Support point 2 ④		
				X2	Support point 1 ⑤		
				Y2	Support point 1 ⑥		
						QV	Scaled output value ⑦

Read the description of the inputs/outputs in the legend points in the following tables.

5.19.2 Wiring of the function block

You wire the function block in the circuit diagram with an enable coil.

5.19.2.1 Coil

The enable coil LS..EN activates the function block in the standard circuit diagram; when the coil is deactivated, the output QV> is set to 0.

Parameters	Function
① LS..EN	Enables the function block

5.19.2.2 Example of a value scaling function block

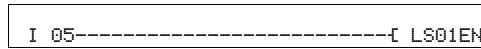
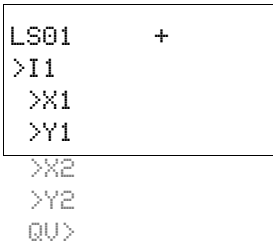

Figure 181: MFD circuit diagram with enabling of value scaling function block

5.19.3 Parametric programming of the function block inputs/outputs

5.19.3.1 Parameters



When using the function block in the circuit diagram for the first time, use OK to automatically enter the general display of function block parameters, as shown in the figure on the left. Enter the function block settings here. The display contains the following elements:

LS01	Function block: Value scaling, number 01 Value range: -2147483648 - 2147483647, valid for all values.
+	Parameter display: Call enabled
② >I1	Input value
③ >X1	Lower value of source range,
④ >Y1	Lower value of target range
⑤ >X2	Upper value of source range
⑥ >Y2	Upper value of target range
⑦ QU>	Output value, scaled

Parameter Display

The display of the parameters during operation can be disabled. Additional information → section “4.9.2.1 Parameter assignment from the circuit diagram”, page 191.

Parameters	Function
+	Parameters are displayed
-	Parameters are not displayed

This parameter is factory set to +.

Inputs

>I1: Assign the unscaled value to function block input >I1.

>X1 and >Y1: You define the first support point of the straight line at function block inputs >X1 and >Y1.

>X2 and >Y2: The second pair of values at function block inputs >X2 and >Y2 determines the second support point of the straight line.

You can assign the following operands to function block inputs >I1, >X1, >Y1, >X2 and >Y2:

- Constant
- Markers MD, MW, MB
- Analog inputs IA01 to IA04:
 - IA01: Terminal I7
 - IA02: Terminal I8
 - IA03: Terminal I11
 - IA04: Terminal I12
- Analog output QA01
- Output ...QV> of a different function block

Output

The output QV> supplies the scaled value as an integer.

You can assign the following operands:

- Markers MD, MW, MB
- Analog output QA01

Memory requirement

The function block requires 64 bytes of memory plus 4 bytes per constant at the input.

Cycle time

mode	Cycle time [μs]
-	224

5.19.4 Function of the function block



The scaling function block must be enabled via coil LS..EN = 1 in order for it to work. If the coil LS..EN is not active, the entire function block is deactivated and reset. The output value is set to zero.

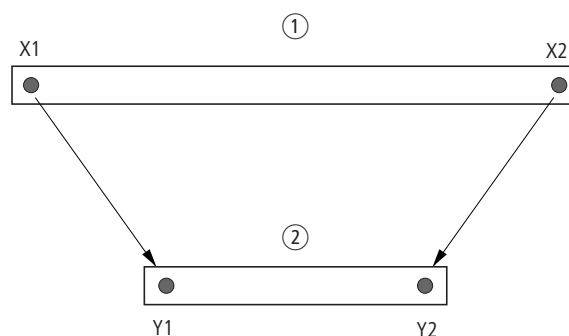

Figure 182: Value scaling function block – reduce value range

- ① Source Range
- ② Destination Range

5 Function blocks

5.19 LS, value scaling

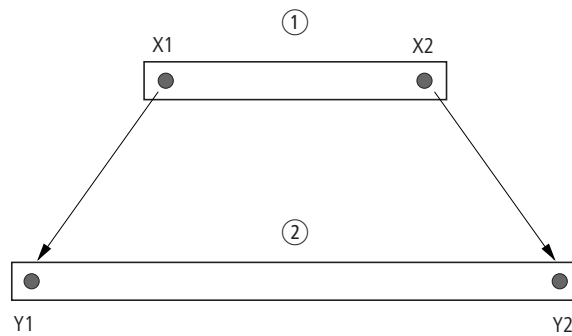

Figure 183: Function block value scaling - increasing value range

- ① Source Range
- ② Destination Range

The mathematical relationship is follows:

- $Y = m \times X + Y_0$
- $m = (Y_2 - Y_1) / (X_2 - X_1)$
- $Y_0 = ((X_2 \times Y_1) - (X_1 \times Y_2)) / (X_2 - X_1)$

m = gradient

Y_0 = Y offset when $X = 0$

X_1, Y_1 = First value pair

X_2, Y_2 = Second value pair

g = Straight line with positive gradient

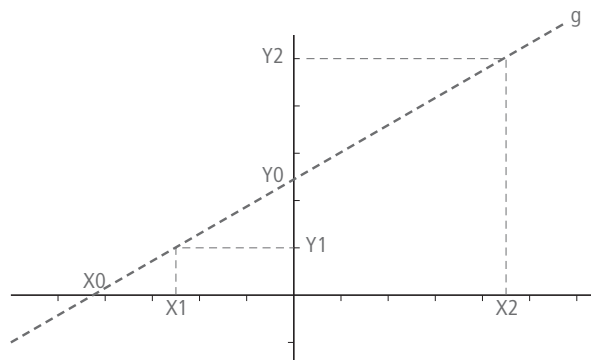

Figure 184: Mathematical interrelationship

5.19.5 Application example

The signal of measuring value converters with a current output reaches the input LS..I1 of the scaling function block via the output of a multiplexer function block. The measuring value is between:

- 4 mA, corresponds to measured value 0 and
- 20 mA, corresponds to maximum measured value.

The task of the function block is to adjust the value in order to show it at output LS..QV as a value between 0 and 100 %.

The transferred measured value has a resolution between 0...1023 bits. This means:

- The minimum measured value is $1023 \text{ bits} \times 4 \text{ mA} / 20\text{mA} = 205 \text{ bit}$.
- The maximum measured value is at 1023 bits.

The parameter display and the parameter set for function block LS01 is shown on the left. After the function block number 01 is defined, you enter here the following values:

```

LS01      +
>I1 MX01QV
>X1 +205
>Y1 +0
>X2 +1023
>Y2 +100
QV> MD01
    
```

- the operand MX01QV with the value to be scaled.
- the first support point of the straight line with its zero point coordinates:
 - X1 = 205
 - Y1 = 0 and
- the second support point of the straight line with its maximum point coordinates:
 - X1 = 1023
 - Y1 = 100
- the transfer marker MD01 with the scaled value.

5 Function blocks
 5.20 MR, master reset

5.20 MR, master reset

The master reset function block allows you to reset the states of the markers and all outputs to 0 with a single command. The operating mode of the function block allows you to set whether only the outputs, only the markers or outputs and markers are to be reset.

MFD device allows the use of up to 32 master reset function blocks.

5.20.1 Function block inputs/outputs

Master reset MR1...MR32 (Master Reset)			
Boolean inputs/outputs		Parameters	
Contact	Coil	Input value	Output value
Q1	Trigger confirmation ①		
	T_	Trigger Signal ②	

Read the description of the inputs/outputs in the legend points in the following tables.

5.20.2 Wiring of the function block

You wire the function block in the circuit diagram with its trigger coil.

5.20.2.1 Coil

Parameters	Function
② MR..T_	Function block reset on rising edge

5.20.2.2 Contact

A closed contact indicates:

Parameters	Function
① MR..Q1	1 on activated trigger signal

5.20.2.3 Example of a master reset function block:

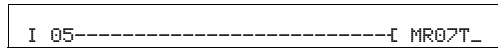

Figure 185: Wiring the trigger coil

The trigger coil is connected to a device input.

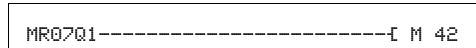
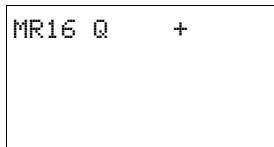

Figure 186: Wiring the contacts

The message of the function block is sent to a marker.

5.20.3 Parametric programming of the function block inputs/outputs

5.20.3.1 Parameters



When using the function block in the circuit diagram for the first time, use OK to automatically enter the general display of function block parameters, as shown in the figure on the left. Enter the function block settings here. The display contains the following elements:

MR16	Function block: Master reset, number 16
Q	Operating mode: Reset outputs
+	Parameter display: Call enabled

The parameter set consists of:

Operating Mode

The operating mode setting allows you to set whether markers, outputs or both are to be reset.

Parameters	Function
Q	Resets the outputs used in the circuit diagram Q., *Q., QA., S., *S., *SN.; * = NET-ID
M	Acts on the marker range MD01 to MD96.
ALL	Acts on the operands specified above under Q and M that are used in the circuit diagram.

This parameter is factory set to Q.

Parameter Display

The display of the parameters during operation can be disabled. Additional information → section “4.9.2.1 Parameter assignment from the circuit diagram”, page 191.

Parameters	Function
+	Parameters are displayed
-	Parameters are not displayed

This parameter is factory set to +.

Memory requirement

The master reset function block requires 20 bytes of memory.

Cycle time

mode	Cycle time [μs]
Q	47
M	185
ALL	217

5.20.4 Function of the function block

All outputs or the markers are set to 0 in accordance with the operating mode when a rising edge is detected on the trigger coil.



Carry out the master reset function block so that all data ranges are cleared reliably. Otherwise subsequent function blocks may overwrite the data ranges.

The contact MR1..Q1 assumes the state of its own trigger coil and confirms the reset operation.

5.21 MX, data multiplexer

This function block is available for easy800 from device version 07 and for MFD-CP10... devices. The data multiplexer function block allows you to select a value from eight input values MX..I1 to MX..I8 as if using a mode selector switch. The function block provides this value after transferring it to its output MX..QV.

A MFD device allows the use of up to 32 data multiplexers.

5.21.1 Function block inputs/outputs

Data multiplexer MX01...MX32 (MultipleXer)							
Boolean inputs/outputs				Parameters			
Contact		Coil		Input value		Output value	
E1	Error output ①						
		EN	Activation of the function block ②				
				K	Channel number ③		
				I1-I8	Input value, channel 1-8 ④		
						QV	Output value of the selected channel ⑤

Read the description of the inputs/outputs in the legend points in the following tables.

5.21.2 Wiring of the function block

The function block is enabled via the coil in the circuit diagram and its contact is then queried as an error output.

5.21.2.1 Coil

When the enable coil MX..EN is set to 1, it switches the selected input Ix to output QV. This switch operation is retained for as long as MX..EN is 1. When the MX..EN state changes from 1 to 0, output QV is reset to 0.

Parameters	Function
② MX..EN	Enables the function block

5.21.2.2 Contact

A closed contact indicates a filter:

Parameters	Function
① MX..E1	Fault, e.g. invalid channel setting

5.21.2.3 Example

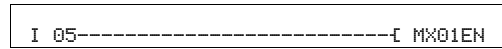

Figure 187: Wiring the enable coil

Its coil MX01EN is directly connected to the device terminal I05.

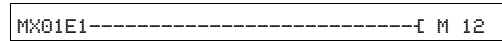

Figure 188: Wiring of the function block contact MX01E1

The function block contact MX01E1 (fault message) is associated with the marker M12.

5.21.3 Parametric programming of the function block inputs/outputs

5.21.3.1 Parameters

```

MX01      +
>K
>I1
>I2

>I3
>I4
>I5
>I6
>I7
>I8
QV>
    
```

When using the function block in the circuit diagram for the first time, press OK to enter the general display of the function block parameters automatically, as shown in the figure on the left for an on-delayed timing relay. Enter the function block settings here. The display contains the following elements:

MX01	Function block; Data multiplexer, number 01
+	Parameter display: Call enabled
③ >K	Channel number (0 - 7)
④ >I1 >I8	Input channels I1 to I8, value range: - 2147483648 - 2147483647
⑤ QV>	Supplies the selected input value

The parameter set consists of:

Parameter Display

The display of the parameters during operation can be disabled. Further information on this is provided → Section "4.9.2.1 Parameter assignment from the circuit diagram" on page 191.

Parameters	Function
+	Parameters are displayed
-	Parameters are not displayed

This parameter is factory set to +.

Inputs

>K: Function block input >K is used to define the input channel to be supplied at function block output QV>.

>I1 to >I8: Assign the values to function block inputs >I1 to >I8 that you wish to output on function block output QV>.

You can assign the following operands to the function block inputs >K and >I1 to >I8:

- Constant.
- Markers MD, MW, MB.
- Analog inputs IA01 to IA04:
 - IA01: Terminal I7.
 - IA02: Terminal I8.
 - IA03: Terminal I11.
 - IA04: Terminal I12.
- Analog output QA01.
- Output ...QV> of a different function block.

Output

The output QV> supplies the value present at the selected input channel.

You can assign the following operands to output MX..QV:

- Analog output QA01.
- Markers MD, MW, MB.

Memory requirement

The data multiplexer function block requires 96 bytes of memory plus 4 bytes per constant at the function block inputs.

5.21.4 Function of the function block

The multiplexer is active if the Enable coil MX..EN is set to 1.

You use the channel number input MX..K to set which input is to be switched through to the output. The channel number input switches the input values in their order, i.e.:

- Channel number 0 supplies the input MX..I1 to MX..QV.
- Channel number 7 supplies the input MX..I8 to MX..QV.

You can also change the channel number when the EN input is set.

When EN = 1, the value at the selected input Ix is continuously output and refreshed with every processing cycle.

The fault contact MX..E1 closes if an invalid parameter is present at the channel number input MX..K.

5 Function blocks

5.21 MX, data multiplexer

5.21.4.1 Example

A drive is required to run at a fixed speed and at three dependent speeds.

It receives the setting from a multiplexer function block.

MB08 defines the number of the channel that is to reach the output. The fixed speed is set as a constant at input MX01I1, the subsequent inputs are assigned the variable values from markers MB01 to MB03. The setpoints at output MX01QV of the function block are output at MB04.

The function block is first activated in the circuit diagram by marker M33. The following figure shows the the association.

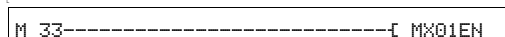

Figure 189: Circuit diagram for enabling the data multiplexer function block

```
MX01      +
>K MB08
>I1 +40
>I2 MB01
```

```
>I3 MB02
>I4 MB03
>I5
>I6
>I7
>I8
QU> MB04
```

Enter the parameters of the function block as shown on the left.

5.22 NC, numerical converter

The numerical converter function block is used to convert a value of:

- BCD in binary value.
- Binary value in BCD.

The binary value is further processed in the device. For example it can be added to a value. The binary value is displayed in the simulator as a decimal value. MFD device allows the use of up to 32 numerical converters.

5.22.1 Function block inputs/outputs

Numerical converter NC1...NC32 (Numeric Coding)							
Boolean inputs/outputs				Parameters			
Contact		Coil		Input value		Output value	
		EN	Activation of the function block ①				
				I1	Value to be converted ②		
						QV	Converted value ③

Read the description of the inputs/outputs in the legend points in the following tables.

5.22.2 Wiring of the function block

The function block is enabled in the circuit diagram.

5.22.2.1 Coil

Coil NC..EN is used to activate the function block. If the coil NC..EN is not active, the entire function block is deactivated and reset. The output value is set to zero.

Parameters	Function
① NC..EN	Enables the function block

5.22.2.2 Example:

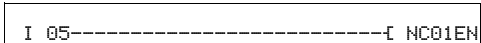

Figure 190: Wiring the enable coil

Its coil NC..EN is directly connected to the device terminal IS5.

5.22.3 Parametric programming of the function block inputs/outputs

5.22.3.1 Parameters

```

NC02 BCD      +
>I1
QU>
    
```

NC02	Function block; Numerical converter, number 02
BCD	Operating mode: Converting BCD to binary
+	Parameter display: Call enabled
② >I1	Input value: Decimal: -161061273 - +161061273 BCD: -9999999 - +9999999
③ QU>	Output value: Decimal: -161061273 - +161061273 BCD: -9999999 - +9999999

The parameter set consists of:

Operating Mode

The operating mode determines whether a binary value is to be converted to BCD or vice versa.

Parameters	Function, parameterization in the function block
BCD	Converting BCD to binary
BIN	Converting binary to BCD

The factory setting of this parameter is BCD.

Parameter Display

The display of the parameters during operation can be disabled. Additional information → section "4.9.2.1 Parameter assignment from the circuit diagram", page 191.

Parameters	Function
+	Parameters are displayed
-	Parameters are not displayed

This parameter is factory set to +.

5.22.3.2 Number range of the BCD code

The BCD code only allows the number range 0 to 9. Values greater than 9 are processed as 9.

BCD code	Decimal value
0000	0
0001	1
0010	2
0011	3

BCD code	Decimal value
0100	4
0101	5
0110	6
0111	7
1000	8
1001	9
1010 - 1111	Not permissible

Input

Assign the input value to be converted to function block input >I1.

The function block input >I1 can be assigned the following operands:

- Constant.
- Markers MD, MW, MB.
- Analog inputs IA01 to IA04:
 - IA01: Terminal I7.
 - IA02: Terminal I8.
 - IA03: Terminal I11.
 - IA04: Terminal I12.
- Analog output QA01.
- Output ...QV> of a different function block.

Output

Output QV> supplies the converted value.

You can assign the following operands to the function block output NC..QV :

- Analog output QA01.
- Markers MD, MW, MB.

Memory requirement

The numerical converter function block requires 32 bytes of memory plus 4 bytes per constant at the function block input.

Cycle time

mode	Cycle time [µs]
BCD	34
BIN	127

5.22.4 Function of the function block

5.22.4.1 BCD operating mode

The BCD value present at input I1 is converted to a binary value and supplied on the output QV>. The binary value is displayed as a decimal value.

Example 1:

- Input value >I1: +9_{dec}
- Binary value: 1001
- Decimal value QV>: + 9

Example 2:

- Input value >I1: +14_{dec}
- Binary value: 1110
- Decimal value QV>: + 9

Example 3:

- Input value >I1: 19_{dec}
- Binary value: 00010011
- Decimal value QV>: 13

Example 4:

- Input value >I1: 161061273_{dec}
- Binary value: 1001100110011001100110011001
- Decimal value QV>: 9999999

Example 5:

- Input value >I1: -61673_{dec}
- Binary value: 10000000000000001111000011101001
- Decimal value QV>: -9099



Bit 32 is the sign bit.
Bit 32 = 1 → Sign = Minus.

Example 6:

- Input value >I1: 2147483647_{dec}
- Binary value: 01111111111111111111111111111111
- Decimal value QV>: 9999999



Values greater than 161061273 are output as 9999999. Values less than -161061273 are output as -9999999. The working range of the function block has been exceeded.

BIN operating mode

The binary value present at input >I1 is converted to a BCD value and supplied at the output QV>. The binary value is displayed as a decimal value.

Example 1:

- Input value >I1: $+7_{\text{dec}}$
- BCD binary value: 0111
- Hexadecimal value: 0111
- Decimal value QV>: + 7

Example 2:

- Input value >I1: $+11_{\text{dec}}$
- BCD binary value: 00010001
- Hexadecimal value: 00010001
- Decimal value QV>: +17 (1 + 16)

Hexadecimal value:

- Bit 0 has the value 1
- Bit 4 has the value 16
- Sum: Bit 0 plus bit 4 = 17

Example 3:

- Input value >I1: 19_{dec}
- BCD binary value: 00011001
- Hexadecimal value: 00011001
- Decimal value QV>: 25 (1 + 8 + 16)

Example 4:

- Input value >I1: 9999999_{dec}
- BCD binary value: 1001100110011001100110011001
- Hexadecimal value: 1001100110011001100110011001
- Decimal value QV>: 161061273

Example 5:

- Input value >I1: -61673_{dec}
- BCD binary value: 10000000000001100001011001110011

Hexadecimal value:

- 10000000000001100001011001110011
- Decimal value QV>: -398963



Bit 32 is the sign bit. Bit 32 = 1 → Sign = Minus.

Example 6:

- Input value >I1: 2147483647_{dec}
- BCD binary value: 01111111111111111111111111111111
- Hexadecimal value: 01111111111111111111111111111111
- Decimal value QV>: 161061273



Values greater than 9999999 are output as 161061273. Values less than -9999999 are output as -161061273. The working range of the function block has been exceeded.

5 Function blocks

5.23 OT, operating hours counter

5.23 OT, operating hours counter

The function block is used to record the operating hours of independent events or states. The status of the operating hours counter is also retained when in a de-energized state. As soon as the enable coil of the function block is active, the MFD counts the hours in minutes, although the display only shows hours.

MFD device allows the use of up to 4 hours-run counters.

5.23.1 Function block inputs/outputs

Hours-run counter OT01...OT04 (Operating Time)				Parameters	
Boolean inputs/outputs					
Contact		Coil	Input value	Output value	
Q1	Setpoint reached ①				
		EN	Activation of the function block ②		
		RE	Resetting a function block ③		
			I1	Setpoint value ④	
				QV	Actual value ⑤

Read the description of the inputs/outputs in the legend points in the following tables.

5.23.2 Wiring of the function block

You wire the function block in the standard circuit diagram with its coils and contact.

5.23.2.1 Coils

The enable coil starts the function of the function block.

The reset coil resets the operating hours counter to zero.

Parameters	Function
② OT..EN	Selective activation of the function block
③ OT..RE	Reset the counter to zero

5.23.2.2 Contact

A closed contact indicates:

Parameters	Function
① JC..Q1	Reaching the upper limit setpoint

5.23.2.3 Example of an operating hours counter:

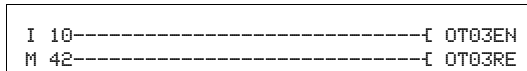

Figure 191: Wiring the function block coils

The enable coil of the function block is connected here directly to the device inputs. A marker activates the reset coil.

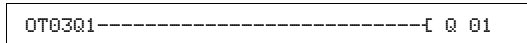

Figure 192: Wiring of the function block contact

The message of the function block was wired to a device output.

5.23.3 Parametric programming of the function block inputs/outputs

5.23.3.1 Parameters

```
OT03 +
>I1
QU>
```

When using the function block in the circuit diagram for the first time, use OK to automatically enter the general display of function block parameters, as shown in the figure on the left. Enter the function block settings here. The display contains the following elements:

OT03	Function block: Operating hours, number 03
+	Parameter display: Call enabled
④ >I1	Upper setpoint in hours: 0 hours -> 100 years
⑤ QU>	Actual value of the operating hours counter

The parameter set consists of:

Parameter Display

The display of the parameters during operation can be disabled. Further information is provided in → section "4.9.2.1 Parameter assignment from the circuit diagram", page 191.

Parameters	Function
+	Parameters are displayed
-	Parameters are not displayed

This parameter is factory set to +.

Input

The >I1 block input is used to specify the upper setpoint value in hours. When it is reached, the block contact sends a signal.

The function block input >I1 can be assigned the following operands:

- Constant.
- Markers MD, MW, MB.

5 Function blocks

5.23 OT, operating hours counter

- Analog inputs IA01 to IA04:
 - IA01: Terminal I7.
 - IA02: Terminal I8.
 - IA03: Terminal I11.
 - IA04: Terminal I12.
- Analog output QA01.
- Output ...QV> of a different function block.

Output

The output QV> supplies the counted operating hours as an integer value in hours.

You can assign the following operands to output ...QV>:

- Analog output QA01
- Markers MD, MW, MB

Memory requirement

The operating hours counter function block requires 36 bytes of memory plus 4 bytes per constant at the function block input.

Cycle time

mode	Cycle time [μ s]
-	25

5.23.4 Function of the function block

If the enable coil OT...EN is triggered to the 1 state, the counter adds the value 1 to its actual value every minute (basic clock rate: 1 minute).

If the actual value on QV> reaches the setpoint value of >I1, the contact OT...Q1 switches for as long as the actual value is greater than or equal to the setpoint value.

The actual value is retained in the unit until the reset coil OT...RE is actuated. The actual value is then set to zero.



The following operations do not clear the actual value of the hours-run counter: Operating mode change RUN, STOP, voltage ON, OFF, Delete program, Change program, Load new program.

5.23.4.1 Accuracy

The operating hours counter is accurate to the nearest minute. If the enable coil signal is terminated within a minute, the value for seconds is lost.

The value range of the operating hours counter is between 0 hours and 100 years.

5.24 PT - Put value to the NET

The PUT function block PT.. enables you to transfer a 32-bit operand to the NET. The operand value is transferred and automatically read by the corresponding GET function block GT of another NET station.

MFD device allows the use of up to 32 PUT function blocks.

5.24.1 Function block inputs/outputs

Function block PUT PT01...PT32 (PuT)			
Boolean inputs/outputs		Parameters	
Contact	Coil	Input value	Output value
T_	Trigger confirmation ①		
AC	Buffering and transfer to NET ②		
E1	Transmission error ③		
		T_	Trigger Signal ④
		I1	The setpoint that is to be transferred to the NET network ⑤

Read the description of the inputs/outputs in the legend points in the following tables.

5.24.2 Wiring of the function block

You wire the function block in the circuit diagram with its trigger coil and its contacts.

5.24.2.1 Coil

On activation the function block temporarily stores the input value and transfers it to the NET.

Parameters	Function
④ PT..T_	Trigger coil, on a rising edge the function block temporarily stores the input value and transfers it to the NET

5 Function blocks

5.24 PT - Put value to the NET

5.24.2.2 Contacts

A closed contact indicates:

	Parameters	Function
①	PT..Q1	The trigger coil is active
②	PT..AC	The temporary storage and subsequent transfer of the input value to the NET. 1).
③	PT..E1	A transfer error. 1)

1) These outputs are available from device version 05.

5.24.2.3 Example of a PUT function block:

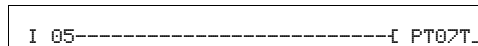

Figure 193: Wiring the trigger coil

The trigger coil is connected to a device input.

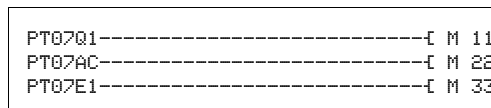
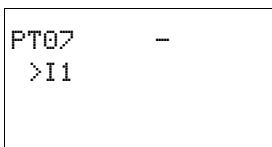

Figure 194: Wiring the function block contacts

The contacts transfer the function block information to markers.

5.24.3 Parametric programming of the function block inputs/outputs

5.24.3.1 Parameters



When using the function block in the circuit diagram for the first time, use OK to automatically enter the general display of function block parameters, as shown in the figure on the left. Enter the function block settings here. The display contains the following elements:

PT07	Function block: PUT, number 07
-	Parameter display: Call not enabled
⑤ >I1	Input value that is to be put onto the NET: -2147483648 - 2147483647

The parameter set consists of:

Parameter Display

The display of the parameters during operation can be disabled. Additional information → section “4.9.2.1 Parameter assignment from the circuit diagram”, page 191.

Parameters	Function
+	Parameters are displayed
-	Parameters are not displayed

This parameter is factory set to +.

Input

>I1: When the function block is triggered, the value present at function block input >I1 is temporarily stored and then transferred to the NET. The function block input can be assigned the following operands:

- Constant.
- Markers MD, MW, MB.
- Analog inputs IA01 to IA04:
 - IA01: Terminal I7.
 - IA02: Terminal I8.
 - IA03: Terminal I11.
 - IA04: Terminal I12.
- Analog output QA01.
- Output ...QV> of a different function block.

Memory requirement

The PUT function block requires 36 bytes of memory plus 4 bytes per constant at the function block input.

Cycle time

mode	Cycle time [μs]
-	25

5.24.3.2 PUT diagnostics

The PUT function block only functions if the NET is running properly (→ section “9.3 Diagnostics”, page 479).

5 Function blocks

5.24 PT - Put value to the NET

5.24.4 Function of the function block

When the trigger coil PT..T_ picks up, the contact PT..Q1 and stays closed for as long as the trigger coil remains activated.

The pickup triggers the buffering of the input value present at input >I1. The function block then transfers this value to the NET. During this time, the function block contact PT..Q1 closes.

If the temporarily stored value is not sent, the contact PT..E1 closes and therefore indicates a transfer error. It stays closed until the trigger coil PT..T_ picks up to issue a new send job.

The signal diagram shows the relationship of the send job and its triggering by the trigger coil:

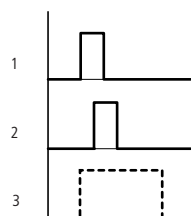

Figure 195: Signal diagram of PUT function block

- 1: Trigger coil
- 2: trigger coil contact feedback
- 3: Send

5.25 PW, pulse width modulation

The PW function block modulates the pulse duty factor of a square wave signal, and thus changes the mark to space ratio and pulse duration. The period duration of the signal is unchanged.

The function block is primarily used for outputting the manipulated variable of a PID controller. The maximum frequency is 200 Hz. This corresponds to a period duration of 5 ms. The maximum period duration is 65.5 s.



When using the pulse width modulation function block with a minimum on time of less than 1 s only use devices with transistor outputs.

2 function blocks are provided. Each function block is assigned an output for pulse width modulation: PW01 -> Q01 / PW02 -> Q02. The Q01/Q02 outputs used must not be processed elsewhere in the circuit diagram.

5.25.1 Function block inputs/outputs



A status change at Q01 or Q02 generated by the circuit diagram is suppressed in favor of the higher prioritized status change by the function block.

Pulse width modulation PW01...PW02 (Pulse Width modulation)							
Boolean inputs/outputs				Parameters			
Contact		Coil		Input value		Output value	
E1	Error output ①						
		EN	Activation the function block ②				
				SV	Manipulated variable ③		
				PD	Period duration [ms] ④		
				ME	Minimum On duration [ms] ⑤		

Read the description of the inputs/outputs in the legend points in the following tables.

5.25.2 Wiring of the function block

You wire the function block in the circuit diagram with its enable coil and its signal contact.



Avoid unforeseeable switch states. Only use each coil of a relay once in the circuit diagram.

5 Function blocks

5.25 PW, pulse width modulation

5.25.2.1 Coil

The coil PW..EN is used to activate the function block in the circuit diagram.

Parameters	Function
② PW..EN	Selective activation of the function block

5.25.2.2 Contact

A closed contact indicates:

Parameters	Function
① PW..E1	Fault message: minimum on time or minimum off time exceeded

5.25.2.3 Example:

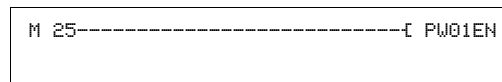

Figure 196: Wiring the enable coil

The enable coil PW..EN is directly assigned to marker M25.

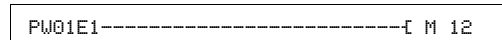
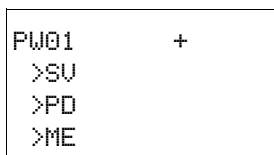

Figure 197: Wiring of the signal contact

The function block contact PW..E1 signals to marker M12.

5.25.3 Parametric programming of the function block inputs/outputs

5.25.3.1 Parameters



When using the function block in the circuit diagram for the first time, use OK to automatically enter the general display of function block parameters, as shown in the figure on the left. Enter the function block settings here. The display contains the following elements:

PW01	Function block; Data multiplexer, number 01
+	Parameter display: Call enabled
③ >SU	Manipulated variable: 0 - 4095
④ >PD	Period duration: 0 - 65535 ms
⑤ >ME	Minimum on duration, minimum off duration: 0 - 65535 ms

The parameter set consists of:

Parameter Display

The display of the parameters during operation can be disabled. Additional information → section “4.9.2.1 Parameter assignment from the circuit diagram”, page 191.

Parameters	Function
+	Parameters are displayed
-	Parameters are not displayed

This parameter is factory set to +.

Inputs

>SV: Assign the manipulated variable to function block input >SV.

>PD: Input >PD is used to define the period duration.



The minimum setting for the period duration is 5, i.e. 0.005 s (5 ms)

>ME: You set the minimum on duration, minimum off duration at input >ME.

You can assign the following operands to function block inputs >SV and >PD to >ME:

- Constant
- Markers MD, MW, MB
- Analog inputs IA01 to IA04:
 - IA01: Terminal I7
 - IA02: Terminal I8
 - IA03: Terminal I11
 - IA04: Terminal I12
- Analog output QA01
- Output ...QV> of a different function block

Memory requirement

The pulse width modulation function block requires 48 bytes of memory plus 4 bytes per constant at the function block input.

Cycle time

mode	Cycle time [µs]
-	243

5 Function blocks

5.25 PW, pulse width modulation

5.25.4 Function of the function block



The pulse width modulation function block must be enabled so that it can work. Coil PW...EN must be active. If coil PW...EN is not active, the entire function block is deactivated and reset. The output value is set to zero.

The manipulated variable at function block input >SV is converted to a pulse string with a constant period duration. The pulse width is proportional to the manipulated variable >SV. The period duration and the minimum on duration can be selected as required within the specified limits.

The function block causes a direct output of the pulse to the corresponding device output (Q1 and Q2). The output image of the circuit diagram is always updated.



The following applies if the output of a pulse width modulator is used as a coil in the circuit diagram:
The state of the output is not refreshed from the circuit diagram.



The following applies to the minimum on duration:

- The minimum on duration is equal to the minimum off duration.
- The minimum on duration must not exceed 10 % of the period duration. The ratio of period duration/minimum on duration (P/M) determines which percentage of the manipulated variable has no effect. The minimum on duration must be set as low as possible so that the P/M ratio is as high as possible. If the minimum on duration must not be too low, due to the output relay, the period duration must be increased accordingly.
- The minimum on duration is 1 ms.
- If the actual value of the pulse length is less than the minimum on duration, the minimum on duration has the effect of the pulse time. The status of the PW..E1 contact must be observed.
- If the off duration of the pulse is less than the minimum off duration, outputs Q1 and Q2 are continuously in operation. The status of the PW..E1 contact must be observed.

5.26 SC, set date/time

This function block allows you to selectively place the date and time onto the network. All other stations accept the date and time of the sending station.

MFD device allows the use of one "set date/time function block".

5.26.1 Function block inputs/outputs

Set date/time SC01 (Set Clock)			
Boolean inputs/outputs		Parameters	
Contact	Coil	Input value	Output value
Q1	Trigger confirmation ①		
	T_	Trigger Signal ②	

Read the description of the inputs/outputs in the legend points in the following tables.

5.26.2 Wiring of the function block

You wire the function block in the circuit diagram with its trigger coil and its contact.

5.26.2.1 Coil

Parameters	Function
② SC01T_	Trigger coil, on rising edge the function block transfers date and time of the sending station to the NET

5.26.2.2 Contact

A closed contact indicates:

Parameters	Function
① SC01Q1	The trigger coil is active

5.26.2.3 Example of a set date/time function block:

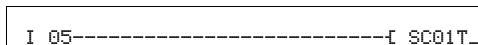

Figure 198: Wiring the trigger coil

The trigger coil is connected to a device input.

5 Function blocks

5.26 SC, set date/time

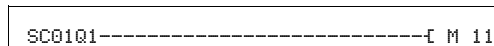

Figure 199: Wiring of the function block contact

The contact is assigned to a marker.

5.26.3 Parametric programming of the function block inputs/outputs

Parameters

This function block is a triggerable system service. It therefore does not have any parameters.

Memory requirement

The SC function block requires 20 bytes of memory.

Cycle time

mode	Cycle time [μ s]
-	23

5.26.3.1 SC diagnostics

The SC function block only functions if the easyNet network is running properly (→ section “9.3 Diagnostics”, page 479).

5.26.4 Function of the function block

If the trigger coil of the function block is activated, the current date, the day of the week and time from the sending station is automatically put onto the easyNet network. The sending stations executes this operation as soon as a new minute starts on the device real-time clock. The other stations accept this value.

Example

The trigger pulse is set at 03:32:21 (hh:mm:ss). The other stations are synchronized at 03:33:00. The time is accepted by all stations. This process can be repeated as often as desired.

5.26.4.1 Accuracy of time synchronization

The maximum time deviation between the functional stations is 5 s.

5.27 SR, shift register

The shift register function block enables you to move bits or marker double words one position forwards or backwards with every clock pulse, depending on whether Bit or Double word (DW) operating mode is selected. The shift register has a linear structure. If, for example, a bit is added at one end of the shift register in a bit operation with a clock pulse, a bit will be pushed out at the other end. You can choose between two operating modes:

- Bit (BIT).
- Double word (DW).

MFD device allows the use of up to 32 shift registers.

5.27.1 Function block inputs/outputs

Shift register SR01...SR32 (Shift Register)							
Boolean inputs/outputs				Parameters			
Contact		Coil		Input value		Output value	
Q1 ... Q8	Bit outputs ①						
		EN	Activation of the function block ②				
		FP	Clock input, shift register forward ③				
		BP	Clock input, shift register backward ④				
		RE	Reset ⑤				
		FD	Bit data input, shift register forward ⑥				
		BD	Bit data input, shift register backward ⑦				
				I1	Input value for shift direction forwards ⑧		
				I2	Input value for shift direction backwards ⑨		
						D1 ... D8	Register values 1...8 ⑩

Read the description of the inputs/outputs in the legend points in the following tables.

5.27.2 Wiring of the function block

In BIT operating mode you integrate the shift register function block in the standard circuit diagram with its coils and contacts.

5.27.2.1 Coils

The coil SR..EN is used to activate the function block in the circuit diagram.

Parameters	Function
② SR..EN	Selective activation of the function block

The forwards pulse input coil SR..FP triggers the following function when it is activated, depending on the operating mode:

Parameters	Function
③ SR..FP	Pulse input forwards BIT mode: Transfer of the data bit at the input coil SR..FD into the register SR..Q1. DW operating mode: Transfer of the value SR..I1 to the register SR..D1.

The remaining content of the register is then moved forwards.

The backwards pulse input coil SR..BP triggers the following function when it is activated, depending on the operating mode:

Parameters	Function
④ SR..BP	Pulse input backwards BIT mode: Transfer of the data bit at the input coil SR..BD into the register SR..Q8. DW operating mode: Transfer of the value SR..I2 to the register SR..D8.

The remaining content of the register is then moved backwards.

The reset coil SR..RE causes the following in both directions:

Parameters	Function
⑤ SR..RE	Reset of the register

Parameters	Function
⑥ SR..FD	Data bit forwards

Parameters	Function
⑦ SR..BD	data bit backwards

5.27.2.2 Contacts

The function block in BIT mode has 8 contacts SR..Q1 to SR..Q8 for the circuit diagram.

Coil	Function
① SR..Q1 - SR..Q8	Output of the bit register fields 1 - 8

5.27.2.3 Examples

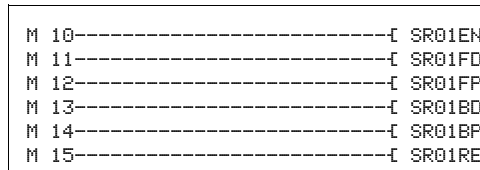

Figure 200: BIT operating mode, wiring the function block coils

The function block coils are switched by markers.

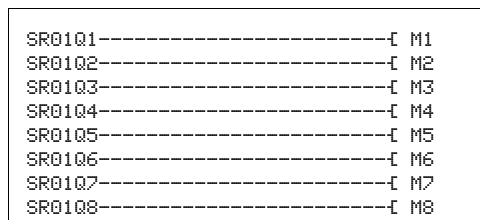

Figure 201: BIT operating mode, wiring the function block contacts

The contacts of the function block are connected with markers.

In DW operating mode you only integrate the coils in the circuit diagram:

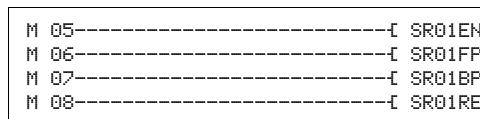

Figure 202: DW operating mode, wiring the function block contacts

You assign parameters to inputs and outputs in the function block diagram.

5.27.3 Parametric programming of the function block inputs/outputs

5.27.3.1 Parameters

When using the function block in the circuit diagram for the first time, use OK to automatically enter the general display of function block parameters, as shown in the figure on the left. Enter the function block settings here.

The parameter display is the same for both operating modes and only the parameter for data format is different.

Operating Mode

With this parameter you define whether you wish to run the shift register as a bit register or in double word format.

Parameters	Function, parameterization in the function block
BIT	Bit operation
DW	Double word operation

The factory setting of this parameter is BIT.

```
SR01 BIT +
>I1
>I2
D1>
D2>
D3>
D4>
D5>
D6>
D7>
D8>
```

- BIT operating mode
 The function block must be included in the program. Once selected, the parameter block appears, as shown on the left. In this operating mode, the data bit is transferred to the SR..FS input coil to be shifted forward and to SR..BD to be shifted backward.



The displayed inputs/outputs of the function block I1, I2 and D1-D8 have no function in BIT mode! If they are assigned operands, these will have no effect. The wiring of the SR function block (BIT) is carried out in the circuit diagram.

```
SR01 DW +
>I1
>I2
D1>
D2>
D3>
D4>
D5>
D6>
D7>
D8>
```

- DW operating mode

SR01	Function block: SR shift register, number 01
DW	Operating mode: Double word marker operation
+	Appears in the parameter display
⑧ >I1	Input value forwards: -2147483648 - 2147483647
⑨ >I2	Input value backwards: -2147483648 - 2147483647
⑩ D1>	Register value 1 of the shift register, Value range of all registers: -2147483648 - +2147483647
D2>	Register value 2
D3>	Register value 3
D4>	Register value 4
D5>	Register value 5
D6>	Register value 6
D7>	Register value 7
D8>	Register value 8

The parameter set consists of:

Parameter Display

The display of the parameters during operation can be disabled. Further information on this is provided → Section "4.9.2.1 Parameter assignment from the circuit diagram" on page 191.

Parameters	Function
+	Parameters are displayed
-	Parameters are not displayed

This parameter is factory set to +.

Inputs

>I1 und >I2: In DW operating mode you assign function block inputs >I1 and >I2 with the values that are to be read into the shift register. You can assign the following operands to function block inputs:

- Constant.
- Markers MD, MW, MB.
- Analog inputs IA01 to IA04:
 - IA01: Terminal I7.
 - IA02: Terminal I8.
 - IA03: Terminal I11.
 - IA04: Terminal I12.
- Analog output QA01.
- Output ...QV> of a different function block.

Outputs

D1> to D8>: Likewise, only in DW operating mode do the function block outputs D1> to D8> output register values 1 to 8. The outputs can have the following operands:

- Analog output QA01.
- Markers MD, MW, MB.

Memory requirement

The SR function block requires 96 bytes of memory plus 4 bytes per constant at the function block input.

5.27.4 Function of the function block



The shift register function block must be enabled so that it can work, i.e. the coil SR..EN must be active. If this is not active, the entire function block is deactivated.

The shift register has a linear structure. This means that a clock pulse initiates the following actions:

- A new value/data bit is transferred to the register and the other data is moved one place further in the register.
- The value/data bit at the other end of the register is pushed out.
- Both shift directions, forwards and backwards, are possible.

The function block has two operating modes for different data formats:

- BIT for a bit data format
- DW for a double word data format.

In BIT operating mode, the function block uses

- Input coils: SR..FD and SR..BD.
- Register field contacts: SR..Q1 to SR..Q8.

In DW operating mode the function block processes inputs and outputs in double word format:

- Inputs SR..I1 and SR..I2
- Outputs: SR..D1 to SR..D8.

SR..FD and SR..I1 are for data that the function block transfers to register Q1 or D1 in a forwards direction when SR..FP is activated.

The following two figures illustrate the process for forward shift operations in BIT and DW modes.

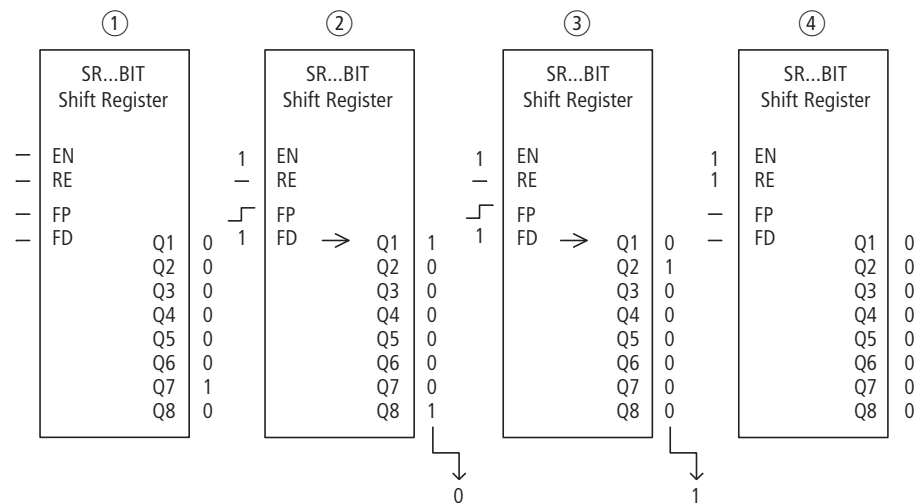

Figure 203: Shift register SR..: Forwards operation in BIT operating mode

- ① Initial situation
 - SR..EN is not activated, the function block is not active.
 - SR..Q7 contains a data bit 1, a 0 is contained in the other register fields.
- ② Transfer of a data bit:
 - SR..EN is activated, the function block is active.
 - SR..FD has data bit 1.
 - With the forwards pulse from SR..FP the register field SR..Q1 shifts the content of all register fields one place forwards and accepts the 1 from SR..FD.
- ③ Transfer of a data bit:
 - SR..EN is activated, the function block is active.
 - SR..FD has data bit 0.
 - with the forwards pulse from SR..FP the register field SR..Q1 shifts the content of all register fields one place forwards and accepts the 0 from SR..FD.
- ④ Reset of the register:
 - SR..EN is activated, the function block is active.
 - Activating SR..RE clears the content of the register.

5 Function blocks

5.27 SR, shift register

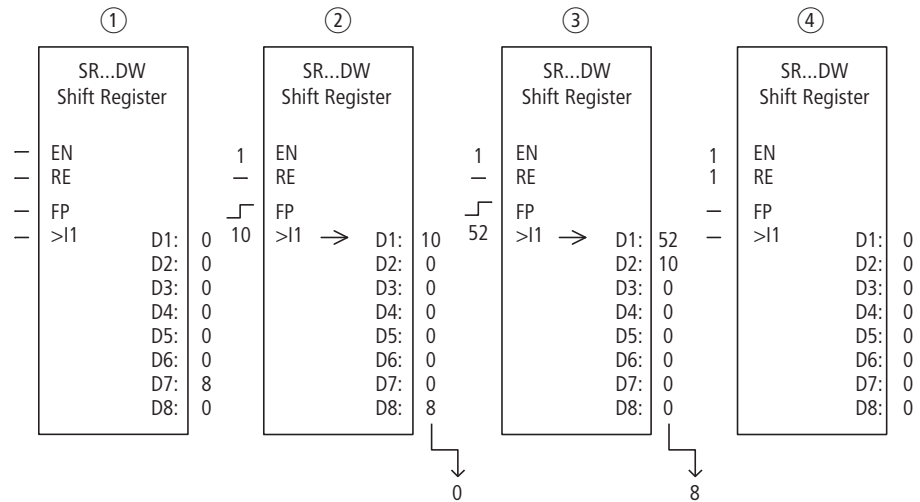

Figure 204: Shift register SR..: Forwards operation in DW mode

- ① Initial situation:
 - SR..EN is not activated, the function block is not active.
 - SR..D7 contains the value 8, a 0 is contained in the other register fields.
- ② Transfer of value:
 - SR..EN is activated, the function block is active.
 - SR..I1 has the value 10.
 - With the forwards pulse from SR..FP the register field SR..D1 shifts the content of all register fields one place forwards and accepts the 10 from SR..I1.
- ③ Transfer of value:
 - SR..EN is activated, the function block is active.
 - SR..I1 has the value 52.
 - with the forwards pulse from SR..FP the register field SR..D1 shifts the content of all register fields one place forwards and accepts the 52 from SR..I1.
- ④ Reset of the register:
 - SR..EN is activated, the function block is active.
 - Activating SR..RE clears the content of the register.

SR..BD and SR..I2 are for data that the function block transfers to register Q8 or D8 in a backwards direction when SR..BP is activated, → Figure 205 and 206.

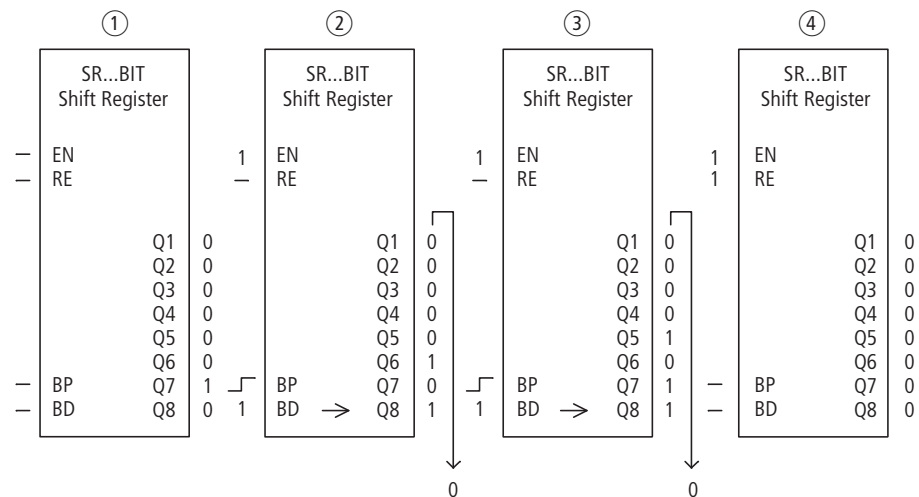

Figure 205: Shift register SR..: Backwards operation in BIT operating mode

- ① Initial situation:
 - SR..EN is not activated, the function block is not active.
 - SR..Q7 contains a data bit 1, a 0 is contained in the other register fields.
- ② Transfer of a data bit:
 - SR..EN is activated, the function block is active.
 - SR..BD has data bit 1.
 - With the backwards pulse from SR..BP the register field SR..Q8 shifts the content of all register fields one place back and accepts the 1 from SR..BD.
- ③ Transfer of a data bit:
 - SR..EN is activated, the function block is active.
 - SR..BD has data bit 0.
 - With the backwards pulse from SR..BP the register field SR..Q8 shifts the content of all register fields one place back and accepts the 0 from SR..BD.
- ④ Reset of the register:
 - SR..EN is activated, the function block is active.
 - Activating SR..RE clears the content of the register.

5 Function blocks

5.27 SR, shift register

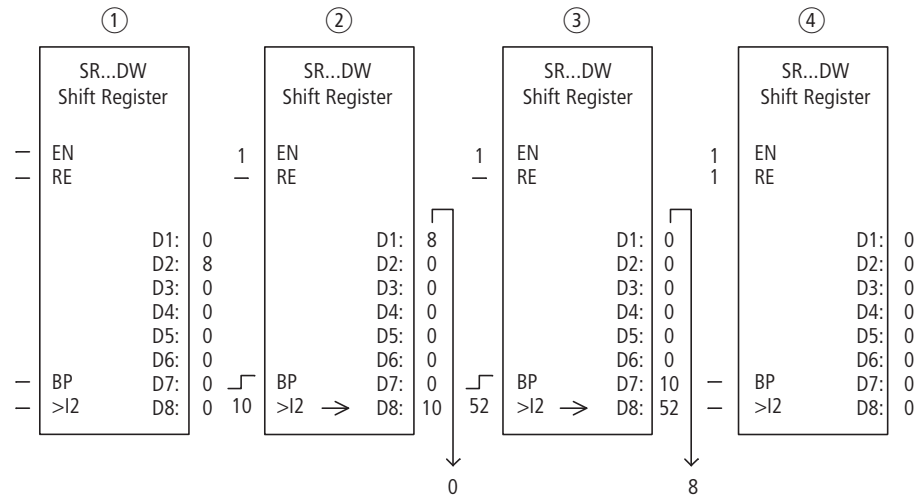

Figure 206: Shift register SR..: Backwards operation in DW operating mode

- ① Initial situation:
 - SR..EN is not activated, the function block is not active.
 - SR..D2 contains the value 8, a 0 is contained in the other register fields.
- ② Transfer of value:
 - SR..EN is activated, the function block is active.
 - SR..I2 has the value 10.
 - With the backwards pulse from SR..BP the register field SR..D8 shifts the content of all register fields one place back and accepts the 10 from SR..I2.
- ③ Transfer of value:
 - SR..EN is activated, the function block is active.
 - SR..I2 has the value 52.
 - With the backwards pulse from SR..BP the register field SR..D8 shifts the content of all register fields one place back and accepts the 52 from SR..I2.
- ④ Reset of the register:
 - SR..EN is activated, the function block is active.
 - Activating SR..RE clears the content of the register.

5.27.4.1 Example 1

A sequence of operating steps is controlled using a bit shift register.

The individual operating steps are permanently assigned to a register field. A step is initiated when its register contact is switched. As soon as it is completed, SR..FP is activated and the subsequent register contact starts the next step. The first operating step is carried out if the 1 at the register input is transferred to the register when SR.FP is activated and is indicated at SR..Q1.

```
SR12 BIT  +
>I1
>I2
D1>
```

The figure on the left shows the parameter display and the parameter set for the function block SR12. Once shift register number 12 has been defined, you set here only BIT operating mode for the bit format.

The coils are programmed in the circuit diagram of MFD:

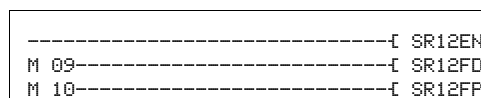

Figure 207: MFD circuit diagram for example 1

- The enable coil SR12EN is permanently active, the function block is not switched off.
- Marker M09 transfers the 1 to SR12FD for the first step.
- Marker M10 switches the forwards pulse input coil SR12FP.

5.27.4.2 Example 2

Different workpieces are moved along a production line with several machining stations. An operator determines the work required for the individual workpieces, creates a production code for it and writes it into a shift register.

The workpieces reach the machining stations in this order. When the workpiece is changed, the stations read the required production steps from their permanently assigned register field.

When workpiece 1 moves to the first station, the forwards pulse input coil SR01FP and the shift register SR01 receive production code 1 at input SR01I1 from the double word marker MD11.

Production code 1 is now at the register field SR01D1 for the first machining station which reads it from double word marker MD01.

The finished workpiece is then transferred to station 2.

The shift register accepts the production code 2 for the next workpiece. Production code 1 moves one place forwards, as does the remaining register content. It now stands at register output SR01D2. It reaches machining station 2 via double word marker MD02.

The process is repeated for each further workpiece and for each further machining station until the finished workpieces leave the line.

5 Function blocks

5.27 SR, shift register

The coils are programmed in the circuit diagram of MFD:

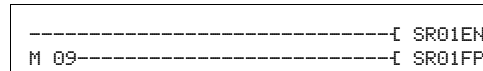

Figure 208: MFD circuit diagram for example 2

- The enable coil SR01EN is permanently active, the function block is not switched off.
- Marker M09 switches the forwards pulse input coil SR01FP.

The figure on the left shows the parameter display and the parameter set. After defining shift register number 01, you set here the following parameters:

```

SR01 DW      +
  >I1 MD11
>I2
D1> MD01
D2> MD02
D3> MD03
D4>
D5>
D6>
D7>
D8>
  
```

- the DW operating mode for the double word marker format.
- the double word markers for receiving the production code.

5.28 ST, Set cycle time

The Set cycle time function block is used as an additional function block for the PID controller and the counter function blocks. It provides a fixed cycle time for processing the circuit diagram and the function blocks. When used with a PID controller it improves the control response. It can also be used to suppress the sporadic lengthening of the cycle time when changing screens in the MFD. One function block is provided.

5.28.1 Function block inputs/outputs

Cycle time ST1 (Set Time)			
Boolean inputs/outputs		Parameters	
Contact	Coil	Input value	Output value
	EN	I1	
	Activation of the function block	Required Cycle Time in ms ②	

Read the description of the inputs/outputs in the legend points in the following tables.

5.28.2 Wiring of the function block

You wire the function block in the circuit diagram with an enable coil.

5.28.2.1 Coil

Parameters	Function
① ST01EN	Selective activation of the function block

5.28.2.2 Example of a function block for setting the set cycle time:

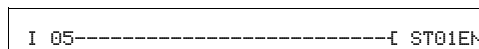
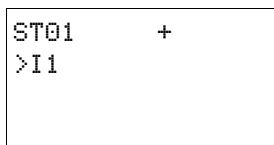

Figure 209: Wiring the enable coil

5.28.3 Parametric programming of the function block inputs/outputs

5.28.3.1 Parameters



When using the function block in the circuit diagram for the first time, use OK to automatically enter the general display of function block parameters, as shown in the figure on the left. Enter the function block settings here. The display contains the following elements:

5 Function blocks

5.28 ST, Set cycle time

ST01	Function block: Set cycle time, number 11
+	Parameter display: Call enabled
② >I1	Set cycle time: 0 - 1000 ms

The parameter set consists of:

Parameter Display

The display of the parameters during operation can be disabled. Additional information → section "4.9.2.1 Parameter assignment from the circuit diagram", page 191.

Parameters	Function
+	Parameters are displayed
-	Parameters are not displayed

This parameter is factory set to +.

Input

>I1: The set cycle time is entered at function block input >I1.

The function block input >I1 can be assigned the following operands:

- Constant.
- Markers MD, MW, MB.
- Analog inputs IA01 to IA04:
 - IA01: Terminal I7.
 - IA02: Terminal I8.
 - IA03: Terminal I11.
 - IA04: Terminal I12.
- Analog output QA01.
- Output ...QV> of a different function block.

Memory requirement

The Set cycle time function block requires 24 bytes of memory plus 4 bytes per constant at the function block input.

5.28.4 Function of the function block

The function block is used to define a fixed cycle time.



The function block must be enabled so that it can work. Coil ST01EN is active. If coil ST01EN is not active, the entire function block is deactivated and reset.

Cycle time less than set cycle time:

If the maximum cycle time present is less than the set cycle time, the set cycle time is constant.

Actual cycle time greater than set cycle time:

If the cycle time present is greater than the set cycle time, the set cycle time has no effect.

CAUTION

The shorter the cycle time, the faster the control and regulation process.

Set as small a value for the set cycle time as possible. The processing of the function blocks, reading of the inputs and writing of outputs is only carried out once every cycle.

Exception: All function blocks that are processed independently of the cycle time.

5.29 T, timing relay

With this timing relay you change the switch time and the on and off time of a switch contact. The adjustable delay times are between 50 ms and 99 h 59 min.

An MFD device allows the use of up to 32 timing relays.



page 358 on „Example with timing relay and counter function block“ provides information on the timing relay and counter function block.

5.29.1 Function block inputs/outputs

Timing Relay T01...T32 (Timer)							
Boolean inputs/outputs				Parameters			
Contact		Coil		Input value		Output value	
Q1	Switching contact ①						
		EN	Activation the function block ②				
		RE	Set actual value (QV) to 0 ③				
		ST	Stop of the timing relay ④				
				I1	Time setpoint 1 ⑤		
				I2	Time setpoint 2 ⑥		
						QV	Elapsed Time ⑦

Read the description of the inputs/outputs in the legend points in the following tables.

5.29.2 Wiring of the function block

You wire the function block in the circuit diagram with its coils and contact.

5.29.2.1 Coils

The trigger coil starts the timing relay in the circuit diagram, the Reset coil resets the run down of the timing relay to zero and the Stop coil interrupts the run down.

Parameters	Function
② T ..EN	Triggering (start) of the timing relay
③ T ..RE	Reset of the timing relay
④ T ..ST	Stop of the timing relay

5.29.2.2 Contact

A closed contact indicates:

Parameters	Function
① T ..Q1	Time function active

5.29.2.3 Timing relay example:

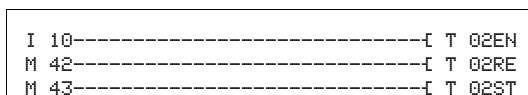

Figure 210: Wiring the function block coils

The trigger coil of the function block is connected here directly to the device inputs. A marker activates the reset coil, another marker activates the stop coil.

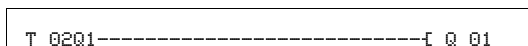

Figure 211: Wiring of the function block contact

The function block indication signal is assigned directly to a device output.

5.29.3 Parametric programming of the function block inputs/outputs

5.29.3.1 Parameters

```

T 02 X M:S +
>I1
>I2
QU>
  
```

When using the function block in the circuit diagram for the first time, use OK to automatically enter the general display of function block parameters, as shown in the figure on the left. Enter the function block settings here. The display contains the following elements:

T 02	Function block: Timing relay, number 02
X	Operating mode: On-delayed
m:s	Time range: Minute: Seconds
+	Parameter display: Call enabled
⑤ >I1	Setpoint 1
⑥ >I2	Setpoint 2 (for relay functions with 2 times)
⑦ QU>	Display: Elapsed time

The parameter set consists of:

Operating Mode

This parameter defines the switch function of the timing relay:

Parameters	Switch function
X	On-delayed switching
?X	On-delayed switching with random time range
■	Off-delayed switching
?■	Off-delayed switching with random time range
X■	On- and off-delayed
□	Off-delayed with random time range, setpoint retriggerable
?□	Off-delayed with random time range, retriggerable
?X■	On- and off-delayed switching with random time, 2 time setpoints
Π	Single pulse switching
⋈	Flashing, synchronous, 2 setpoints
⋈	Flashing, asynchronous, 2 setpoints

Time Range

The function block parameter determines in which time range and at which resolution the relay operates.

Parameters	Time range and setpoint	Resolution
S 000.00	Seconds; 0.05 to 999.995 s for constants and variable values	5 ms
M:S 00:00	Minutes:Seconds; 00:00 to 99:59 only for constants and variable values	1 s
H:M 00:00	Hours:Minutes; 00:00 to 99:59 only for constants and variable values	1 min.



Minimum time setting: 0.005 s (5 ms)
If a setpoint value is less than the MFD cycle time, the elapsed time will only be recognized in the next cycle.

Parameter Display

The display of the parameters during operation can be disabled. Additional information → section "4.9.2.1 Parameter assignment from the circuit diagram", page 191.

Parameters	Function
+	Parameters are displayed
-	Parameters are not displayed

This parameter is factory set to +.

Inputs

>I1 and >I2: You assign a time value at >I1 and >I2, depending on the switch function of the relay.

You can assign the following operands to function block inputs >I1 and >I2:

- Constant.
- Markers MD, MW, MB.
- Analog inputs IA01 to IA04:
 - IA01: Terminal I7.
 - IA02: Terminal I8.
 - IA03: Terminal I11.
 - IA04: Terminal I12.
- Analog output QA01.
- Output ...QV> of a different function block.

Output

QV>: Output QV> supplies the currently elapsed time. You can assign the following operands:

- Analog output QA01.
- Markers MD, MW, MB.

Memory requirement

The timing relay function block requires 52 bytes of memory plus 4 bytes per function block input configured with an NU constant.

Cycle time

mode	Cycle time [μ s]
All	60

5.29.3.2 Retention

Timing relays can be run with retentive actual values. The number of retentive timing relays can be selected in the SYSTEM → RETENTION menu.

If a timing relay is retentive, the actual value is retained when the operating mode is changed from RUN to STOP and when the power supply is switched off.

If MFD is started in RUN operating mode, the timing relay operates with the retentively saved actual value. The state of the trigger pulse must correspond to the function of the timing relay.

- Status 1 with:
 - On-delayed.
 - Single pulse.
 - Flashing.
- Status 0 with:
 - Off-delayed.

5.29.4 Function of the function block

The relay is started via the trigger coil T...EN and can be selectively reset via the reset coil T...RE. The third coil T..ST terminates the run down of the actual time.

Variable time values

If you associate the function block inputs T ..I1 and T ..I2 with operands, you can use variable setpoints. The setpoints are transferred as follows, depending on the time range selected:

- S, value in milliseconds. The last digit is rounded up or down to 0 or 5, maximum value = 999995 ms.
- M:S, value in seconds, maximum value = 5999 s.
- H:M, value in minutes, maximum value = 5999 min.



The delay times are the same as described for the constants.

- Examples of time range S:
 - Operand value 9504 -> Time value is 9.50 s.
 - Operand value 45507 -> is 45.51 s.
- Examples of time range M:S:
 - Operand value 5999 -> Time value is 99 h, 59 min.
- Example of time range H:M:
 - Operand value 5999 -> Time value is 99 h, 59 min.

Different methods are used depending on the operating modes of the function block:

Timing relay, on-delayed with and without random switching

Random switching:

The contact of the timing relay switches randomly within the setpoint value range.

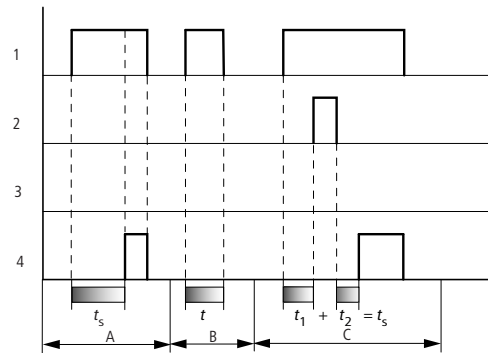

Figure 212: Signal diagram of timing relay, on-delayed (with and without random switching)

- 1: Trigger coil T...EN
- 2: Stop coil T...ST
- 3: Reset coil T...RE
- 4: Switching contact (N/O contact) T...Q1

t_s : setpoint time

- Range A: The time runs down from the set time value.
- Range B: The time does not elapse because the trigger coil drops out prematurely.
- Range C: The Stop coil stops the time from elapsing.

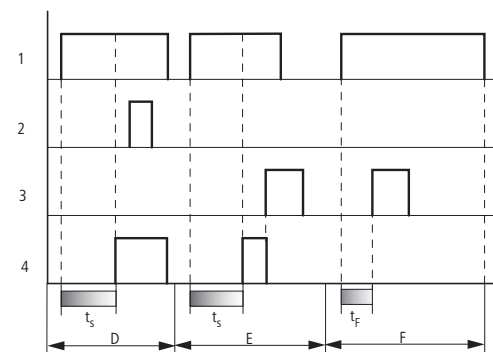

Figure 213: Signal diagram of timing relay, on-delayed (with and without random switching)

- Range D: The stop coil is inoperative after the time has elapsed.
- Range E: The reset coil resets the relay and the contact.
- Range F: After the reset coil is activated, the switching contact is switched off and the internal time counter is reset. The function relay waits for a new trigger pulse.

Timing relay, off-delayed with and without random switching

Random switching, with and without retriggering

The contact of the timing relay switches randomly within the setpoint value range.

Retriggering

When the time is running and the trigger coil is reactivated or deactivated, the actual value is reset to zero. The set time of the timing relay is timed out once more.

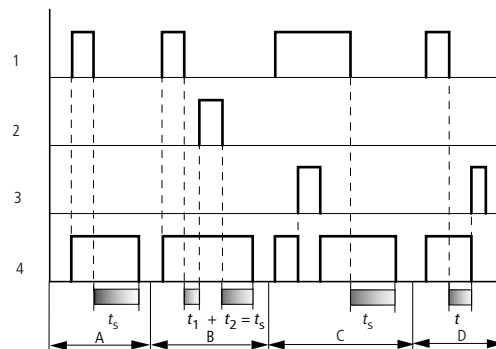

Figure 214: Signal diagram of timing relay, off delayed (with/without random switching, with/without retriggering)

- 1: Trigger coil T...EN
- 2: Stop coil T...ST
- 3: Reset coil T...RE
- 4: Switching contact (N/O contact) T...Q1

t_s : Setpoint time.

- Range A: The time elapses after the trigger coil is deactivated.
- Range B: The Stop coil stops the time from elapsing.
- Range C: The reset coil resets the relay and the contact. After the reset coil drops out, the relay continues to work normally.
- Range D: The Reset coil resets the relay and the contact when the function block is timing out.

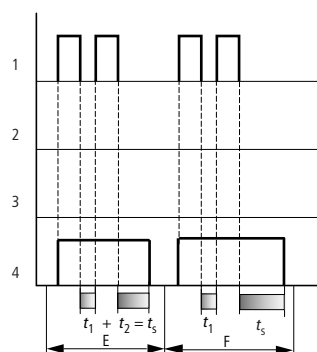

Figure 215: Signal diagram of timing relay, off delayed (with/without random switching, with/without retriggering)

- Range E: The trigger coil drops out twice. The set time t_s consists of t_1 plus t_2 (switch function not retriggerable).
- Range F: The trigger coil drops out twice. The actual time t_1 is cleared and the set time t_s elapses completely (retriggerable switch function).

Timing relay, on- and off-delayed with and without random switching

Time value >I1: On delay time
Time value >I2: Off delay time

Random switching

The contact of the timing relay switches randomly within the setpoint value ranges.

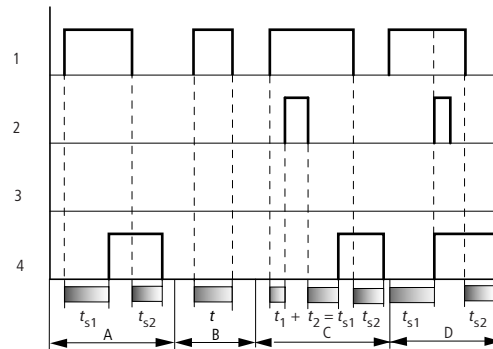

Figure 216: Operational diagrams timing relay, on and off delayed 1

- 1: Trigger coil T...EN
- 2: Stop coil T...ST
- 3: Reset coil T...RE
- 4: Switching contact (N/O contact) T...Q1

t_{s1} : pick-up time

t_{s2} : reset time

- Range A: The relay processes the two times without any interruption.
- Range B: The trigger coil drops out before the on-delay is reached.
- Range C: The stop coil stops the timeout of the on-delay.
- Range D: The stop coil has no effect in this range.

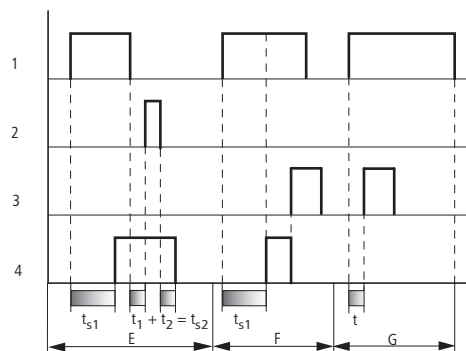

Figure 217: Operational diagrams timing relay, on and off delayed 2

- Range E: The stop coil stops the timeout of the off-delay.
- Range F: The reset coil resets the relay after the on delay has elapsed
- Range G: After the reset coil is activated, the internal time counter is reset. The switching contact remains switched off. The function relay waits for a new trigger pulse.

5 Function blocks
5.29 T, timing relay

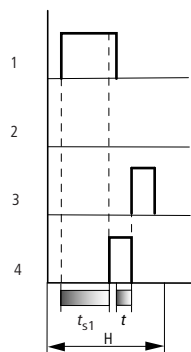

Figure 218: Operational diagrams timing relay, on and off delayed 3

- Range H: The Reset signal interrupts the timing out of the set time.

Timing relay, single pulse

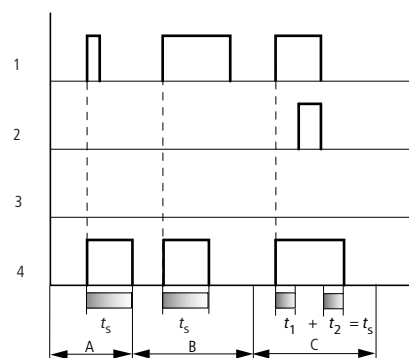

Figure 219: Signal diagram timing relay, single pulse 1

- 1: Trigger coil T...EN
 - 2: Stop coil T...ST
 - 3: Reset coil T...RE
 - 4: Switching contact (N/O contact) T...Q1
- Range A: The trigger signal is short and is lengthened.
 - Range B: The trigger signal is longer than the set time.
 - Range C: The stop coil interrupts the timing out of the set time.

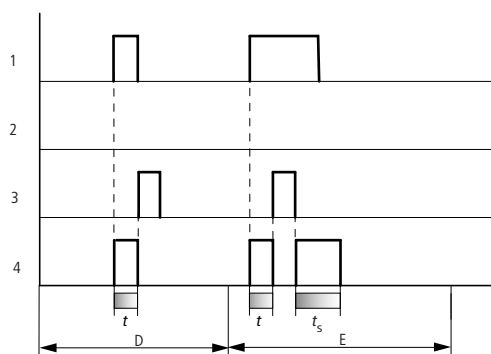

Figure 220: Operational diagram timing relay, pulse shaping 2

- Range D: The reset coil resets the timing relay.
- Range E: The reset coil resets the timing relay. The trigger coil is still energized after the reset coil is disconnected, whilst the delay time runs down.

Timing relay, synchronous and asynchronous flashing

Time value >I1: Mark time

Time value >I2: Space time

Synchronous (symmetrical) flashing: >I1 equal >I2

Asynchronous flashing: >I1 not equal >I2

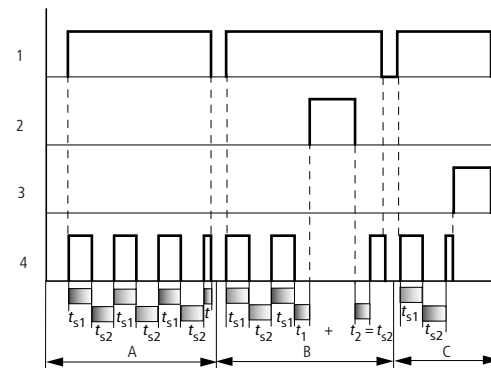

Figure 221: Signal diagram: timing relay, synchronous and asynchronous flashing

1: Trigger coil T...EN

2: Stop coil T...ST

3: Reset coil T...RE

4: Switching contact (N/O contact) T...Q1

- Range A: The relay flashes for as long as the trigger coil is activated.
- Range B: The stop coil interrupts the timing out of the set time.
- Range C: The reset coil resets the relay.

5.30 TB, table function

This function block is available from device version 05.

The table function block enables you to create and read table entries in the form of double words (32-bit). The function block operates on the principle of a stack memory which you can set for reading as either a FIFO or LIFO function (FIFO = First In First Out, LIFO = Last In First Out). A table can contain up to 16 double words.

MFD device allows the use of up to 32 table function blocks.

5.30.1 Function block inputs/outputs

Table function TB01...TB32 (Table function)							
Boolean inputs/outputs				Parameters			
Contact		Coil		Input value		Output value	
Space units	Table empty ①						
TF	Table full ②						
		EN	Activation of the function block ③				
		WP	Transfer value at I1 to the table and output at QV ④				
		RF	Oldest value output from table at QV ④				
		RL	Newest value output from table at QV ④				
		RE	Empty table ⑦				
				I1	Input value ⑧		
						QV	Table output value ⑪
						QN	Number of existing table entries ⑫

Read the description of the inputs/outputs in the legend points in the following tables.

5.30.2 Wiring of the function block

You use the table function block in the circuit diagram with its coils and contacts.

5.30.2.1 Coils

Use function block coil TB..EN to activate the function block.

With a rising edge at coil TB..WP the input value is read in the table.

The data at function block output QV> depends on which coil was activated:

- TB..WP: the actual input value read.
- TB..RF: the first table entry.
- TB..RL: the last table entry.

The reset coil TB..RE is used to fully delete the table.

Parameters	Function
③ TB..EN	Selective activation of the function block
④ TB..WP	Reads the value at input TB..I1, transfers it to the table and outputs at output QV.
⑤ TB..RF	Clears the value entered first from the table and outputs it at output QV.
⑥ TB..RL	Clears the most recently entered value from the table and outputs it at output QV.
⑦ TB..RE	Clears the table content.

5.30.2.2 Contacts

A closed contact indicates:

Parameters	Function
① TB..TE	Table is empty
② TB..TF	Table is full

5.30.2.3 Example of a table function block:

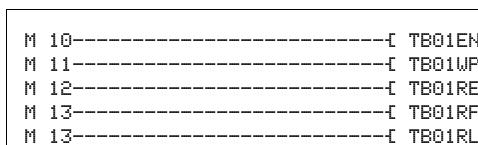

Figure 222: Wiring the function block coils

Markers switch the coils of the function block.

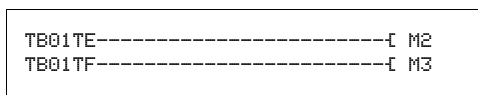

Figure 223: Wiring the function block contacts

The function block contact TE (empty) and TF (full) indicate an empty or full table.

Operands are assigned to inputs and outputs in the parameter display.

5.30.3 Parametric programming of the function block inputs/outputs

5.30.3.1 Parameters

```
TB01      +
>I1
  QV>
  QN>
```

When using the function block in the circuit diagram for the first time, use OK to automatically enter the general display of function block parameters, as shown in the figure on the left. This is where you make the function block settings, in this case, the allocation of the inputs and outputs to the operands. The display contains the following elements:

TB01	Function block: Table function, number 01
+	Parameter display: Call enabled
⑧ >I1	Table input value: -2147483648 - 2147483647
⑨ QV>	Actual, first or last table entry as output value: - 2147483648 - 2147483647
⑩ >QN	Current number of table entries: 0-16

The parameter set consists of:

Parameter Display

The display of the parameters during operation can be disabled. Additional information → section "4.9.2.1 Parameter assignment from the circuit diagram", page 191.

Parameters	Function
+	Parameters are displayed
-	Parameters are not displayed

This parameter is factory set to +.

Input

>I1: The value at input >I1 is read into the table when function block coil TB..WP is activated. The function block input >I1 can be assigned the following operands:

- Constant.
- Markers MD, MW, MB.
- Analog inputs IA01 to IA04:
 - IA01: Terminal I7.
 - IA02: Terminal I8.
 - IA03: Terminal I11.
 - IA04: Terminal I12.
- Analog output QA01.
- Output ...QV> of a different function block.

Outputs

>QV: The first and last table entry is output at output >QV, depending on the function block coils TB..RF and TB..RL.

>QN: The output >QN indicates the current number of table entries.

You can assign the following operands to the function block outputs TB..QV> and TB..QN>:

- Analog output QA01.
- Markers MD, MW, MB.

Memory requirement

The function block requires 112 bytes of memory plus 4 bytes per constant at the input.

5.30.4 Function of the function block



For the table function block to operate, a TB..EN coil must be active. If the coil is not active, the entire function block will be deactivated.

Up to 16 table fields can be overwritten and read.

5.30.4.1 Enter value in table

When the function block is active, the current value at the double word input at TB..I1 is entered in the table every time there is a rising edge at the WP coil. Coils TB..EN and TB..WP can be actuated simultaneously with a rising edge.

Each new table entry is entered behind the previous one until the sixteenth entry is reached. Immediately after the value of TB..I1 is transferred, this value is output TB..QV. The output TB..QN is increased by 1 and then indicates the actual number of table entries.

If the maximum number of 16 table entries is reached, no more data is transferred to the table and signal contact TB..TF closes. If you wish to make more table entries, read values from the table beforehand or clear the entire table with a rising edge at the RE coil.

A rising edge at the RE coil causes:

- The value at output TB..QN to be set to 0.
- The signal contact TB..TE to close.
- The signal contact TB..TF to open.

5.30.4.2 Reading out the table

The TB..RF and TB..RL coils are used to control whether you are reading out from the start or end of the table.

A rising edge at the RF coil (Read First) removes the first table entry (FIFO function) and outputs it at the output TB..QV. A rising edge at the RL coil (Read Last) removes the last table entry (LIFO function) and outputs it at TB..QV.

The value at output TB..QN is reduced by 1 with each output of a table entry.

5.30.4.3 Example

An operator determines the work required for a particular workpiece, creates a production code for it and writes it in a table.

The workpieces reach the machining stations in this order. When the workpiece is changed, the stations read the required production steps from the table.

As soon as the table has reached 16 entries, the function block disables entry by the operator.

```

TB16      +
>I1 MD10
  QV> MD11
  QN>
  
```

The figure on the left shows the parameter display and the parameter set for the function block TB16. Once function block number 16 has been defined, you set here the operands for the production code at input TB16I1 and the output TB16QV.

The coils and contacts are programmed in the circuit diagram of MFD:

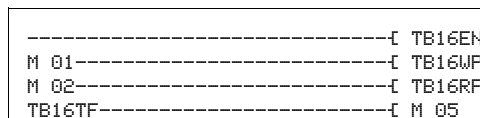

Figure 224: Table function example

- The enable coil TB16EN is permanently active, the function block is not switched off.
- A rising edge on marker M01 switches the write pulse coil TB16WP for reading the production code from MD10 and transfers it to the table.
- The contact TB16TF is used to show the sixteenth entry via the marker M 05 to the operator.
- With a rising edge from marker M02 to TB16RF the processing station reads out the first production code from the table and supplies it at output TB16QV.
- After the sixteenth read process or less, all production codes have been read out and the table is empty. Contact TB16TE closes.

5.31 VC, value limitation

The value limitation function block is used to output values within fixed limit values.

MFD device allows the use of up to 32 value limiters.

5.31.1 Function block inputs/outputs

Value capsuling VC01...VC32 (Value Capsuling)							
Boolean inputs/outputs				Parameters			
Contact		Coil		Input value		Output value	
		EN	Activation of the function block ①				
				I1	Input value ②		
				SH	Upper limit value ③		
				SL	Lower limit value ④		
						QV	Output value ⑤

Read the description of the inputs/outputs in the legend points in the following tables.

5.31.2 Wiring of the function block

You wire the function block in the circuit diagram with its coil.

5.31.2.1 Coil

Parameters	Function
① UC...EN	Selective activation of the function block

5.31.2.2 Example of the value limitation function block:

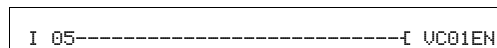

Figure 225: Wiring the function block coil

The enable coil of the function block is connected directly to a device terminal.

5.31.3 Parametric programming of the function block inputs/outputs

5.31.3.1 Parameters

```

VC27      +
>I1
>SH
>SL
QU>
  
```

When using the function block in the circuit diagram for the first time, use OK to automatically enter the general display of function block parameters, as shown in the figure on the left. Enter the function block settings here. The display contains the following elements:

VC27	Function block: Value limiter, number 27
+	Parameter display: Call enabled
② >I1	Input value: -2147483648 - 2147483647
③ >SH	Upper setpoint: -2147483648 - 2147483647
④ >SL	Lower setpoint: -2147483648 - 2147483647
⑤ QU>	Output value within the set limits: -2147483648 - +2147483647

The parameter set consists of:

Parameter display

The display of the parameters during operation can be disabled. Additional information → section "4.9.2.1 Parameter assignment from the circuit diagram", page 191.

Parameters	Function
+	Parameters are displayed
-	Parameters are not displayed

This parameter is factory set to +.

Inputs

>I1: You assign the value to be output within the limit values at the function block input >I1.

>SH und >SL: The upper and lower limit setpoints are set at function block inputs >SH and >SL respectively.

You can assign the following operands to function block inputs >I1, >SH and >SL:

- Constant
- Markers MD, MW, MB
- Analog inputs IA01 to IA04:
 - IA01: Terminal I7
 - IA02: Terminal I8
 - IA03: Terminal I11
 - IA04: Terminal I12
- Analog output QA01
- Output ...QV> of a different function block

Output

The output VC..QV provides the input value within the defined limits as an integer. You can assign the following operands to output ...QV>:

- Analog output QA01
- Markers MD, MW, MB

Memory requirement

The value limitation function block requires 40 bytes of memory plus 4 bytes per constant at the input.

Cycle time

mode	Cycle time [μs]
-	34

5.31.4 Function of the function block



The function block must be enabled so that it can work. Coil VC...EN is active. If coil VC...EN is not active, the entire function block is deactivated and reset. The output value is set to zero.

The value is accepted at input VC...I1 if the enable coil is active. If the value is greater than the upper limit value or less than the lower limit value, the appropriate limit value is output at VC...QV.

5 Function blocks

5.32 Example with timing relay and counter function block

5.32 Example with timing relay and counter function block

A warning light flashes when the counter reaches 10. In this example the function blocks C01 and T01 are wired in the standard circuit diagram and their inputs/outputs are defined.

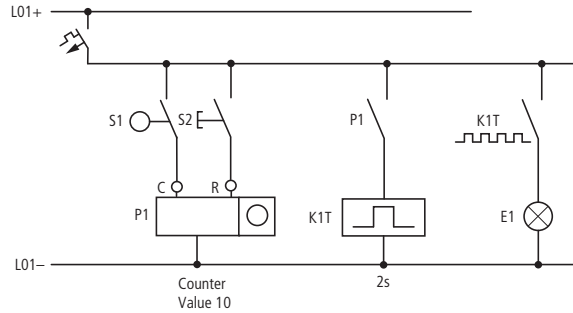

Figure 226: Hardwiring with relays

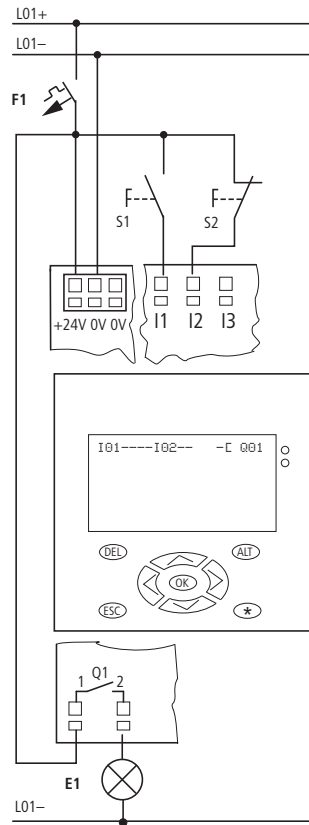

Figure 227: Wiring with MFD

5.32.0.1 Enter circuit diagram

- ▶ Enter the following circuit diagram.

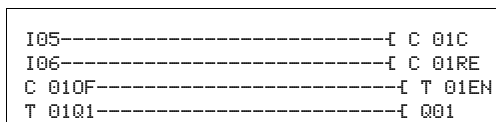

Figure 228: Wiring of counter and timing relay

5.32.0.2 Entering function block parameters

If you enter the coils or contacts of a function block, the inputs/outputs of the function block are displayed that you can parameterize. The parameters can be entered via the function blocks menu.

The meaning of these parameters is explained under each function block type.

Entry:

```

C 01    +
>SH +10
>SL
>SU
  
```

The first part of the parameter set of a counter is displayed.

- ▶ Move the cursor > over the + character to the value input behind >SH:
 - >SH means: Function block input upper counter setpoint value.
 - The + character means that the parameters of this timing relay can be modified using the PARAMETERS menu.
- ▶ Change the upper counter setpoint to 10:
 - Use < > to move the cursor onto the tens digit.
 - Use ^ v to modify the value of the digit.
- ▶ Press OK to save the value and ESC to return to the circuit diagram.
- ▶ Set the parameters for T 01.

```

T 01 11 S +
>I1 002.000
>I2 002.000
QU>
  
```

The timing relay works like a flashing relay. The function is set on the top right beside the number in the parameter display.

The time base is set to the right of the "flashing" function. Leave the time base set to S for seconds.

- ▶ Move the cursor to the right over the + character in order to input the time setpoint value >I1.

If you enter the same setpoint at >I1 and >I2, the timing relay operates as a synchronous flasher.

The + character means that the parameters of this timing relay can be modified using the PARAMETERS menu.

- ▶ Confirm the value input with OK.
- ▶ Press ESC to leave entry.

5 Function blocks

5.32 Example with timing relay and counter function block

Testing the circuit diagram:

- ▶ Switch MFD to RUN operating mode and return to the program.

You can display every parameter set via the function relays menu.

- ▶ Move the cursor onto C 01 and press OK.

The parameter set for the counter is displayed with actual and setpoint values.

- ▶ Move the cursor ∇ downwards until you see the value QV>.
- ▶ Switch input I05. The actual value changes.

```
C 01    +
>SH +10
>SL +0
>SU +0
QV>+0
```

```
C 01    +
>SH +10
>SL +0
>SU +0
QV>+10
```

If the actual and upper setpoint values of the counter are the same, the timing relay switches the warning light on and off every 2 seconds.

Doubling the flashing frequency:

- ▶ Select the power flow display T 01 and change the constant of the setpoint time to 001,000.

When you press OK, the warning light will flash at twice the frequency.

If the setpoint is a constant, it can also be modified via the PARAMETERS menu.

```
T 01 11 S +
>I1 002.000
>I2 002.000
QV> 0.55
```



The actual value is only shown in RUN mode.

6 Visualization with MFD-Titan

In the following description, the term “visualization” is used for the display and operator function. Each visualization requires at least one screen.



Whilst you can enter the program (circuit diagram, function blocks etc.) both via the easySoft-Pro programming software and on the MFD itself, you can only edit the visualization using easySoft-Pro.

6.1 Screens

A screen is used for managing

- Screen elements and
- Button Elements.

The screen editor is used to design the screens, i.e. the displays containing the screen elements. These screen elements consist of items such as graphics. Further information on this → Section “6.4 Screen Editor”, page 369.

Screen elements are also used to establish the logic association with the circuit diagram, e.g. for displaying a value on the screen or for entering a new value via the function keys. Further information on this → Section “6.5.1 Operating principle in the visualization”, page 416.

The access permission to a system that is controlled by a visualization can be implemented with password protection. Further information on this → Section “6.7 Password Protecting Screens”, page 432.

Button elements allow you to assign new functions to an operating button of the MFD which is operative in the visualization. Further information on this → Section “6.6 Button Editor”, page 417.

From easySoft-Pro you then load the visualization together with the program onto the MFD. If the MFD is to be run as a NET station, you can also give the command from easySoft-Pro to load the program and visualization onto a memory card.

This chapter describes the basic operation of the visualization with easySoft-Pro (from version 6.0) using the examples provided. A detailed description of how to create a visualization with the easySoft-Pro programming software is provided in the associated Help system.

6 Visualization with MFD-Titan

6.1 Screens

6.1.1 Exchangeability of MFD-CP8...- and MFD-CP10... screens

Upward Compatibility

In easySoft-Pro you can copy the screens of an MFD-CP8... with a device version number 01, 05 or 08 to the Clipboard and then paste these fully with all screen and button elements into an MFD-CP10... visualization.

Downward Compatibility

Not provided.

6.1.2 Exchangeability of MFD-CP8...- and MFD-CP10... screen elements

Upward Compatibility

In easySoft-Pro you can copy the screen elements of an MFD-CP8... with a device version number 01, 05 or 08 to the Clipboard and then paste these fully into an MFD-CP10... screen.

Downward Compatibility

Not provided.

6.1.3 Exchangeability of MFD-CP8...- and MFD-CP10... languages

Upward Compatibility

You can copy the foreign language text elements of an MFD-CP8... screen to the Clipboard in easySoft-Pro and then paste these into an MFD-CP10... screen.

Downward Compatibility

Not provided.

6.1.4 Exchangeability of MFD-CP8...- and MFD-CP10... passwords

Upward Compatibility

You can copy the passwords of an MFD-CP8... with a device version number 01, 05 or 08 to the Clipboard in easySoft-Pro and then paste these fully into an MFD-CP10... visualization.

Downward Compatibility

Not provided.

6.1.5 Replacing an MFD-CP8...- with an MFD-CP10...

You can simply convert an existing MFD-CP8... project in easySoft-Pro to an MFD-CP10... project.

Requirement: You must use easySoft-Pro from version 6.80.

- ▶ Open the Project View in easySoft-Pro.

- ▶ Right-click the MFD-CP8... to be replaced and choose Replace Device in the context menu.
- ▶ Drag the MFD-CP10... from the Toolbox to the Workbench and select the firmware version if necessary.
- ▶ Save the MFD-CP10... project under a new name.

6.2 User interface easySoft-Pro

After clicking the Visualization button easySoft-Pro shows the three sections of the Visualization View with the Screen overview opened.

6.2.1 Visualization View

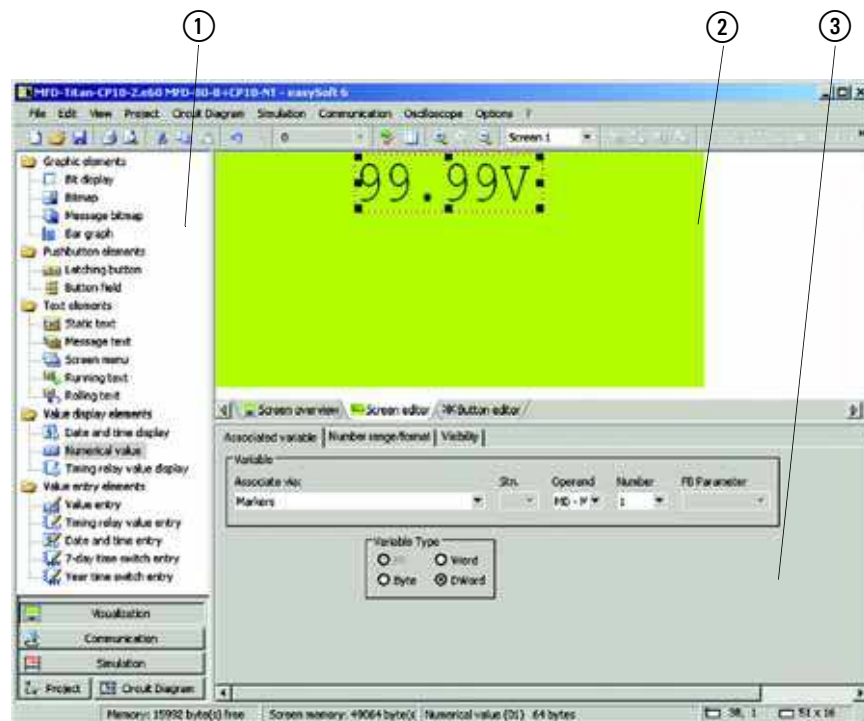

Figure 229: Visualization View

- ① Toolbox
- ② Workbench Window
- ③ Properties Field Window

The Workbench window contains the empty screen 1.

- The left-hand window shows the Toolbox which shows items according to the tab selected in the Workbench:
 - When the screen editor is opened, this will show screen elements that can be dragged and dropped onto the screen in the Workbench in order to design the display.
 - When the button editor is opened, this shows button elements that you can drag onto the list of Button functions on the Workbench in order to assign the function keys of the MFD with new functions.

6 Visualization with MFD-Titan

6.2 User interface easySoft-Pro

- The upper right section shows the Workbench window itself. Double-clicking a screen shown there activates the screen editor and opens the screen for further editing on the Workbench. You can use the Screen overview, Screen editor or Button editor tabs to determine the content of the Workbench and the resulting parameter options. easySoft-Pro remembers the content of the Workbench and shows it again when the visualization is reopened.
- The bottom right section is the Properties field window in which you assign the parameters to your visualization application in stages, using the Screen overview (→ Section "6.3 Screen Overview", page 365), the Screen editor (→ Section "6.4 Screen Editor", page 369) or the Button editor (→ Section "6.6 Button Editor", page 417).

6.2.2 Simulation View

In Simulation View you can carry out other tests as well as check your visualization in the offline status display and also

- view screens.
- Test the entry of values via the entry element of a screen.
- Check the functions that you have assigned to the function keys of the MFD.

In easySoft-Pro you simulate a visualization by showing the display and the pushbuttons of an MFD in the Properties field window.

- ▶ Activate the simulation via <Display -> Display & Pushbuttons-> Start>.

A more detailed description of the simulation tool with the easySoft-Pro is provided in the associated Help system.

6.2.3 Communication View

In Communication View you load your visualization together with the circuit diagram and function block diagram onto the MFD. For this there must be an online connection between the PC and the connected device (see easySoft-Pro Help).

- ▶ Transfer the entire visualization application via <Program/Configuration -> Device => PC>.



After the download you display your visualization in RUN operating state on the display of the MFD.

In this operating mode you can check the circuit diagram for your visualization via the online status display in the Communication View.

It is not possible to show the screen and pushbuttons of the connected MFD in the easySoft-Pro online status display!

6.3 Screen Overview

The screen overview opens in easySoft-Pro when the visualization is called for the first time. In the screen overview create the required screens by assigning them names. You make the general settings for each screen in the Properties field window via the following tabs:

- Screens.
- Passwords.
- Languages.
- Screen activation.

6.3.1 Register "Screens"

In the Screens tab you can create new screens or delete ones that are no longer required.

6.3.1.1 Creating a new screen

- ▶ Click the Name column in the next empty row of the parameter table and enter a screen name.

As soon as you confirm with OK or click the next column, the new screen will appear in the Workbench under the name you have specified.

In the same table row you can assign the Start screen attribute and PW-1, PW-2, PW-3, as well as assign the name of an alternative screen at After abort PW entry.

Start screen

The start screen will appear in the display of the MFD after every program start under the following conditions:

- You have added screens or button elements to the screen and.
- You have not deactivated the Visualization activated option.

The start screen also appears in the simulation of the visualization with easySoft-Pro.

PW-1, PW-2, PW-3

This table is used to set whether the screen is to be password protected and whether access is to be enabled using one, two or three different passwords.

After abort PW entry

This alternative screen appears if you no longer know the password and cancel password entry with ESC.

6 Visualization with MFD-Titan

6.3 Screen Overview

6.3.2 Register „Passwords“

You can define up to three passwords in the Passwords tab in order to control the access to screens and access to a visualization application, → section “6.7 Password Protecting Screens”, page 432.

6.3.3 Register „Languages“

The Languages tab allows you to define the default language and manage up to 254 additional language versions for every text that is output as a text element in a screen.

- ▶ In the Parameter table for an MFD-CP8... or in the Language table for an MFD-CP10... rename the "Untitled" language to your Default language (original language) for example "deutsch" and complete your entry with ENTER.
- ▶ In the next line of the Language column enter the name of the new language.
- ▶ Repeat this entry for all the required languages and assign the appropriate character set Western European, Central European or Cyrillic in the Font column.
- ▶ Once you have edited all text elements in all screens, transfer the texts to a Microsoft Excel spreadsheet by clicking the Export... button.
- ▶ Arrange for the texts to be translated.
- ▶ On receipt of the translated texts, import them into your project by clicking the Import... button.

MFD-CP8...

- ▶ When commissioning the MFD-CP8... select a language as the Download language.

The parameters are transferred with the next program transfer to the device. An MFD-CP8... always show the language that was transferred to the device - the download language. In easySoft-Pro you can change the required download language quickly during commissioning and transfer it. To show a different language, load it as the new Download language.

MFD-CP10...

You can download up to 16 defined languages from easySoft-Pro to an MFD-CP10.. or retain the previous functionality of the MFD-CP8... with a download language. The Language selection during runtime check box is used to select both functions.

Procedure for using several defined languages:

- ▶ Activate the Language selection during runtime check box.
- ▶ When configuring the MFD-CP10... choose the maximum number of 16 download languages with “Yes” in the Download column.
At least one language must be selected with “Yes”.
Languages that are dimmed, for example, when more than 16 of these languages are marked for downloading with “Yes” are not downloaded to the device.

During the runtime, MFD-CP10... displays only one language in the screens. An associated variable is used to toggle to a different language stored in the device.

- ▶ In the Associate via list box define an associated variable, for defining the displayed language during the runtime.
- ▶ Enter the appropriate value in the Value column of the language table. Values between 0 and 255 are permissible.
- ▶ Select the Default language by entering "Yes" in the column of the same name. This is displayed if the associated variable accepts a value to which no language is assigned. One language must be selected as the default language.
- ▶ If necessary select the required character set in the Font column.
- ▶ Transfer the parameters together with the program to the device.

6.3.4 Register „Screen Activation“

The Screen activation function enables you to create a link between the screen to be displayed and a process value.

For this you define a variable containing the numerical value that determines during operation which of the screens is displayed.

- ▶ Select the operand that is to be used as the associated variable.

The Activate Screens operating mode is the same as the function previously provided on an MFD-CP8.... This is particularly suitable for indicating alarm states.

When using an MFD-CP8... from device version number 05 or an MFD-CP10... you can select an additional Roll Screens mode. In this mode, several screens are automatically displayed in succession in a fixed time frame of 4 seconds.



Activated screens should not be password protected!

Screen Activation mode

In the List of Activation Values you assign each screen with the process value that will cause the screen to be displayed. The screens in this list have the same number and order as defined in the parameter table of the Screens tab.

- ▶ Select Screen Activation mode.
- ▶ In the List of Activation Values select the required screens by marking with a "Yes" in the Activate column.
- ▶ Then enter a process value for this screen in the Value column.

6 Visualization with MFD-Titan

6.3 Screen Overview



With Force Screen Change option active and a screen associated with an event, any unsaved entries will be lost if the screen concerned is activated by the event.

In this case it is not possible on the MFD-CP8... to carry out a screen change via the keypad while the associated variable is set by the program.

On the MFD-CP10... the screen change is only carried out if the process value has changed compared to the previous circuit diagram cycle. This makes it possible to combine the function of the screen activation with the Screen change button element.

Force Screen Change

You have to use the Force Screen Change option to select which of two possibly simultaneously occurring jobs should be executed by the MFD first of all. If the option is activated, the MFD aborts every job that has been started and changes to the screen which was set by the variable value.

This Force Screen Change function may abort operations such as value entry, a macro for processing functions on pressing a function key and also a password entry.

The option can be useful for displaying alarm screens. If the Force Screen Change option is not activated, the visualization device will otherwise wait until the currently active job is completed before it switches to the new screen.

Rolling screen mode

Screen rolling mode has the same function as the rolling text function blocks in the display of an easy800. Rolling is activated in the display if you have enabled several screens for this operating mode.

This enabling is activated when a specific bit is set within the associated variable you have defined. This type of bit thus has the function of an Enable input for displaying the screen associated with it. As soon as a "screen" bit is set to 1, the associated screen is including in the rolling operation.

There is no priority control for the order of rolling screens! The order of rolling is the same as the order of the screens in the List of Activation Values.

- ▶ Select the Screen rolling mode.
- ▶ In the List of Activation Values for all required screens select a "Yes" in the Activate column and set in the Bit column the required bit in the associated variable.



The button functions that are to cause a screen change are only active if the process value does not contain a set bit that is assigned to a screen.

This does not apply to the Select Screen Element button function because this selects Entry mode at the same time and interrupts rolling.

Detailed parameter instructions are provided in the easySoft-Pro help.

6.3.5 Current screen tab

The Current Screen tab is available when using an MFD-CP10.... In this tab you can define a readable associated variable with a numerical value that depends during operation on the currently displayed screen and which is updated with every screen change.

This value is the same as the parenthesis value that is displayed in easySoft-Pro in the Screen overview tab of the Workbench window, behind which the respective screen name is displayed. The value is assigned to the screen automatically and cannot be changed by you.

6.4 Screen Editor

Up to 255 screen elements can be used in a screen. For more economical memory usage it is more advisable on the MFD-CP8 to use several screens instead of one screen with several memory intensive elements (→ Section "6.4.1 Screen memory", page 370). The following list shows the screen elements that can be used in the screen editor and from which device version number this is possible:

Graphic elements	→ Page
Bit display (01, from 05 with inverse option)	388
Bitmap (01)	391
Message Bitmap (05)	391
Bar graph (05).	396
Button Elements	
Latching Pushbutton (05)	385
Pushbutton area (05).	386
Text Elements	
Static Text (01)	373
Message text (01, from 05 with the Central European and Cyrillic character sets)	375
Screen menu (05)	382
Running text (05)	383
Rolling text (05)	384

6 Visualization with MFD-Titan

6.4 Screen Editor

Value display elements	
Date and time displays (01)	398
Numerical value (01)	400
Timer relay value display (05).	405
Value entry elements	
Value inputs (01)	406
Timer relay value inputs (05)	411
Date and time inputs (05)	412
Week clock input (05)	413
Yearly timer inputs (05).	414

easySoft-Pro offers you example applications for some screen elements. These are provided under:

C:\Programs\Common Files\Eaton\easySoftSamples\mfd (example applications 1) and under

C:\Programs\Common Files\Eaton\easySoftSamples\MN05002001Z (sample applications 2).

easySoft-Pro offers you a series of symbols for the simple design of Bitmap and Message bitmap graphic elements. These are provided under:

C:\Programs\Common Files\Eaton\Symbols.



As the Bitmap and Message bitmap graphic elements are some of the most memory intensive screen elements, follow the instructions in → Chapter 9 "Inside MFD", page 473.

The following examples illustrate the use of the individual screen elements.

6.4.1 Screen memory

The screen memory stores all the screens that are created with easySoft-Pro.

Size of the screen memory

- MFD-CP8..., 24 kByte
- MFD-CP10..., 48 kByte

How an MFD manages the screens during program runtime is described in → Chapter 9 "Inside MFD", page 473.



The status bar of easySoft-Pro shows the available screens and working memory, as well as the required memory for the active screen element. If the memory available is exceeded, the color of the status bar display changes to red.

6.4.2 Creating masks

You design the individual screens in the Screen editor with the above screen elements. A detailed description of the screen elements is provided in the following sections.

As long as you have opened a screen in the Screen editor but have not activated a screen element, you can display general screen information in the Project Info, Program Info and Screen Info tabs in the Properties field window.

As soon as you have activated a screen element in the screen, you can set this in the Properties field window using the general tabs and element specific tabs.

You can re-display the general screen information by clicking a free space in the screen.

6.4.2.1 Transferring a screen element to the screen

Requirement: You must have already opened a screen in the screen editor.

- ▶ Click the screen element in the Toolbox and hold down the left mouse button whilst dragging it onto the screen.

The specific tabs that you can use for parameterizing this screen element appear in the Properties field window.

- ▶ Position the cursor over the screen element and move it to the required position inside the screen whilst holding down the left mouse button.



In the description of the screen elements it is always assumed when programming in easySoft-Pro that the screen element to be edited is already in the required screen position and is selected.

To program a button element in easySoft-Pro, you must have switched to the Button editor and must have assigned the button element to a button.

The height and width of the element frame can be scaled as required and is adjusted accordingly by enlarging or reducing the screen element frame horizontally or diagonally. This is done by dragging the selection square of the element frame with the mouse button depressed.

The height of some screen elements is adjusted according to the font size. Three sizes are possible:

- Normal font.
- Double font size.
- Fourfold font size.

6 Visualization with MFD-Titan

6.4 Screen Editor

The font size can be changed in the context menu (right mouse button) using a button in the toolbar or by dragging the frame handle at the bottom edge of the screen element frame. To increase the font size, sufficient space must be available underneath the element.

The width of the element is freely scalable up to a limit that is determined by the font size. Dragging a selection square with the mouse button depressed will set the required size. It must be ensured that the elements are large enough in all languages.



If a font size is selected too large, or if the size of a numerical value or value entry screen element is not big enough, the programming software easySoft-Pro will output a string of special characters ———.

When the correct proportions are used, the maximum number of 16 characters per line is permissible.

In this case, the screen will then not be able to be loaded in the MFD so as to indicate that the display will not be shown in its entirety.

6.4.2.2 Aligning, cutting, copying, pasting or deleting screen elements

If you wish to align, move, copy or delete screen elements or change their size, you can select them and then carry out the operation required. Screen elements can be selected singly or multiply. For further information see the easySoft-Pro help.

6.4.2.3 General tabs for parameterizing a screen element

- Visibility tab: Choose here a Boolean variable via which the screen element is shown/hidden during operation.
- Display change tab: Select here a Boolean variable via which the screen element is changed from normal to inverse or flashing during operation.
- Operability tab: Choose here - for all screen elements used for entering a value - a Boolean variable via which entry is disabled.



The correct parameterization of a screen element can be checked in easySoft-Pro with the plausibility check (F10).

6.4.2.4 Creating Texts with Special Characters

Displayable characters in the Western European character table (→ Section "11.6 Basic and extended Western European character set", page 522)

You can use the Windows character table to enter special characters that you wish to show in the display of a visualization device which cannot be entered directly via the PC keypad.

- ▶ Open the Windows XP character map via Start, Programs, Accessories, System Tools, Character Map or alternatively with
- ▶ Start, Run, Charmap.
- ▶ Select the Arial font in the Font list box.
- ▶ Select the Unicode character set in the Font list box of this table.
- ▶ Then choose the required character(s) and copy this (these) to the Clipboard.
- ▶ Then add the character(s) to the required display line of the text display.

If you know the Unicode equivalent of the character you can enter its Unicode number via the number keypad with the NUM LOCK pushbutton activated and the ALT pushbutton held down at the same time.

Characters that cannot be displayed are shown in the Text display preview as an empty frame element ?.

The text elements are described below.

6.4.3 Static Text

The static text element is a simple text display element that is shown as soon as the screen is active. The normal element size can show up to 16 characters in a text field and up to 4 lines can be arranged vertically. When using double font size, half the number of characters per text field and number of displayable characters is possible. The Static text can be assigned to the language in the language selection. The language selection is defined in the screen overview.

Programming in easySoft-Pro

- ▶ Enter the required text in the Static text tab.

If the text is not completely shown in the screen, enlarge the screen element or reduce the font.

- ▶ If necessary select a different language in the Language selection list box to which the text is to be assigned.

You define the languages in the Languages tab in the Screen overview. These apply to the text elements of all screens.

Visibility and Display change tabs, → Section "6.4.2.3 General tabs for parameterizing a screen element", page 372.

Application examples 1:

The example programs MFD-Titan-CP10.e60 and MFD-Titan-CP8.e60 show the use of a Static text screen element in the Function_(EN_)Static_text(_2) and Function_EN_Static_text(_2) screens. The MFD-Titan-CP10.e60 example program also includes the improved language change function of the MFD-CP10....

Application examples 2:

The example programs StaticText_Prog_01.e60 to StaticText_Prog_03.e60 are based on the MFD-CP8....

StaticText_Prog_01.e60 (different display types)

The program consists of four screens in which the static text is displayed in different ways. The individual screens can be selected with the cursor buttons \wedge and \vee . The screen change was defined in the button editor (→ Section "6.6 Button Editor", page 417).

Screen 1 shows a static text in normal font size.



Screen 2 shows a static text enlarged.

Screen 3 shows three static texts in different font sizes.

Screen 4 shows four static texts arranged vertically.

StaticText_Prog_02.e60 (different display types with password request for a screen)

The program consists of four screens in which the static text is displayed in different ways. The fourth screen contains a password request. The individual screens can be selected with the cursor buttons \wedge and \vee . The screen change was defined in the button editor (→ Section "6.6 Button Editor", page 417).

When calling screen 4 the defined password is requested. In this case, this is the number 2 which must be confirmed with OK. You can leave the password request dialog by pressing ESC, which will cause a return to the previous screen.

Screen 1 shows a static text in normal font size.

Screen 2 shows a static text enlarged.

Screen 3 shows three static texts in different font sizes.

Screen 4 shows four static texts arranged vertically.

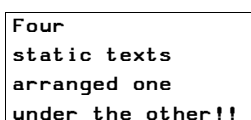

StaticText_Prog_03.e60 (different display types with screen activation using a counter)

The program consists of four screens in which the static text is displayed in different ways. The individual screens are activated via the counter C01. This has the value 5 as the upper switch value SH. The pulse for activating the screens is supplied by timing relay T01. The possible counter values are therefore 0 to 5. Counter value 1 activates screen 1, counter value 2 screen 2 etc. If the upper switch value of the meter has been reached, timing relay T02 is started which resets the meter. This therefore produces a continuous loop. The timing relay T02 causes a reset delay of the counter.

Screen 1 shows a static text in normal font size.

Screen 2 shows a static text enlarged.

Screen 3 shows three static texts in different font sizes.

Screen 4 shows four static texts arranged vertically.

6.4.4 Message Text

This screen element makes it possible to display texts that are stored in a text table inside the program. A text can have a maximum length of 16 characters. If the text is shorter than the element, the text is provided with additional blanks for the output. A message text is used for indicating status changes in the process. In order to visually display changes of this kind, you can link message texts with a variable (associated variable). As soon as the variable assumes defined value, the MFD will output the associated message text. The default text is output if the variable assumes a value that is not assigned to a text.

Programming in easySoft-Pro

- ▶ Drag the Message text element onto the screen with the left mouse button depressed.
- ▶ Position the cursor over the screen element and move it to the required position whilst holding down the left mouse button.

The height of the screen frame depends on the text size for which two sizes are possible:

- Normal font.
- Double font size.

The font size can be changed in the context menu (right click) or by dragging the selection square at the bottom of the element frame. There must be sufficient space below the element so that the font can be changed. The width of the screen element frame can be scaled as required by dragging the selection squares on the side.

6 Visualization with MFD-Titan

6.4 Screen Editor



Ensure that the screen elements are large enough to accommodate the texts for all languages used. This can be checked in the screen overview.

In the Associated variable tab you define the Boolean variable with the status value that determines the output text.

In the Message texts tab

- assign the relevant status value of the associated variable to the different message texts,
- select the language in which the text is to be output and
- enter a default text.

The "Visibility" tab enables the screen element to be hidden using an associated variable.

The "Display change" tab offers the following display options which can be controlled via an associated variable:

- flashing.
- Inverse

Application examples 1:

The example programs MFD-Titan-CP10.e60 and MFD-Titan-CP8.e60 show the use of a message text screen element in the Function_(EN_)Message_text(_2) and Function_EN_Message_text(_2) screens. The MFD-Titan-CP10.e60 example program also includes the improved language change function of the MFD-CP10....

Application examples 2:

The example programs MessageText_Prog_01.e60 to MessageText_Prog_05.e60 are based on the MFD-CP8....

MessageText_Prog_01.e60 (Controlling message texts with Boolean variables)

The program consists of seven screens that you can select via cursor buttons \wedge and \vee . The screen change was defined in the button editor (\rightarrow Section "6.6 Button Editor", page 417). The circuit diagram uses six on delayed timing relays that activate outputs Q1 to Q4 as well as LE 03 in succession after the elapsed time. The process is carried out in a continuous loop since the timing relay T06 resets all timing relays after the set time. In all screens the message texts are activated via Boolean operands. As these operands only have two states (0/1), only a maximum of two different messages can be output for each message text element. Other variable types will allow the output of correspondingly more messages per message text element.

Screen 1 illustrates the activation of the message texts using the associated variable. The output of two different texts in one message text element is demonstrated. Four message texts elements are provided in the first screen. These are triggered in succession via the outputs Q1 to Q4 and appear in the display.

In the Message text tab, the states of the associated variable are assigned to the particular message to be output. In this example, the message “no data” will be output when Q1 = 0, and “Information” will be output when Q1 = 1. All other message text elements have only one message text which is displayed when Q.. = 1 for the relevant output.

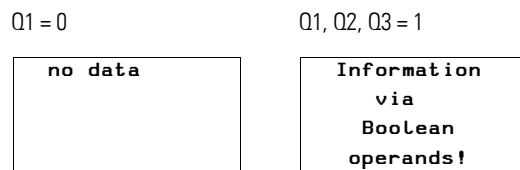
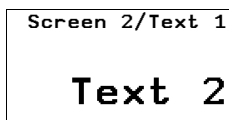

Figure 230: Text display via Boolean operands



Screen 2 illustrates the activation of the message texts using the associated variable. A message text is also displayed enlarged. The first screen shows two bit message text elements. These are triggered in succession via the outputs Q1 to Q3 and appear in the display. The texts are only displayed if the corresponding outputs are set to 1. No message text is assigned to status 0.

Screen 3 illustrates the actuation of a bigger message text element with two message texts assigned to the current status value of output Q2.

Q2 = 0 a message text Q2 OFF
Q2 = 1 a message text Q2 ON



Figure 231: Message texts via an associated variable

Screen 4 is basically the same as screen 3, but has the visibility element in addition. The input I1 can be switched to hide the message text. The setting for this was made in the Visibility tab. The selected bit logic is a N/O. When using a N/C bit logic, the message text element is shown when I1 is actuated.

6 Visualization with MFD-Titan

6.4 Screen Editor

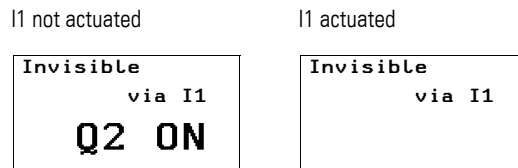

Figure 232: Masking out message text

Screen 5 is essentially the same as screen 4 in which the Invisibility function is replaced by a Flashing display change. Input I2 = 1 (N/O contact bit logic) switches the message text flashing.

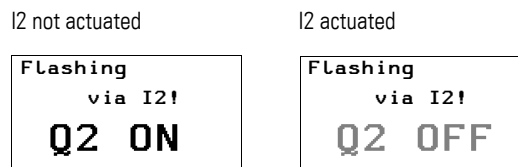

Figure 233: Message text flashing

Screen 6 is essentially the same as screen 5 but with the Inverted display change selected. Input I2 = 1 (N/O contact bit logic) inverts the message text in this screen.

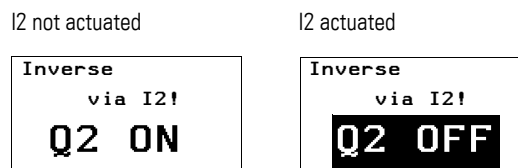

Figure 234: Message text inverted

Screen 7 is essentially the same as screen 6, but the inverted display is controlled by a timer T07 (asynchronous pulse generator). The text flashes in the display with different pulse and pause times.

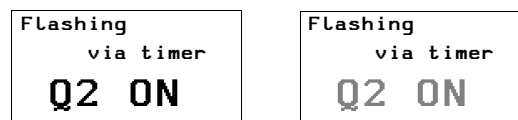

Figure 235: Message text inverted flashing

MessageText_Prog_02.e60 (Controlling message texts with timing relay)

The program consists of two screens containing message texts. The screen activation automatically shows the screens on the display in succession. The circuit diagram uses six on delayed timing relays T01 to T06 that activate outputs Q1 to Q4 as well as LE 03 in succession after the elapsed time. The operation is carried out in a continuous loop since the timing relay T06 resets all timing relays after the set time.

The screen activation is implemented via counter C01. This contains the value 1 as the upper set value SH. This therefore produces the counter values 0 and 1 that are used for both screens as activation values. When the timing relays T01 to T06 are reset by T06, counter C01 is activated which reaches the status value 1 and therefore its upper set value, causing screen 2 to be displayed. The on delayed timing relay T08 sets the counter C01 back to zero after the set time (0.8 s), causing screen 1 to be displayed again the timing relay T08 is no longer activated. The loop is continued.

Example application: Messagetext_Prog_02.e60

Start Machine 1
Start Machine 2
Start Machine 3
Start Machine 4

Screen 1 shows four bit message text elements. These are triggered in succession via the outputs Q1 to Q4 and appear in the display.

Restart

Screen 2 contains a message text element with a message text.

MessageText_Prog_03.e60 (Message text with display change)

The program consists of two screens containing message texts. The screen activation automatically shows the screens on the display in succession. This program is an expansion of the program Messagetext_Prog_02.e60. The expansion consists of screen 2 containing two messages in one message text element which are toggled automatically. A display change is also carried out in one message text. The circuit diagram uses six on delayed timing relays T01 to T06 that activate outputs Q1 to Q4 as well as LE 03 in succession after the elapsed time. The operation is carried out in a continuous loop since the timing relay T06 resets all timing relays after the set time. In the circuit diagram, N/O contacts (C01ZE) of the meter are switched directly before the outputs Q1 to Q4 as well as before LE 3. The outputs must only be active with screen 1, i.e. when the meter is set to 0.

The screens are activated via counter C01. This has the value 2 as the upper switch value SH. This produces the counter values 0, 1 and 2. The counter value 0 activates screen 1, counter value 1 activates screen 2 and counter value 2 activates the second message text in screen 2. When the timing relays T01 to T06 are reset, the counter receives a pulse and is incremented by one value. When counter C01 reaches its upper set value on the second pass, the on-delayed timing relay T08 starts. After the set time (0.8 s) this resets the counter C01 to 0. The loop is repeated continuously in this way.

Start Machine 1
Start Machine 2
Start Machine 3
Start Machine 4

Screen 1 shows four bit message text elements. These are triggered in succession via the outputs Q1 to Q4 and appear in the display.

6 Visualization with MFD-Titan

6.4 Screen Editor

Screen 2 contains a message text element with two message texts. In all screens the message texts are activated via the counter values "1" and "2". When the timing relays are reset by T06, counter C01 is activated which reaches the status value "1", and the "Error" message appears. It flashes as specified in the Display change tab where the FB parameter is set to ≤ 1 . If the status value of C01 is 2, RESTART is displayed.



Figure 236: Message text as status indication

MessageText_Prog_04.e60 (Message texts with default text)

The program consists of two screens containing message texts. The screen activation automatically shows the screens on the display in succession. This program is an expansion of the program MessageText_Prog_03.e60. This consists of the display of a default text in screen 2 when the counter takes on values for which no messages have been assigned. The circuit diagram uses six on delayed timing relays T01 to T06 that activate outputs Q1 to Q4 as well as LE 03 in succession after the elapsed time. The process is carried out in a continuous loop since the timing relay T06 resets all timing relays after the set time. In the circuit diagram, N/O contacts (C01ZE) of the counter are switched directly before the outputs Q1 to Q4 as well as before LE 03 so that the outputs are only active with the display of screen 1 when counter C01 is 0.

The screen activation is implemented via counter C01. This has the value 4 as the upper set value SH. This produces counter values 0, 1, 2, 3 and 4. The counter value is reset when timing relays T01 to T06 are reset. Counter value 0 activates screen 1, counter value 1 activates screen 2. Screen 2 stays active for counter value 2 to 4, with counter value 2 and 3 assigned a default text as there are no message texts assigned to these counter values. Counter value 4 shows the message text RESTART in screen 2. This value also reaches the upper set value which activates the on-delayed timing relay T08. This resets the counter C01 back to 0 after the set time of 0.8 s. The loop is continued.

Start Machine 1
Start Machine 2
Start Machine 3
Start Machine 4

Screen 1 shows four bit message text elements. These are triggered in succession via the outputs Q1 to Q4 and appear in the display.

Screen 2 shows a message text element with two message texts. The counter values 1 and 4 activate the message texts. A "default" text is also entered.

- Status value 1: Message text "Error"
- Status value 2 and 3: Default text "default"
- Status value 4: Message text "RESTART"

If the status value of C01 is 1, the message text "Error" is displayed flashing since the function block parameter FB is set in the Display change area of the Display change register. The function block parameter switches if the SL value (lower set value) of the counter is reached (→ easySoft-Pro Function block editor counter C01).

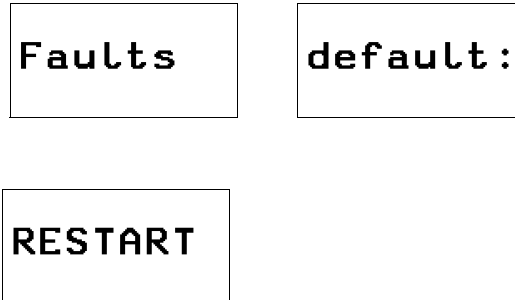

Figure 237: Message text with default text

MessageText_Prog_05.e60 (Several message texts in one text element)

The program consists of three screens that you can select via cursor buttons ^ and v. The screen change was defined in the button editor (→ Section "6.6 Button Editor", page 417). The program is used to display several messages in one message text element. It also illustrates the function of the Visibility tab and the Display change tab. The pulse generator T01 activates the counter C01. This counts up to seven and then resets itself. This produces a continuous loop in which the individual messages are activated.

Screen 1 shows a message text element with six message texts.

- Status value 1: Message text "These"
- Status value 2: Message text "are six",
- Status value 3: Message text "message texts"
- Status value 4: Message text "in one"
- Status value 5: Message text "message text"
- Status value 6: Message text "element!"

It can be seen that the messages can be moved within the entry field.

Screen 2 is virtually the same as screen 1, apart from the additional feature that the message text element can be hidden via I1 (N/O bit logic). The use of the N/C bit logic would make the element visible.

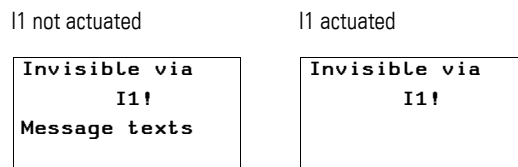

Figure 238: Switching message text invisible

6 Visualization with MFD-Titan

6.4 Screen Editor

Screen 3 is virtually the same as screen 1 apart from an expansion in which the first message text element flashes and the second is displayed inverted when I1 is actuated.

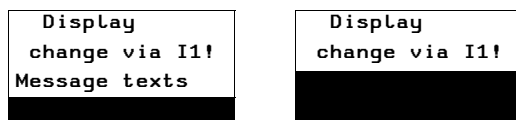

Figure 239: Message text flashing and inverted

6.4.5 Screen Menu

The Screen menu entry element can be used to enable the operator to change to a different screen during operation by the cursor buttons.

All screens (max. 255) that you have entered in the Parameter table can be scrolled through vertically in the display in the same order. The selectable screens are shown in the Screen menu entry element by the name given to them in the Name column of the Parameter table.

You must enter the Screen menu entry element in every screen and all other screens in the Parameter table if it is necessary for the operator to be able to move from any screen to any other one.



If you have also defined a program controlled change to another screen as well as this screen menu entry element, this screen activation will have priority. The screen entry element can therefore only be used if the program controlled screen activation is not active!

Table 30: Example table of the screen menu for screen 4

	Value to be set	Name
1	● Screen 1	Start picture
2	Screen 2	Main menu
3	Screen 3	Recipe 1

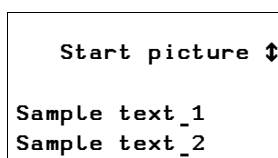

In this example, the operator can switch to display the start picture, main menu and recipe screens via the screen menu element when Entry mode is activated and when screen 4 is displayed.

The general procedure for using screen entry elements, → Section "6.5.1 Operating principle in the visualization" on page 416 .

Programming in easySoft-Pro

Table of the screen menu tab:

- ▶ Enter in the Screen column of the parameter table the screen that is to be selectable.
- ▶ Under the Name column enter the name by which this screen is displayed.

easySoft-Pro will propose the screen name to simplify the process.

- ▶ To enter a foreign language text, choose the appropriate language in the Language selection list that you previously defined in the screen overview.

If you only wish to work with one standard language and have not defined an additional language, the selection box will always show "Untitled".

Visibility and Display change tabs → Section "6.4.2.3 General tabs for parameterizing a screen element", page 372.

Application examples:

The example program MFD-Titan-CP10.e60 illustrates the use of the Screen menu element in the Menu_Function and Menu_Language screens and the MFD-Titan-CP8.e60 shows this in the Menu_EN_Function screens and Menu_DE_Funktion screens as well as Menu_Language screens. The example program MFD-Titan-CP10.e60 allows a language selection of the stored texts.

6.4.6 Running Text

This single-line screen display element enables you to output a running text as frequently seen in TV news bulletins. Up to 63 characters of the static text can be moved continuously through the display area from right to left. Spaces count here as a normal character. After the last character is output, the display is continued with the first character. The running text can be displayed in normal or double font size.

Programming in easySoft-Pro

Running text tab:

- ▶ Enter the text in the Text field.
- ▶ To enter a foreign language text, choose the appropriate language in the Language selection list that you previously defined in the screen overview.

If you only wish to work with one standard language and have not defined an additional language, the selection box will always show "Untitled".

Visibility and Display change tabs → section "6.4.2.3 General tabs for parameterizing a screen element", page 372.

6.4.7 Rolling Text

This single-line screen display element allows you to output text that consists of more characters than can be shown in one display line.

All text entries that you entered in lines in the parameter table are shown consecutively in one text line. The individual table rows are displayed for two seconds unless they are hidden. When the last table row entry has been reached, the display restarts with the first text entry of the table. The display order is the same as the order of the entries Parameter table.

You can output up to 255 table lines of 16 characters each in one screen display element.

There are two text display methods: "Text display depending on an associated variable" and "unconditional text display".

Text Display Depending on Associated Variable

You can selectively show or hide individual text lines using the individual bits of a byte, word or Dword associated variable. During operation, all text lines with their assigned bit set at 1 are shown in the rolling text.

Example

The value of the associated variable is 7. All texts are displayed consecutively that were edited at bits 1, 2 and 3. Texts that were stored at bit 4 and higher are not displayed.

Unconditional text display

All the text lines entered in the parameter table are displayed in succession if you activate the Unconditional Text Display option in the Rolling Text tab and do not use any associated variables.

Programming in easySoft-Pro

"Associated variable" tab:

- ▶ Define the variable type and the associated variable which is to show or hide individual text lines according to its status.

Only make this selection if you choose the "Text Display Depending on Associated Variable" option in the Rolling text tab.

"Rolling text" tab:

- ▶ First select the "Text Display Depending on Associated Variable" or the "Unconditional Text Display" option.
- ▶ Enter the text lines in the Text column of the parameter table. Depending on the previous selection stating the bits or none.
- ▶ To enter a foreign language text, choose the appropriate language in the Language selection list that you previously defined in the screen overview.

If you only wish to work with one standard language and have not defined an additional language, the selection box will always show "Untitled".

"Visibility and Display change" tabs → Section "6.4.2.3 General tabs for parameterizing a screen element", page 372.

Example application:

The example program MFD-Titan-CP8.e60 contains the Rolling text display element for the Unconditional text display option in the German screen Funktion_DE_Rollierender_Text_2 and in the English screen Funktion_EN_Rolling_text_2. The screen display element with the option Text display depending on associated variable is used in the German screen Funktion_DE_Rollierender_Text and in the English screen Funktion_EN_Rolling_text.

The multi-lingual example program MFD-Titan-CP10.e60 contains the Rolling text display element for the Unconditional text display option in the Function_Rolling_text screen and for the option Text display depending on associated variable in the screen Funktion_EN_Rolling_text_2.

The following section describes the button elements.

6.4.8 Latching pushbutton

This screen entry element enables the operator to change the state of an associated Boolean operand or a Boolean function block input by simply pressing the OK button.

This screen entry element has the same function as the changeover relay button element. This screen entry element is shown for visual indication on the display as a check box with static text to its right.

Display change

The current operand state is shown as a tick in the check box for 1 and without a tick for 0.

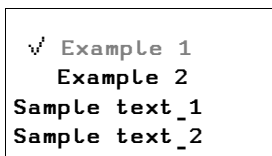

Operation

Already in Selection mode (→ Section "6.5.1 Operating principle in the visualization", page 416), when the screen entry element is selected, the status of the associated variable is changed by pressing the OK pushbutton. The entry is automatically completed on pressing the button and the MFD switches to the next screen entry element if present.

6 Visualization with MFD-Titan

6.4 Screen Editor

Programming in easySoft-Pro

Register Associated variable/Name:

- ▶ Define the Boolean associated variable with the state to be switched on or off.
- ▶ Enter the explanatory text in the Text field the Name area.
- ▶ To enter a foreign language text, choose the appropriate language in the Language selection list that you previously defined in the screen overview.

If you only wish to work with one standard language and have not defined an additional language, the selection box will always show "Untitled".

Visibility and Display change tabs → Section "6.4.2.3 General tabs for parameterizing a screen element", page 372.

Example application:

The example program MFD-Titan-CP8.e60 contains in the German screen Funktion_DE_Rastender_Taster and in the English screen Function_EN_Latching_button three Latching button display elements via which the status of the associated Boolean operands LE1-LE3 can be changed.

The example program MFD-Titan-CP10.e60 contains in the multi-lingual screen Function_EN_Latching_button three Latching button display elements via which the status of the associated Boolean operands LE1-LE3 can be changed.

6.4.9 Button Field

This screen entry element combines between 2 and 255 individual buttons into one button field, via which the value of the associated set variable can be changed.

The operator can never activate more than one pushbutton, i.e. can only set a defined value. The activation of a pushbutton automatically causes all other pushbuttons in the pushbutton field to be deactivated.

The number of buttons is determined by the number of set values that you define for this variable in the button field table. For a byte, word or Dword type set variable, up to 255 buttons can be set for each button field. Each pushbutton is assigned a unique set value in the button field table (see below).

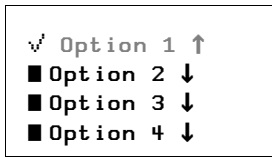

Display change

A button field is displayed in one to four rows on the display, i.e. with one to four buttons, depending on the parameter set.

The output line contains the static text name of the button with a preceding placeholder for a graphical symbol. The tick symbol indicates that a button is "Activated", whilst a small black square indicates "Not activated". This therefore indicates whether the set variable contains the stored set value or not.

The output line can also contain an arrow symbol if other output lines are present that are currently not shown.

Operation

- ▶ As an operator you press the OK button in the visualization in order to activate Selection mode.
- ▶ In Selection mode position the cursor with the <> ^ v buttons on a button field, if the screen contains several screen entry elements.
- ▶ Then press the OK button to move from Selection mode to Entry mode.
- ▶ Use the ^ v pushbuttons to position the cursor on a pushbutton to which the required value is assigned.
- ▶ Then press the OK button to transfer the new value to the set variable.

A tick is added to the activated pushbutton and the MFD returns to Selection mode.

Programming in easySoft-Pro



Position the screen entry element at the very top edge of the screen if you wish to display the maximum of four buttons.

"Set variable" tab:

- ▶ Define the variable type and the set variable which is to contain the value to be changed via pushbuttons.

"Table of the button field" tab:

Table 31: Example table of the button field

	Value to be set	Name
1	● 0	Option1
2	1	Option2
3	2	Option3

- ▶ Enter the value in the Value to be set column and the unique button name in the Name column.
- ▶ To enter a foreign language text, choose the appropriate language in the Language selection list that you previously defined in the screen overview.

6 Visualization with MFD-Titan

6.4 Screen Editor

If you only wish to work with one standard language and have not defined an additional language, the selection box will always show "Untitled".

Visibility and Operability register → Section "6.4.2.3 General tabs for parameterizing a screen element", page 372.

Example application:

The example program MFD-Titan-CP8.e60 contains in the German screen Funktion_DE_Tasterfeld and in the English screen Function_EN_Button_field the Button field display element via which the value of the associated Set variable MW11 can be changed.

The example program MFD-Titan-CP10.e60 contains in the multi-lingual screen Function_EN_Button_field the Button field display element via which the value of the associated Set variable MW11 can be changed.

6.4.10 Bit Display

The Bit display screen element has an input that you can link with a Boolean variable so that it can indicate the signal state of the variable. The signal state of this variable changes the bit display in the MFD display from a solid element to a hollow frame element.

Normally, i.e. without an activated inverse display, the selection of a N/O bit logic causes a frame to be shown on signal state 0 and a solid element to be shown on signal state 1.

The following tables explain the different display options.

Table 32: Appearance of the Bit screen display element without an associated variable for display change.

Signal status	Resulting "bit display appearance"	
Associated variable (bit logic = N/O)	Variable for display change	
0	(not associated)	<input type="checkbox"/>
1	(not associated)	<input checked="" type="checkbox"/>

Table 33: Display of the Bit display screen display element with the Inverse display change activated and identical bit logic for both variables.

Signal status	Resulting "bit display appearance"	
Associated variable	Variable for display change	
0	0	<input type="checkbox"/>
0	1	<input checked="" type="checkbox"/>
1	0	<input checked="" type="checkbox"/>
1	1	<input type="checkbox"/>

➔ The bit display is shown with a solid background and cannot therefore be displayed transparently. It can however be hidden. If there is an overlap, the first bit display is displayed at the back and the last bit display displayed at the front. This arrangement can be changed for the activated screen display element via the four symbol buttons in the menu bar (foreground/background switch) .

➔ Large area bit displays require a high level of processing capacity and should therefore be avoided in applications where the runtime is critical.

Programming in easySoft-Pro

"Associated variable" tab:

- ▶ Define the Boolean variable with the state to be represented by the bit display.

Visibility and Display change tabs ➔ Section "6.4.2.3 General tabs for parameterizing a screen element", page 372.

Application examples 1:

The example program MFD-Titan-CP8.e60 contains in the German screen Funktion_DE_Bitanzeige and in the English screen Function_EN_Bit_display the Bit display screen element.

The MFD-Titan-CP10.e60 example program contains the Bit display element in the multi-lingual screen Function_Bit_display.

Application examples 2:

The example programs Bitdisplay_Prog_01.e60 and Bitdisplay_Prog_02.e60 show other applications of this screen element.

Bitdisplay_Prog_01.e60 (associated variable and visibility)

The program consists of five screens that you can select via cursor buttons ^ and v. The screen change was defined in the button editor (➔ Section "6.6 Button Editor", page 417).

The circuit diagram uses six on delayed timing relays that activate outputs Q1 to Q4, as well as LED 3 in succession after the elapsed time. The process is carried out in a continuous loop since the timing relay T06 resets all timing relays after the set time.

6 Visualization with MFD-Titan

6.4 Screen Editor

Screen 1 illustrates the control section of the bit display solely using the associated variable. The first screen shows four bit display elements. These are triggered in succession via the Boolean operands Q1 to Q4. N/O contact is selected as the bit logic by which the bit display elements assume the status of the corresponding outputs (on/off).

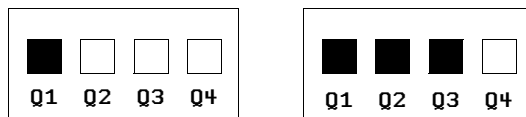

Figure 240: Bit display and static text

Screen 2 illustrates the control section of the bit display with superimposed static text, exclusively using the associated variable. The second screen shows four bit display elements. These are triggered in succession via the Boolean operands Q1 to Q4. N/O is selected as the bit logic by which the bit display elements assume the status of the corresponding outputs (on/off). The bit display is partly covered by the static texts.

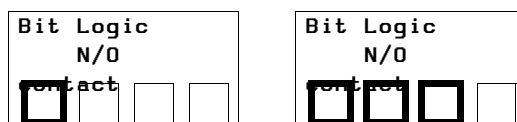

Figure 241: Bit display with superimposed static text

Screen 3 illustrates the options of the "Visibility" tab of the bit display. This screen contains a bit display element that was enlarged to the size of the entire screen. It is actuated via the Boolean operand Q1 with a N/O bit logic, so that the bit display element takes on the state of output Q1 (on/off).

The bit display is switched invisible via the Boolean operand Q3. The bit logic here is also set to N/O, the bit display is therefore invisible as long as Q3 is On. During the Reset pulse only the frame of the bit display is visible (the bit display status is Off, bit display is visible). The display is partly covered by static texts.



Figure 242: Bit display visible/invisible

Screen 4 illustrates the control section of the bit display (negated) with superimposed static text, solely using the associated variable. This screen shows four bit display elements. These are triggered in succession via the Boolean operands Q1 to Q4. N/C was selected as bit logic. The bit display is partly covered by the static texts.

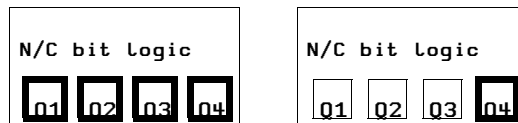

Figure 243: N/C bit display logic with superimposed text

Screen 5 illustrates the options of the Visualisation register of the bit display (negated) with superimposed static text. This screen contains a bit display element that was enlarged to the size of the entire screen. This is triggered via the Boolean operand Q1 with the N/C bit logic set. This causes the bit display to assume the opposite state of the output Q1, i.e. when Q1 is On, only the frame of the bit display is visible. However, the bit display is made visible via the Boolean operand Q3 as the N/C bit logic is selected. The display is partly covered by static texts.



Figure 244: Bit display with frame

Bitdisplay_Prog_01.e60 (Bit display with automatic screen change)

This program is a copy of the program Bitdisplay_Prog_01.e60. The difference is only in the fact that the screens are activated automatically in succession. (Screen change defined in the Screen overview → Screen activation tab → Activate Yes).

The program consists of five screens containing the bit displays.

6.4.11 Bitmap

The Bitmap screen display element enables graphics you have made or purchased to be shown in the MFD display. Display and visibility can be changed during operation. To do this, associate the bitmap graphics with Boolean variables.

easySoft-Pro supports the following bitmap graphic formats:

- Windows bitmap format (bmp).
- JPEG format (jpg).
- Tiff format (tif).
- Icons (ico).

The formats are converted to monochrome and stored accordingly in the program. The size and the position of the bitmap graphic can be modified in the screen editor at a later time.



Bitmap graphics take up a large amount of memory. Covered bitmaps are also stored in their entirety in the memory. The more bitmaps are used, the larger the memory requirement and the cycle time is also considerably increased. This may possibly cause malfunctions in the program (e.g. loss of count pulses). The ideal graphic is black and white. It should be between 16 x 16 and 32 x 32 pixels in size.

Programming in easySoft-Pro

- ▶ Drag the Bitmap element onto the screen with the left mouse button depressed.

This will open the Picture File Selection dialog.

For optimum display of the graphic file select one of the three conversion processes provided in the Conversion Type area. The Preview shows the selected bitmap and the converted result.

- ▶ Position the cursor over the screen element and move it to the required position whilst holding down the left mouse button.

The height and width of the element frame can be scaled as required and is adjusted accordingly by enlarging or reducing the screen element frame horizontally or diagonally. This is done by dragging a selection square of the element frame with the mouse button depressed. The side ratios of the original graphic are retained when you use the diagonal zoom function.

The Display tab offers the following display formats of the bitmap:

- Bitmap flashing (via associated variable),
- Background transparent or covered,
- Inverse

The Visibility tab enables the screen element to be hidden using an associated variable.

Application examples 1:

The example program MFD-Titan-CP8.e60 contains in the German screen Funktion_DE_Bitmap and in the English screen Function_EN_Bitmap the Bitmap indication element.

The MFD-Titan-CP10.e60 example program contains the Bitmap display element in the multi-lingual screen Function_Bitmap.

Application examples 2:

The example programs Bitmap_Prog_01.e60 to Bitmap_Prog_03.e60 show other applications of this screen element.

Bitmap_Prog_01.e60 (Bitmap display)

The program consists of eight screens that you can select via cursor buttons \wedge and \vee . The screen change was defined in the button editor (\rightarrow Section "6.6 Button Editor", page 417).

This program illustrates the bitmap display options using simple examples.



Screen 1 shows a bitmap without any special features, displayed small.

Screen 2 contains a bitmap that is shown enlarged. The Bitmap flashing area of the Display tab also has an association set via Boolean operand I1. If I1 is actuated, the bitmap flashes.



Figure 245: Flashing Bitmap



Screen 3 contains three bitmaps arranged in different sizes next to each other.

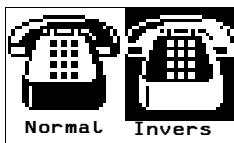

Screen 4 contains two bitmaps arranged in different sizes next to each other. The "Invert Bitmap Display" box on the "Display" register controls the inverted display.

Screen 5 contains one bitmap. The Visibility register controls the bitmap. The bitmap is made invisible when I1 is actuated.

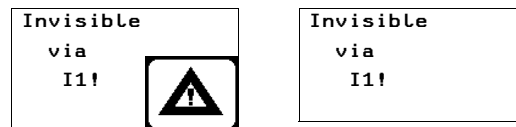
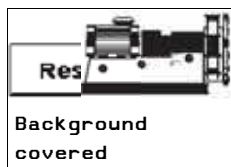

Figure 246: Make invisible

Screen 6 contains only one bitmap. The Invert Bitmap Display box is activated on the Display register. The associated variable I2 is defined for making the bitmap visible (N/C bit logic) on the Visibility register. The bitmap is then inverted by actuating I2.



Screen 7 contains two bitmaps. "Background covered" is selected for both bitmaps on the "Display" register. As the right bitmap covers the left one, the right bitmap is fully displayed.

6 Visualization with MFD-Titan

6.4 Screen Editor

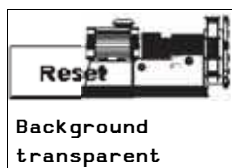

Screen 8 contains two bitmaps. The right one covers the left bitmap. However, both bitmaps are displayed completely since the background of the right bitmap is set to transparent on the "Display" register.

Bitmap_Prog_02.e60 (Bit display with automatic screen change)

The program is a copy of the program `Bitmap_Prog_01.e60`, the individual screens are displayed automatically in succession.

The circuit diagram contains a pulse generator T01 which triggers output Q3 (display of pulse signal) as well as meter C01. This operation is implemented in a continuous loop as the meter triggers the timing relay T02 when it reaches its upper switch value SH. This resets the meter C01 after the set time. The corresponding counter values activate the individual screens.

Bitmap_Prog_03.e60 (Covering of bitmaps)

The program consists of three screens that you can select via cursor buttons \wedge and \vee . The screen change was defined in the button editor (→ Section "6.6 Button Editor", page 417).

This program illustrates the covering of bitmaps in a screen. The circuit diagram uses six on delayed timing relays (T01 to T06) that activate outputs Q1 to Q4 as well as LED 3 in succession after the elapsed time. The operation is carried out in a continuous loop since the timing relay T06 resets all timing relays after the set time.

Screen 1 contains five bitmaps that half cover each other. These are triggered in succession via the outputs Q1 to Q4 and marker M01 to appear in the display. The half covered bitmaps are activated in succession. The Covered option is selected in the Background area of the Display register. This therefore causes the covered section of the next bitmap behind to be displayed. It produces the effect of a moving arrow.

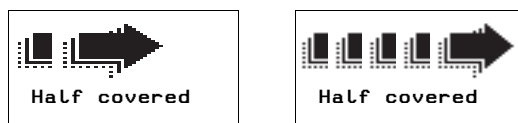

Figure 247: Covered bitmaps

Screen 2 contains five bitmaps positioned on top of each other with each bitmap displayed being larger than the one displayed beforehand. The individual bitmaps are made visible in succession via the outputs Q1 to Q4 and the marker M01 (N/C bit logic). The Covered option is selected in the Background area of the Display register. This therefore causes the covered section of the next bitmap behind to be displayed. It produces the effect of a moving arrow that increases in size.

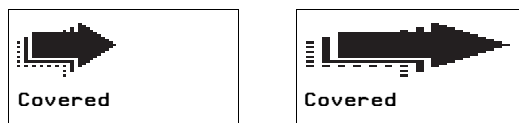

Figure 248: Arrow increasing in size

Screen 3 contains five bitmaps that completely cover each other. These are made invisible in succession from the top to the bottom via outputs Q1 to Q4 and LED 3 (N/O contact bit logic). The Covered option is selected in the Background area of the Display register. The covered part of the bitmaps cannot therefore be seen.

The first bitmap on the lowest level is always active. Thus it is always visible unless one of the other bitmaps is activated. This produces a small continuous animation.

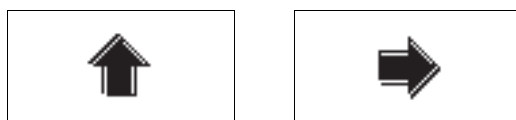

Figure 249: Rotating arrows

The following section describes the value display elements.

6.4.12 Message Bitmap

This screen display element allows you to display bitmap graphics in alternation. The status of the variable associated with a message bitmap determines which bitmap graphic is shown.

The screen display element is therefore used to indicate status changes in the process.

All bitmaps within a screen display element have the same size and always appear in the same screen position in turn depending on the state of the variable. This provides the operator with a clear and easily recognisable indication about the current process state.

Programming in easySoft-Pro

"Associated variable" tab:

- ▶ First select the Variable Type.

In the "Variable Type" area select the type bit, byte, word or double word in order to define the value range of the associated variable.

- ▶ Then choose at Associate via: the operand to be used as the set variable in order to display the various bitmap graphics.

Message bitmap table tab: In the table that opens assign each variable status value to be indicated with the message bitmap required to indicate it.

- ▶ Message bitmap table tab: In the table that opens assign each variable status value to be indicated with the message bitmap required to indicate it.

6 Visualization with MFD-Titan

6.4 Screen Editor

The entered status values must be unique and must only be used by you once.

- ▶ In the Default bitmap area, define a bitmap that is always to be output if the variable takes on a value for which a bitmap is not assigned in the table.

Display tab:

A Boolean variable can be used to change the display of a screen display element from normal to flashing. The flashing display starts if the associated variable is true. If an association is not entered, the screen display element will stay normal.

- ▶ If required choose a Boolean variable for the flashing display.

Visibility register → Section "6.4.2.3 General tabs for parameterizing a screen element", page 372.

Example application:

The example program MFD-Titan-CP8.e60 contains in the German screen Funktion_DE_Meldungsbitmap and in the English screen Function_EN_Message_bitmap the Message bitmap indication element.

The MFD-Titan-CP10.e60 example program contains the indication element in the multi-lingual screen Function_Message_bitmap.

Four different bitmap graphics are shown depending on the status of the variable MW02.

6.4.13 Bar Graph

The bar graph screen display element enables you to display analog and numerical process values graphically.

The status value of the associated variable causes the bar graph to be shown as a changing black bar on the display. The bar graph can be scaled as required, and left, right, up down can be defined as the display direction of the bar graph.

Definable upper and lower limit values enable the bar graph to flash in the event of out-of-range values and thus support increased safety in process control.

Programming in easySoft-Pro

Element specific tabs - Associated variable tab:

- ▶ First select here the Variable Type.

In the "Variable Type" area select the type bit, byte, word or double word in order to define the value range of the associated variable.

- ▶ Then choose at Associate via: the variable that is to supply the process value for displaying the variable black bars in the display.

Element specific tabs - Value range tab:

- ▶ Define a Value Range for the process value.

"Value range" area

The displayable range of the associated variable can be limited by defining the Value Range. Minimum and maximum values are the limits in which the bar can move.

- ▶ Limit the displayable range using the [min] and [max] parameters.

Zero point of bar graph area: You can move the start position of the bar by defining a zero point which the device forms as the sum of the minimum value and the zero point. This can also move in the screen display element in the opposite direction.

Zero point of bar graph area: You can move the start position of the bar by defining a zero point which the device forms as the sum of the minimum value and the zero point. This can also move in the screen display element in the opposite direction.

- ▶ Enter a value for the zero point that is within the limits of the defined value range.

Visibility register: → Section "6.4.2.3 General tabs for parameterizing a screen element", page 372.

"Display" tab:

- ▶ Define the display format of the element, e.g. flashing, as well as with or without frame, scale and limit value marks.

In order to visually indicate limit violations or another event, activate the Bar graph flashing option. This opens the additional Display change tab (Internal Limit Value Comparison or External Trigger).

- ▶ In the Detection via area select whether the display change is to be initiated by Internal limit value comparison or by an External trigger.

Detection via internal limit value comparison:

- ▶ With internal limit value comparison select at Associate via: the variable that defines the upper or lower limit value to be compared with the process value.

The bar graph will flash if the limit value is undershot or overshot.

Detection via external trigger input:

- ▶ Alternatively with the external trigger input select at Associate via: the Boolean variable that is to initiate a display change.

Example application:

The example program MFD-Titan-CP8.e60 contains in the German screen Funktion_DE_Bargraph and in the English screen Function_EN_Bar_graph the Bargraph indication element.

6 Visualization with MFD-Titan

6.4 Screen Editor

The MFD-Titan-CP10.e60 example program contains the screen display element in the multi-lingual screen `Function_Bar_graph`.

The two horizontal bar graphs show the value of the analog inputs IA 1/2, the vertical bar graph shows the value of MW07.

6.4.14 Date and Time Display

This screen display element shows the date and time of the MFD real-time clock on the display. International display formats are available for selection according to the easy system languages, as well as US display formats.

The height of the element frame depends on the font size. Three sizes are possible:

- Normal font,
- Double font size and
- Fourfold font size

Programming in easySoft-Pro

Date formats tab:

- ▶ In the Country settings list choose the language in order to define the arrangement of day, year and month and in the Format list box a combination of date time and weekday display.

The different display formats are shown in the table in the easySoft-Pro Help system.

"Visibility and Display change" tabs: → Section "6.4.2.3 General tabs for parameterizing a screen element", page 372.

Application examples 1:

The example program MFD-Titan-CP8.e60 contains in the German screens `Funktion_DE_Datum/Zeit` and `Funktion_DE_Datum/Zeit_2` as well as in the English screens `Function_EN_Date_a_time_display` and `Function_EN_Date_a_time_displ_2` the Date and time display screen element.

The example program MFD-Titan-CP10.e60 contains the Date and time indication elements in the multi-lingual screens `Function_Date_a_time_display` and `Function_Date_a_time_displ_2`.

Application examples 2:

The example programs `Date_a_Time_Prog_01.e60` to `Date_a_Time_Prog_03.e60` show other applications of this screen element. The example applications 2 are based on the MFD-CP8... and do not include the improved language selection of the MFD-CP10....

Date_a_Time_Prog_01.e60 (different display types and invisible switching of a screen)

The program consists of eight screens that you can select via cursor buttons \wedge and \vee . The screen change was defined in the button editor (\rightarrow Section "6.6 Button Editor", page 417).

The first six screens show the options for date and time display, the seventh screen shows all four formats simultaneously and invisible switching is implemented with the eighth screen.

Screen 1: Display size doubled, therefore only day and month visible in display! Format: DD.MM:YYYY

Screen 2: Normal display size, therefore year display also visible! Format: DD.MM.YYYY

Screen 3: Normal display size, also display of time in hours and minutes. Format: DD.MM.YY HH:MM

Screen 4: Display size of hour and minute doubled. Format: HH:MM

Screen 5: Display of weekday and date in normal size. Format: WD DD.MM.YY

Screen 6: Display of hour and minute, single display format. Format: HH:MM

Screen 7: Display of different formats in one screen. Display in normal size.

Screen 8: Display invisible, if I1 actuated. (N/O contact bit logic!)

WE 03.10.01

Invisible
via I1!
2003-10-01

Date_a_Time_Prog_02.e60 (different display types with automatic screen change)

This program is a copy of the program Date_a_Time_Prog_01.e60 except that the screen change is automatic. The program consists of eight screens that are triggered in succession by meter C01. The pulses for activating the screens are supplied by timing relay T01. This produces counter values 0 to 9. Counter value 1 activates screen 1, counter value 2 screen 2 etc. The meter resets itself when the upper limit value SH = 9. This produces a continuous loop. "German" is the language setting in all eight screens.

Date_a_Time_Prog_03.e60 (different country settings)

The program consists of 11 screens that are triggered automatically by meter C01. The pulses for activating the screens are supplied by timing relay T01. This produces meter values 0 to 12. Meter value 1 activates screen 1, counter value 2 screen 2 etc. The meter resets itself when the upper limit value SH = 12. This produces a continuous loop.

Each screen contains a different country setting. However the same format "WD DD MM YY" is shown.

6 Visualization with MFD-Titan

6.4 Screen Editor

Screen 4

```
Country
setting
Spanish
MI 01/10/03
```

Screen 7

```
Country
setting
Portuguese
QU 01-10-03
```

Date display with different country settings

6.4.15 Numerical value

This screen display element enables you to display signal states directly or scaled in decimal format.

Value and scaling range

The value range determines the range of values to be displayed. The MFD indicates an underflow if the values are below this range and an overflow if they are above it.

The scaling range enables the value range to be scaled. To do this, the lower value of the scaling range is assigned to the lower value of the value range and the upper value of the scaling range is assigned to the upper value of the value range. If no scaling range is defined, the MFD displays the value range.

Examples

If you wish to display the value range (0 to 255) for example from a counter as a percentage (0 to 100%), then enter 0 as the minimum value and 255 as the maximum value in the Value range area. Enter “%” as a unit of measure. Activate the Scaling range area and enter 0 as the minimum value and 100 as the maximum value.

If you wish to display the value range from 0 to 120 seconds, for example, from a timing relay in minutes (0 to 2 min), enter 0 as the minimum value and 120 as maximum value in the Value range area. Enter “min” as a unit of measure. Activate the Scaling range area and enter 0 as the minimum value and 120 as the maximum value.

Programming in easySoft-Pro

"Associated variable" tab:

- ▶ Choose the Boolean variable for activating the numerical value.

Number range/format tab:

- ▶ Make the following settings here:
 - Value range.
 - Unit of measure.
 - Scaling Range.
 - Display change.
 - if necessary, force the display of a sign.

Visibility register: → Section "6.4.2.3 General tabs for parameterizing a screen element", page 372.

Application examples 1:

The example program MFD-Titan-CP8.e60 contains in the German screens Funktion_DE_Zahlenwert and Funktion_DE_Zahlenwert_2 as well as in the English screens Function_EN_Numeric_value and Function_EN_Numeric_value_2 the Numerical value display element.

The MFD-Titan-CP10.e60 example program contains the Numerical value display element in the multi-lingual screen Function_Numeric_value and Function_Numeric_value_2.

Application examples 2:

The following Numericalvalue_Prog_01.e60 example program shows other applications of this screen element.

Numericalvalue_Prog_01.e60 (numerical value)

The program consists of ten screens that you can select via cursor buttons ^ and v. The screen change was defined in the button editor (→ Section "6.6 Button Editor", page 417).

Screen 1 shows six simple output formats for the numerical values and shows an overview of the properties provided in the Number range/format tab. The first screen shows six numerical values. These are all linked with the on-delayed timing relay T04 (Associated variable tab) for which a time range of 4 seconds is set. The actual value of the timing relay is provided at its QV output (FB parameter) and is then displayed in the appropriate number format. The variable type of the associated variable is Dword.

Table 34: Numerical values and output formats

Left column	Right column
Numerical value 1 • Value range: 0 to 50 000 • Unit: None • Scaling Range: None • Always Show Sign: No	Numerical value 1 • Value range: 0 to 4 000 • Unit: None • Scaling Range: 0 to 4 • Decimal Places: 0 • Always Show Sign: No
Numerical value 2 • Value range: 0 to 50 000 • Unit: ms • Scaling Range: None • Always Show Sign: No	Numerical value 2 • Value range: 0 to 4 000 • Unit: s • Scaling Range: 0 to 4 • Decimal places: 1 • Always Show Sign: No
Numerical value 3 • Value range: 0 to 50 000 • Unit: ms • Scaling Range: None • Always Show Sign: Yes	Numerical value 3 • Value range: 0 to 4 000 • Unit: s • Scaling Range: 0 to 4 • Decimal Places: 2 • Always Show Sign: Yes

6 Visualization with MFD-Titan

6.4 Screen Editor

Timer 4	
1873	2
1873ms	1.9s
+1873ms	+1.87s

Figure 250: Output formats

Screen 2 shows a simple example of the visualisation of timing relay times using the function block parameter (FB parameter) from the Associated variable register. This screen contains three numerical values. These are all associated with the QV output of the timing relay T04.

Table 35: Numerical value - visualisation of timing relay times

Numerical value 1:	Start value of the timing relay T04 FB parameter: I2 (zero, as input I2 is not assigned for an on delayed relay!)
Numerical value 2:	Set value of the timing relay T04 FB parameter: I1 (4000, as input I1 is assigned with the constant 4 s (= 4000 ms) in the function block editor)
Numerical value 3:	Actual value of timing relay T04 FB parameter: QV (display of the value present at the function block output)

To interpret the displayed values, "ms" (milliseconds) is entered in the Unit of Measure area on the Number range/format register.

Start value	0ms
Setpoint	

Figure 251: Timing relay times

Screen 3 shows an example of the output of analog values (here IA3) on the display. Note the Scaling Range area on the Number range/format register.

This screen contains three numerical values that output the analog value in different formats. The values are associated via analog input IA3 (Associated variable register) which provides a value as variable type DWord on the QV output (FB parameter) for further processing.

All numerical values have a value range between 0 and 1019 since this scanning range is defined by the connected potentiometer.

Table 36: Numerical value - Analog value output

Numerical value 1:	Display of the analog value (0 to 1019)
Numerical value 2:	Display of the analog value with the scaling range 0 to 10, two decimal places, unit of measure "V" (Volt)
Numerical value 3:	Display of the analog value with the scaling range -5 to +5, two decimal places, unit of measure "V" (Volt), signed

Analog input	I3
Scale value	358
0to10	3.51V
-5to+5	-1.49V

Figure 252: Analog value output

Screen 4 shows an example of the output of analog values (here IA3) on the display and is an expansion of screen 3. To keep it simple all the basic settings of the scaling range from screen 3 were used.

Note the Numerical display group in the Display change area on the Number range/format register.

Table 37: Numerical value - Analog value output

Numerical value 1:	Display of the analog value (0 to 1019)
Numerical value 2:	Display of the analog value with the scaling range 0 to 10, two decimal places, unit of measure V (Volt), always show sign: yes, display change - Detection via internal limit value comparison, numerical value display flashing
Numerical value 3:	Display of the analog value with the scaling range -5 to +5, two decimal places, unit of measure V (Volt), always show sign: no, display change - Detection via internal limit value comparison, numerical value display inverse

Analog input	I3
Scale value	0
Flashing	+0.00V
Inverted	-5.00V

Figure 253: Extended analog value output

Screen 5 shows an example of the output of analog values (here IA3) on the display with the possibility of making them invisible via I1 and I2. The settings for this were defined on the Visibility register. The screen shows two numerical values that output the analog value in different formats. These values are associated via analog input IA3 which provides a value as variable type Word for further processing.

Table 38: Numerical value - Analog value output with invisible display switch

Numerical value 1:	Display of the analog value with the scaling range 0 to 10, two decimal places, unit of measure V (Volt), hide numerical value via Boolean operand I1, N/O bit logic (Visibility tab)
Numerical value 2:	Display of the analog value with the scaling range -5 to +5, two decimal places, unit of measure V (Volt), hide numerical value via Boolean operand I2, N/O bit logic (Visibility tab)

Invisibility	
via I1	
via I2	1.29V

Figure 254: Invisible display switch

Screen 6 shows a simple example of the display change via an external trigger. In this example, input I1 represents the external trigger. This screen contains two numerical values. These are associated with the QV output of the timing relay T08 which is of variable type DWord. The timing relay is operated in a loop of 0 to 10 seconds.

6 Visualization with MFD-Titan

6.4 Screen Editor

Table 39: Numerical value - Analog value output with display change by external trigger input

General settings:	The value range from 0 to 11 000, unit of measure: s (second), scaling range from 0 to 11, two decimal places, display change active, detection via external trigger input.
Left numerical value:	Display of timing relay value T08, I1 actuated: The numerical value flashes since Display change external trigger flashing via Boolean operand I1 is set.
Right numerical value:	Display of timing relay value T08; I1 actuated: The numerical value is displayed inverted since Display change external trigger inverted via Boolean operand I1 is set

Display change (I1)
External trigger
3.37s 3.37s

Figure 255: External trigger

Screen 7 shows a simple example for the display change by means of an internal limit value comparison. The screen contains two numerical values that represent the output values (QV output) of the timing relay T08. The variable type is DWord. The timing relay is run in a loop from 0 to 10 seconds.

A value range from 0 to 11 000 is defined in the Number range/format tab. "s" (seconds) is entered as the unit of measure. The scaling range is from 0 to 11, with 2 decimal places. The display change is active and is triggered via the internal limit value comparison, causing the numerical value on the left to flash and the numerical value on the right to be displayed inverted.

Table 40: Numerical value - Analog value output with display change by internal limit value comparison

Left numerical value:	The numerical value flashes in the range from 0 to 3 and from 7 to 10. On the Display change register (internal limit value comparison), the upper limit value is 7 (the display is changed from numerical value 7 to 10) and the lower limit value is 3 (the display is changed from numerical value 0 to 3). The display is not changed in the value range from 3 to 7.
Right numerical value:	The numerical value is displayed inverted in the range from 0 to 3 and from 7 to 10. On the Display change register (internal limit value comparison), the upper limit value is 7 (the display is changed from numerical value 7 to 10) and the lower limit value is 3 (the display is changed from numerical value 0 to 3). The display is not changed in the value range from 3 to 7.

No display change

Display change (without 3-7s)
Internal trigger
6.57s 6.57s

Display change

Display change (without 3-7s)
Internal trigger
0.95 0.95s

Figure 256: Display change via internal limit value comparison

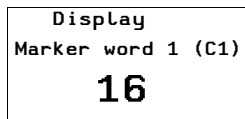

Screen 8 shows an example of the output of a marker word. The numerical value in the screen is associated with the marker word MW01. The variable type Word.

A value range from 0 to 999 is set in the Number range/format tab. The timing relay T09 switches meter C01 every two seconds (→ circuit diagram in easySoft-Pro). The counter function block output QV writes the data to marker word MW01 (set in the Function block output area of the Parameters tab). The meter is reset if the upper switch value SH (38) is reached.



In easySoft-Pro the contents of the markers can be displayed both in decimal and in hexadecimal format. Only decimal format is possible on the display!

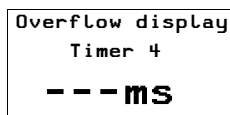

Screen 9 shows an example of a value overflow display. The associated variable is the QV output of the timing relay T04. The variable type is double word. The timing relay runs from 0 to 4000 ms. Only a value range from 0 to 3000 and the measuring unit "ms" are defined on the Number range/format register. This will cause a value overflow as soon as 3000 ms is exceeded. This is indicated in the display by an overflow display.

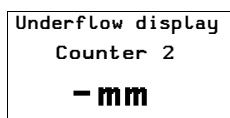

Screen 10 shows an example of a value underflow display. The associated variable is the QV output of the counter C02. The variable type is DWord. The counter C02 is activated by timing relay T07 with Flashing mode selected. The counter runs down from 12 to 0. Only a value range of 6 to 12 and a unit of measure "mm" is defined on the Number range/format register. This causes a value underflow as soon the value goes below 6 mm. This is indicated in the display by an underflow display.

6.4.16 Timing Relay Value Display

This screen display element is used to show the process value of an associated variable as a time.

Important! For this the program must contain a timing relay function block.

Programming in easySoft-Pro

"Associated variable" tab:

- Choose the variable for displaying the time.

If you choose an input value (T..I1/T..I2) or the output value (T..QV) of a timing relay as the associated variable, the display format is adjusted according to the display range set for this timing relay (S, M:S or H:M).

If you select a marker double word (MD..) as the associated variable, you can set the time range for the screen display element.

6 Visualization with MFD-Titan

6.4 Screen Editor

If the process value is outside of the range of values supported by the time range, an overflow or underflow will be indicated with an arrow and the following displays **↑↓**

Visibility and Display change tabs → Section "6.4.2.3 General tabs for parameterizing a screen element", page 372.

Example application:

The example program MFD-Titan-CP8.e60 contains in the German screen Funktion_DE_Zeitrelaiswertanzeige and in the English screen Function_EN_Timing_relay_valu_displ the Timing relay value indication element.

The MFD-Titan-CP10.e60 example program contains the display element in the multi-lingual screen Function_Timing_relay_valu_displ.

The output value of timing relay T01QV is shown above it. The resolution sss.ms is automatically matched to the set time range of the timing relay.

The following section describes the value entry elements.

6.4.17 Value Entry

This screen entry element enables you to enter numerical setpoint values during operation and thus make interventions in the process. This is done by entering the signal state via the associated set variable.

The MFD stores the entered value internally. The program processes the value and displays it until it is changed by the operator or the program. Without an operator entry this screen element functions like the numerical value screen element and therefore displays the value of the associated set variable.

At the beginning of the entry on the MFD, the entry field contains the last variable value. Pressing **OK** activates Selection mode in which you can use the cursor buttons to move between the value entry elements of a screen. If the screen contains several value entry elements, the entry element first added in the screen editor (indicated by the numbering of the screen element in the status line of easySoft-Pro) is selected first.

After the required entry element was selected, you activate Entry mode by pressing **OK** again.

Use the cursor buttons to select the number(s) to be changed and change the setpoint value.

Press **OK** once more to confirm the value entry and leave Entry mode.

Value and scaling range

The value range determines the range of values to be displayed. The MFD indicates an underflow if the values are below this range and an overflow if they are above it.

The scaling range enables the value range to be scaled. To do this, the lower value of the scaling range is assigned to the lower value of the value range and the upper value of the scaling range is assigned to the upper value of the value range. If no scaling range is defined, the MFD displays the value range.

Examples

If you wish to display the value range (0 to 255) for example from a counter as a percentage (0 to 100%), then enter 0 as the minimum value and 255 as the maximum value in the Value range area. Enter “%” as a unit of measure. Activate the Scaling range area and enter 0 as the minimum value and 100 as the maximum value.

If you wish to display the value range from 0 to 120 seconds, for example, from a timing relay in minutes (0 to 2 min), enter 0 as the minimum value and 120 as maximum value in the Value range area. Enter “min” as a unit of measure. Activate the Scaling range area and enter 0 as the minimum value and 120 as the maximum value.

Programming in easySoft-Pro

Register Associated variable:

Enter here the Boolean variable for which you wish to set the value.

Number range/format tab:

You define the following in this tab:

- Value range.
- Unit of measure.
- Scaling Range.
- Input format.

The display of the sign can be forced.

Visibility and Display change tabs → Section “6.4.2.3 General tabs for parameterizing a screen element”, page 372.

Application examples 1:

The example program MFD-Titan-CP8.e60 contains in the German screen Funktion_DE_Werteingabe and in the English screen Function_EN_Value_entry the Value entry indication element.

The MFD-Titan-CP10.e60 example program contains the Value entry display element in the multi-lingual screen Function__EN_Value_entry.

Application examples 2:

The ValueEntryProg_01.e60 example program shows other applications of this screen element.

ValueEntryProg_01.e60 (value entry)

The program consists of seven screens that you can select via cursor buttons \wedge and \vee . The screen change was defined in the button editor (\rightarrow Section "6.6 Button Editor", page 417). While the MFD is in RUN state you can modify all the values that are processed by the program via the cursor buttons $\langle \rangle \wedge \vee$. The actual values are shown in the MFD's display.

In order to display values the MFD must firstly be switched to Selection mode. In Selection mode you can select the value entry element for the values you wish to change.

- ▶ Press **OK** so that the MFD switches to Selection mode. Press **ESC** to exit Selection mode.

The selected value entry element will flash. If several entry elements are present you can select the required element with the cursor buttons $\langle \rangle \wedge \vee$ (\rightarrow Screen 7).

- ▶ Press **OK** in order to switch from Selection mode to Entry mode.
- ▶ Move to the required position with the cursor buttons \langle and \rangle , change the value with the cursor buttons \wedge and \vee .
- ▶ Accept the modified value with **OK**. Pressing **ESC** will cause the previous value to be retained. In both cases you will return to Selection mode and can exit this by pressing **ESC**.

The circuit diagram contains the timing relay T01 that triggers the counter C02. The counter switches the output Q1 to high when the upper set value SH is reached. The value of the counter function block output QV is transferred to the marker word MW06. The upper set value SH is associated with the marker word MW07 and the preset actual value SV with marker word MW05. During RUN mode the current data is stored in the marker words and new data is written there via the value entry elements. Input I2 can be used to reset the counter at any time. I1 (rising edge) is used to accept the value at marker word MW05 as a new preset actual value SV. As no value is stored in marker word MW07 (switch value for Q1) when the program is started, this is interpreted as switch value "zero" and the output Q1 is immediately set to "high".

Switch value	Q1(OK)
Actual value 99	100

Screen 1 illustrates the value entry option via the set variable marker word MW 07 (switch value for Q1). The value entry element is shown enlarged on the display. A value range is defined from 0 to 9999 in the Number range/format register and Allow Digit Selection is set as entry mode. The input I01 is selected with N/O contact bit logic on the Operability tab. The value is written to the marker word 7 and transferred by counter input SH. Q1 is high when the counter input value QV equals or is greater than the upper set value SH. If the actual value is already higher than the switch value, you can reset the counter via I2. Q1 switches immediately to low and is not set again until the switch value is reached.

Screen 2 illustrates the value entry option via the set variable marker word MW05 (preset actual value SV). After you have entered a new value this is written to the marker word MW05 by actuating I1. This is associated with the preset actual value SV of the counter C02. After the transfer, the actual value QV jumps to the entered SV value and counts on from there.

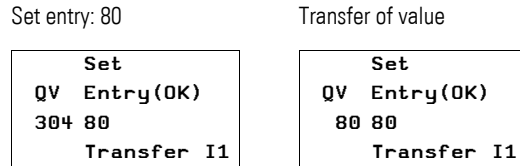

Figure 257: Transfer of value on closing of I1

Screen 3 shows an example of the Number range/format register, especially the Scaling range and Input Format r Allow Digit Selection. You can enter any value from 0.00 to 10.00 (allow digit selection). After I1 is closed, the preset actual value SV is transferred. After the transfer, the actual value QV jumps to the entered SV value and counts on from there. The maximum scaling range (10.00) is assigned to the maximum value range (9999). The QV value thus switches to the value 10.00 when 1 is entered and 9999 is actuated.

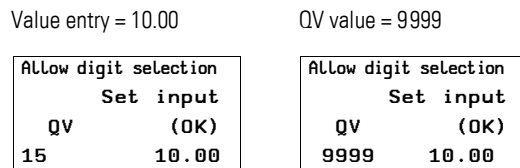

Figure 258: Transfer of value with Allow digit selection

Screen 4 shows an example of the Number range/format register, and in particular the Scaling range and Input Format r Fixed Step Width. You can enter any value from 0.00 to 10.00 in step widths of 0.50 (fixed step width). After I1 is closed, the preset actual value SV is transferred. After the transfer, the actual value QV jumps to the entered SV value and counts on from there. The maximum scaling range (10.00) is assigned to the maximum value range (9999). The QV value thus switches to the value 10.00 when 1 is entered and 9999 is actuated.

6 Visualization with MFD-Titan

6.4 Screen Editor

Value Entry		Transfer QV value	
Step Width		Step Width	
Set input		Set input	
QV	(OK)	QV	(OK)
16	8.50	8500	8.50

Figure 259: Transfer of value with Fixed Step Width

Screen 5 shows an example from the Visibility tab. If I4 is closed, the value entry element is made invisible. The N/O contact bit logic is set. If N/C contact bit logic was set, this would create a visible switch function. The element remains operable even when invisible, and value entry is still possible.

Set value visible		Set value invisible	
Set value entry		Set value entry	
invisible		invisible	
QV	via I4	QV	via I4
299	1037	299	

Figure 260: Switch value entry element invisible

Screen 6 shows an example using the Operability tab. The same Visibility setting is used as in screen 5. Closing I3 will disable the entry function (N/O contact bit logic). If the value entry element is disabled, you can still select it (it flashes) but the Entry mode (change values) is disabled. If the value entry element is in Entry mode when I3 is closed, the MFD switches automatically to Selection mode. If N/C contact is set as bit logic, entry is only possible if I3 is actuated. I4 switches the value entry element to invisible, however, it still remains operable allowing values to be changed.

I3 not actuated		I3 actuated	
Set value entry		Set value entry	
Blocked		Blocked	
QV	via I3	QV	via I3
249	1037	249	1037

Figure 261: Value entry element disabled

6.4.18 Timing relay value entry

This screen entry element enables to make a later change to the time setpoints at inputs I1 and I2 of the timing relay function block (T ..). A constant (NU) must be set at the input to be changed.

Requirement for using the screen entry element: The program must already contain the timing relay function block. The input T ..I1 or T ..I2 to be assigned parameters must be set with a constant (NU). Inputs without assigned parameters cannot be edited via this screen entry element.

The display format is adjusted to the timing range set for this timing relay (S, M:S, H:M).

Programming in easySoft-Pro

"Associated variable" tab:

- ▶ Choose here in the Number list box the function block T 01...32 to be changed and in the FB Parameters list box the input T ..I1 or T ..I2 to be changed.

Visibility and Display change tabs → Section "6.4.2.3 General tabs for parameterizing a screen element", page 372.

Example application:

The example program MFD-Titan-CP8.e60 contains in the German screen Funktion_DE_Zeitrelaiswerteingabe and in the English screen Function_EN_Timing_relay_valu_en the Timing relay value entry element.

The MFD-Titan-CP10.e60 example program contains the screen entry element in the multi-lingual screen Function_Timing_relay_valu_entry.

The input value I2 of the timing relay T02 is set via this entry element. The resolution sss.ms is automatically matched to the set time range of the timing relay.

6 Visualization with MFD-Titan

6.4 Screen Editor

6.4.19 Date and time entry

This screen element can be used to change the date and time of the device real-time clock. If the device is in RUN operating state, the operator can carry out these changes with the buttons of the MFD.

The entry element is shown on the screen in a Normal font size, i.e. with a simple font size with up to 16 characters per line.

Programming in easySoft-Pro

Element specific tabs - Date formats tab:

- ▶ In the Country settings list choose the language in order to define the arrangement of day, year and month.

The time is shown in the format hh:mm.

The different country settings are shown in the table in the easySoft-Pro Help system.

"Synchronize Date and Time via NET" check box:

When this option is active, the local date and time change via this screen entry element are transferred to the device real-time clocks on all NET stations. These are synchronized with the modified value.

The option has the same effect as the SC01 (Send Clock) function block, which sets the date and time of all stations on the NET to the same value.

Visibility and Operability register: → Section "6.4.2.3 General tabs for parameterizing a screen element", page 372.

Example application:

The example program MFD-Titan-CP8.e60 contains in the German screen Funktion_DE_Datum/Zeiteingabe and in the English screen Function_EN_Date_a._time_entry the Date and time entry element.

The MFD-Titan-CP10.e60 example program contains the screen entry element in the multi-lingual screen Function_Date_a._time_entry.

6.4.20 Weekly timer inputs

This screen entry element enables you to make later changes to the on or off times for one of the four channels (A, B, C and D) of the weekly timer function block (HW ..). In order to change the parameter set of a channel (on and off) completely, you therefore require two of these screen entry elements.

If the device is in RUN operating state, the operator can make the changes via the pushbuttons of the MFD. He can change the weekday (DY.), hour and minute of the on and off time. The new value entered is permanently stored in the program.

Requirement for using the screen entry element:

The weekly timer function block is already incorporated in the program and the channel to be modified has already been assigned parameters. Channels that have not been assigned parameters cannot be modified!

Programming in easySoft-Pro

Associated variable tab:

- ▶ Choose here in the Number list box the function block HW 01...32 to be changed and in the FB Parameters list box the channel A...D to be changed.

The channel A...D to be changed must be set in the program.

- ▶ In the Time On/Off area use the ON or OFF option buttons to define whether the on or off time of the selected channel can be changed via this screen entry element.

Selecting the ON option activates the channel parameters DY1 and ON of the assigned weekly time clock.

Selecting OFF activates the channel parameters DY2 and OFF.

- ▶ If required use the Country settings list box to change the display format of weekday, hour and minute of the on and off time in the screen element.

Visibility and Display change tabs → Section "6.4.2.3 General tabs for parameterizing a screen element", page 372.

Example application:

The example programs MFD-Titan-CP10.e60 and MFD-Titan-CP8.e60 contain the Weekly timer entry element.

When the Function_7-day_time_switch_entry or Funktion_DE_Wochenzeitschaltuhr screens are displayed with the **ON** option active, the ON time of function block HW01, channel A can be changed during the run time. The Function_7-day_time_switch_ent_2 or Funktion_DE_Wochenzeitschaltuhr_2 screens with the **OFF** option active enable the OFF time of HW01, channel A to be changed.

6 Visualization with MFD-Titan

6.4 Screen Editor

6.4.21 Year time switch entry

The screen element allows you to make later changes to the on and off time for each of the four channels (A, B, C and D) of the year time switch (HY) function block. In order to change the parameter set of a channel (on and off) completely, you therefore require two of these screen entry elements.

If the device is in RUN operating state, the operator can make the changes via the pushbuttons of the MFD. Here he can change the day (DD), month (MM) and year (YY) of the on and off time.

The new value entered is permanently stored in the program.

Requirement for using the screen entry element:

The year time switch function block must be already incorporated in the program and the channel to be modified must have already assigned parameters. Channels that have not been assigned parameters cannot be modified.

Programming in easySoft-Pro

"Associated variable" tab:

- ▶ Choose here in the Number list box the function block HW 01...32 to be changed and in the FB Parameters list box the channel A...D to be changed.



If only dashes --:-- are shown in the date format even though the screen entry element is large enough, this means that the program does not contain an HY .. function block for the selected operand number.

- ▶ In the Time On/Off area use the ON or OFF option buttons to define whether the on or off time of the selected channel can be changed via this screen entry element.

By selecting ON mode, the channel parameters day (DD), month (MM) and year (YY) are activated for changing the on time of the assigned year time switch.

Selecting OFF activates the same channel parameters for changing the off time.

- ▶ If required use the Country settings list box to change the display format of weekday, hour and minute of the on and off time in the screen element.

Visibility and Display change tabs → Section "6.4.2.3 General tabs for parameterizing a screen element", page 372.

Example application:

The MFD-Titan-CP10.e60 and MFD-Titan-CP8.e60 example programs contain screens with the Year time switch entry element.

When the Function_Year_time_switch_entry or Funktion_DE_Jahreszeitschaltuhr screens are displayed with the **ON** option active, the ON time of function block HY01, channel A can be changed during the runtime. The Function_Year_time_switch_ent_2 or Funktion_DE_Jahreszeitschaltuhr_2 screens with the **OFF** option active enable the OFF time of HY01, channel A to be changed.

6 Visualization with MFD-Titan

6.5 Button operation on the MFD-Titan

6.5 Button operation on the MFD-Titan

The following table shows the function of the MFD function keys in the visualization. Pressing the * pushbutton switches you from the Status display to the visualization.

Table 41: Function of the function keys in the visualization of the MFD

Cursor up	Without function (can be overwritten with button element)
Cursor down	Without function (can be overwritten with button element)
Cursor left	Without function (can be overwritten with button element)
Cursor right	Without function (can be overwritten with button element)
OK	Move from the visualization to the Selection mode (can be overwritten with button element)
DEL	Without function (can be overwritten with button element)
ESC	Without function (can be overwritten with button element)
ALT	Without function (can be overwritten with button element)
* -Pushbutton	Move from the visualization back to the Status display (can be overwritten with button element)
ALT + DEL	Without function

6.5.1 Operating principle in the visualization

In RUN mode the operator can use the cursor buttons in the visualization to enter a variable or a setpoint value. For this the cursor buttons have basic functions if new functions were not assigned using the button element:

- Move (Selection mode).
- Enter (Entry mode).

The current mode is indicated by the appearance of the flashing cursor.

Both modes can be closed again by pressing the ESC button.

6.5.1.1 Selection mode in the visualization

Requirement: The visualization must show a screen that contains at least one screen entry element.

- ▶ As an operator you press the OK button in the visualization in order to activate Selection mode.

The screen entry element is shown as an inverse flashing rectangle. If the screen contains several entry elements, the element that was edited first is always selected.

- ▶ In Selection mode use the <> ^ v buttons to position the cursor on a screen entry element if the screen contains several of them.
- ▶ Then press the OK button to move from Selection mode to Entry mode. Values can only be entered or modified in Entry mode.

6.5.1.2 Entry mode in the visualization

The selected digit or entry location in a screen entry element is always displayed flashing. With a screen menu entry element, the name of the first selectable screen flashes.

- ▶ Position the cursor with the < > buttons on the entry location and use the ^ v buttons to select the value.
- ▶ Accept the entered or modified value with OK.
- ▶ Now exit the active Selection mode with ESC.
- ▶ With screen menu entry elements use the cursor buttons to scroll to the required screen indicated by its name.
- ▶ Press OK to enter this screen directly.

6.6 Button Editor

For fast access to the visualization elements and variables you can assign new functions to the pushbuttons of the MFD. For this you can create a macro for each operator pushbutton by assigning several functions consecutively.

The modified button function can be used during the visualization. If you return the MFD to the Status display, the basic functions of function key are restored.

You use button elements in the button editor to assign new button functions to the operator buttons.

The Button editor provides the following button elements, and the list below shows in round brackets the device version number of an MFD-CP8 from which this is possible:

Information in square brackets indicates the operating system [OS-] version number of an MFD-CP10..., from which the button element can only be used for these devices.

Button element	→ Page
Operable Screen Element (1)	419
Display Backlight (1)	419
Display contrast [CP10, OS-Ver. 1]	420.
Screen Change (1)	369
Password Logout (1)	434
Set Variable to Fixed Value (1)	422
Decrement Variable (1)	423
Increment Variable (1)	424
Changeover Relay (1)	426
Disable Change to Status Display (5)	426
P Button Function (5)	427
Go to Previous Screen (5)	428

6 Visualization with MFD-Titan

6.6 Button Editor

Button element	→ Page
Disable Selection Mode (5)	429
Jump Label (5)	429
Conditional Jump (5)	430



The button assignment is screen-oriented. Functions can therefore be assigned to operator buttons for any particular screen.

This feature is then very useful if, for example, you create several screens for your visualization application and you want the operator to be able to move between them by pressing a particular button.

6.6.1 How to Assign a Pushbutton Element to a Pushbutton

Prerequisites

- The screen in which the new button function is to be defined must be selected in Visualization view.
- The button editor must be opened.
- The operator button to be assigned the new function must be selected e.g. DEL.



Figure 262: Preselected DEL pushbutton that can be assigned with pushbutton elements

- ▶ Drag a button element, e.g. Set variable to fixed value and drop it into the Button functions list underneath the symbolized buttons in the Workbench window.

You can drag several button elements to the Button functions list (up to 255) and thus assign them to an operator button. This for example enables you to assign several variables to one fixed value with one button actuation.

- ▶ Associate the button element with the suitable operand, e.g. MW4 and complete the parameterization, for example, with the set value 4711.
- ▶ If you then press the DEL pushbutton in the visualization, MW4 is set to the value 4711.

6.6.1.1 Deleting a button element

In easySoft-Pro you delete a pushbutton element from the Button functions list with the Del pushbutton.

The following shows a function description of the button elements. Refer to the easySoft-Pro Help for information on how to assign these with parameters.

6.6.2 Select operable screen element

The Select operable screen element function enables the user to reach a value entry element directly, e.g. in the Value entry screen element, (→ section "6.4.17 Value Entry", page 406). The Entry mode required is activated automatically.

Programming in easySoft-Pro - parameterization

- ▶ In the "Screen" list box: select the screen with the required value entry element.
- ▶ In the "Value entry screen element": select the required value entry element - indicated by the number of the screen element in the easySoft-Pro status line - if the screen contains several of these elements.

This completes the parameterization.

Button element during operation

During operation the user:

- selects the button element with the assigned function key
- uses the cursor buttons to select the digit(s) to be changed and the new setpoint value.
- uses **OK** to confirm the value entry and exit Entry mode.

6.6.3 Display Backlight

The display backlight function enables the operator to set the display backlight brighter in 25% stages between 0%-100 %, or with a different parameter setting from 100%-0%. Another pushbutton is required to adjust the display backlight in the opposite direction.

6.6.3.1 Changing the display backlight via LE1

You can use the LE1 output operand to change the backlight for the display and the front plate buttons of the MFD in RUN operating state.

The cyclical setting and resetting of the LE1 output operand in the circuit diagram can be used, for example, to implement flash functions.

6 Visualization with MFD-Titan

6.6 Button Editor

Table 42: Changing the backlight via LE1

Status of LE1	Backlight
0	switched on, according to the brightness level set in the MFD System menu
1	Switched off

Programming in easySoft-Pro - parameterization

- ▶ Under Gradual display adjustment set the required brighter or darker setting.

6.6.4 Display contrast

Available on MFD-CP10....

The Display contrast function enables the operator to set the display contrast higher or lower during operation with the assigned operator button. Another button assigned to the Display contrast function is required to adjust the display contrast in the opposite direction.

Programming in easySoft-Pro - parameterization

- ▶ Under Gradual display adjustment set the required brighter or darker setting.

6.6.5 Screen change

This function enables the operator to switch between several screens. To do this you must assign the Screen change function to an operator button in each screen.



The "Screen Change" function is a closing function. The current screen is closed after this function has been executed and so no other operations are possible in it.

This means that this function should always be the last function in the Button functions list when a button is assigned functions. This must also be taken into account when later reversing the order with the Up / Down buttons.

Programming in easySoft-Pro

In addition to the above requirement, the use of this button element requires at least two screens between which the function is toggled.

Parameter definition

- ▶ In the Screen: field select the required target screen.

This completes the parameterization.

6.6.6 Password logout

The "Password logout" function is used by the operator to cancel the access rights granted for a protected screen after the password is entered. The password entry window is then displayed. In this way, the next operator then has to enter a valid password in order to display the screen.

Programming in easySoft-Pro

Besides the above requirements for using the button element you must have edited at least one password with a logout time for a screen with a value entry element.

Parameter definition

- ▶ In the Logout of area click the check box for the password that will lose its access rights after the assigned pushbutton is pressed. This completes the parameterization.

Example

Requirements:

- A password with a logout time of 30 minutes was entered for screen 2.
- Screen 2 contains a value entry element.
- The Password logout function was assigned to the < pushbutton.

During operation: You can access Screen 2 after entering the password. You then have 30 minutes to enter or change a value without a password request being output. If you decide after 5 minutes that the value no longer has to be changed and leave your workplace, it may be possible that an unauthorized person changes the value in the remaining 25 minutes. To prevent this you can reset the logout time using the < button. A new password request is generated. The operator then has 2 options:

- Re-enter the password so that the screen is displayed again.
- Press ESC to move to another screen.

On MFD-CP8... devices up to device version number 04 the display of the current screen is continued instead of the displaying the password entry window. The operator must re-enter the password before he can start a value entry or actuate an operator button assigned with functions.

If you have also added other functions in addition to the password logout to the "Button functions" list which the MFD is required to execute automatically in succession, these other functions are also processed after the password logout is completed.

6 Visualization with MFD-Titan

6.6 Button Editor

When moving to a password protected screen using the "Screen Change" function, the MFD will show the password entry window. To display the screen you must enter the correct password.

On MFD-CP8... devices up to device version number 04 the new screen is displayed immediately for the "Screen Change" function. You only have to enter the password if you wish to make a value entry or actuate an function key that is assigned functions.

If at another time an operator access authorization is achieved by entering an alternative password, the actuation of this button will not end this logout time.

6.6.7 Set variable to fixed value

This function enables the user during operation to set the value of the assigned operand with the specified value by pressing a button.

Possible operands

Boolean operands (bit variable type):

- LE
- M
- Q
- S
- Function block inputs; the button element acts on the input like the contact of contactor.

CAUTION

Ensure that the Boolean operand or function block input used here is not being accessed at the same time by the circuit diagram. These operands must not therefore be used again in a coil field.

In the event of dual access, the operand always takes on the state of the last completed access. The button actuation of the operator may therefore be immediately undone by the circuit diagram.

Byte and multiple byte operands

- Byte variable type: MB 01 - 96
- Word variable type: MW 01 - 96 and analog output QA
- DWord variable type: MD 01 - 96 and function block inputs (setpoints).



From MFD-CP8... devices with device version number 05 and MFD-CP10... devices, the setpoint value on a function block input can be set to a fixed value.

Only the function block inputs (DWord variable type) that are associated with a constant (NU) can be set to a fixed value.

Function

During operation the new value is accepted by the device by pressing the assigned button and is retained until it is overwritten or until the device is switched off.

The following operands also retain the value after the device is switched back on:

- function block inputs that are associated with a constant (NU).
- retentive markers (M., MB., MW., MD..).

Programming in easySoft-Pro - parameterization

- ▶ First select the type (bit, byte, word, Dword) of the set variable to be changed in the Variable type area.
- ▶ In the Variable to be set area, select the set variable which is to be set to the specified value by button actuation.
- ▶ Finally enter the value in the Set variable with area with which the variable is to be set.

This completes the parameterization.

6.6.8 Decrement Variable

This function enables the user during operation to reduce the value of the assigned operand by the specified value by pressing a button.

Possible operands

Byte and multiple byte operands

- Byte variable type: MB 01 - 96,
- Word variable type: MW 01 - 96 and analog output QA,
- DWord variable type: MD 01 - 96 and function block inputs (setpoints).



The setpoint value on a function block input can be decremented on MFD-CP8... devices with device version number 05 or higher and MFD-CP10... devices.

Only the function block inputs (DWord variable type) that are associated with a constant (NU) can be decremented.

6 Visualization with MFD-Titan

6.6 Button Editor

Function

During operation the value is decremented by pressing the assigned button and is retained until it is overwritten or until the device is switched off.

The following operands also retain the value after the device is switched back on:

- function block inputs that are associated with a constant (NU).
- retentive markers (MB., MW., MD..).

Programming in easySoft-Pro - parameterization

- ▶ First select the type (byte, word, double word) of the set variable to be changed in the Variable type area.
- ▶ In the Variable to be set area, select the set variable with the value to be decremented by button actuation.
- ▶ Finally enter in the Decrement variable area the step width by which the variable value is to be decremented.

The default value is 1. Only positive values can be selected.

This completes the parameterization.



If the operator reduces the value of the associated variable during operation by button actuation, the MFD prevents any possible undershoot of the permissible value range and works with the lower limit value.
If, for example, the Byte variable type was decremented by button actuation so that the value is less than zero, the device would operate with the value zero.

6.6.9 Increment Variable

This function enables the user during operation to increase the value of the assigned operand by the specified value by pressing a button.

Possible operands

Byte and multiple byte operands

- Byte variable type: MB 01 - 96,
- Word variable type: MW 01 - 96 and analog output QA,
- DWord variable type: MD 01 - 96 and function block inputs (setpoints).



The setpoint on a function block input can be incremented on MFD-CP8... devices with device version number 05 and higher and MFD-CP10... devices.
Only the function block inputs (DWord variable type) that are associated with a constant (NU) can be incremented.

Function

During operation the value is incremented by pressing the assigned button and is retained until it is overwritten or until the device is switched off.

The following operands also retain the value after the device is switched back on:

- function block inputs that are associated with a constant (NU).
- retentive markers (MB., MW., MD.).

Programming in easySoft-Pro - parameterization

- ▶ First select the type (byte, word, double word) of the set variable to be changed in the Variable type area.
- ▶ In the Variable to be set area, select the set variable with the value to be incremented by button actuation.
- ▶ Finally enter in the Increment variable area the step width by which the variable value is to be incremented.

The default value is 1. Only positive values can be selected.

This completes the parameterization.



If the operator increases the value of the associated variable during operation by button actuation, the MFD prevents any possible overshoot of the permissible value range and works with the upper limit value.
If, for example, the Byte variable type was incremented by button actuation so that the value is greater than 255, the device would operate with the value 255.

6.6.10 Changeover relay

The changeover relay function enables the operator to negate the state of a Boolean variable or a Boolean function block input during operation by pressing a button.

Possible operands

Boolean operands (bit variable type):

- LE
- M
- q
- S
- Function block inputs, the button element acts on the input as a coil with the contactor function.

CAUTION

Ensure that the Boolean operand or function block input used here is not being accessed at the same time by the circuit diagram. These operands must not therefore be used again in a coil field.

In the event of dual access, the operand always takes on the state of the last completed access. The button actuation of the operator may therefore be immediately undone by the circuit diagram.

Programming in easySoft-Pro - parameterization

- ▶ First select in the Negate bit variable area, Associate via list box: Boolean operand or function block inputs as associated variable.
- ▶ Finally select the operand.

This completes the parameterization.

6.6.11 Disable Change to Status Display

With this button element, you can disable the predefined function of the Mode or * button on the MFD, via which you return to the Status display from the visualization. This prevents the possibility of manipulations on the operating state or program of the MFD.

This pushbutton element is not required if you have already assigned another pushbutton function to the mode pushbutton.

Programming in easySoft-Pro

Requirement for using the button element:

- You must use an MFD-CP8... device from device version number 05 or an MFD-CP10... device.
- You must have edited at least one screen from which a switch to the Status display is not permissible.
- You must also have switched to the button editor.

- ▶ First select the screen from which Status display should not be accessible.
- ▶ Left-click the Mode pushbutton.
- ▶ Then drag the Disable Change to Status Display button element into the Button Functions list box.

Parameter definition

No parameters are required for this button element.

6.6.12 P button function

The P pushbutton operands are used in the circuit diagram as contacts, so that you can switch using the cursor buttons during operation, → Section "4.7.9 Switching with the Cursor Buttons", page 172.

As soon as you have edited a screen on the MFD in which different functions can be assigned to the operator buttons, the P buttons lose initially this contact function. When used in the circuit diagram they take on the value 0.

In order to use P buttons for switching in a visualization and wire them as contacts, assign each of these buttons simply to the **P button function** element. In other words: This P button function causes the device to also respond in the visualization to the actuation of a cursor button in exactly the same way as if it was in the Status display.

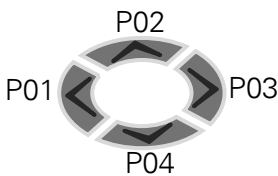

Function

The cursor buttons < ^ > v are assigned to the operands P01 - P04 in this order (only with MFD devices with display module and function keys)

The other operator buttons on the MFD-CP10... can also be used as additional inputs. The following table shows the assignment of the other operator buttons of the MFD-CP10....

Contact	Operator Button
P05	OK
P06	ESC
P07	DEL
P08	ALT
P09	*-pushbutton (mode pushbutton)



The P button function is an exclusive function. It should therefore be entered separately in the Button functions list. The device will ignore any other button elements that you drag into the Button functions list.

6 Visualization with MFD-Titan

6.6 Button Editor

Under the following conditions the cursor buttons $\wedge \vee \langle \rangle$ and the other operator buttons of the MFD-CP10... will retain their previous function in the visualization even with the P button function active:

- If the device is in Entry mode and you wish to define setpoints, for example, using Value entry screen elements.
- If the device is in element selection mode and you wish to select a screen element.
- If the device is in the Screen password entry mode.

Programming in easySoft-Pro

Requirement for using the button element:

- You must use an MFD-CP8... device from device version number 05 or an MFD-CP10... device and must have activated the "P pushbuttons" option in the "System settings" tab.
- You must have edited at least one screen and have switched to the button editor.
 - ▶ First select the required screen.
 - ▶ Then left-click the cursor button to be enabled, e.g. the > pushbutton.
 - ▶ Then drag the P button function in the Button functions list.

Parameter definition

No parameters are required for this button element.

6.6.13 Go To Previous Screen

The Go to previous screen function enables you to undo the last screen change by button actuation during operation.

Function

With every screen change, the device remembers the previously displayed screen, regardless of whether the change was initiated by the operator or by a screen actuation in the circuit diagram. Thus function is only used sensibly when the change is initiated by the operator.



The Go to previous screen function is a closing function. Because the actual screen is closed after this function is executed, no further actions are possible that are associated with this screen.

This means that this function should always be the last function in the Button functions list when a button is assigned functions. This must also be taken into account when later reversing the order with the Up / Down buttons.

Programming in easySoft-Pro

Requirement for using the button element:

- You must use an MFD-CP8... device from device version number 05 or an MFD-CP10... device.
 - You must have edited at least two screens and have switched to the button editor.
- ▶ First select the required screen.
 - ▶ Then left-click the required pushbutton.
 - ▶ Then drag the button element to the Button functions list.

Parameter definition

No parameters are required for this button element.

6.6.14 Disable Selection Mode

This function is used to disable on the MFD the predefined function of the OK pushbutton via which the operator enters Selection mode.

Function

This function prevents unauthorized value entries in the screen entry elements of the associated screens.

This button element is not required if you have already assigned another button function to the OK button.

Programming in easySoft-Pro

Requirement for using the button element:

- You must use an MFD-CP8... device from device version number 05 or an MFD-CP10... device.
 - You must have edited at least one screen and have switched to the button editor.
- ▶ First select the required screen.
 - ▶ Then left-click the OK button.
 - ▶ Then drag the Disable Selection Mode button element into the Button Functions list box.

Parameter definition

No parameters are required for this button element.

6.6.15 Jump Label

Requirement: You must use an MFD-CP8... device from device version number 05 or an MFD-CP10... device.

The sole task of the Jump label function is to define the destination for the Conditional jump button function. The combination of these two button functions enables sections of the button functions list to be skipped depending on the status of a user-defined Boolean operand.

6 Visualization with MFD-Titan

6.6 Button Editor

6.6.15.1 Programming in easySoft-Pro

Requirement for using the button element:

- You must use an MFD-CP8... device from device version number 05 or an MFD-CP10... device.
- You must have edited at least one screen and have switched to the button editor.
- The Button functions list must contain several button elements.
- ▶ Then left-click the required pushbutton.
- ▶ Then drag the Jump label function in the Button functions list behind the button elements to be skipped.



If you later add the Conditional Jump and Jump Label functions to the button functions list, use the Up/Down buttons to place the functions in the required positions.

Parameter definition

- ▶ Define the jump destination within the list using the number in the Jump label list box.

This completes the parameterization.

6.6.16 Conditional Jump

The Conditional Jump function enables parts of the Button functions list to be skipped according to the state of a freely selectable Boolean operand. The state of this operand therefore determines by which function keys of the MFD newly assigned functions are called or not.

Function

The Conditional Jump function can only be used in conjunction with the Jump Label function. Both functions form a bracket for the button elements to be skipped. Only forward jumps are possible.

Programming in easySoft-Pro

Requirement for using the button element:

- You must use an MFD-CP8... device from device version number 05 or an MFD-CP10... device.
- You must have edited at least one screen and have switched to the button editor.

- ▶ First select the required screen.
- ▶ Then left-click the required pushbutton, e.g. the ESC pushbutton.
- ▶ Then drag the Conditional Jump button element function to the Button functions list in front of the button function to be skipped.
- ▶ If necessary, position the function in the Button function list using the Up/Down buttons.

Example

The Increment variable button function is to be skipped and thus made inactive. The Button function list will then have the following appearance:

```
Conditional Jump 1
Increment Variable
Jump Label 1
```

Parameter definition

- ▶ In the Conditional Jump tab, assign a Boolean operand to the Conditional Jump button element, for example input I1.

If voltage is applied to this input, the Increment variable button element cannot be executed by actuating the ESC button.

- Boolean operands
The Operand and Number fields are active. You can choose a Boolean operand as an operand.

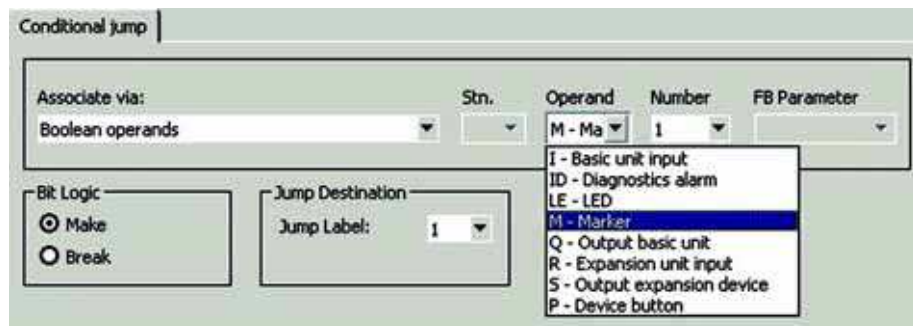

Figure 263: Window Conditional Jump

- Function block inputs and outputs
The Operand, Number and FB Parameter fields are active. In the Operand field select the function block type, in the Number field the number and in the FB Parameter field the input or output.

This completes the parameterization.

6.7 Password Protecting Screens

The access authorisation for an installation managed by a visualization application can be controlled with the password protection function. For this you protect a screen with a password. The password responds to access to the screen, e.g. by a screen change, in the following way:

- On MFD-CP8... devices up to device version number 04 the protected screen is shown. However the operator has no access to screen elements via which a value entry can be made.
- On MFD-CP8... devices from device version number 05 and MFD-CP10... devices, the password entry screen is shown instead of the protected screen. The screen is only shown after the password is entered.

You can configure up to three passwords. During operation, any of the three passwords entered will allow access to the screen. In this way, up to three operators can access the screen independently of each other.



The password protection for screens must not be confused with the system password protection, which is used for calling the System menu functions, → section "8.1 Safety", page 445 . The password request function is not factory set in easySoft-Pro.

Valid passwords

5-digit decimal number 1 – 99999, without letters. A 0 corresponds to a deleted password. Changing passwords on the MFD at a later time is not possible.

6.7.1 Configure password

You configure a password and the logout time in easySoft-Pro via Visualization View -> Screen overview -> Passwords tab. This is described in the Help.

6.7.2 Language adaption of the title text "PASSWORD ENTRY:"

When using an MFD-CP10... the user can adapt the PASSWORD ENTRY title text shown in the password request screen to the language used. The entry option is provided in the existing **Passwords** tab.

- ▶ Activate the option Language Adaption.
- ▶ In the Language selection list box choose one of the languages defined in the Languages tab, such as English, and enter the translated title text (max. 16 characters) "ENTER PASSWORD" in the Text: field.

If the Default text option is selected, as with the MFD-CP8... - the menu text present in the device is used.

6.7.2.1 Accessing a password protected screen

On MFD-CP8... up to version number 04

The password is requested if you start a value entry or actuate an operator button that is assigned function. The screen protected by the password is already displayed on the device. This password concept allows the change to the protected screen but then prevents any unauthorized operations.

The password is requested once more when further operator entries are required after the logout time for the password has elapsed.

On MFD-CP8... from version number 05 and on MFD-CP10...

On MFD-CP8... devices from device version number 05 and MFD-CP10... devices, the password request appears in the password entry window already when the protected screen is called. This screen will not be displayed until the correct password has been entered.

The request must always be repeated if:

- the logout time for the password has elapsed.
- the logout time was ended by the operator (Password logout function).
- a protected screen is to be activated from the circuit diagram (via screen control)

6.7.3 Logout Time

If you have opened a screen using the password entry, you can then, for example, carry out a value entry. The logout time is started after the password is entered. You can make several entries during this logout time without having to re-enter the password. You can move from this screen to another one and then return to the original screen without a password entry being necessary.

6.7.3.1 Configure Logout Time

After you have entered the password in the tab Screen Overview -> Passwords, you can also enter the logout time (0, 1 - 255 minutes) in the same line. A logout time of 0 minutes means the time for which the password is valid does not elapse. The access rights to this current screen after entering the password is retained until the next time that the device is switched to STOP.

6.7.4 Password entry in run

Enter as password the fixed maximum of five numbers in the password entry window.



Figure 264: Password entry window

To enter the password use the cursor buttons $\wedge \vee \langle \rangle$, the OK button and the ESC button. After an incorrect password entry any number of further attempts are possible. You can cancel password entry with the ESC button, however, the required access will still remain disabled.

In line 2 enter the five password digits. The first digit is already pre-assigned with 0. For example enter digits 0 0 0 5 4 for the password 54.

Line 3 shows the password entry window in square brackets with which one of three possible passwords can open the current screen. Passwords 1 and 3 were configured in the above figure.

- ▶ Complete the correct password entry with the OK pushbutton.

Screen access is retained:

- Until the defined logout time has elapsed.
- Until an operator button assigned with the Password logout function was pressed.
- Until the MFD switches to STOP operating mode.
- ▶ Use the ESC pushbutton to cancel the password entry. However, screen access will still be disabled. The screen to be displayed after an abort depends on the setting and the version of the MFD used (→ After abort PW entry in the easySoft-Pro Help).

6.7.5 Schematic procedure for password entry by the operator

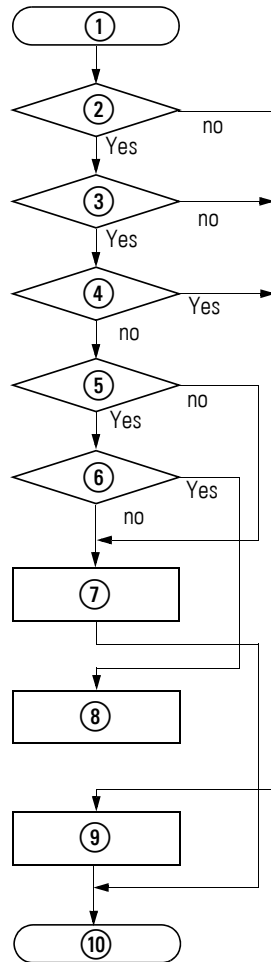

Figure 265: Password entry

- ① Operator entry **Move to a different Screen**
- ② Is the **Password request active** function activated in the Passwords tab?
- ③ Is the screen password protected? You activate password protection separately for each screen by selecting **Yes** in the **PW-x** field of the **Screens** parameter table.
- ④ Has the password been entered correctly and has **OK** been pressed?
- ⑤ Has the password entry been aborted with **ESC**?
- ⑥ Has an alternative screen in the event of an abort with ESC been defined?
- ⑦ The previous screen will continue to be displayed. Password entry is possible again.
- ⑧ The alternative screen is shown (only from device version number **05**).
- ⑨ The protected screen is shown.
- ⑩ End of screen change.

6 Visualization with MFD-Titan

6.7 Password Protecting Screens

7 The network easyNet

7.1 Introduction network easyNet

The easyNet network, termed the NET in the following document, is based on the CAN (Controller Area Network) serial bus system. CAN complies with the ISO 11898 standard.

The NET is designed for up to 8 stations.

Using the NET you can:

- Process additional inputs and outputs.
- Implement faster and improved control using decentralised programs.
- Synchronise date and time
- Read and write inputs and outputs.
- Send values to other stations.
- Receive values from other stations.
- Load programs from or to any station.

NET stations can be allMFD devices with a network connection (MFD-...-NT).



Distribute the tasks over several devices that exchange the data between each other via NET: easy800 or MFD devices for open-loop and closed-loop control and MFD devices for display and HMI tasks.

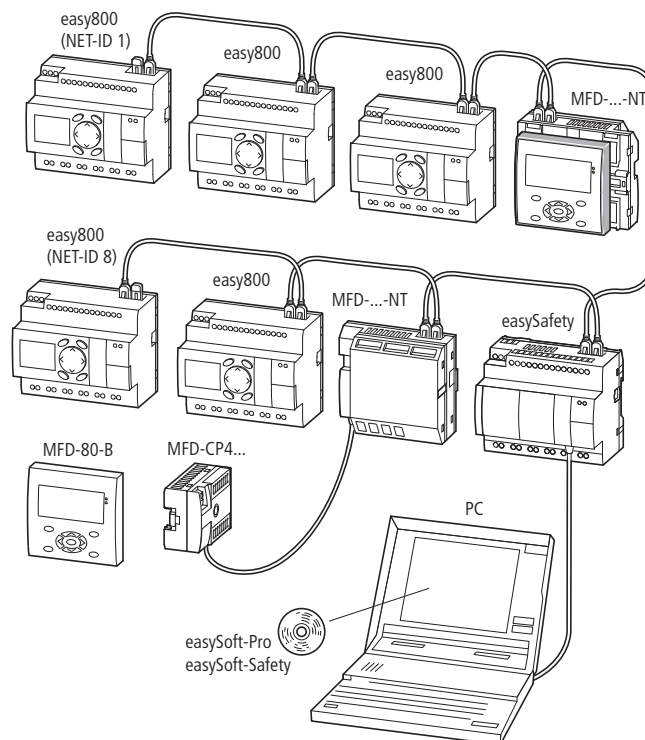

Figure 266: Mixed operation of NET stations

7 The network easyNet

7.1 Introduction network easyNet



An MFD can either run as a NET station or as a station in a COM-LINK connection.

Only the physically first NET station that is located at the beginning of the network manages the configuration and commissioning of the NET. In this way, the commissioning of NET stations is very simple. Apart from the installation with prefabricated cables, this only requires the following for the standard "loop through" topology:

- Definition of the first NET station by assigning NET ID 1 and the possible necessary modification of the baud rate in the NET PARAMETERS menu.
- Creation of the station list with automatic assignment of the NET IDs for the connected devices in the STATION menu.
- Configuration via the CONFIGURATION menu.

Further information on the configuration of the NET can be found on page 127.

Commissioning is even simpler when using easySoft-Pro. Information on this is provided in the Online Help of easySoft-Pro.



DANGER

Ensure that the automatic starting of MFD will not cause the unwanted starting of machines and plants.

7.1.1 Transfer behavior of the NET stations

In addition to the process that runs the program, a device with a NET connection also runs a parallel communication process that controls the exchange of network data.

Before every program cycle the network data is written from the NET receive buffer to the operand image of the program. The program runs through the next cycle with this data. At the end of the program cycle, the updated network data is written from the operand image to the NET send buffer and then transferred.

7.1.1.1 Reading and sending the data via the NET

The communication process of a NET station reads every message on the NET and checks whether any messages are meant for its own address (NET ID). If yes, they are transferred to a receive memory.

If the content of the send memory changes, a message is sent provided that no other message is being transferred on the NET at this time. The NET ensures that each station can send its messages. This means that each station must maintain a delay time between the sending of messages.

The pause time increases the higher the number of stations and the lower baud rate setting.

The number of NET stations present is recognized by every station by means of a "sign of life" signal.



The following applies to a fast message transfer:

- Set the fastest possible baud rate to suit the network length and cable cross-section.
- Fewer messages means faster messages.
- Avoid program transferring (download/upload) a circuit diagram while the NET stations are in RUN mode.

7.1.2 Functions of the NET stations

The different types of NET stations vary according to their technical overview:

- easy800 control relay,
- MFD-...-NT operating and visualization devices
- Safety control relay (ES4-...)
- SmartWire gateways (without program, with configuration)
- Control systems EC4-200 and
- XC200 controllers

7.1.2.1 Net stations with or without program

- NET stations with their own program.
 - Possible NET IDs: 01-08
 - Possible devices: All
- NET stations without their own program, as input/output devices in REMOTE IO mode. In this type of application, NET station 1 must always have a program.
 - Possible NET IDs: 02-08
 - Possible devices: easy800 and MFD



MFD devices cannot be run in REMOTE IO mode as a NET station. These always require a circuit diagram.

7.1.3 Function "terminal mode"

Terminal mode allows you to use the operating buttons of an MFD-...-NT, which is run as a NET station to create or modify the standard circuit diagram (the program) of another NET station → section "3.9.2 MFD as NET station", page 138.

7.2 Description of the NET-PARAMETERS

The NET parameters described below can be found in the NET PARAMETERS menu:

- ▶ Simultaneously press the DEL and ALT buttons with the status display active. Then choose CONFIGURATOR -> NET -> NET PARAMETERS and press the OK button.

7.2.1 Station number (Station Menu NET-ID)

Factory setting NET ID = 00.

Selectable, valid NET-IDs 01 - 08.

The NET ID of a device is used to give it a unique identification on the NET. A NET ID can therefore only be assigned once within a network.

The factory setting NET ID 00 prevents the possibility of double addressing when an existing NET station (NET ID 1- 8) has to be replaced.

7.2.2 Data transfer speed (Station Menu BAUD RATE)

Factory set baud rate = 125 KB.

The devices allow a NET transfer speed of 10 - 1000 Kbaud, selectable in defined steps. Possible baud rates are: 10, 20, 50, 125, 250, 500 and 1000 KB.

- ▶ Use ^ and v to select a baud rate of 10 - 1000 KB and confirm your selection with OK.



All NET stations must have an identical transfer speed set. This is achieved automatically if you carry out the NET configuration via NET station 1 (→ section "3.7.2 Configuring NET", page 127).

The maximum transmission speed depends on the total length of the network cables (a Technical data, → Section "11.3.8 NET easynetwork" on page 515).



The reaction speed of devices connected via the NET depends essentially on the baud rate, the delay time and the volume of transferred data.

Therefore always set the maximum transfer speed. The factory set baud rate depends on the total length of the network cables of 125 m.

A maximum baud rate is therefore very important if an MFD is required to work on the NET since additional NET transfer time is needed.

7.2.3 Pause time, changing the write repetition rate manually (Station Menu BUSDELAY)

Factory setting: Bus delay time = 0 (recommended setting that you should only change for the reasons stated below).

In normal operation, the NET stations organize their data exchange independently. The NET stations also determine the minimum delay time required so that all messages can be sent.

Use BUS DELAY to change a multiplier that increases the bus delay time [tp] between the transmission cycles of user data in the NET.

- A value 1 means that the bus delay time is doubled.
- A value 15 means that the bus delay time is increased tenfold.



All NET stations must have an identical bus delay time set. This is achieved automatically if you carry out the NET configuration via NET station 1 (→ section "3.7.2 Configuring NET", page 127).

- ▶ If necessary, use \wedge and \vee to set a multiplier of 1 - 15 and confirm your selection with OK.

$$tp_{\text{new}} = tp \times (1 + n)$$

tp_{new} = new bus delay time

tp = bus delay time determined by the network

n = Value at BUS DELAY

Even if a maximum baud rate is set, it may be necessary to increase the bus delay time for the following reasons:

- In addition to the user data, additional data is transferred to the PC, i.e. to easySoft-Pro in Online status or to an MFD in terminal mode.
- The transfer rate is low.

By increasing the bus delay time you increase the time window for online services such as the power flow display, status display of actual values of function block operands and the forcing of markers.

An increase of the bus delay time is only really necessary in the following conditions:

- You use an MFD in terminal mode via the NET and see the message "Connection establishment in progress...". In this case the bus delay time must be increased permanently.
- You wish to use the online services of the easySoft-Pro programming software via the NET. In Communication View, however, you will receive the error message "Device not responding". This fault message appears if you wish to establish an online connection or are already online. In this case, a temporary increase of the bus delay time is useful. It should be reduced after commissioning.

7 The network easyNet

7.2 Description of the NET-PARAMETERS

Remember also that the easySoft-Pro programming software displays status changes more quickly on the device if you select the maximum PC baud rate.



An increase in the bus pause time means that fewer messages (inputs, outputs, bit data, word data) are transferred per time unit.

The reaction speed of all devices connected via the NET depends essentially on the baud rate, the delay time and the volume of transferred data.

You should therefore retain the proposed bus delay of the multiplier 0!

7.2.4 Send each change on the inputs/outputs (Station Menu SEND IO)

Factory setting SEND IO = On

SEND IO	✓
---------	---

Activate the SEND IO if you require short reaction times to each status change on the input or output of a NET station (e.g. at 2I 02, 8Q 01, etc.).

Activate the SEND IO function if all NET stations are to be notified immediately of a status change at the input or output of a NET station (e.g. at 2I 02, 8Q 01, etc.).

In addition to the cyclical data transfer, the status change will be sent to all other NET stations in a separate telegram.

NET stations without a circuit diagram send each status change of an input or output, without taking the SEND IO setting into account.

An activated SEND IO function will considerably increase the number of telegrams on the NET and can slow down the transfer of other user data.



If you are using a high-speed counter (e.g. CH01) with constantly changing input data in the circuit diagram of a NET station, SEND IO should be deactivated for this station.

Otherwise the station changes at the counter input will unnecessarily increase the number of telegrams on the NET. Transfer these status changes with SN/RN operands.

7.2.5 Automatic change of the RUN and STOP mode (Station Menu REMOTE RUN)

Factory setting REMOTE RUN = On

REMOTE RUN must be activated on NET stations with NET ID 2 - 8 which are required to automatically follow the operating mode change of the NET station with NET ID 1.



If you are currently setting the station with NET ID 1, the REMOTE RUN function is therefore not required and is not available here.



Danger

Ensure that the automatic starting of MFD will not cause the unwanted starting of machines and plants.



NET stations with a circuit diagram and a display only follow the operating mode change if the status display or a text is showing in the display on the device.

7.2.6 Configuring an input/output device without its own circuit diagram (REMOTE IO menu item)

Factory setting REMOTE RUN = On

If the REMOTE IO mode is switched on, and only if they do not have their own circuit diagram, the conventional NET stations with NET-ID 2 - 8 function as input/output devices.



By default all devices except are configured as input and output devices, which make their inputs and outputs available to the NET station with NET-ID 1. This has the advantage that devices can be used immediately as I/O devices, regardless of whether they have a display or not. You must only assign the NET-ID, baud rate and bus delay to this type of device.

As soon as you enter a circuit diagram on this kind of NET station with NET ID 2 - 8, the REMOTE IO function is automatically deactivated.

This prevents write access to the outputs of this kind of NET station, both locally from its own circuit diagram as well as from REMOTE station 1.

The standard settings for the input and output devices are:

SEND IO	✓
REMOTE RUN	✓
REMOTE IO	✓

7 The network easyNet

7.3 Network transmission security

7.3 Network transmission security

easyNet is a CAN-based network with the same error detection capability as CAN. A BOSCH study relating to undiscovered and corrupt messages determined the following:

The probability of non-discovery of a corrupted message (residual error probability) is:

< 10^{-10} message error rate.

The message error rate depends on:

- Bus loading
- Telegram length
- Malfunction frequency
- Number of stations

Example using a network with:

- 500 Kbaud
- average bus load 25 %
- average operating time 2000 h/year
- average error rate of 10^{-3} , i.e.: 1 message is faulty every 1000
- transmission of 1.12×10^{10} messages per year of which 1.12×10^7 messages are faulty
- residual error probability: $r < 10^{-10} \times 10^{-3} = 10^{-13}$

This means: one of 10^{13} messages is so corrupt that the fault cannot be recognised as such. For a network, this corresponds to a working time of approx. 1 000 years.

8 MFD Settings

The following MFD settings are only possible with devices provided with operator buttons and a display. These settings must be carried out in the main or System menu.

Alternatively use the easySoft-Pro programming software to complete all the settings via the software.

8.1 Safety

8.1.1 Password protection

Password protection prevents access to different areas such as the CIRCUIT DIAGR., CLOCK or the serial INTERFACE. Further information on the areas concerned → section "Protecting special areas", page 446. The System menu is always protected when a password is activated.



A password entered in the MFD device is transferred to the memory card with the circuit diagram, irrespective of whether it was activated or not.

If this MFD circuit diagram is reloaded from the card, the password is also transferred to the MFD device and is activated immediately.

8.1.2 Inputting a password

You can set up a password in the System menu, irrespective of whether RUN or STOP is selected. You cannot enter the System menu if a password is already activated.

Numbers between 0 and 9 can be used for the password. In this case the password consists of a value between 000001 and 999999.

- ▶ Press DEL and ALT to call up the System menu.
- ▶ Select the menu option SECURITY... to enter the password.
- ▶ Press the OK pushbutton and enter the STD PASSWORD.
- ▶ Press OK once more to enter password entry mode.

```
PASSWORD...  
RANGE...
```

```
PASSWORD ENTRY:  
█-----
```

If still no password has been entered, MFD device changes directly to the password display and displays six dashes: No password available.

- ▶ Press OK to cause six zeros to appear.
- ▶ Set the password using the cursor buttons:
 - < > Select position in the password.
 - ^ v set a value between 0 to 9.

8 MFD Settings

8.1 Safety

- use <> to select other positions in the password as required and select a value between 0 to 9.

```
ENTER PASSWORD
000042
```

- ▶ Press OK to save the new password.

Use OK to exit the password display and proceed with ESC and \downarrow to the RANGE... menu. You can define here which area you wish to protect with the password.

Protecting special areas

```
Circuit Diagram ✓↑
PARAMETER
CLOCK
OPERATING MODE ↓
INTERFACE
DELETE FUNCTION
```

- ▶ Select the function or the menu to be protected.
- ▶ Press the OK in order to protect the function or the menu (✓ = protected).



At least one area must be protected. In the default setting the circuit diagram is selected.

- CIRCUIT DIAGRAM: The password is applied to the circuit diagram as well as function blocks that are not enabled. This area also prevents the transfer of a circuit diagram from and to the memory card.
- PARAMETER: The PARAMETER menu is protected.
- CLOCK: Date and time are protected with the password.
- MODE: It is not possible to change the operating mode from RUN to STOP and vice versa using the operating buttons of the device concerned. The same applies for the easySoft-Safety Run/Stop buttons.



DANGER

This password protection does not prevent operating mode changes in the following cases:

- With REMOTE RUN activated the NET station 2-8 follow the operating mode change of the NET station with NET-ID 1, → Section "7.2 Description of the NET-PARAMETERS" -> „Automatic change of the RUN and STOP mode (Station Menu REMOTE RUN)" on page 443.
 - Operating mode changes can also be triggered through local expansion units (communication modules).
- INTERFACE: Protects against access to the multi-function interface of this device. Data exchange via the easyNet is not affected. Take into account the restricting effect of a protected interface if you have to reset the MFD device to factory settings (→ Section "8.1.7 Password no longer known or incorrect", page 449).
 - DELETE PROGRAM: When this function is not activated, the question "DELETE PROG?" will appear if the password entry is entered incorrectly four times. This question does not appear if you activate this function and protect the DELETE PROGRAM area. However, it is no longer possible to make changes in protected areas if you forget the password.

The password is now valid but not yet activated.

8.1.3 Activating Passwords

An already entered password can be activated in four ways in order to activate password protection:

- via the password menu (see below)
- automatically when the device is switched on again.
- automatically after a protected circuit diagram is loaded.
- automatically if 30 minutes after unlocking
 - a telegram is not sent from easySoft-Safety via the multi-function interface.
 - a pushbutton is not actuated.

Activating password via the password menu



CHANGE PW
ACTIVATE PW

- ▶ In the system menu enter the ACTIVATE PW menu via SAFETY -> PASSWORD.

The device shows this password menu only if a password is present.

- ▶ Then press the OK button.



Make a notes of the password before activating it. If the password is no longer known, the device can be unlocked if the DELETE PROG area was not activated. However, the circuit diagram and data settings will be lost.

CAUTION

The following applies if the password is not known or is lost and the Delete password function is disabled: The device can only be reset to the factory setting at the manufacturers. The program and all data will be lost.

- ▶ If you have deactivated a password beforehand, select ACTIVATE PW in the system menu and press OK.

The password is now active, i.e. password protection is activated.

You must unlock the device with the password before you implement a protected function, enter a protected menu or the System menu.

8 MFD Settings

8.1 Safety

8.1.4 Unlocking MFD

Unlocking MFD deactivates password protection. You can then activate password protection later via the Password menu or by switching the supply voltage off and on.



The function of an area is accessible if a password is entered to unlock an area. All other functions protected by this password are now also unlocked.

The procedure to unlock the configuration or parts of it is always the same.

```
PASSWORD...
STOP RUN ✓
PARAMETER
SET CLOCK...
```

- ▶ Press OK to enter the main menu. The PASSWORD... menu item will flash.
- ▶ Press OK to enter the password entry menu.



If MFD shows the PROGRAM main menu instead of PASSWORD, this means that no password protection is active.

```
ENTER PASSWORD
XXXXXX
```

The MFD device shows the password entry field.

- ▶ Set the password using the cursor buttons.
- ▶ Confirm with OK.

The MFD device will automatically return to the status display if the password is entered correctly.

```
PROGRAM...
STOP
PARAMETER
SET CLOCK...
```

The PROGRAM menu option is now accessible so that you can edit your circuit diagram.

The System menu is also accessible.

8.1.5 Changing passwords

- ▶ Unlock the MFD device as previously described.
- ▶ Press DEL and ALT to call up the System menu.
- ▶ Open the password menu via SECURITY... -> PASSWORD...->CHANGE PW.

```
CHANGE PW
ACTIVATE PW
```

The CHANGE PW entry flashes.

The MFD device only shows this menu if a password is already assigned.

```
PASSWORD ENTRY:
XXXXXX
```

- ▶ Press OK to enter the password entry menu.
- ▶ Press OK to move to the 6-digit entry field.

The current password will be displayed.



- ▶ Modify the six password digits using the cursor buttons.
- ▶ Confirm with OK.

Use ESC to close the entry screen.

8.1.6 Delete password



- ▶ Press DEL and ALT to call up the System menu.
- ▶ Open the password menu via SECURITY... -> PASSWORD...->CHANGE PW.

If a password is not entered, the MFD device shows six dashes. An existing password is displayed with XXXXXX.

Use number combination 000000 to delete a password.

8.1.7 Password no longer known or incorrect

If you no longer know the exact password, you can try to re-enter the password several times. If the DELETE PROG function is activated in the AREAS menu, the password can be entered as often as required.



Assumption: The DELETE PROG area was not selected,
→ Section "Protecting special areas", page 446.



Have you entered an incorrect password?

- ▶ Re-enter the password.

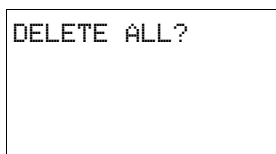

After the fifth entry attempt MFD device will ask whether you wish to delete the circuit diagram and data.

- ▶ Press
 - **ESC**: Circuit diagram, data or password are not deleted.
 - **OK**: Circuit diagram, data and password are deleted.

easy will return to the Status display.



If you no longer know the exact password, you can press **OK** to unlock the protected easy. The saved circuit diagram and all function relay parameters will be lost.

Pressing **ESC** will retain the circuit diagram and data. You can then make another five attempts to enter the password.

8 MFD Settings

8.2 System

8.2 System

8.2.1 Switching on the input delay function (Debounce menu)

The MFD device is factory set to evaluate input signals with an input delay, the so-called DEBOUNCE function. This ensures that any contact bouncing of switches and pushbuttons is masked out.

The input delay is set in the System menu.

However, for many applications, it is necessary to evaluate very short input signals. In this case, the debounce function can be switched off.

- ▶ Press DEL and ALT to call up the System menu.
- ▶ Move to the menu SYSTEM and then to the DEBOUNCE menu.



If the MFD device is protected with an STD PASSWORD, you must remove password protection before you can call the system menu.

8.2.1.1 Activating DEBOUNCE

```
DEBOUNCE ✓↑
P PUSHBUTTONS
RUN MODE
CARD MODE ↓
```

- ▶ To activate DEBOUNCE, choose DEBOUNCE and press OK. The debounce is activated and the display changes to DEBOUNCE ✓.
- ▶ Press ESC to return to the previous menu.

8.2.1.2 Deactivating DEBOUNCE

If the menu displays DEBOUNCE ✓ (with a tick), this means that the debounce function is already activated.

- ▶ To deactivate DEBOUNCE, choose DEBOUNCE ✓ and press OK. Debounce mode will be deactivated and the display will show DEBOUNCE without a tick.



How MFD input signals are processed internally, → Section "9.2.1 Input delay (debounce)", page 474.

8.2.2 P PUSHBUTTONS

Even though the cursor buttons (P buttons) have been set as contacts in the circuit diagram, these are not activated automatically. In order to prevent accidental actuation, the cursor buttons cannot switch until they have been activated.

The other operator buttons on the MFD-CP10... can also be used as additional contacts.

Activate the P buttons in the System menu.



If MFD is protected with a password, you must remove password protection before you can call the system menu.

The P pushbuttons are activated and deactivated via the P BUTTONS menu.

```
DEBOUNCE ✓ ↑
P PUSHBUTTONS
RUN MODE
CARD MODE ↓
```

- ▶ Press DEL and ALT to call up the System menu.
- ▶ Select the SYSTEM menu.
- ▶ Move the cursor to the P BUTTONS menu.

8.2.2.1 Activating P pushbuttons

```
DEBOUNCE ✓ ↑
P BUTTONS ✓
RUN MODE
CARD MODE ↓
```

If is displaying MFD P PUSHBUTTONS ✓, this means that the P pushbuttons are active.

- ▶ Otherwise select P PUSHBUTTONS and press OK.

The MFD device changes the display to P BUTTONS ✓ indicating that the P buttons are activated.

- ▶ Press ESC to return to the status display.



The P pushbuttons are only active in the status display and the text display. In this display you can use the P buttons to activate inputs in your circuit diagram.

8.2.2.2 Deactivating the P pushbuttons

- ▶ Select P PUSHBUTTONS ✓ and press OK.

The tick behind P PUSHBUTTONS disappears and the P pushbuttons are deactivated.



The P buttons are automatically deactivated if you load a circuit diagram from the memory card or via easySoft-Pro onto the MFD device or if you are deleting a circuit diagram in the MFD device.

8 MFD Settings

8.2 System

8.2.3 Setting the startup behavior

The startup behavior is an important aid during the commissioning phase. The circuit diagram which MFD contains is not as yet fully wired up or the system or machine is in a state which MFD is not permitted to control. If MFD device is then switched on, it should not be possible to activate the outputs.

Set the Startup behavior in the system menu.

➔ The MFD devices without a display can only be switched to RUN MODE without the programming software by activating RUN MODE as startup behavior. This change is possible if the MFD device contains a valid circuit diagram.

▶ Switch to the system menu.

➔ If the MFD device is password protected, the System menu is only accessible after the device has been unlocked (➔ Section "8.1.4 Unlocking MFD", from page 448).

▶ Set whether the MFD device is to switch to RUN mode or not when the supply voltage is switched on.

The MFD devices without a display start up automatically when RUN MODE is active.

8.2.3.1 RUN MODE

Activating RUN mode

If the MFD device shows RUN MODE ✓, the device will start in RUN mode when the supply voltage is switched on. However, if there is no circuit diagram in the device, it will stay in STOP operating mode until a circuit diagram is entered or downloaded.

```
DEBOUNCE✓   ↑
P PUSHBUTTONS
RUN MODE    ✓
CARD MODE   ↓
```

▶ Otherwise select RUN MODE and press OK.
RUN mode is activated.

▶ Press ESC to return to the status display.

Deactivating RUN mode

▶ Select RUN MODE ✓ and press OK.

The RUN mode function is deactivated.

The MFD device is factory set with RUN MODE ✓ displayed, i.e. the device starts in RUN operating mode when the voltage supply is switched on.

```
DEBOUNCE✓   ↑
P PUSHBUTTONS
RUN MODE
CARD MODE   ↓
```

Menu displayed	Status of MFD after startup
RUN MODE	MFD is in STOP mode
RUN MODE✓	MFD switches to RUN mode

Behavior on deleting the circuit diagram

The setting for the startup behavior is an MFD device function. When the circuit diagram is deleted this does not result in the loss of the setting selected.

Behaviour during upload/download to card or PC

The setting is retained if a valid circuit diagram is transferred from MFD device to a memory card or PC. This also applies in the opposite direction, i.e. from the memory card or PC to the MFD.



The MFD devices without a display can only be started in RUN mode.

Possible Faults

MFD device will not start in RUN mode:

- A program is not available in MFD device.
- You have put MFD in STOP mode (RUN MODE menu).

8.2.3.2 CARD MODE

The Card mode startup is designed for applications in which a program change can even be carried out by unskilled personnel by simply exchanging the memory card.



Card mode functions:
on the MFD-CP8... only with the EASY-M-256K memory card.
on the MFD-CP10... only with the EASY-M-512K.

If the program on the memory card is different to the program in the MFD device, the program from the card will be loaded on power up first of all and then started in RUN mode. If the programs only contain different function block setpoints (constants), the program on the memory card is not loaded. The program is retained in the device and is started.

Factory setting: CARD MODE inactive

- ▶ Switch to the system menu.



If the MFD device is password protected, the System menu is only accessible after the MFD device has been unlocked (→ Section "8.1.4 Unlocking MFD", from page 448).

8 MFD Settings

8.2 System

```
DEBOUNCE √↑
P PUSHBUTTONS
RUN MODE √
CARD MODE √↓
```

Activation of CARD MODE

- ▶ Otherwise choose `CARD MODE` and press OK.

The MFD device now displays `CARD MODE √`.

- ▶ Return to the status display using ESC.



If `CARD MODE` is activated:

- A MFD device only switches to RUN mode on power up if a memory card with a valid program is fitted.
- An MFD device cannot be switched to RUN mode on power up if the program in the MFD device is different to the program on the memory card. First the modified program must be transferred to the card or `CARD MODE` must be deactivated.

Deactivating CARD MODE

- ▶ Select `CARD MODE √` and press OK.

The `CARD MODE` function is deactivated.

```
DEBOUNCE √ ↑
P PUSHBUTTONS
RUN MODE √
CARD MODE ↓
```

8.2.4 TERMINAL MODE startup (TERMINAL MODE menu item)

The startup behavior of an MFD with automatic start in Terminal mode is designed for applications in which other devices are remotely controlled by the MFD, → Section "3.9 Running MFD in Terminal mode", page 136, .

In the SYSTEM menu you set the MFD to switch to TERMINAL MODE when the voltage supply is switched on and establish a connection to the defined station. The setting of the connection to the required station, → Section "3.9 Running MFD in Terminal mode", page 136.

8.2.4.1 Activating an automatic startup in TERMINAL MODE

Terminal mode is deactivated in the factory setting.

- ▶ Press DEL and ALT simultaneously to switch from the Status display to the System menu.



If the MFD is password-protected, the System menu can only be accessed after the device has first been "unlocked" (→ Section "8.1.4 Unlocking MFD", from page 448).

```
P PUSHBUTTONS  ↑  
RUN MODE  
CARD MODE  
TERMINAL MODE  √↓
```

- ▶ Choose **TERMINAL MODE** and system menu and press OK.

At the next startup, the MFD device will establish a connection to the set station.

- ▶ Press ESC twice to return to the Status display.

8.2.4.2 Deactivating automatic startup in **TERMINAL MODE**

```
P PUSHBUTTONS  ↑  
RUN MODE  
CARD MODE  
TERMINAL MODE  ↓
```

- ▶ Select **TERMINAL MODE** √ in the System menu and press OK again.

The automatic starting in **TERMINAL MODE** has been deactivated.

- ▶ Press ESC twice to return to the Status display.

8.2.5 Activating external buttons (**I-BUTTONS** and **R-BUTTONS** menu items)

The I pushbuttons and R pushbuttons options enable the operator to operate a MFD in a harsh environment by means of external function keys such as RMQ control circuit devices.



You can only activate one of the two I or R button options. Inputs that are activated as operating buttons are no longer available for control tasks in the circuit diagram.

External pushbuttons that are connected to the local I input terminals or the R input terminals of the expansion unit can thus take on the same functions as the operator buttons of the device. The I or R input terminals are permanently assigned to the function keys.

8 MFD Settings

8.2 System

Table 43: Assigning Operator Buttons and I or R Input Terminals

Operator Button	I-Input terminal	R-Input terminal
Cursor left	I1	R1
Cursor up	I2	R2
Cursor right	I3	R3
Cursor down	I4	R4
OK	I5	R5
ESC	I6	R6
DEL	I7	R7
ALT	I8	R8
* pushbutton (can only be assigned on a visualization device).	I9	R9

I9 on the 800 control relay can be used for control tasks.

The operator can produce the same effect as pressing the operator buttons (e.g. DEL+ALT) by pressing two buttons (e.g. I7+I8) simultaneously.

External pushbuttons and operator buttons of the device are evaluated at the same time thus enabling mixed operation.

In exceptional cases when the external pushbutton and the assigned operator button of the device are pressed simultaneously, the actuation of the external pushbutton is ignored. This excludes the possibility of contradictory operating states.

If an external pushbutton and an function key with different functions are pressed simultaneously, this is interpreted by the device as a button combination.

R PUSHBUTTONS

See the identical function description of the I buttons.

8.2.6 Setting contrast and backlight (DISPLAY menu item)

The backlight of the LCD display can be adjusted to one of 5 levels in order to suit local conditions.

Using the **Display backlight** button element enables the operator to change the backlight level during operation by pressing a button (→ Section "6.6.3 Display Backlight", from page 419). The backlight can also be changed in the program via the LE1 output operand.

The contrast of the display can be set to one of 17 stages.

When using an MFD-CP10... the use of the **Display contrast** button element enables the operator to change the contrast during operation via an operator button (→ Section "6.6.4 Display contrast", from page 420).

The contrast and backlight settings are device settings.

- ▶ Switch to the system menu.



If the MFD device is password protected, the System menu is only accessible after the MFD device has been unlocked (→ Section "8.1.4 Unlocking MFD", from page 448).

- ▶ In the system menu choose SYSTEM -> System-> DISPLAY and press OK.

```
CONTRAST: 0
LIGHTING: 75%
```

The menus for setting the contrast and backlight are displayed.

- ▶ Press the OK pushbutton and change the contrast setting.

```
CONTRAST: +1
LIGHTING 75%
```



- ▶ Use the cursor buttons ^ and v to set a contrast between -8 and +8 and press OK pushbutton to confirm the setting.

The contrast setting is valid until it is changed again.

```
CONTRAST: +1
LIGHTING 75%
```

- ▶ Use the cursor buttons ^ and v to move to the LIGHTING menu.
- ▶ Press OK.

```
CONTRAST: +1
LIGHTING 75%
```

- ▶ Use cursor buttons ^ and v to change the value in 25 % steps.
- ▶ Set the required backlighting.



The backlight changes immediately when the value is set. 0, 25, 50, 75 and 100% are possible values.

```
CONTRAST: +1
LIGHTING 100%
```



MFD device comes with the following factory setting:

- The contrast is set to 0.
- The backlight is permanently activated. Menu setting: LIGHTING √. The backlight is set to 75%.



MFD device comes with the following factory setting:

- The contrast is set to 0.
- The backlight is set to 75%.

8 MFD Settings

8.2 System

8.2.7 Storing data retentively (Retention menu item...)

Plant and machine controls require the possibility to retentively set operating states or actual values, i.e. the values should be retained safely even after the supply voltage of a machine or plant has been switched off and should be left unchanged until the actual value is overwritten.

The following operands and function blocks can be set to operate retentively:

- Markers.
- Counter function blocks.
- Data function block.
- Timing relays.

Hour meter

An MFD device is provided with 4 operating hours counters. These are always retentive and can be deleted specifically using a Reset command. Operating hours counters do not reduce the memory available for retentive data.

Memory for retentive data

The following table shows the maximum available memory for retentive data in the RAM.

Device	The maximum retentive memory [Byte]
MFD-CP8...	200
MFD-CP10...	400

Markers

The following table shows the maximum number of marker bytes that can be declared as retentive, with the limitation defined by the memory sizes stated above. The structure of the entire memory range is shown in → Table 25, page 154.

Device	Possible retentive marker bytes
MFD-CP8...	MB 01-MB96
MFD-CP10...	MB 01-MB192

Counter

All C., CH.. and CI.. function blocks can be operated with retentive actual values.

Data Function Blocks

A user-definable consistent function block DB.. range can be operated with retentive actual values.

Timing Relay

A user-definable and contiguous range for timing relays T.. can be run with retentive actual values.

Requirements:

In order to make data retentive, the relevant markers and function blocks must have been declared as retentive.

CAUTION

The retentive data is stored every time the power supply is switched off and read when the supply voltage is switched on. The data integrity of the memory is guaranteed for 10¹⁰ write-read cycles.

8.2.7.1 Setting retentive behavior

Requirement:

The MFD device must be in STOP mode.

- ▶ Press DEL and ALT simultaneously to switch from the Status display to the System menu.



If the MFD device is password protected, the System menu is only accessible after the MFD device has been unlocked (→ Section "8.1.4 Unlocking MFD", page 448).

The devices are factory set with no retentive actual value data selected. All actual values are therefore deleted if the MFD device is switched to STOP mode or de-energized.

```
RUN MODE      ✓ ↑
DEBOUNCE...
DISPLAY...
RETENTION...  ↓
```

- ▶ Switch to STOP mode.
- ▶ Switch to the system menu.
- ▶ Enter the system menu via STD PARAMETERS and then on to the RETENTION... menu.
- ▶ Press the OK button.

```
MB 00 -> MB 00 ↑
C 00 -> C 00
DB 00 -> DB 00 ↓
          B:200
```

The first screen that appears is a selection dialog for operand marker bytes (MB). The display on the lower right B:200 indicates the number of free bytes.

- ▶ Use ^v to select the operand.
- ▶ Press OK to access the Entry modes.
 - <> Select position from to.
 - ^v Set a value.

```
MB 01 -> MB 04
C 12 -> C 16
DB 01 -> DB 16
          B:076
```

- ▶ If necessary select the next operand.

In all, six different operand ranges can be selected.

Example:

MB 01 to MB 04, C 12 to C 16, DB 01 to DB 16, T 08 to T 14 should be retentive.

```
RETAIN MARKERS
T 08 -> T 14
```

8 MFD Settings

8.2 System

124 bytes have been assigned to the retentive data range. 76 bytes are still available.

- ▶ Select the RETAIN MARKERS option if you wish to retain the retentive actual values when transferring the circuit diagram from easySoft-Pro or the memory card to the MFD device.

Alternatively you can select the Retain markers during transfer option in easySoft-Pro.

- ▶ Save the entry from .. to .. with OK.

Press ESC to exit the input for the retentive ranges.

8.2.7.2 Deleting areas

Set the ranges to be erased to the values from 00 to 00.

e.g.: MB 00 -> MB 00. The markers are no longer retentive.

Deleting retentive actual values of markers and function blocks

The retentive actual values are cleared if the following is fulfilled (applies only in STOP mode):

- When the circuit diagram is transferred from easySoft-Pro (PC) or from the memory card to the MFD device, the retentive actual values are reset to 0. This does not occur if you have selected the Retain markers during transfer option in easySoft-Pro or activated the RETAIN MARKERS option on the device.
- When changing the respective retentive range.
- When the circuit diagram is deleted via the DELETE PROG menu.

8.2.7.3 Transferring retentive behavior

The retention setting is a circuit diagram setting and is carried with the program when it is transferred from the memory card or from easySoft-Pro.

8.2.7.4 Changing the operating mode or the circuit diagram

When the operating mode is changed or the MFD circuit diagram is modified, the retentive data is normally saved together with their actual values. The actual values of relays no longer being used are also retained.

8.2.7.5 Changing the operating mode

If you change from RUN to STOP and then back to RUN, the actual values of the retentive data will be retained.

8.2.7.6 Changing the MFD circuit diagram

The actual values are retained if the MFD circuit diagram is changed.

8.2.7.7 Changing the startup behavior in the SYSTEM menu

The retentive actual values are retained in MFD device regardless of the setting.

8.2.7.8 Modification of the retentive range

If the set retentive ranges are reduced, only the actual values saved in the range will remain.

If the retentive range is extended, the older data is retained. The new data is written with the current actual values in RUN mode.

8.3 Menu language

The MFD device provides 13 different menu languages:

8.3.1 Changing the menu language

You can change the menu language in the System menu.

Language	Display
English	ENGLISH
Deutsch	DEUTSCH
French	FRANÇAIS
Spanish	ESPAÑOL
Italian	ITALIANO
Portuguese	PORTUGUÊS
Dutch	NEDERLANDS
Swedish	SVENSKA
Polish	POLSKI
Turkish	TÜRKÇE
Hungarian	MAGYAR
Czech	ČESKY
Russian	РУССКИЙ



Language selection is only possible if the MFD device is not password-protected.

8 MFD Settings

8.4 Configurator

- ▶ Press DEL and ALT to call up the System menu.
- ▶ Select here the MENU LANGUAGE... for changing the language.

```
ENGLISH
DEUTSCH
FRANÇAIS
ESPAÑOL ↓
ITALIANO
PORTUGUÊS
NEDERLANDS
SVENSKA
POLSKI
TÜRKÇE
MAGYAR
ČESKY
РУССКИЙ
```

The language selection for the first entry ENGLISH is displayed.

- ▶ Use ^ or v to select the new menu language, e.g. French FRANÇAIS.
- ▶ Confirm with OK. FRANÇAIS is provided with a tick.
- ▶ Exit the menu with ESC.

```
SECURITE...
SYSTEMS...
LANGUE MENUS...
CONFIGURATEUR...
```

MFD device will now show the new menu language.

Press ESC to return to the Status display.

The menu language setting is a device function. This means that when the circuit diagram is deleted this does not result in the loss of the setting selected.

8.4 Configurator

Call the configurator in the System menu. The following menu items vary according to the device or the connected periphery.

8.4.1 NET

A description of how to parameterize and configure the easyNet network is provided in, → section "3.7 Commissioning NET stations", page 122.

8.4.2 COM

A description of how to parameterize and activate a COM-LINK, i.e. the point-to-point connection between an MFD and another device → Section "3.8.2.2 activate COM-LINK", page 134.

8.4.3 LINK

In this menu you assign parameters to a configurable local expansion unit that is connected to the easyLink terminal of the basic device. The menu is only accessible if this type of local expansion unit is connected.

The configurable expansion units include the communication expansion units such as EASY 204-DP and the EASY4.-DC-ME analog expansion units.

8.4.4 Configuring analog expansion units

How to configure analog expansion devices, → Section "3.6 Configuring the analog expansion unit", page 117.

8.4.5 Configure communication expansion unit

With a communication expansion unit you only configure the address via which it is to be accessed on the fieldbus. The AWA2528-.... for the expansion unit provides the relevant information.

8.4.6 ETHERNET-GW

This menu is used to assign parameters for an EASY209-SE Ethernet gateway that is connected to the serial multi-function interface.



An EASY209-SE Ethernet gateway can be run on a basic device from device version 08.

Basic requirements:

- The easy800 or MFD device must be in STOP operating mode.
- The device and the Ethernet gateway must be interconnected via an EASY800-MO-CAB or MFD-CP4-500-CAB5 connection cable.

The following table shows the available parameters and their factory settings for an Ethernet coupling unit.

The description of the parameters is provided in the operating manual for the Ethernet gateway AWB2528-1596., chapter Configuration via the RS232 interface and in the Help system of easySoft-Pro.

Table 44: Factory settings for an Ethernet coupling unit on easy800 or MFD

IP ADDRESS	0000.000.000.000
SUBNET-MASK	0000.000.000.000
GATEWAY-ADDRESS	0000.000.000.000 (standard gateway)
REMOTE-ADDRESS	0000.000.000.000
PORT-NUMBER	10001
REMOTE-PORT	00000
BAUD RATE	9600

8.4.7 IO MODULES

This menu is used to set the temperature module of the MFD which is fitted on the power supply unit/CPU module. Further information on this → Section "3.5 I/O module with temperature measuring", page 107.

8 MFD Settings

8.5 Setting time

8.5 Setting time

The MFD feature a real-time clock with date and time functionality. This allows the use of the time switch function blocks for implementing time switch functions.

8.5.1 Setting time and date

If the clock is not set or MFD device is switched on after the battery back-up time has elapsed, the clock starts with the setting WE 1:00 05/01/2002. The MFD clock operates with date and time so that hour, minute, day, month and year have to be set.

▶ Select SET CLOCK... from the main menu.
This will open the menu for setting the time.

▶ Choose SET CLOCK here.

```
SET CLOCK
SUMMER TIME
```

- ▶ Set the values for time, day, month and year.
- ▶ Press OK pushbutton to activate Entry mode:
- <> Select the position.
 - ^v Change the value of a parameter
 - OK: Save day and time
 - ESC: Retain previous setting.

```
HH:MM: 00:27
DD.MM: 05.05
YEAR : 2010
```

Press ESC to leave the time setting display.

8.5.2 Summer/winter time

The MFD devices are fitted with a real-time clock. These devices can be automatically switched between summer and winter time. These are subject to different legal requirements in the EU, GB and USA.

8.5.2.1 General



The DST setting you have defined is always linked with the program. When commissioning systems controlled by MFD for worldwide use it may be necessary to set and store this program also with the regional DST setting. For these kinds of MFD devices for worldwide use, use the "Rule" option for a DST setting.

The following options are available for setting DST parameters:

- NONE: No DST setting.
- MANUAL: User-defined daylight saving time setting.
- EU: Date for European Union; Start: Last Sunday in March; End: Last Sunday in October.

- GB: Select these options when using an **MFD-CP10...**
Start: Last Sunday in March; End Last Sunday in October.
When using an **MFD-CP8...**, select the EU option for the legally applicable time change for the United Kingdom since the GB option for this device stores the now obsolete rule.
This is as follows:
Start: Last Sunday in March; End: Fourth Sunday in October.

After the statutory settings have changed, the above rules for the European Union will also apply to the United Kingdom.

- US: Select these options when using an **MFD-CP10...**
When using an **MFD-CP8...**, set the Start and end of the DST time via the Rule... menu item or select the New Northern America DST rule supplied in easySoft for the currently applicable time change.
This rule is as follows:
Start - Second Sunday in March at 2:00 a.m. local time;
End - First Sunday in November at 2:00 a.m. local time.

On an MFD-CP8... the US option stores the following date according to the now obsolete rule:

Start: First Sunday in April; End: Last Sunday in October

- RULE: User-defined dates and changeover times as well as time difference selectable between 0 and 3 hrs; can be set in stages of 0.5 hrs.

8.5.2.2 Setting DST parameters

Select SET CLOCK... from the main menu and press OK.

```
SET CLOCK
SUMMER TIME
```

This will open the menu for setting the time.

- ▶ Select the DST menu and press OK.

The time change option is shown in the next menu.

Selecting the DST setting option

The standard setting is NONE for automatic DST changeover (✓ at NONE).

- ▶ Select the required option for the DST setting and press OK.

```
NONE      ✓ ↑
MANUAL
EU
GB        ↓
US
RULE
```

8 MFD Settings

8.5 Setting time

```
SUMMERTIME START
DD.MM: 01.01
SUMMERTIME END
DD.MM: 01:01
```

Manual option

To set your own date.

- ▶ Change to the MANUAL menu and press OK 2 x.
 - Select the position with <>.
 - Change the value with ^v.
 - Press OK to save day and time or press ESC to restore the previous setting.
- ▶ Press ESC to leave the display.
- ▶ Select the day and the month on which the summer time is to start.
- ▶ Select the day and the month on which the summer time is to end.

On the MFD-CP8... the time change always takes place in the subsequent years on the selected days, for example on each Sunday.

On the MFD-CP10... the time change always takes place in the subsequent years on the selected date, for example on the 30th of the month.



The same time for conversion applies as for the legally specified variants (EU, GB, US).

"EU", "GB" or "US" options

- ▶ Move to one of the EU, GB or US menus and press OK.
- ▶ Exit the menu with ESC.

The time setting is active and the MFD device switches to the following times according to these regional presets:

The following applies to the winter → summer time change with the regional presets EU, GB or US: On the changeover day the clock will switch from 2:00 to 3:00.

The following applies to the summer → winter time change with the regional presets EU, GB or US: On the changeover day the clock will switch back from 3:00 to 2:00.

Rule option



If you create a rule in the rule editor of the easySoft-Pro, you can access the national time scenarios provided on a row. These include possible worldwide time scenarios both for the northern and for the southern hemisphere. In special cases you can create your own special rules based on these.

```
SUMMERTIME START
SUMMERTIME END
```

- ▶ Change to the RULE menu and press OK.
- ▶ Choose SUMMERTIME START and press the OK button.

The flashing cursor is located in line 1, column 1 on the word ON.

```
ON LAST  SU
OF MONTH 03
AT 02:00
DIFF: + 1:00
```

- ▶ Press OK gain to move to Entry mode in order to set the changeover day parameters for summer time.
- ▶ Use cursor buttons ^ or v to set day 1 to 4 or the last day and press OK.
- ▶ Position the cursor in succession with the <> or ^v buttons at the required entry locations and change the Weekday parameter (SO), Month (OF xx. Month), Time (AT xx:xx) or the time difference (DIFF:) as previously described for the changeover day.
- ▶ Press ESC to exit the SUMMER TIME START and choose SUMMER TIME END.
- ▶ Set the changeover data to winter time as previously described for the changeover day to summer time and exit the menu with ESC.

The time difference (DIFF:) parameter corresponds to the entry for the changeover day to summer time and cannot be changed in this menu. The MFD device now alternates between summer and winter time according to your rule.

8 MFD Settings

8.5 Setting time

9 Inside MFD

9.1 MFD Program

In conventional control systems, a relay or contactor control processes all the rungs in parallel. The speed with which a contactor switches is thus dependent on the components used, and ranges from 15 to 40 ms for relay pick-up and drop-out.

With MFD the circuit diagram is processed with a microprocessor that simulates the contacts and relays of the circuit concerned and thus processes all switching operations considerably faster. Depending on its size, the circuit diagram is processed cyclically every 0.1 to 40 ms. During this time, the MFD device passes through six segments in succession.

If the operands of the inputs and outputs are addressed in the MFD, the signal states of the digital inputs/outputs are not scanned but a memory range in the device system memory is accessed. This memory range is called the process image. The process image is divided into two sections: the process image for the inputs and the process image for the outputs.

9.1.1 How the MFD device evaluates circuit diagrams and function blocks

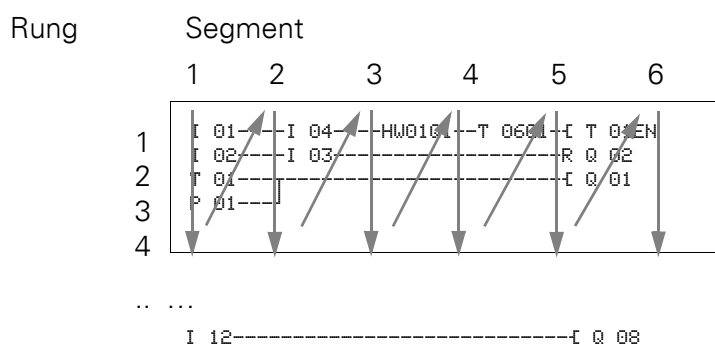

9.1.1.1 Segment 1 - 4

The MFD device evaluates the contact fields within the first four segments. The evaluation starts in the first segment in circuit diagram line 1 and continues from top to bottom until circuit diagram line n is reached. The MFD device then moves to the next contact segment and continues to evaluate from top to bottom until it has reached the last contact in the fourth segment. During this process it checks whether contacts are switched in parallel or in series and saves the switching states of all contact fields.

9 Inside MFD

9.1 MFD Program

9.1.1.2 Segment 5

In the fifth segment the MFD device assigns all coils in one pass, from the circuit diagram line 1 - n, with the new switch states from the process image of the outputs.

9.1.1.3 Segment 6

In the sixth segment which is outside of the circuit diagram, the function blocks present in the function block list are evaluated.

The MFD device uses this sixth segment in order to:

- process the existing function blocks.
The output data of a function block is immediately up-to-date after it has been processed.
The function blocks are processed by the MFD device in the order of the function block list (→ FUNCTION BLOCKS menu).

The following requirements must be fulfilled when using particular function blocks (→ section "9.1.4 Allowing for the special feature of certain function blocks", page 472).

- Contact the "outside world": Output relays Q 01 to Q... are switched and inputs I 1 to I... are re-read. For the expansion modules the S... output relays are switched and the R... inputs are read accordingly.
- to exchange easyNet data if this MFD device receives new read data or provides new send data (→ Section "7 The network easyNet" on page 469).
- to copy all new switch states to the status image.

The MFD device uses a fixed status image register that lasts for the duration of a cycle. This ensures that each rung is evaluated with the same switching states for one cycle, even if the input signals at I1 to I12, for example, change their status several times within a cycle.

9.1.2 Cycle-time monitoring

The device monitors the time required for a cycle to be completed.

If a fault causes the cycle time to exceed 1.05 s, the device switches the Q .. output relays to the safe state 0.

9.1.3 What you must consider when creating the circuit diagram

The MFD device evaluates the circuit diagram in segments, and from top to bottom within a segment, from circuit diagram line 1 - n. You should therefore remember two points when you create your circuit diagrams:

- The changeover of a relay coil does not change the switching state of an associated contact until the next cycle starts.
- Always wire forward or from top to bottom. Never work backwards.

9.1.3.1 Example: Self-latching with own contact

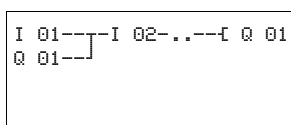

Start condition:

Inputs I 01 and I 02 are switched on.

Q 01 is switched off.

This is the circuit diagram of a self-latching circuit. If I 01 and I 02 are closed, the switching state of relay coil I Q 01 is "latched" via contact Q 01.

1st cycle: Inputs I 01 and I 02 are switched on. Coil Q 01 picks up.

Switching contact Q 01 remains off because the MFD device processes the circuit diagram segment for segment from top to bottom and from left to right from the first segment. By the time the MFD device refreshes the process image of the outputs and therefore the coil field with Q 01 in the fifth segment, contact field Q 01 in the second line of the circuit diagram has already been processed.

2nd cycle: The self-latching only now becomes active. The MFD device has transferred the coil states at the end of the first cycle to contact Q 01.

9.1.3.2 Example: Do not wire backwards

The following circuit diagram shows an example of why you should not wire backwards. In the third rung, the MFD device finds a connection to the second rung in which the first contact field is empty. The output relay is therefore not switched.

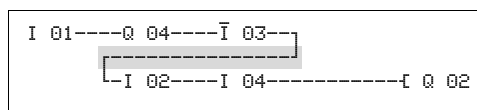

Figure 267: Circuit diagram with five contacts, invalid



Use one of the 96 auxiliary relays M..., if you have to connect more than four contacts in series.

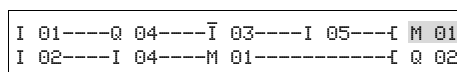

Figure 268: Circuit diagram with M 01 marker relay

9.1.4 Allowing for the special feature of certain function blocks

9.1.4.1 How the MFD device evaluates the high-speed counters CF, CH and CI

In order to evaluate the count pulses of up to 3 kHz, the high-speed counter function blocks operate with an interrupt routine. The length of the circuit diagram and the associated cycle time has no effect on the counter result.

9.1.4.2 Operating a DC or FT function block



The following has to be taken into account when operating a PID controller (DC) or a signal smoothing filter (FT):
The cycle time of the program must be less than the scan time of these function blocks. If the cycle time is greater than the scan time, these function blocks cannot supply any constant results.

9.1.5 What affects the cycle time of an MFD device

As well as the processing time required for the circuit diagram rungs and the function blocks in use, the cycle time of an MFD can also be influenced by the following factors.

9.1.5.1 Data exchange via COM-LINK

Data exchange via the COM-LINK point-to-point connection is possible in any segment of the cycle. This data exchange increases the cycle time both on the active and on the remote station. Only use those COM-LINK operands that are required.

9.1.5.2 Loading visualization data

When setting a program to RUN operating mode that contains visualization data, the contents of the screens to be displayed have to be loaded.

The time required for loading in the event of a mask change depends on the size of the masks to be loaded. The loading time can be calculated as follows:

Screen size in byte multiplied by 80 μ s.

Example: Screen size 250 bytes:

The loading time for the screen is: $250 \times 80 \mu\text{s} = 20 \text{ ms}$



The following applies if a short cycle time is required on the MFD: Use several small screens so that the loading time when changing screens is not too long. Only use the screens with content that is really necessary (→ Section "6.4.1 Screen memory" of page 370).

The loading of screen data and screen changes can be implemented in any segment of the program cycle. Take this behavior into account when considering the reaction time of your entire control system.



Distribute the tasks between several devices, which exchange data between each other via easyNet. Use MFD devices for open and closed loop control and other MFD devices for display and operation.

9.1.6 MFD memory management

The MFD is provided with a screen and program memory.

- Screen memory:
 - MFD-CP8..., 24 kByte
 - MFD-CP10..., 48 kByte

The screen memory stores the visualization data created with easySoft-Pro retentively.

- Program memory:
 - MFD-CP8..., 8 kByte
 - MFD-CP10..., 16 kByte

The program memory stores the program retentively.

9.1.6.1 Distribution of data in the program memory

MFD-CP8

During the runtime, the program memory stores the program, the retentive data and the screens to be displayed. The largest screen to be displayed reduces the memory available for the program.



The MFD-CP8 provides you with the largest possible memory for your program if you:

- only select the required retentive data bytes,
- create several smaller screens with fewer graphic elements instead of one large screen with several graphic elements (for example message bitmaps and bitmaps),
- reduce the size and number of graphic elements to what is necessary.

9 Inside MFD

9.2 Time behavior of the inputs and outputs

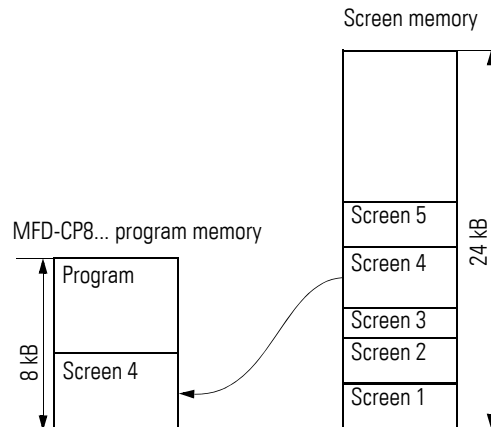

Figure 269: Division of program and screen memory on the MFD-CP8...

MFD-CP10...

During the runtime the program memory stores the program and the retentive data. The screen size does not have any effect on the program size.



The MFD-CP10... provides you with the largest possible memory for your program if you:

- observe the instructions stated for the MFD-CP8.. and
- only load the required download languages to the device.

9.2 Time behavior of the inputs and outputs

The reaction time, which is measured from the reading in of a digital input signal to the setting of the associated output, is determined by the timing characteristics of the device inputs and outputs as well as the size and design of the circuit diagram.

9.2.1 Input delay (debounce)

The time required from reading the inputs and outputs to switching the contacts in the circuit diagram can be increased on the MFD device using an input delay, the so-called DEBOUNCE, → Section "8.2.1 Switching on the input delay function (Debounce menu)", page 450.

This function is useful, for example, in order to ensure a clean switching signal despite contact bounce.

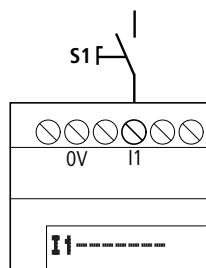

Figure 270: MFDinput assigned a switch

MFD DC and MFD AC units function with different input voltages and therefore also have different evaluation methods and delay times.

9.2.2 Delay time with MFD DC basic devices

Delay time with DEBOUNCE activated

When DEBOUNCE is activated, the delay time for DC signals is 20 ms.

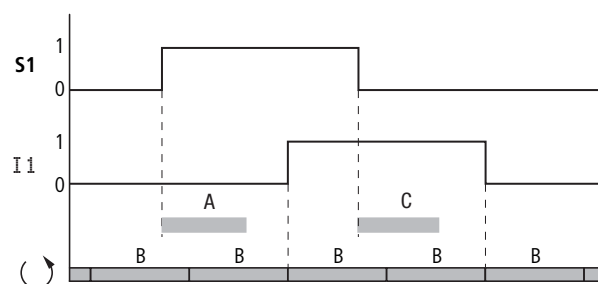

Figure 271: Delay times for evaluating an DC input signal and an activated DEBOUNCE

An input signal S1 must therefore be $> 15\text{ V}$ on the input terminal for at least 20 ms before the switch contact will change from 0 to 1 (A). If applicable, this time must also include the cycle time (B) since a MFD device does not detect the signal until the start of a cycle.

When the DC voltage signal drops out from 1 to 0 and DEBOUNCE is active, the same delay time (C) of 20 ms is applied before the signal is transferred to the next circuit diagram cycle.



When using high-speed counter function blocks, the delay time for the input signals must not exceed 0.025 ms. DEBOUNCE must therefore be deactivated.

9 Inside MFD

9.2 Time behavior of the inputs and outputs

Delay time with DEBOUNCE deactivated

When DEBOUNCE is deactivated, the typical delay time for DC signals on the input caused by the hardware lies between 0.025 ms and 0.25 ms (A). The cycle time (B) must be added as well before the signal is safely detected in the circuit diagram.

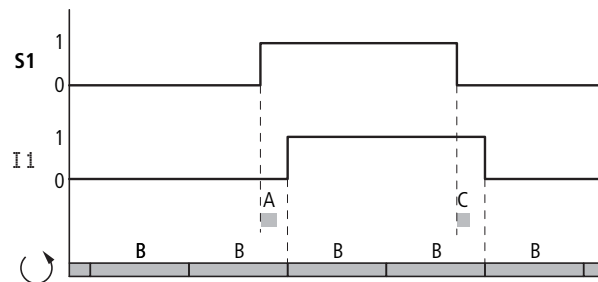

Figure 272: Switching behaviour with DEBOUNCE deactivated



When DEBOUNCE is deactivated ensure that input signals are free of noise. The MFD device responds to very short signals.



In order for an input signal to be detected and processed reliably, it must be stable for a minimum period which depends on the processing time (cycle time) of the circuit diagram.

Typical delay times with DEBOUNCE deactivated are:

- On-delay for:
 - I1 to I4: 0.025 ms
 - I5 to I12: 0.25 ms
- Off delay for:
 - I1 to I4: 0.025 ms
 - I5, I6 and I9 to I10: 0.4 ms
 - I7, I8, I11 and I12: 0.2 ms

9.2.3 Delay time with MFD AC basic devices

With AC inputs the MFD device scans the input signal in long or short scan cycles t_{SC} depending on whether DEBOUNCE is activated/deactivated. The scan cycle also depends on the frequency of the supply network.

Delay time with DEBOUNCE activated

If the DEBOUNCE function is activated, the MFD device checks whether a positive half-wave is present at an input terminal during two successive scan cycles t_{SC1} (1st and 2nd scan pulse at A). If the MFD device registers two positive half waves in succession, it switches the appropriate input (contact) internally from 0 to 1.

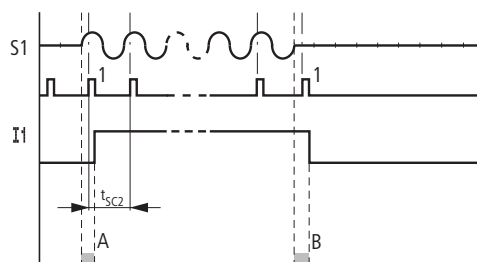

Figure 273: Delay times for evaluating an AC input signal and an activated DEBOUNCE

The typical input delay caused by the DEBOUNCE is therefore at least 80 ms. The cycle time must be added to this since an MFD does not transfer the signal into the circuit diagram until the start of a cycle. Conversely, the input is switched off if the MFD device does not detect any half-cycles twice in succession (1st and 2nd pulse at B).

t_{SC1} (50 Hz) = 40 ms, t_{SC} (60 Hz) = 33.3 ms

- Switch-on delay (normally):
 - I1...I12: 80 ms (66.7)
- Off-delay (normally):
 - I1...I12: 80 ms (66.7)

The corresponding values for 60 Hz are given in brackets.

Additional delay time due to bouncing pushbuttons

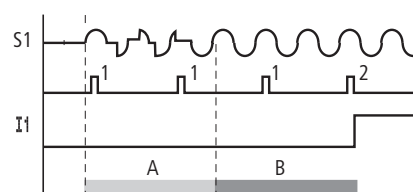

Figure 274: Pushbutton with bounce

If a pushbutton or switch bounces (A), the delay time may be extended by 20 ms (16.7 ms) (A).

Delay time with DEBOUNCE deactivated

If DEBOUNCE is deactivated, the delay time is reduced so that the MFD device switches the relevant input (contact) internally from 0 to 1 in shorter scan cycles t_{SC2} when a positive half-wave is detected.

9 Inside MFD

9.2 Time behavior of the inputs and outputs

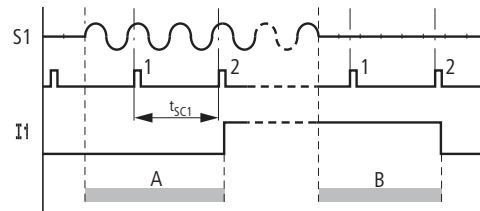

Figure 275: Switching behaviour with DEBOUNCE deactivated

If a positive half-cycle is not detected the MFD switches off the contact (B).

t_{SC2} (50 Hz) = 20 ms, t_{SC} (60 Hz) = 16.7 ms

- Switch-on delay (normally):
 - I1...I12: 20 ms (16.7)
- Off-delay (normally):
 - I1...I12: 20 ms (16.7)

The corresponding values for 60 Hz are given in brackets.



A description of how to modify the delay times is provided in the section (→ Section "9.2 Time behavior of the inputs and outputs", page 474).

9.3 Diagnostics

9.3.1 Diagnostics using the ID diagnostics contact

The MFD devices output information on their own operating state via ID diagnostics contacts. This information can be evaluated in the circuit diagram and shown on the display. To activate the display press the ALT pushbutton on the device twice from the Status display.



An I/O module with temperature measuring can be operated on MFD-CP8.. devices (DC) from device version number 08.

Diagnos- tics contact	Fault on 1 state
ID 01	Fault in easyNet station 1.
ID 02	Fault in easyNet station 2.
...	...
ID 07	Fault in easyNet station 7.
ID 08	Fault in easyNet station 8.
ID 09	Status of the activated COM-LINK connection
ID 10	Status of the internal connection between power supply/CPU module and I/O module with temperature measuring. Communication fault on 1 signal: Remedy: Check the plug connection between the visualization device and the I/O module with temperature measuring or replace the devices. ID10 and ID12 together in 1 state: See the description for ID12. If ID10 is set on its own or in combination, no measured values are transferred to the application and the analog output is reset.
ID 11	Status of I/O module with temperature measuring for both channels with wire break, short-circuit or out of range value. The temperature measuring values are invalid!
ID 12	Module conflict, parameterized I/O module and actually fitted module do not match. The MFD does not switch to RUN. ID12 is thus not evaluated in the program. You can check the state of ID12 in the display of the MFD or via the easySoft-Pro. The temperature measuring values are invalid!
ID 13	Free
ID 14	Fault in expansion unit
ID 15...16	Free
ID 17	Status of I/O module with temperature measuring: short-circuit at sensor 1 on 1 signal
ID 18	Status of I/O module with temperature measuring: wire break at sensor 1 on 1 signal.
ID 19	Status of I/O module with temperature measuring, status 1: actual value on sensor 1 below the set measuring range
ID 20	Status of I/O module with temperature measuring, status 1: actual value on sensor 1 above the set measuring range
ID 21	Status I/O module with temperature measuring: short-circuit on sensor 2 on 1 signal
ID 22	Status of I/O module with temperature measuring: wire break at sensor 2 on 1 signal.

Diagnosis contact	Fault on 1 state
ID 23	Status of I/O module with temperature measuring, status 1: actual value on sensor 2 below the set measuring range
ID 24	Status of I/O module with temperature measuring, status 1: actual value on sensor 2 above the set measuring range
ID 25...32	Free

9.3.2 Checking the transistor output for short-circuit/overload

To scan whether there is a short-circuit or an overload on an output of a device with transistor outputs, use the internal inputs I16, and use R15, R16 if an expansion unit is connected.

- MFD:
 - I16: Group fault alarm for outputs Q1 - Q4.
- EASY620-D.-TE (expansion unit):
 - R16: Group fault alarm for outputs S1 - S4.
 - R15: Group fault alarm for outputs S5 - S8.

Health	I16, R15 or R16
Fault alarms	
No fault present	0 = switched off (N/O)
Fault present on at least one output	1 = switched on (N/O)



I15 and I16 can only be used on MFD variants with transistor outputs.



I16 can only be used on MFD variants with transistor outputs.

The following examples show the use of the group fault alarm I16 for checking the function of the transistor outputs Q1...Q4.

9.3.2.1 Example 1: Output with fault indication

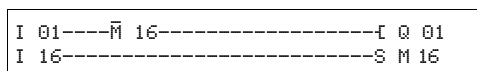

Figure 276: Circuit diagram for fault output via I16

The above circuit diagram functions as follows:

If a transistor output indicates a fault, I16 sets marker M16. The N/C of M16 switches off output Q1. M16 can be reset by switching the MFD supply voltage off and on so that the break contact closes again.

9.3.2.2 Example 2: Output of operating state

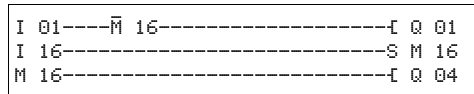

Figure 277: Output of operating state

The above circuit diagram operates as described in example 1. If an overload is detected, the indicator light at Q4 is also actuated. If Q4 had an overload, the light would pulse.

9.3.2.3 Example 3: Automatic reset of error signal

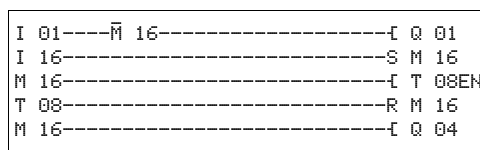

Figure 278: Automatic reset of error signal

The above circuit diagram has the same function as described in example 2. Timing relay T08 (on-delayed, 60 s) is also used to reset marker M16 every 60 s. If I16 is still at 1, M16 stays set. Output Q1 is set to 1 for a short time before I16 resets it again.

9.4 Expanding an MFD device

You can expand an MFD device using the easyLink network:

- Locally with expansion units EASY618-.-RE, EASY620-DC-TE, EASY410-DC-E, EASY406-DC-ME, EASY411-DC-ME, EASY202-RE.
- Remotely via the non-safety coupling module EASY200-EASY and one of the above mentioned easy600 expansions connected to it.

You can also use communication expansion units such as:

- EASY204-DP for PROFIBUS-DP.
- EASY221-CO for CANopen-Bus.
- EASY205-ASI for the Actuator-Sensor-Interface bus.
- EASY209-SE for Ethernet.
- EASY222-DN for DeviceNet.

Install the units and connect the inputs and outputs as described (→ Section "2.2 Mounting the expansion unit", page 54).

The inputs of the expansion units are processed in the circuit diagram of an MFD device as contacts like the inputs of the basic device. The input contacts are assigned the operand identifiers R1 to R12.

R15 and R16 are group fault alarms for the expansion units with transistor outputs (→ Section "9.7 Displaying device information", page 484).

9 Inside MFD

9.4 Expanding an MFD device

The outputs of the expansion units are processed as relay coils or contacts like the outputs in the basic device. The output relays are S1 to S8.



The EASY618-..-RE provides the outputs S1 to S6. The other outputs S7, S8 can be used internally.

9.4.1 How is an expansion unit detected?

If at least one R contact or contact/coil S is used in the circuit diagram, the basic device assumes that an expansion unit is connected.

9.4.2 easyLink transfer behavior

The input and output data of the expansion units is transferred via easyLink serially in both directions.

Take into account the longer response times of the inputs and outputs of expansion units compared to those of the basic device.

9.4.2.1 Response times of the inputs/outputs of the expansion units

The debounce setting has no effect on the expansion unit.

Transfer times for input and output signals:

- Local expansion
 - Time for inputs R1 to R12: 30 ms + 1 cycle.
 - Time for outputs S1 to S6 (S8): 15 ms + 1 cycle.
- Remote expansion
 - Time for inputs R1 to R12: 80 ms + 1 cycle.
 - Time for outputs S1 to S6 (S8): 40 ms + 1 cycle.

9.4.3 Monitoring the functionality of the expansion unit

If the power supply of the expansion unit is not present, no connection can be established between it and basic unit. The expansion inputs R1 to R12, R15, R16 are incorrectly processed in the basic unit and show status 0. The outputs S1 to S8 in the expansion device cannot be set.



DANGER

Ensure the continuous monitoring of MFD expansion units in order to prevent switching faults in machines or systems.

The status of the internal input I14 of the basic device signals the status of the expansion unit:

- I14 = 0: expansion unit is functional.
- I14 = 1: expansion unit is not functional.

Example:

The expansion unit may be powered up later than the basic device. This means that the basic device is switched to RUN when an expansion unit is missing. The following MFD circuit diagram detects if the expansion unit is ready for operation or not functional.

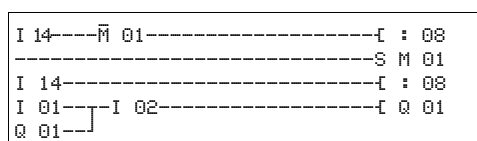

Figure 279: Circuit diagram for expansion testing

As long as I 14 is 1, the remaining circuit diagram is skipped. If I 14 is 0, the circuit diagram is processed. If the expansion unit drops out for any reason, the circuit diagram is skipped. M 01 detects whether the circuit diagram was processed for at least one cycle after the voltage supply is switched on. If the circuit diagram is skipped, all the outputs retain their previous state.

9.5 Monitoring the serial multi-function interface

The device runs a baud rate dependent timeout monitoring of the communication via the serial multi-function interface. If a data exchange in progress is interrupted for the set timeout time, the MFD device discards the data received up to this time and waits for a new start telegram.

Baud rate [kBit/s]	Timeout time [ms]
9.6	4000
19.2	3200
38.4	2400
57.6	2000

9.6 Monitoring the COM-LINK connection

The active MFD runs a baud rate dependent timeout monitoring of the communication via the serial multi-function interface. Information on the status of the connection is indicated by the local diagnostics bit ID09. You can query the diagnostics bit in the program of the active MFD.

9 Inside MFD

9.7 Displaying device information

Status of diagnostics bit ID09	Status of the connection
0	fault-free or COM-LINK not activated
1	Connection faulty

If the connection is faulty, the diagnostics bit indicates the status after a delay, the timeout time. The timeout time depends on the baud rate and on the event.

Type of fault	Baud rate [kBit/s]	Timeout time [ms]
CRC fault (incorrect Data)	9.6	250
	19.2	120
no response	9.6	1500
	19.2	800

CAUTION

If the diagnostics bit indicates a fault, the data received up to this time is discarded and the READ operands are set to zero. The diagnostics bit should therefore always be queried in the program and the receive data should not be used in the event of a fault.

The active MFD reattempts to start a data exchange after a fault is detected.

9.7 Displaying device information

The device information is provided for service tasks or in order to determine the performance level of the device.

This function is only available with devices featuring a display.



You can view the device information of devices without a display by using an MFD that is run in Terminal mode.

```
STOP ✓ RUN      ↑
PARAMETER
SET CLOCK
INFORMATION... ↓
TERMINAL MODE...
```

- ▶ Switch to the main menu and use the cursor button \wedge or \vee to move to the INFORMATION menu.
- ▶ Press OK.

This will display all device information:

Example: MFD-80-B, MFD-CP8-NT, MFD-TAP13-PT-A
Display STOP mode

```
DC TP13TC LC NT
OS : 1.11.111
CRC: 63163
```

Example: MFD-80-B, MFD-CP10-ME, MFD-TAP13-PT-A
Display RUN mode

```
DC TP13TC- LC --
OS : 1.00.128
CRC: ---
```

The CRC check sum is not displayed.

Line 1:

- DC/AC
 - AC (AC voltage)
 - or DC (DC voltage).
- TP12/TAP13
 - I/O module with temperature measuring
- TCA or TC-/RC
 - T: Transistor output,
 - or R: Relay output,
 - C: Real-time clock provided,
 - A: Analog output provided (reference letter not on temperature modules with analog output).
- LCD or LC/—
 - Display present/not present. This information can only be displayed by a locally connected MFD-CP4/-CP8 device in Terminal mode. If the remote device is run without a display, the MFD-CP4/-CP8 shows the dashes — at this position.
- NET or NT/—
 - easyNET connection present/not present.

Line 2:

- OS: e. g. 1.12.204, operating system version.

Line 3:

- CRC: e.g. 25825 (Checksum of the operating system is only displayed in STOP mode).
- Press ESC to exit the display.

9.8 Device Version Number

```
01-402110000404
```

```
DC 20.4 ...28.8 V
3 W
```

The device version number is shown on the back of the housing of each MFD device. These are the first two digits of the device number.

Example: 01-402110000404

This device is of device version 01.

With service requests, refer to the device version number for information about the hardware version and if necessary the version of the operating system.

9 Inside MFD

9.8 Device Version Number

10 What Happens If ...?

If a MFD does not behave as expected, the following tips can help you in rectifying any possible problems. If a program does not function as expected, in spite of a thorough simulation in easySoft-Pro, the power flow display in the MFD display enables you to test the logic operations of the circuit diagram.

Only qualified persons should test electrical voltages while the MFD is in operation.

10.1 Messages from the MFD operating system

Messages on the LCD display	Explanation	Remedy
No display	Power supply interrupted	Restore power supply
	LCD is faulty	MFD replace
Temporary display		
TEST: EEPROM	Only when switched on for the first time	-
TEST: CLOCK		
Continuous display		
ERROR: EEPROM	The memory for storing the retentive values or the MFD circuit diagram memory is faulty.	MFD replace
ERROR: CLOCK	Clock error	MFD replace

10 What Happens If ...?

10.2 Possible situations when creating circuit diagrams

10.2 Possible situations when creating circuit diagrams

Possible situations when creating circuit diagrams	Explanation	Remedy
Cannot enter contact or relay in circuit diagram	MFD is in RUN mode	Select STOP mode
Time switch switches at wrong times	Time or time switch parameters not correct	Check time and parameters
Message when using a memory card PROG INVALID	MFD memory card contains no circuit diagram Circuit diagram on the memory card uses contacts/relays that MFD does not recognise	Change MFD type or the circuit diagram on the memory card
Power flow display does not show changes to the rungs	MFD is in STOP mode	Select RUN mode
	Association/connection not fulfilled	Check and modify circuit diagram and parameter sets
	Relay does not activate coil	
	Incorrect parameter values/time	
	Analog value comparison is incorrect Time value of timing relay is incorrect Function of timing relay is incorrect	
Relay Q or M does not pick up	Relay coil has been wired up several times	Check coil field entries
Input not detected	Loose terminal contact	Check installation instructions, check external wiring
	No voltage to switch/button	
	Wire breakage	
	MFDInput is faulty	MFD replace
Relay output Q does not switch and activate the load	MFD is in operating mode STOP	Select RUN mode
	No voltage at relay contact	Check installation instructions, check external wiring
	MFD power supply interrupted	
	MFDcircuit diagram does not activate relay output	
	Wire breakage	
	MFDrelay is faulty	MFD replace

10.3 Event

Event	Explanation	Remedy
The actual values are not being stored retentively.	Retention has not been switched on.	Switch on retention in the SYSTEM menu.
The RETENTION... menu is not displayed in the SYSTEM menu.	MFD is in RUN mode	Select STOP mode
The SYSTEM menu is not displayed.	This MFD Type model does not have this menu.	MFD exchange if you need retention
MFD starts only in STOP mode	No circuit diagram in the MFD	Load, input circuit diagram
	RUN START is deactivated .	Activating RUN mode in Menu SYSTEM.
LCD display showing nothing.	No supply voltage	Switch on the supply voltage
	MFD defect	Press the OK button. If no menu appears, replace the MFD device.
	Text displayed with too many spaces	Enter text or do not activate text output
GW flashes on the Status display	EASY200-EASY bus coupler detected without I/O expansion	Connect I/O expansion to external easyLink

10.4 Functionality of the NET faulty

CAUTION

You can make a visual check the functionality of the NET by means of the NET LED and in the circuit diagram via diagnostics bit ID01-ID08.

Table 45: Checking the functionality of the NET using the NET LED

Status of the NET LED	Meaning
Off	NET not operational, fault in configuration
continuous light	NET station fault, possible causes: <ul style="list-style-type: none"> • Net is initialized and at least one station has not been detected. Check the plug-in connections. • You have modified the NET ID or baud rate for at least one station after the configuration has been completed. Change the configuration. • You have deleted the program on a NET station and thus also its NET configuration, → Page 127. Reconfigure the NET via station 1. • You have expanded an existing NET station and replaced it with a new device which cannot be assigned parameters.
Flashing	NET operating fault-free

10 What Happens If ...?

10.4 Functionality of the NET faulty

10.4.1 Monitoring via diagnostics bits

Diagnostic bits ID01 - ID08 (→ section “9.3 Diagnostics”, page 479) provide information on the presence or absence of NET stations. The state of the diagnostic bits is defined by the reception of a sign of life signal that every NET station sends.

If the sign of life signal of a configured NET station is no longer received, the diagnostics bit ID01 -ID08 for the missing NET station is immediately set to 1 for all remaining stations.

The sign of life signal is sent cyclically depending on the baud rate.

The presence of the configured NET stations is evaluated at the following time intervals:

Baud rate [kB]	Station must send a “sign of life” every ... [ms]	Station detects a missing sign of life signal from ... [ms]
1000	60	180
500	60	180
250	120	360
125	240	720
50	600	1800
20	1500	4500
10	3000	9000

If, for example, the station with NET ID 7 is missing, the diagnostics bit ID7 changes to 1 on every remaining NET station. The missing station is also indicated by means of a permanent light on the LED NET for all remaining NET stations.

CAUTION

In order to ensure that a circuit diagram with NET operands (e.g. 3GT01) is always working with the latest data, you should query the diagnostics bit ID.. of the sending NET station (see following example) before evaluating the operands. If you do not evaluate the appropriate diagnostics bit, this may cause malfunctions in your application.

Example of scanning the diagnostics bit ID..

```

ID03-----[:01
GT03Q1-----DB16T_
****
:01....
    
```

Figure 280: Scanning the diagnostics bit in the circuit diagram

■ = Visible area

Table 46: Reaction to missing sign of life signal on a NET station with or without a program.

Station with circuit diagram	NET station 1 detects the failure of a NET station 2...8 which is run without a circuit diagram: Input values received via nI.., nR.., nQ.., nS..nRN.. and GT are set to 0. The output values for this NET station are not changed.
Station without circuit diagram NET station with a NET ID 2...8 in REMOTE IO mode	The output values Q01 - Q08 and S01 - S08 received from NET station 1 are set to 0.



After the supply voltage is switched on, the other NET stations and NET stations of type MFD start up NET communication at different speeds. When these different types are used on a NET in mixed operation and are started simultaneously, a faster starting NET station will set its diagnostics contact ID.. = 1 to indicate a NET station of type MFD as missing.

Solution: On "all other NET stations" delay the evaluation of the diagnostics bit ID.. for the NET stations of type MFD by approx. 5 s by using the T function block (timing relay).

10.5 Replacing a NET station

If you wish to replace a NET station NT2 - NT8 in a running plant, you should take preparatory measures in order to ensure fault-free commissioning of this NET station.

Example

In a network run with a baud rate of 250 KB, the NET station NT7 is to be replaced.

If you are using an MFD device as a replacement, this device will not be integrated automatically into the network as it is not factory set with a NET-ID. Although the supply voltage is on and the NET connection is correct, the NET LED will remain off. It is then also not possible to load a program via the easySoft-Pro programming software (Communication View -> Device list box, NT7) into this replacement device.

The following procedure ensures fault-free commissioning of the replacement device.

- ▶ Connect the MFD replacement device to the supply voltage and connect it at the same position to the NET as the device to be replaced.
- ▶ Switch the device display of all NET stations to Status display.
- ▶ Start the automatic configuration of the NET, → section "3.7.2 Configuring NET", page 127 . However, you can also do this via the programming software. As an alternative to the automatic configuration, you can also switch the supply voltage of the configured NET stations off and on.

All NET stations in the NET configuration will temporarily switch to STOP.

10 What Happens If ...?

10.6 Power supply failure on station with NET-ID 1

10.6 Power supply failure on station with NET-ID 1

If the supply voltage of station NET-ID 1 fails during operation, the other NET stations can no longer be notified of the associated operating mode change.

NET stations with NET-ID 2 - 8 on which REMOTE RUN is activated therefore stay in RUN mode until the missing sign of life is detected. The time until the missing sign of life is detected depends on the baud rate and is from 180 - 9000 ms (→ Section "10.4.1 Monitoring via diagnostics bits" , page 490). Up to this time, a NET station 2 - 8 operates with the data previously received via the NET.

The further behavior of the NET stations 2 - 8 depends on whether REMOTE IO is also activated as well as REMOTE RUN:

- NET station 2 - 8 with activated REMOTE RUN

This type of NET station sets the data received via the NET to zero. It retains its operating state and sets the diagnostics bit ID1 to 1 (see following safety measure).

- NET stations 2 - 8 with activated REMOTE RUN and REMOTE IO that function as input/output devices, i.e. without their own circuit diagram

This type of NET station sets the data received via the NET to zero. It switches to the STOP mode if the device display is showing the Status menu. The device follows NET station 1 when it switches to RUN operating state.

Safety measure: On every NET station with a program, monitor the diagnostics bits ID.. in order to detect a missing NET station as quickly as possible (→ Section "10.4.1 Monitoring via diagnostics bits" , page 490).

11 Appendix

11.1 Approval and Certification

MFD devices are approved for use in several countries and regions as well as for operation on ships.

This also applies to expansion devices.

11.1.1 Approvals and national approvals for MFD devices

Product standards	<ul style="list-style-type: none"> • IEC/EN → section "11.3.1 Standards", page 499; • UL 508 (INDUSTRIAL CONTROL EQUIPMENT); • CSA C22.2 No. 142-M1987 (Process Control Equipment); • CSA C22.2 No. 213-M1987 (Non-Incendive Electrical Equipment for Use in Class I, Division 2 Hazardous Locations) • CE-mark
UL File No.	E135462
UL CCN	NRAQ
CSA File No.	012528
CSA Class No.	2252-01 + 2258-02 (for Hazardous Locations)
NA Certification	UL Listed, CSA certified
Protection type MFD-80-B Display/operating unit with keypad	IEC: IP65, in combination with MFD-XM-80; UL/CSA Type: 4X
Protection type MFD-80 Display/operating unit without keypad	IEC: IP65; UL/CSA Type: 4X
Protection type MFD-.- CP.-.- Power supply unit/CPU module	IEC: 20; UL/CSA Type : -
Protection type I/O modules	IEC: IP20; UL/CSA Type : -

MFD devices are approved for Russia, in accordance with GOST-R and for the Ukraine in accordance with Ukrain-GOST.

11.1.2 Shipping approvals for MFD devices

MFD	BV (Bureau Veritas)	DNV (DET NORSKE VERITAS)	GL (Germanischer Lloyd)	LR (Lloyds Register of Shipping)
Certificate number:	21608/A0 BV (without MFD-TP.../MFD-TAP...)	A-10620 (without MFD-TP.../MFD-TAP...)	24251- 04 HH (without MFD-TP.../MFD-TAP...)	04/20051 (without MFD-TP.../MFD-TAP...)

11 Appendix

11.1 Approval and Certification

11.1.3 Approvals and national approvals for expansion devices

Product standards	<ul style="list-style-type: none"> • IEC/EN → section "11.3.1 Standards", page 499; • UL 508 (INDUSTRIAL CONTROL EQUIPMENT); • CSA C22.2 No. 142-M1987 (Process Control Equipment); • CSA C22.2 No. 213-M1987 (Non-Incendive Electrical Equipment for Use in Class I, Division 2 Hazardous Locations) • CE-mark
UL File No.	E135462
UL CCN	NRAQ, NRAQ7
CSA File No.	012528
CSA Class No.	2252-01 + 2258-02 (for Hazardous Locations)
NA Certification	UL Listed, CSA certified
Protection type I/O modules	IEC: IP20; UL/CSA Type : -

Expansion devices are also approved for Russia, in accordance with GOST-R and for the Ukraine in accordance with Ukrain-GOST.

11.1.4 Shipping approvals for easy6.. expansion devices

easy6..	BV (Bureau Veritas)	DNV (DET NORSKE VERITAS)	GL (Germanischer Lloyd)	LR (Lloyds Register of Shipping)
Certificate number:	-	-	42991- 02 HH easy6..	02/20029 EASY618-..-RE

11.2 Dimensions

11.2.1 MFD-80.. display/operator unit

Front dimensions, W x H x D	
With pushbuttons [mm]	86.5 x 86.5 x 21.5
[inches]	3.41 x 3.41 x 0.85
Without pushbuttons [mm]	86.5 x 86.5 x 20
[inches]	3.41 x 3.41 x 0.79
Overall dimensions with fixing shaft, W x H x D	
With pushbuttons [mm]	86.5 x 86.5 x 43
[inches]	3.41 x 3.41 x 1.69
Thickness of fixing wall (without intermediate top-hat rail) Minimum; maximum	
[mm]	1; 6
[inches]	0.04; 0.24
Thickness of fixing wall (with intermediate top-hat rail) Minimum; maximum	
[mm]	1; 4
[inches]	0.04; 0.16
Weight	
[g]	130
[lb]	0.287
Mounting	
	2 22.5 mm (0.886 in) holes Display with two fixing rings Bolt-on
Maximum tightening torque of the fixing rings [Nm]	
	1.2 to 2

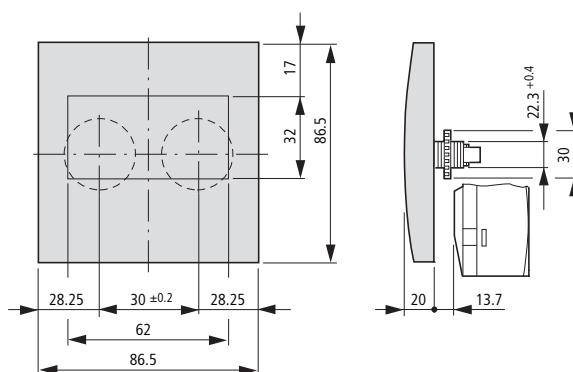

11 Appendix
 11.2 Dimensions

11.2.2 Power supply unit/CPU MFD-CP8...

Dimensions, W x H x D	
[mm]	107.5 x 90 x 30
[inches]	4.23 x 3.54 x 1.18
Weight	
[g]	145
[lb]	0.32
Mounting	<ul style="list-style-type: none"> • Plug-fitted to the display fixing shaft or • on the top-hat rail to DIN 50022, 35mm (without display) or • by means of fixing feet (without display)

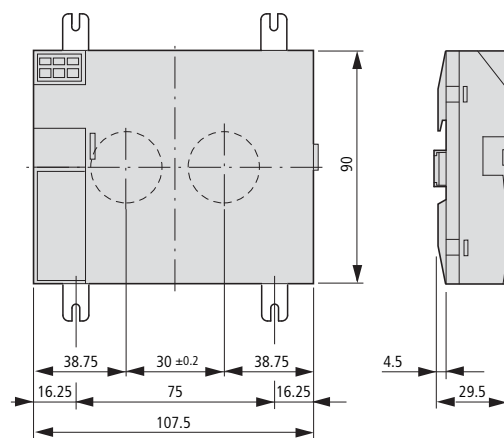

11.2.3 Input/output modules MFD-R.. , MFD-T..

Dimensions, when installed, W x H x D	
[mm]	89 x 90 x 25
[inches]	3.5 x 3.54 x 0.98
Dimensions, when removed, W x H x D	
[mm]	89 x 90 x 44
[inches]	3.5 x 3.54 x 1.73
Weight	
MFD-R..; MFD-T..[g]	150; 140
MFD-R..; MFD-T..[lb]	0.33; 0.31
Mounting	Snap fitted into the power supply module

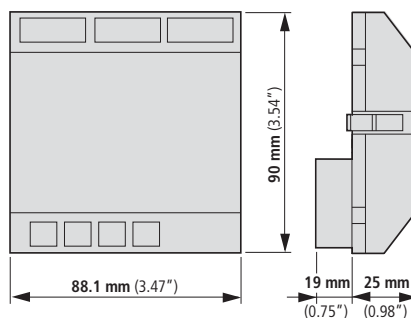

11.2.4 MFD-80-XM protective diaphragm

Dimensions, W x H x D	
[mm]	88 x 88 x 22.5
[inches]	3.46 x 3.46 x 0.98
Weight	
[g]	25
[lb]	0.055
Mounting	Is fitted over the display/function keys (with silver bezel)

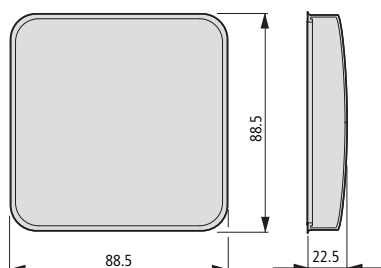

11 Appendix
11.2 Dimensions

11.2.5 MFD-80-XS protective cover

Dimensions, W x H x D	
[mm]	86.5 x 94 x 25
[inches]	3.41 x 3.41 x 0.98
Weight	
[g]	36
[lb]	0.079
Mounting	Is fitted over the display/function keys (without silver bezel)

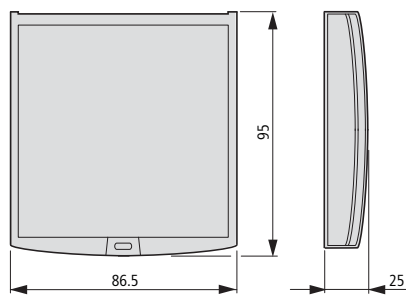

11.3 Technical data

11.3.1 Standards

	MFD
Standards	EN 55011, EN 55022, IEC EN 61000-4, IEC60068-2-6, IEC60068-2-27

11.3.2 General ambient conditions

Climatic conditions (damp heat constant to IEC 60068-2-78; cyclical to IEC 60068-2-30) (cold to IEC 60068-2-1, heat to IEC 60068-2-2)		
Operating ambient temperature Installed horizontally/vertically	°C, (°F)	–25 - 55, (–13 - 131)
Condensation (power supply unit/CPU; inputs/outputs)		Prevent condensation by means of suitable measures
Legibility of the display (–10 to 0 °C with back-lighting switched on, continuous duty)	°C, (°F)	–5 - 50, (23 - 122)
Storage/transport temperature	°C, (°F)	–40 - 70, (–40 - 158)
Relative humidity (IEC 60068-2-30), non-condensing	%	5 - 95
Air pressure (in operation)	hPa	795 - 1080
Ambient mechanical conditions		
Pollution degree		
Power supply unit/CPU; inputs/outputs		2
Display/operating unit		3
Protection type (EN 50178, IEC 60529, VBG4)		
Power supply unit/CPU; inputs/outputs		IP20
Display/operating unit		IP65, Type 3R, Type 12R
Display/operating unit with protective cover		IP65, Type 3R, Type 12R
Display/operating unit with protective diaphragm		IP65, NEMA Type 4X (Type 3R rain-tight and Type 12 dust-tight)
Vibration (IEC 60068-2-6)		
Constant amplitude 0.15 mm	Hz	10 - 57
Constant acceleration, 2 g	Hz	57 - 150
Shocks (IEC 60068-2-27) semi-sinusoidal 15 g/11 ms	Shocks	18
Drop (IEC 60068-2-31)	Drop height	mm
		50
Free fall, when packed (IEC 60068-2-32)	m	1
Electromagnetic compatibility (EMC)		
Electrostatic discharge (ESD), (IEC/EN 61000-4-2, severity level 3)		
Air discharge	kV	8
Contact discharge	kV	6

11 Appendix

11.3 Technical data

Electromagnetic fields (RFI), (IEC/EN 61000-4-3)	V/m	10
Radio interference suppression (EN 55011, EN 55022, IEC 61000-6-1, 2, 3, 4), limit class		B
Fast transient burst (IEC/EN 61000-4-4, severity level 3)		
Supply cables	kV	2
Signal cables	kV	2
High energy pulses (Surge) MFD (IEC/EN 61000-4-5, severity level 2), power cable symmetrical	kV	0.5
Line-conducted interference (IEC/EN 61000-4-6)	V	10
Insulation resistance		
Clearance in air and creepage distances		EN 50178, UL 508, CSA C22.2, No 142
Insulation resistance		EN 50178
Overvoltage category/pollution degree		II/2
Tools and cable cross-sections		
Solid, minimum to maximum	mm ²	0.2 - 4
	AWG	24 - 12
Flexible with ferrule, minimum to maximum	mm ²	0.2 - 2.5
	AWG	24 - 12
Slot-head screwdriver, width	mm	3.5 x 0.5
	inch	0.14 x 0.02

11.3.3 Display/operating unit

		MFD-80, MFD80-B
Power supply		
Power supply using power supply unit/CPU MFD-CP8..		
LCD display		
Type		Graphic/monochrome
Visible area W x H	mm	62 x 33
Size of pixels	mm	0.4 x 0.4
Number of pixels (W x H)		132 x 64
Spacing (pixel centre to pixel centre)	mm	0.42
LCD backlight		Yes
Backlight color		Yellow/green
Backlight can be switched on and off in the visualization application via LE1		Yes
LEDs		
Number of LEDs, can be used and programmed in visualization applications		2
Operator buttons		
Number		9
Can be used and programmed in visualization applications		9
Mechanical lifespan of pushbuttons	Operating elements	Normally 1 x 10 ⁶
Pushbutton illumination (LED)		
Number		5
Color		green

11.3.4 Power supply

11.3.4.1 AC Power supply

		MFD-AC-CP8...
Rated operational voltage		
Rated value (sinusoidal) U_e	V AC, (%)	100/110/115/120/230/240 AC (+10/-15)
permissible range	V AC	85 - 264
Frequency, tolerance	Hz (%)	50/60 (± 5)
Input current consumption		
At 115/120 V AC 60 Hz	mA	Normally 90
at 230/240 V AC 50 Hz	mA	part no. 60
Voltage dips, IEC/EN 61131-2	ms	10
Heat dissipation		
At 115/120 V AC	VA	part no. 11
at 230/240 V AC	VA	part no. 15

11.3.4.2 Voltage supply:DC

		MFD-CP8...
Rated operational voltage		
Rated value U_e	V DC, (%)	24 DC (-15/+20)
permissible range	V DC	20.4 - 28.8
Ripple	%	≤ 5
Input current		
For 24 V DC, MFD-CP8...	mA	part no. 125
for 24 V DC, MFD-CP8 + MFD80...	mA	part no. 250
at 24 V DC, MFD-CP8, MFD80... and MFD-R.../MFD-T...	mA	part no. 270
Voltage dips (IEC/EN 61131-2)	ms	10
Heat dissipation		
For 24 V DC, MFD-CP8...	W	part no. 3
for 24 V DC, MFD-CP8 + MFD80...	W	part no. 6
at 24 V DC, MFD-CP8, MFD80... and MFD-R.../MFD-T...	W	Normally 6.5
Fuse	CSA	$\geq 1 - \leq 4$

11.3.5 Central processing unit, real-time clock/timing relay/memory

A super capacitor or so-called double layer capacitor is provided to back up the power supply for the real-time clock.



The following charts show the backup time for a fully charged capacitor.

The full charge of the double layer capacitor is achieved if the MFD device has been connected to the power supply for 24 hours.

Back-up/accuracy of the MFD-CP8... real-time clock (see figure)

Back-up time

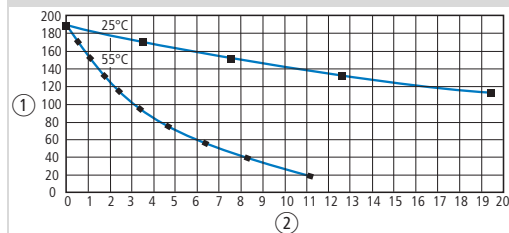

- ① Backup time (hours) with fully charged capacitor
- ② Service life (years)

Accuracy of the real-time clock s/day

Normally ± 2 (± 0.2 h/Year)
The accuracy of the real-time clock can vary, depending on the average ambient air temperature, up to ± 5 s/Day (± 0.5 h/Year).

Back-up/accuracy of the MFD-CP10... real-time clock (see figure)

Back-up time

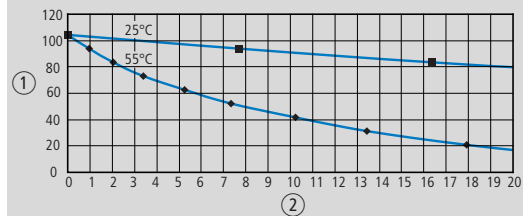

- ① Backup time (hours) with fully charged capacitor
- ② Service life (years)

Accuracy of the real-time clock s/day

Normally ± 0.17 (± 1 min/year, in an operating temperature range 0 °C - 40 °C, 32 °F - 104 °F)
The accuracy of the real-time clock can vary (2 min/year) depending on the operating ambient temperature range -25 °C - 55°C, 23 °F - 122 °F to ± 0.34 s/day .

11 Appendix

11.3 Technical data

Repetition accuracy of timing relays		
Accuracy of timing relay (of value) %		± 0.02
Resolution		
Range "S"	ms	5
Range "M:S"	s	1
Range "H:M"	min	1
Memory		
Possible Current paths		256
Possible contacts in series		4
Coil per circuit connection		1
Program memory MFD-CP8... for program/circuit diagram	KByte	8
Program memory MFD-CP10... for program/circuit diagram	KByte	16
MFD-CP8... screen memory (visualization)	KByte	24
MFD-CP10... screen memory (visualization)	KByte	48
Storage of programs (Zero-voltage safe, i.e. retentive)		FRAM
Retentive memory		
Size - MFD-CP8...	Byte	200
Size - MFD-CP10...	Byte	400
Operating Hours Counter	Byte	16
Write cycles of the retentive memory (minimum)		1000000000 (10 ⁹) (read/write cycles)

11.3.6 Inputs

11.3.6.1 Digital inputs 115/230 V AC

MFD-AC-R16			
Digital inputs 115/230 V AC			
Number			12
Status Display			LCD display (if provided)
Potential isolation			
from power supply			no
between digital inputs			no
from the outputs			Yes
to PC interface, memory card, network NET, easyLink			Yes
Rated voltage L (sinusoidal)			
at signal "0"		V AC	0 – 40
at signal "1"		V AC	79 – 264
Rated frequency		Hz	50 – 60
Input current at signal "1"			
I1 – I12		mA	12 x 0.2 (at 115 V AC, 60 Hz) 12 x 0.5 (at 230 V AC, 50 Hz)
Deceleration time			
Delay time (0→1/1→0) I1 – I12, 50/60 Hz			10 / 100
Max. admissible cable length (per input)			
I1 – I12		m	part no. 60

11.3.6.2 Digital inputs 24 V DC

			MFD-R(A)1..., MFD-T(A)1...	MFD-T(A)P...
Number				6
Inputs can be used as analog inputs				2 (I11, I12)
Status Display			via MFD80	via MFD80
Potential isolation				
from power supply			no	no
between digital inputs			no	no
from the outputs			Yes	Yes
to PC interface, memory card, easyLink			Yes	Yes
to network easyNet			Yes	Yes
Rated operational voltage	Ue	V DC	24	24
at signal "0"	Ue	V DC	< 5 (I1 – I6, I9, I10) < 8 (I7, I8, I11, I12)	< 5 (I1 – I4) < 8 (I11, I12)
at signal "1"	Ue	V DC	> 15.0 (I1 – I6, I9, I10), > 8.0 (I7, I8, I11, I12)	> 15.0 (I1 – I4), > 8.0 (I11, I12)
Input current at signal "1"				
I1 to I4		mA	–	3.3 (at 24 V DC)
		mA	3.3 (at 24 V DC)	–
I11, I12		mA	2.2 (at 24 V DC)	2.2 (at 24 V DC)
Hardware delay time „0“ -> „1“				
Debounce ON		ms	20	20
Debounce OFF		ms	Normally 0.025 (I1 – I4) normally 0.25 (I5, I6, I9, I10) normally 0.15 (I7, I8, I11, I12)	Normally 0.1 (I1 – I4) Normally 0.25 (I11 – I12)
Hardware delay time „1“ -> „0“				
Debounce ON		ms	20	20
Debounce OFF		ms	Normally 0.025 (I1 – I4) normally 0.25 (I5, I6, I9, I10), normally 0.15 (I7, I8, I11, I12)	normally 0.1 (I1 – I4), normally 0.2 (I11, I12)
Cable length (unscreened)		m	100	100
Rapid counter inputs				
Number			4 (I1, I2, I3, I4)	4 (I1, I2, I3, I4)
Cable length, shielded		m	20	20
High-speed up and down counter				
Counter frequency		kHz	≤ 3	≤ 3
Pulse shape			Square	Square
Pulse Pause Ratio			1:1	1:1

	MFD-R(A)1..., MFD-T(A)1...	MFD-T(A)P...
Frequency Counter		
Quantity	4 (I1, I2, I3, I4)	4 (I1, I2, I3, I4)
Counter frequency	kHz ≤ 3	≤ 3
Pulse shape	Square	Square
Pulse Pause Ratio	1:1	1:1
Incremental Encoder		
Number	2 (I1 + I2, I3 + I4)	2 (I1 + I2, I3 + I4)
Counter frequency	kHz ≤ 3	≤ 3
Pulse shape	Square	Square
Signal offset	90°	90°
Pulse Pause Ratio	1:1	1:1

11.3.6.3 Analog inputs

	MFD-R..., MFD-T...
Number	4 (I7, I8, I11, I12), for MFD-T(A)P: 2 (I11, I12)
Potential isolation	
from power supply	no
To the digital inputs	no
from the outputs	Yes
to PC interface, memory card, network NET, easyLink	Yes
Input type	DC voltage
Signal range	V DC 0 – 10
Resolution, analog	V 0.01
Resolution, digital	V 0.01
Resolution, digital	Bit 10 (value 0 – 1023)
Input impedance	kΩ 11.2
Accuracy of actual value	
two MFD devices	% ± 3
Within a single device	% ± 2
Conversion time, analog/digital	
Debounce ON:	ms 20
Debounce OFF	ms each CPU cycle
Input current	mA < 1
Cable length screened	m < 30

11.3.6.4 Analog inputs temperature monitoring and 0 - 10 V

		MFD-TP, MFD-TAP
Analog inputs temperature resistance Pt100 or Ni1000 sensors		
Number		2 x Pt100 or 2 x Ni1000 (according to type)
Input type resistance sensor		
Platinum sensor Pt100 according to DIN EN 60751, IEC 751		
Nickel sensor Ni1000 according to DIN 43760		
Temperature range		
Pt100, Range A, selectable	°C , (°F)	-40 to +90, (-40 to 194); 0 to 250, (32 to 482); 0 to 400, (32 to 752)
Ni1000, Range A, selectable	°C , (°F)	-40 to +90, (-40 to 194); 0 to 250, (32 to 482)
Pt100, Range B	°C , (°F)	0 to +850, (+32 to +1562); - 200 to +200, (-328 to +392)
Potential isolation		
from power supply		no
To the digital inputs		no
from the outputs		Yes
to PC interface, memory card, network NET, easyLink		Yes
Resolution digital, scaling per sensor		
With operands "IA" and "MD", selectable under scaling	Bit	12 (0 to 4095)
With operand "MD", selectable under scaling	°C, (°F)	1, 0.1; (1, 0.1)
Measurement value resolution analog/digital	Bit	Depending upon the scaling
Measuring current	mA	< 1.6
Damage limit (in the case of a wiring error)		Apply external voltage
Measurement method		Two or three wire per sensor, selectable by connection of sensor
Accuracy (without electromagnetic compatibility interference)		
Two MFD devices one above the other	%	Typically 1; maximal 1.6 (Pt); 1.2 (Ni)
Pt100-sensor (Offset error, linearity error, repetition accuracy, temperature dependency of the device included)	%	±0.8 of measurement range
Ni1000-sensor (Offset error, linearity error, repetition accuracy, temperature dependency of the device include)	%	±0.6 of measurement range
Conversion time, analog/digital		
Without sampling time setting, selectable per sensor	ms	200
With sampling time (adjustable), selectable per sensor	ms	200 to 65535

		MFD-TP, MFD-TAP
Additional measurement aids		
Filtering (Software), smoothing of analog input signals (PT1 behavior), only with set sampling time, selectable per sensor		Yes
Filter for the suppression of certain frequencies and their multiples	Hz	50, 60, 250, 500
Diagnostics		
Card diagnostic		Yes
Conductor or Wire break diagnostic per sensor		Yes
lower measurement range sensor undershot		Yes
Above upper measurement range		Yes
Cable length screened	m	< 10
Analog inputs 0 - 10 V of MFD-T(A)P (see above)		

11.3.6.5 Relay outputs

			MFD-R16, MFD-AC-R16
Number			4
Outputs in groups of			–
Parallel switching of outputs to increase performance			Not permissible
Protection of an output relay			Miniature circuit-breaker B16 or fuse 8 A (slow).
Potential isolation			
from power supply			Yes
from the inputs			Yes
to PC interface, memory card, network NET, easyLink			Yes
Safe isolation		V AC	300
Basic insulation		V AC	600
Lifespan, mechanical		Switch operations	10x 10 ⁶
Contacts			
conventional thermal current (UL/CSA)		CSA	8 (10)
Recommended for load: 12 V AC/DC		mA	> 500
short-circuit proof $\cos \varphi = 1$, characteristic B16 at 600 A		CSA	16
Short-circuit proof $\cos \varphi = 0.5 - 0.7$; characteristic B16 at 900 A		CSA	16
Rated impulse withstand voltage $U_{i\text{imp}}$ contact coil		kV	6
Rated operating voltage U_e		V AC	250
Rated insulation voltage U_i		V AC	250
Safe isolation to EN 50178 between coil and contact		V AC	300
Safe isolation to EN 50178 between two contacts		V AC	300
Making capacity, IEC 60947			
AC—15, 250 V AC, 3 A (600 ops./h)		Switch operations	300000
DC-13, L/R \leq 150 ms, 24 V DC, 1 A (500 S/h)		Switch operations	200000
Breaking capacity, IEC 60947			
AC—15, 250 V AC, 3 A (600 ops./h)		Switch operations	300000
DC-13, L/R \leq 150 ms, 24 V DC, 1 A (500 S/h)		Switch operations	200000

			MFD-R16, MFD-AC-R16
Filament bulb load			
1000 W at 230/240 V AC		Switch operations	25000
500 W at 115/120 V AC		Switch operations	25000
Fluorescent lamp load			
Fluorescent lamp load 10 x 58 W at 230/240 V AC			
With series-connected electrical device		Switch operations	25000
Uncompensated		Switch operations	25000
Fluorescent lamp load 1 x 58 W at 230/240 V AC, conventionally compensated			
		Switch operations	25000
Switching Frequency			
mechanical operations		Switch operations	10x 10 ⁶
Switching Frequency		Hz	10
Resistive load/lamp load		Hz	2
Inductive load		Hz	0.5
UL/CSA			
Continuous current at 240 V AC		CSA	10
AC			
Control circuit rating codes (utilization category)			B 300 Light Pilot Duty
Max. rated operational voltage		V AC	300
max. thermal continuous current cos φ = 1 at B 300		CSA	5
max. make/break cos φ \neq capacity 1 at B 300		VA	3600/360
DC			
Control circuit rating codes (utilization category)			R 300 Light Pilot Duty
Max. rated operational voltage		V DC	300
Max. thermal continuous current at R 300		CSA	1
Max. make/break capacity at R 300		VA	28/28

11.3.6.6 Transistor outputs

			MFD-T...
Number			4
Rated operational voltage	U _e	V DC	24
permissible range	U _e	V DC	20.4 – 28.8
Ripple		%	≤ 5
Supply current			
at signal "0"	typ./max.	mA	18/32
at signal "1"	typ./max.	mA	24/44
Protection against polarity reversal Caution!			yes
If voltage is applied to the outputs when the polarity of the supply voltage is reversed, this will result in a short-circuit.			
Potential isolation			
from power supply			Yes
from the inputs			Yes
to PC interface, memory card, network NET, easyLink			Yes
Rated operational current at signal "1", maximum	I _e	CSA	0.5
Lamp load without R _V		W	5 (Q1 – Q4)
Residual current at signal "0" per channel		mA	< 0.1
Max. output voltage			
With condition "0" at external load < 10 MΩ		V	2.5
with condition "1" at I _e = 0.5 A		V	U = U _e - 1 V
Short-circuit protection thermal (Q1 to Q4), (carry out evaluation via diagnostics input I16).			Yes
Short-circuit tripping current for R _a ≤ 10 mΩ (depending on number of active channels and their load)		CSA	0.7 ≤ I _e ≤ 2 per output
Maximum, total short-circuit current		CSA	8
Peak short-circuit current		CSA	16
Thermal cutout			Yes
max. operating frequency at constant resistive load R _L < 100 kΩ (dependant on program and load)		Operat ions/h	40000
Parallel connection of outputs			Yes
with resistive load, with inductive load with external suppressor circuit (see section Connecting transistor outputs), with combination within a group			Group 1: Q1 to Q4

		MFD-T...
Number of outputs (max.)		4
Max. total current Caution!	CSA	2
Outputs must be actuated simultaneously and for the same time duration.		
Status indication of the outputs		LCD display (if provided)

Inductive load without external suppressor circuit

General explanations: $T_{0.95}$ = time in milliseconds until 95 % of the stationary current is reached

$$T_{0.95} \approx 3 \times T_{0.65} = 3 \times \frac{L}{R}$$

Utilization category in groups for

- Q1 to Q4, Q5 to Q8

$T_{0.95} = 1 \text{ ms}$ $R = 48 \ \Omega$ $L = 16 \text{ mH}$	Utilization factor per group $g =$		0.25
	Relative duty factor	%	100
	Max. switching frequency $f = 0.5 \text{ Hz}$ Max. duty factor DF = 50 %	Switching operation s/h	1500
DC13 $T_{0.95} = 72 \text{ ms}$ $R = 48 \ \Omega$ $L = 1.15 \text{ H}$	Simultaneity factor $g =$		0.25
	Relative duty factor	%	100
	Max. switching frequency $f = 0.5 \text{ Hz}$ Max. duty factor DF = 50 %	Switching operation s/h	1500

Other inductive loads:

$T_{0.95} = 15 \text{ ms}$ $R = 48 \ \Omega$ $L = 0.24 \text{ H}$	Simultaneity factor $g =$		0.25
	Relative duty factor	%	100
	Max. switching frequency $f = 0.5 \text{ Hz}$ Max. duty factor DF = 50 %	Switch operation s/h	1500
Inductive loading with external suppressor circuit for each load (→ Section "2.6.2 Connecting digital transistor outputs", page 78)			
Simultaneity factor $g =$			1
Relative duty factor		%	100
Max. switching frequency Max. duty factor		Switch operation s/h	Depending on the suppressor circuit

11.3.7 Analog output

			MFD-RA17, MFD-TA...
Quantity			1
Potential isolation			
from power supply			no
To the digital inputs			no
From the digital outputs			Yes
to PC interface, memory card, network NET, easyLink			Yes
Output type			DC voltage
Signal range		V DC	0 – 10
Max. output current		CSA	0.01
Load resistance			1 kΩ
Overload and short-circuit protection			Yes
Resolution, analog		V DC	0.01
Resolution, digital		Bit	MFD-TAP: 12 (0 - 4095) at QA01, MD
Recovery time		μs	100
Accuracy			
-25 °C – 55 °C		%	2
25C		%	1
Conversion time, analog/digital		ms	each CPU cycle

11.3.8 NET easynetwork

		MFD-...-NT
Number of stations		8
Bus length/transmission speed ¹⁾	m/Kbaud	6/1 000 25/500 40/250 125/125 300/50 700/20 1 000/10
Potential isolation		
To power supply, inputs, outputs, easyLink, PC interface, memory module		Yes
Bus termination (→ accessories)		
First and last station		Yes
Plug connector (→ accessories)	poles	8
Type		RJ45
Cable cross-sections, with cable lengths and cable resistance/m		
Cross-section up to 1 000, < 16 mΩ/m	mm ² (AWG)	1.5 (16)
Cross-section up to 600, < 26 mΩ/m	mm ² (AWG)	0.75 to 0.8 (18)
Cross-section up to 600, < 26 mΩ/m	mm ² (AWG)	0.5 to 0.6 (20, 19)
Cross-section up to 400 m, < 40 mΩ/m	mm ² (AWG)	0.34 to 0.5 (22, 21, 20)
Cross-section up to 250 m, < 60 mΩ/m	mm ² (AWG)	0.25 to 0.34 (23, 22)
Cross-section up to 175 m, < 70 mΩ/m	mm ² (AWG)	0.13 (26)
Cross-section up to 40 m, < 140 mΩ/m	mm ² (AWG)	1.5 (16)

1) Bus lengths above 40 m can only be achieved with cables with reinforced cross-section and connection adapter.

11 Appendix

11.4 List of function blocks

11.4 List of function blocks

Function block	Meaning of abbreviation	Function block designation	Page	From dev. vers. no.
CSA	Analog value comparator	Analog value comparator	199	01
AR	Arithmetic	Arithmetic	204	01
BC	Block Compare	Data block comparator	208	01
BT	Block Transfer	Data block transfer	216	01
BV	Boolean operation	Boolean operation	228	01
C	Counter	Counter	232	01
CF	Counter Frequency	Frequency Counter	238	01
CH	Counter High Speed	High-speed counters	243	01
CI	Counter fast Incremental Value Encoder	High-speed incremental value counter	249	01
CP	Comparators	Comparator	255	01
DB	Data Block	Data Function Block	258	01
DC	DDC controller (direct Digital Control)	PID Controller	261	01
FT	Filter	PT1 Signal Smoothing Filter	268	01
GT	GET	GET (Value from NET)	273	01
HW	Hora _(lat) Week	Weekly timer	276	01
HY	Hora _(lat) Year	Year time switch	282	01
JC	Jump Conditional	Conditional Jump	291	05
LB	Label	Jump label	294	05
LS	Linear Scaling	Value Scaling	295	01
MR	Master Reset	Master Reset	300	01
MX	Multiplexer	Data multiplexer	303	MFD-CP10..
NC	Numeric Coding	Numerical Converter	307	01
OT	Operating Time	Operating Hours Counter	312	01
PT	PUT	PUT (Value on NET)	315	01
PW	Pulse Width Modulation	Pulse Width Modulation	319	01
SC	Synchronize Clocks	Synchronize clock via NET	323	01
SR	Shift Register	Shift Register	325	05
ST	Set Time	Set cycle time	337	01
T	Timing relays	Timing Relay	340	01
TB	Table function	Table Function	350	05
VC	Value Capsuling	Value Limit	355	01

11.4.1 Function block coils

The following table is a general overview of the function block contacts. A detailed overview of all contacts used in the circuit diagram is provided in → Section "11.5 Memory requirement" on page 520.

Table 47: General overview of the function block coils

Coil	Meaning of abbreviation	Description
BD	Backward Direction	Bit data input, backwards shift direction
BP	Backward Pulse	Trigger coil Clock input, backward shift direction
C_	Count input	Counter input
D_	Direction input	Count Direction
ED	Enable Differential Ratio	Activate differential component
EI	Enable Integral Ratio	Activate integral component
EN	Enable	Enable function block
EP	Enable Proportional component	Activate proportional component
FD	Forward Direction	Bit data input, forwards shift direction
FP	Forward Pulse	Trigger coil Clock input, forward shift direction
RE	Reset	Reset actual value to zero
RF	Read First	Trigger coil On detecting a rising edge (trigger) and EN = 1 the oldest value entered in the table is read out and supplied at output QV (FIFO function)
RL	Read Last	Trigger coil On detecting a rising edge (trigger) and EN = 1 the newest value entered in the table is read out and output at output QV (LIFO function)
SE	Set Enable	Set to a predefined value
ST	Stop	Stop block processing
T_	Trigger	Trigger coil for starting the timing relay
WP	Word Pulse	Trigger coil On detecting a rising edge (trigger) and EN = 1 the value is entered in the table

11 Appendix

11.4 List of function blocks

11.4.2 Function block contacts

The following table is a general overview of the function block contacts. A detailed overview of all contacts used in the circuit diagram is provided in → Section "11.5 Memory requirement" on page 520.

Table 48: General overview of the function block contacts

Contact	Meaning of abbreviation	Description
AC	Active	Status 1, as long as the input value has been buffered but not yet transferred to the easyNet with the PUT function block.
CY	Carry	Status 1, if the value range is exceeded
E1	Error 1	Error 1, dependent on function block
E2	Error 2	Error 2, dependent on function block
E3	Error 3	Error 3, dependent on function block
EQ	Equal	Comparison result, status 1 if values equal.
FB	Fall Below	Status 1, if the actual value is less than or equal to the lower setpoint value
GT	Greater Than	Status 1 if the value at I1 > I2
LI	Limit Indicator	Value range manipulated variable exceeded
LT	Less Than	Status 1 if the value at I1 < I2;
OF	Overflow	Status 1, if the actual value is greater than or equal to the upper setpoint value;
q	Output (Q...)	Switch output
QV	Output Value	Current actual value of the function block (e.g. counter value);
Space units	Table Empty	Status 1 if the table is empty
TF	Table Full	Status 1 if the table is full
ZE	Zero	Status 1, if the value of the element input QV is equal to zero;

11.4.3 Function block inputs (constants, operands)

Input	Meaning of abbreviation	Description
BF	Standard	Frequency change in braking phase
F1	Factor 1	Gain factor for I1 ($I1 = F1 \times \text{Value}$)
F2	Factor 2	Gain factor for I2 ($I2 = F2 \times \text{Value}$)
FO	Frequency Operation	Operating Frequency
FS	Frequency Start	Start Frequency
HY	HYsteresis	Switching hysteresis for value I2 (Value HY applies to positive and negative hysteresis.)
I1...I8	Input 1 to Input 8	1. to 8. input word
KP	Channel	Channel number Value range: 0...7
KP	Standard	Proportional Gain
ME	Minimum make time	Minimum make time
MV	Manual Value	Manual manipulated variable
NO	Numbers Of elements	Number of elements
OS	OffSet	Offset for the value I1
PI	Standard	Number of steps in Jog mode
PF	Standard	Frequency in jog mode
PD	Period of Duration	Period Duration
RF	Standard	Frequency change in acceleration phase
SH	Setpoint High	Upper Limit Value
SL	Setpoint Low	Lower Limit Value
SV	Set Value	Defined actual value (Preset)
TC	Standard	Scan Time
TG	Standard	Recovery time
TN	Standard	Derivate time
TV	Standard	Reset time
X1	X1, interpolation point 1 abscissa	Lower value of source range
X2	Interpolation point 2 abscissa	Upper value of source range
Y1	Interpolation point 1 ordinate	Lower value of target range
Y2	Interpolation point 2 ordinate	Upper value of target range

11 Appendix

11.5 Memory requirement

11.4.4 Function block output (operands)

Output	Meaning of abbreviation	Description
D1...D8	Data 1...8	Output values
QN	Output Number	Number of table entries present, 0...16
QV	Output Value	Output value

11.4.5 Other operands

Other operands	Meaning of abbreviation	Description
MB	Marker byte	8-Bit value
IA	Input Analog	Analog input (if available on device!)
MW	Marker Word	16-Bit value
QA	Output Analog	Analog output (if present on the device!)
MD	Marker Double Word	32-Bit value
NU	NUmber	Constant, value range from -2147483648 to +2147483647

11.5 Memory requirement

The following table serves as an overview of the memory requirement of the for rungs, function blocks and their associated constants.



Avoid empty rungs dispersed between written rungs after operands have been deleted. These kinds of empty rungs take up just as much space as a written rung.

	Space requirement per rung/ function block Byte	Space requirement per constant at function block input Byte
Rung	20	–
Function Blocks		
CSA	68	4
AR	40	4
BC	48	4
BT	48	4
BV	40	4
C	52	4
CF	40	4
CH	52	4
CI	52	4
CP	32	4

11 Appendix
11.5 Memory requirement

	Space requirement per rung/ function block Byte	Space requirement per constant at function block input Byte
DB	36	4
DC	96	4
FT	56	4
GT	28	-
HW	68	4 (per channel)
HY	68	4 (per channel)
JC	20	-
LB	-	-
LS	64	4
MR	20	-
MX MFD-CP10...	96	4
NC	32	4
OT	36	4
PT	36	4
PW	48	4
SC	20	-
SR	96	4
ST	24	4
T	48	4
TB	112	4
VC	40	4
:	-	-

11 Appendix

11.6 Basic and extended Western European character set

11.6 Basic and extended Western European character set

Table 49: Western European basic character set

Unicode (hex)	Character	Unicode (hex)	Character	Unicode (hex)	Character	Unicode (hex)	Character
U+0020		U+0040	@	U+0060	`		
U+0021	!	U+0041	CSA	U+0061	a	U+00A1	¡
U+0022	"	U+0042	B	U+0062	b	U+00A2	¢
U+0023	#	U+0043	C	U+0063	c	U+00A3	£
U+0024	\$	U+0044	D	U+0064	d		
U+0025	%	U+0045	E	U+0065	e	U+00A6	¦
U+0026	&	U+0046	F	U+0066	f	U+00A9	©
U+0027	'	U+0047	G	U+0067	g		
U+0028	(U+0048	H	U+0068	h	U+00B0	°
U+0029)	U+0049	I	U+0069	i	U+00B1	±
U+002A	*	U+004A	J	U+006A	j	U+00B2	²
U+002B	+	U+004B	KP	U+006B	k	U+00B3	³
U+002C	,	U+004C	L	U+006C	l	U+00B4	´
U+002D	-	U+004D	M	U+006D	m	U+00B5	µ
U+002E	.	U+004E	N	U+006E	n		
U+002F	/	U+004F	O	U+006F	o	U+00BF	¿
U+0030	0	U+0050	KP	U+0070	p		
U+0031	1	U+0051	q	U+0071	q	U+201E	„
U+0032	2	U+0052	R	U+0072	r	U+2030	‰
U+0033	3	U+0053	S	U+0073	s	U+20AC	€
U+0034	4	U+0054	T	U+0074	t	U+2190	←
U+0035	5	U+0055	U	U+0075	u	U+2191	↑
U+0036	6	U+0056	V	U+0076	v	U+2192	→
U+0037	7	U+0057	W	U+0077	w	U+2193	↓
U+0038	8	U+0058	X	U+0078	x	U+2194	↔
U+0039	9	U+0059	Y	U+0079	y	U+2195	↕
U+003A	:	U+005A	Z	U+007A	z	U+2264	≤
U+003B	;	U+005B	[U+007B	{	U+2265	≥
U+003C	<	U+005C	\	U+007C		U+2588	■
U+003D	=	U+005D]	U+007D	}	U+25A0	■
U+003E	>	U+005E	^	U+007E	~	U+25A1	□
U+003F	?	U+005F	_	U+007F		U+25AA	▪

11.6 Basic and extended Western European character set

Table 50: Extension of the Western European basic character set

Unicode (hex)	Character	Unicode (hex)	Character	Unicode (hex)	Character	Unicode (hex)	Character
U+00C0	À	U+00E0	à				
U+00C1	Á	U+00E1	á				
U+00C2	Â	U+00E2	â	U+0152	Œ		
U+00C3	Ã	U+00E3	ã	U+0153	œ		
U+00C4	Ä	U+00E4	ä				
U+00C5	Å	U+00E5	å	U+0160	Š		
U+00C6	Æ	U+00E6	æ	U+0161	š		
U+00C7	Ç	U+00E7	ç				
U+00C8	È	U+00E8	è	U+0178	ÿ		
U+00C9	É	U+00E9	é	U+017D	Ž		
U+00CA	Ê	U+00EA	ê	U+017E	ž		
U+00CB	Ë	U+00EB	ë				
U+00CC	Ì	U+00EC	ì				
U+00CD	Í	U+00ED	í				
U+00CE	Î	U+00EE	î				
U+00CF	Ï	U+00EF	ï				
U+00D0	Ð	U+00F0	ð				
U+00D1	Ñ	U+00F1	ñ				
U+00D2	Ò	U+00F2	ò				
U+00D3	Ó	U+00F3	ó				
U+00D4	Ô	U+00F4	ô				
U+00D5	Õ	U+00F5	õ				
U+00D6	Ö	U+00F6	ö				
U+00D7		U+00F7					
U+00D8	Ø	U+00F8	ø				
U+00D9	Ù	U+00F9	ù				
U+00DA	Ú	U+00FA	ú				
U+00DB	Û	U+00FB	û				
U+00DC	Ü	U+00FC	ü				
U+00DD	Ý	U+00FD	ý				
U+00DE		U+00FE	þ				
U+00DF	ß	U+00FF	ÿ				

The Western European basic and expansion character set shown above can be shown on the MFD.

As well as the Western European basic character set, you can also display characters (code page) of the Central European and Cyrillic code page (see online help for programming software).

11 Appendix

11.7 Central European expansion character set

You can use the Windows character table to enter characters that cannot be entered directly via the keyboard. Open the Windows XP character map via Start -> Programs -> Accessories -> System Tools -> Character Map or alternatively with Start -> Run -> Charmap.

11.7 Central European expansion character set

Unicode (hex)	Character	Unicode (hex)	Character	Unicode (hex)	Character	Unicode (hex)	Character
U+00C0	-	U+00E0	-	U+0100	-	U+0150	Ó
U+00C1	Á	U+00E1	á	U+0101	-	U+0151	ó
U+00C2	Â	U+00E2	â	U+0102	Ă	U+0154	Ř
U+00C3	-	U+00E3	-	U+0103	ă	U+0155	ř
U+00C4	Ä	U+00E4	ä	U+0104	Ț	U+0158	Ř
U+00C5	-	U+00E5	-	U+0105	ț	U+0159	ř
U+00C6	-	U+00E6	-	U+0106	Ć	U+015A	Ś
U+00C7	Ç	U+00E7	ç	U+0107	ć	U+015B	ś
U+00C8	-	U+00E8	-			U+015E	Ş
U+00C9	É	U+00E9	é	U+010C	Č	U+015F	š
U+00CA	-	U+00EA	-	U+010D	č		
U+00CB	Ë	U+00EB	ë	U+010E	Ď		
U+00CC	-	U+00EC	-	U+010F	đ	U+0160	Š
U+00CD	Í	U+00ED	í	U+0110	Đ	U+0161	š
U+00CE	Î	U+00EE	î	U+0111	đ	U+0162	Ţ
U+00CF	-	U+00EF	-			U+0163	ţ
U+00D0	-	U+00F0	-	U+0118	Ę	U+0164	Ť
U+00D1	-	U+00F1	-	U+0119	ę	U+0165	ť
U+00D2	-	U+00F2	-	U+011A	Ě	U+016E	Ů
U+00D3	Ó	U+00F3	ó	U+011B	ě	U+016F	ů
U+00D4	Ô	U+00F4	ô				
U+00D5	-	U+00F5	-	U+0139	Ł	U+0170	Ů
U+00D6	Ö	U+00F6	ö	U+013A	ł	U+0171	ů
U+00D7	-	U+00F7	-	U+013D	Ł	U+0179	Ž
U+00D8	-	U+00F8	-	U+013E	ł	U+017A	ž
U+00D9	-	U+00F9	-			U+017B	Ž
U+00DA	Ú	U+00FA	ú	U+0141	Ł	U+017C	ž
U+00DB	-	U+00FB	-	U+0142	ł	U+017D	Ž
U+00DC	Ü	U+00FC	ü	U+0143	Ň	U+017E	ž
U+00DD	Ý	U+00FD	ý	U+0144	ň		
U+00DE	-	U+00FE	-	U+0147	Ň	U+2013	–
U+00DF	ß	U+00FF	-	U+0148	ň		

11.8 Cyrillic expansion character set

Unicode (hex)	Character	Unicode (hex)	Character	Unicode (hex)	Character	Unicode (hex)	Character
U+00400		U+0420	Р	U+0440	р	U+0490	ѓ
U+0401	Ё	U+0421	С	U+0441	с	U+0491	ђ
U+0402	Ђ	U+0422	Т	U+0442	т		
U+0403	Ѓ	U+0423	У	U+0443	у	U+04BA	ћ
U+0404	Є	U+0424	Ф	U+0444	ф	U+04BB	ћ
U+0405	Ѕ	U+0425	Х	U+0445	х		
U+0406	І	U+0426	Ц	U+0446	ц		
U+0407	Ї	U+0427	Ч	U+0447	ч		
U+0408	Ј	U+0428	Ш	U+0448	ш		
U+0409	Љ	U+0429	Щ	U+0449	щ		
U+040A	Њ	U+042A	Ъ	U+044A	ъ		
U+040B	Ћ	U+042B	Ы	U+044B	ы		
U+040C	Ќ	U+042C	Ь	U+044C	ь		
		U+042D	Э	U+044D	э		
U+040E	Ў	U+042E	Ю	U+044E	ю		
U+040F	Ў	U+042F	Я	U+044F	я		
U+0410	CSA	U+0430	а				
U+0411	Б	U+0431	б	U+0451	ë		
U+0412	В	U+0432	в	U+0452	ђ		
U+0413	Г	U+0433	г	U+0453	ѓ		
U+0414	Д	U+0434	д	U+0454	є		
U+0415	Е	U+0435	е	U+0455	ѕ		
U+0416	Ж	U+0436	ж	U+0456	і		
U+0417	Э	U+0437	э	U+0457	ї		
U+0418	И	U+0438	и	U+0458	ј		
U+0419	Й	U+0439	й	U+0459	љ		
U+041A	К	U+043A	к	U+045A	њ		
U+041B	Л	U+043B	л	U+045B	ћ		
U+041C	М	U+043C	м	U+045C	ќ		
U+041D	Н	U+043D	н				
U+041E	О	U+043E	о	U+045E	ў		
U+041F	П	U+043F	п	U+045F	џ		

11 Appendix

11.8 Cyrillic expansion character set

Index

A

A, analog value comparator/threshold value switch (standard FB) 199
Adding
 Rung 102, 170
 Switch contact 102
Addressing examples 86
After abort PW entry 365
ALT pushbutton 146
Analog
 Operands 152
 Output QA1 114
 Output, Technical data 514
 Value output 403
Analog Input 507
Analogue
 Analog value comparator (standard FB) .. 199
Approval, Certification 493
AR, Arithmetic 204
Area of application 19
Arithmetic (standard FB) 204
Associated variable 377
Auxiliary relays -> Markers

B

Backlight, LCD display 456
Bargraph 396
Baud rate
 COM-LINK 134
 NET Station 440
BC, data block comparator (standard FB) 208
Bit display 388
Bitmap 391
Boolean operation (standard FB) 228
Break contact
 Inverting 168
BT, Data block Transformer (standard FB) 216
Bus connection plug 84
BUS DELAY 441
Bus termination resistor 83
BUSY 96
Button editor 417
Button elements 361, 417
Button field 386
BV, Boolean operation (standard FB) 228

C

C 232
Cable
 Cross-section 87
 Length 87
 Protection 57
 Resistance 87
Cable layout easyNet, network cable 83
Cancel, circuit diagram entry 170
Card -> Memory card
Central processing unit, Technical data, Real-time clock, Technical data 503
CF, Frequency counter (standard FB) 238
CH, High-speed counter (standard FB) 243
Change
 Password 448
Changing
 Coils and contacts 166
 Connections 169
 Contact, Switch duration and time 340
 Function block parameters 194
 NET configuration 129
 Value (operating method) 28
Changing input values, on function blocks ... 195
Changing NET ID and position 129
Character Set 373
Character set
 Central Europe 524
 Central European 523
 Cyrillic 523, 525
CI, High-speed incremental value counter (standard FB) 249
Circuit diagram
 Check 173
 Creating, example 98
 Creation, troubleshooting 488
 Delete 106, 107
 Display 99
 Elements 146
 Internal evaluation 469
 Saving 170
 Testing 104
Code page 523

Coil	
Connecting	169
Definition	147
Deleting	168
Entry, changing	167
Field	157
Function, overview	174
Negation	176
Searching	171
COM LINK	
Configure	133
COM-LINK	
Access method	187
active station	132
Baud rate	134
Connection	132
Data exchange	472
Monitoring connection	483
COM-LINK operands	184
Communication View	364
Comparator, CP (standard FB)	255
Compare	
Analog/threshold values	199
Marker ranges	208
Comparing	
Variables/constants	255
Compatibility for exchanging programs	159
Conditional jump, JC (standard FB)	291
Configuration, E/A device without own circuit diagram	443
Connect PC	89
Connecting	
20 mA sensor	71
Analog inputs	69
analog inputs	69
Analog output	80
Brightness sensor	71
Contactors, relays, motors	76
easyNet network	82
Expansion	54
Frequency encoder	67
High-speed counter	67
Inputs	60
Modem	90
Multi-function interface	88
Outputs	75
PC	89
Point-to-point communication	91
Power supply	57
Pushbuttons, switches	68
Pushbuttons, switches, contacts	62
Relay outputs	76
Setpoint potentiometer	71
Temperature inputs	72
Temperature sensor	71
Transistor outputs	78
Connecting a sensor (20 mA)	71
Connecting easyNet network	82
Connecting frequency encoders	67
Connecting incremental encoders	68
Connecting power supply	57
Connecting remote expansion	56
Connecting Servo valves	80
Connecting the brightness sensor	71
Connecting the modem	90
Connecting the serial interface	88
Connecting transistor outputs	78
Connecting.(ALT pushbutton)	146
Connection	
Deleting	169
Representation in circuit diagram display	157
Constants	
Alphabetical list	519
Assigning, FB input	193

Contact	157	Deleting	
Bounce suppression	474	Circuit diagram on card	164
Changing, N/O - N/C	168	Function blocks	196
Changing, Switch duration and time	340	Operands on FB inputs/outputs	194
Connecting	169	Retentive actual values	460
Cursor buttons	172	Retentive area	460
Definition		Rung	170
Deleting	168	Deleting retentive actual values	460
Entry, changing	166	Device	
Overview	148	Foot	53
Searching	171	Information	484
Contactor Function	174	Overview	21
Copy, marker ranges (CPY)	224	Device without display	452
Counter CH, up/down	243	Program transfer	159
Counter connection	67	Devices	
counter relays C (standard FB)	232	parameter EASY4...-DC-ME	119
Counter relays, C (standard FB)	232	Diagnostics	30
Counting		per Diagnostic bits	490
Incremental encoder	68	using the ID diagnostics contact	479
CP, comparator (standard FB)	255	Digital Inputs, Technical data	505, 506
Cursor buttons, function	145	Digital inputs/outputs EASY4..-DC-ME	121
Cursor display	36	Dimensions	495
Cycle pulse		Input/output modules MFD-R.., MFD-T...	497
Falling edge	176	MFD-80.. display/operating unit	495
Rising edge	176	MFD-80-XM protective diaphragm	497
Cycle Time	472	MFD-80-XS protective cover	498
Cyclical temperature measuring	113	Power supply unit/CPU MFD-CP8...	496
D		Dismantling	
Data block comparator, BC (standard FB)	208	Input/output module	49
Data block Transformer (standard FB)	216	Power supply unit/CPU	50
Data function block, DB (standard FB)	258	Display backlight	419
Data multiplexer, MX (standard FB)	303	Display messages	487
Data transfer speed	440	Display/Operating unit, technical data	501
Date and time inputs (screen editor)	412	Down counting, CH	243
Date indicator	30, 398	E	
Daylight Saving Time	465	EASY200-EASY coupling device	56
DB, data function block (standard FB)	258	EASY4..-DC-ME	
DC, PID controller (standard FB)	261	Digital inputs/outputs	121
DEBOUNCE	474	easyLink, Transfer behaviour	482
Deceleration time	475	easyNet connection cables	84
Delete		easyNet, Network	437
Password	449	Electrical isolation, between basic device and expansion unit	55
DELETE FUNCTION	446	Entry mode, visualization	417
Delete Program	130	Environmental Conditions	499
		Error -> Diagnostics	
		ESC button	145
		Evaluating falling edges	176
		Evaluating rising edges	176

Exchanging a Net station	491
Expansion units	
available	26
Connecting	54
EASY4...-DC-ME	117
monitoring	482
expansion units	481
Extended functionality of MFD-CP10... ..	27
External function keys	455

F

Factory Settings	463
Fault output	480
Fields	157
Frequency counter, CF (standard FB)	238
FT, Signal smoothing filter (standard FB)	268
Function block -> Function blocks	
Function block editor	192
Function block list	192
Function blocks	
Adding to the circuit diagram for the first time	189
Alphabetical list	516
Assigning operands	193, 194
Changing parameters	194
Checking	196
Coils, alphabetical list	517
Contacts, alphabetical list	518
Definition	146
Deleting	196
Editor for parameter setting	190, 192
General notes	188
Inputs, alphabetical list	
List	192
Memory requirement	520
Parameter dialog	190
Parameter setting	189
Function keys	
Visualization	416
Function overview	19

G

Get value	
from NET, GT (standard FB)	273
GO TO other rungs	171
Graphic elements	369
Ground	75
GT, get value from NET (standard FB)	273

H

High-speed counter, CH (standard FB)	243
High-speed incremental value counter CI (standard FB)	249
HW, weekly timer (standard FB)	276
HY, year time switch (standard FB)	282

I

I Pushbuttons	455
I/O module with temperature measuring	107
Impulse relay	175
Increasing	
input current	63
Input current	65, 66
Input delay	474
Inputs	
Connecting	60
Send change	442
Technical data	505
Installation	39
INTERFACE	446
INVALID PROG	163
Inverting	
Contact	168
Contactor function	176
IO-DEVICE	118

J

JC, conditional jump (standard FB)	291
Jump label, LB (standard FB)	294, 295
Jumping backwards	177
Jumps	177

K

Key to part numbers	24
Keypad	28

L

Lamp controller	100
Latching pushbuttons	385
Latching relay	175
LB, Jump label (standard FB)	295
LB, jump label (standard FB)	294
LE1	419

LED			
as Indicator lights	23		
Checking NET	489		
Display/keypad	23		
green	23		
Power supply unit/CPU module	23		
red	24		
Terminal Mode	23		
Limiting			
input current	64		
Loading visualization data	472		
Local expansion			
Connecting	55		
LS, Value scaling (standard FB)	295		
M			
Main menu			
Change to	32		
Overview	33		
Marker			
Assignment, EASY4..-DC-ME	120		
Read, example	187		
Write, example	187		
Marker ranges			
Copying	224		
Initializing	220		
Markers			
Assigning, FB input	193		
Definition	152		
Reset	300		
Retention	156		
Value range	156		
Master reset, MR (standard FB)	300		
Memory card	158		
EASY-M-256K	453		
EASY-M-512K	453		
Fitting	93		
Program transfer	158		
Memory display, circuit diagram	157		
Memory management			
Program memory	473		
Screen memory	473		
Memory requirement, for rungs and function blocks	520		
Memory, Technical data	503		
Menu language			
Initial switch on	95		
Menu structure	32		
Message			
Bitmap	395		
INVALID PROG	164, 488		
Operating system	487		
Text	375		
Message error rate	444		
Minimum clearances to the device	40		
Mode			
Entry	145		
Move	145		
Mounting			
Display/Operating unit	45		
Expansion units	54		
Inputs/outputs on the power supply/CPU module	48		
on mounting plate	53		
on top-hat rail	50		
Overview	41		
Power supply unit/central processing unit with display /operating unit	47		
protective cover	43		
Protective diaphragm	42		
MR, Master reset (standard FB)	300		
Multi-function interface			
monitoring	483		
MX, data multiplexer (standard FB)	303		
N			
N/C contact	147		
Overview	148		
N/O			
Overview	148		
N/O contact	147		
Inverting	168		
National approvals	493		
NC, Numerical converter (standard FB)	307		
Negate, coil	176		
NET			
Configure	127		
ID	179		
Operands	179		
PARAMETERS	129		
Replacing a NET station	491		
NET stations	437, 439		
NET-ID	440		
Network connection cable	84		
Network easyNet	437		
Network easyNet, Technical data	515		
Ni1000 Sensors	107		
Number formats	156		

Numerical converter, NC (standard FB)	307
Numerical setpoint value	406
Numerical value	400

O

OK button	145
Online Help	164
Operands	
Alphabetical list	519
Assigning	193
Assigning, FB output	194
Deleting on FB inputs/outputs	194
Operating buttons	
Function	145
Operating hours counter, OT (standard FB)	312
Operating mode	
CPY, copy marker ranges	224
Operating modes	96
Automatic change	443
Change	104
Change not detected (NET)	492
Operations	71
OT, Operating hours counter (standard FB)	312
Output formats	402
Outputs	
Connecting	75
Reset	300
Overload	79, 480

P

P Pushbuttons	
Status display	30
Parallel circuit, outputs	79
Parameter dialog, for function blocks	190
Parameter setting	
Function blocks	189
Parameters	
Enabling/disabling access	191
Passing through (network topology)	85
Password	
Activation	447
Changing	448
Deleting	449
Pause time	441
PID controller	
Output manipulated variable (PW)	319
PID controller, DC	
Special features	472
PID controller, DC (standard FB)	261
Point-to-point communication	91

Possible combinations, basic devices and expansion units	24
Power failure	96
Time switch	281
Power Flow Display	104
Power supply failure, station with NET-ID1	492
Power supply, Technical Data	502
Process image	469
Program	
Deleting on a memory card	164
Loading and saving with easySoft	164
Loading from the memory card	162
Saving on the memory card	162
Transfer from/to the memory card	158
Programming cable	89
Properties Field	363
Protecting areas	446
protective cover	43
Protective diaphragm	42
PT, Put value to network (standard FB)	315
PT100 Sensors	107
Pulse width modulation, PW (standard FB)	319
Pushbutton, for editing circuit diagrams and function blocks	145
Pushbutton, maintained	385
PW, Pulse width modulation (standard FB)	319
PW-1, PW-2, PW-3	365

R

R Pushbuttons	455
Reading, Sending the data via the NET	438
Reference potential	75
Register	
Associated variable/Name	386
Current screen	369
Display change	372
Languages	366
Operability	372
Passwords	366
Screen activation	367
Screens	365
Visibility	372
Relay	
Connecting outputs	76
Outputs, Technical data	510
Relays	
Coil function	174
Definition	147

Remote			
Marker (Merker)	133		
REMOTE IO	443		
REMOTE RUN	443		
Remote station			
Operand access	187		
Replace MFD-CP8...- with MFD-CP10...	362		
Reset, coil function	175		
Reset, Markers and outputs	300		
Response time			
Expansion unit	482		
NET Station	440		
Retention	458		
Setting	459		
Timing relay with retentive actual values	344		
Retentive markers	156		
Retrigger	346		
RJ45 socket, connection assignment	82		
Rolling text	384		
RUN	96		
RUN/STOP changeover	104		
Rung	157		
Adding new rung	102		
Adding/deleting	170		
Changing	171		
Deleting	171		
Running text	383		
S			
Safety rules, during installation	39		
Saving, circuit diagram	170		
Saving, Values	258		
SC, Set time/date (standard FB)	323		
Scaling range	407		
Screen			
Creating	371		
Elements	361		
Menu	382		
New create	365		
Screen elements	369		
Start screen	365		
Screw mounting	53		
Searching			
Contacts and coils	171		
Selection mode, visualization	416		
Self-latching, Circuit example	471		
SEND IO	442		
Send outputs	442		
Sending, Data via the NET	438		
Sensor types	107		
Servo valves			
Connecting	80		
Set cycle time, ST (standard FB)	337		
Set date	464		
Set Parameters			
Temperature module	108		
Set time	464		
Set, coil function	175		
Setpoint potentiometer, connecting	71		
Setting LCD contrast	456		
Setting the cycle time, ST (standard FB)	337		
Shift register, SR (standard FB)	325		
Shipping approvals	493		
Short-circuit	79, 480		
Sign of Life Signals	490		
Signal smoothing filter, FT			
Special features	472		
Signal smoothing filter, FT (standard FB)	268		
Simulation View	364		
Special Characters	373		
Spur line	85		
SR, Shift register (standard FB)	325		
ST, Set cycle time (standard FB)	337		
Standards	499		
Start behavior	97		
Starting	452		
Card	453		
RUN	452		
Terminal Mode	454		
Startup behavior	453, 454		
Default setting	454, 459		
Static text	373		
Station			
Addressing	86		
list create	126		
Stations			
Connecting (installation)	85		
number	440		
Status display			
Basic device	29		
Display	30		
Inputs	30		
Local expansion	31		
Other stations	131		
Outputs	30		
With star indication	137		
STOP	96		
Suppressor circuit	79		
Surge impedance	87		

Switch contact			
Contact name	166	
Contact number	166	
Entering	102	
Switch contact -> see Contact			
Switching contact			
Change between N/O - N/C contact	102	
Switch-on	95	
System information	30	
System menu			
Changing to	32	
Overview	34	
T			
T, timing relay (standard FB)	340	
Table function, TB (standard FB)	350	
Target group	19	
TB, Table function (standard FB)	350	
Technical data	507	
Temperature			
Inputs connecting	72	
measurement, EASY4..-DC-ME	120	
Measuring, connection	71	
Temperature module	107	
Analog value output	114	
Cycle time	117	
Diagnostics	116	
Hardware filter	109	
Resolution, temperature inputs	107	
Resolution, Analog output	115	
Scaling factor	112	
Scaling of temperature values	110	
Scan time	113	
SENSOR	110	
Software filter (PT1 filter)	113	
Value range for Visualization	112	
Value range for Visualization, Output	115	
Temperature range adjust	107	
Temperature sensor connection	71	
Terminal capacity	57	
TERMINAL MODE	96	
Automatic startup	454	
Terminal Mode	136, 439	
Terminal mode			
Close	141	
Terminations	57	
Testing, circuits via the P buttons	172	
Threshold value switch (standard FB)	199	
Time display	30	
Time indicator	398	
Time overlaps, Time switch	280	
Time switch			
24 hour switching	281	
Power failure	281	
Time/date setting, SC (standard FB)	323	
Timing relay and counter function block, example	358	
Timing relay value entry	411	
Timing relay, T (standard FB)	340	
Timing Relay, Technical data	503	
Toolbox	363	
Top-hat rail mounting	50	
Topology, easyNET	85	
T-piece and spur line (network topology)	85	
Transfer behavior, NET stations	438	
Transistor outputs, Technical data	512	
Transmission error	163	
Transmission security	444	
Troubleshooting			
During circuit diagram creation	488	
With result	489	
Two-wire proximity switches	63	
U			
Unconditional text display	384	
Unlocking, device	448	
Up counting CH	243	
User interface easySoft-Pro	363	
V			
Value			
Convert, BCD Binary	307	
Limitation, VC (standard FB)	355	
Put value to network, PT (standard FB)	315	
Saving	258	
Setting	37	
Value entry elements	406	
Value range	407	
Value range, markers	156	
Value scaling, LS (standard FB)	295	
VALUES			
Analog output	115	
Temperature input	111	
Variables			
Assigning, FB input	193	
VC, Value limitation (standard FB)	355	
Version number	485	
Visualization	361	
Voltage range, input signals	65, 66	

W

Weekday display	30
Weekday setting	464
Weekly timer inputs	413
Weekly timer, HW (standard FB)	276
Winter time	465
Wire breakage	
EASY4..-DC-ME	122
Temperature module	116
Wiring	
Arrow	102, 169
backwards	471
Grid	157
Workbench	363
Write repetition rate	441

Y

Year time switch	
Screen element	414
Year time switch, HY (standard FB)	282

Z

Zoom function, in the power flow display	105
--	-----