

# Control relay suitable for safety circuits easySafety ES4P



Powering Business Worldwide

All brand and product names are trademarks or registered trademarks of the owner concerned.

**Emergency On Call Service**

Please call your local representative:

<http://www.eaton.eu/aftersales>

or

Hotline of the After Sales Service:

+49 (0) 180 5 223822 (de, en)

[AfterSalesEGBonn@eaton.com](mailto:AfterSalesEGBonn@eaton.com)

**Original Operating Instructions**

The German-language edition of this document is the original operating manual.

**Translation of the original operating manual**

All editions of this document other than those in German language are translations of the original German manual.

1<sup>st</sup> published 2003, edition date 06/03

2<sup>nd</sup> edition 06/04

3<sup>rd</sup> edition 05/10

4<sup>th</sup> edition 06/11

5<sup>th</sup> edition 01/13

6<sup>th</sup> edition 02/16

See revision protocol in the “About this manual” chapter

© 2008 by Eaton Industries GmbH, 53105 Bonn

Production: Arno Dielmann, Benjamin Papst

Translation: globaldocs GmbH

All rights reserved, including those of the translation.

No part of this manual may be reproduced in any form (printed, photocopy, microfilm or any other process) or processed, duplicated or distributed by means of electronic systems without written permission of Eaton Industries GmbH, Bonn.



## **Danger!** **Dangerous electrical voltage!**

---

### **Before commencing the installation**

- Disconnect the power supply of the device.
- Ensure that devices cannot be accidentally restarted.
- Verify isolation from the supply.
- Earth and short circuit.
- Cover or enclose neighbouring units that are live.
- Follow the engineering instructions (AWA/IL) of the device concerned.
- Only suitably qualified personnel in accordance with EN 50110-1/-2 (VDE 0105 Part 100) may work on this device/system.
- Before installation and before touching the device ensure that you are free of electrostatic charge.
- The functional earth (FE) must be connected to the protective earth (PE) or to the potential equalisation. The system installer is responsible for implementing this connection.
- Connecting cables and signal lines should be installed so that inductive or capacitive interference does not impair the automation functions.
- Install automation devices and related operating elements in such a way that they are well protected against unintentional operation.
- Suitable safety hardware and software measures should be implemented for the I/O interface so that a line or wire breakage on the signal side does not result in undefined states in the automation devices.
- Ensure a reliable electrical isolation of the low voltage for the 24 volt supply. Only use power supply units complying with IEC 60364-4-41 (VDE 0100 Part 410) or HD 384.4.41 S2.
- Deviations of the mains voltage from the rated value must not exceed the tolerance limits given in the specifications, otherwise this may cause malfunction and dangerous operation.
- Emergency stop devices complying with IEC/EN 60204-1 must be effective in all operating modes of the automation devices. Unlatching the emergency-stop devices must not cause restart.
- Devices that are designed for mounting in housings or control cabinets must only be operated and controlled after they have been installed with the housing closed. Desktop or portable units must only be operated and controlled in enclosed housings.
- Measures should be taken to ensure the proper restart of programs interrupted after a voltage dip or failure. This should not cause dangerous operating states even for a short time. If necessary, emergency-stop devices should be implemented.
- Wherever faults in the automation system may cause damage to persons or property, external measures must be implemented to ensure a safe operating state in the event of a fault or malfunction (for example, by means of separate limit switches, mechanical interlocks etc.).



# Contents

<hr/>	
<b>About this manual</b>	9
List of revisions	10
Intended users	11
Exclusion of liability	13
Device designation	15
Reading conventions	16
<hr/>	
<b>1 easySafety</b>	17
Proper use	17
Overview of functions	18
Device overview	21
– easySafety-Basic device	21
– LED display	22
– Key to part numbers easySafety	23
easySafety operation	24
– Keyboard	24
– Selecting menus and entering values	24
– Status display for the easySafety basic unit	25
– Status display for the local expansion	27
– Status display additional information	29
– Menu structure	30
– Choosing the main and system menu	31
– Main menu	32
– System menu	33
– Selecting or toggling between menu items	37
– Cursor display	37
– Setting values	37
<hr/>	
<b>2 Installation</b>	39
Mounting	40
– Mounting on top-hat rail	41
– Screw mounting	42
Connecting the expansion device	43
Terminals	44
– Tools	44
– Cable cross-sections	44

Connecting the power supply	44
– Cable protection	44
– DC-Basic device	45
– DC expansion device EASY...-DC-.E	45
Connecting the inputs	46
– Connecting easy DC digital inputs	47
Connecting outputs	49
– Connecting the safety outputs (QS/QR)	49
– Connecting relay outputs	51
– Connecting transistor outputs	53
– Special requirement for ES4P-221-DMX.. devices with device version 02 or 10	55
– Connecting test signal outputs	57
Connecting network easyNet	59
– Connection assignment of the RJ45 socket on the device	59
– Prefabricated network connection cables	60
– User-assembled network connection cables	61
– Bus termination resistor	62
– Plugging and unplugging network cables	63
– easyNet-topologies	64
– Cable length with cross-sections	66
Connecting the serial multi-function interface	68
– Connection to a PC	69
– Connecting for point-to-point communication	70
– Inserting the memory card	72
Expanding inputs/outputs	73
– Local standard expansion device	74
– Remote standard expansion	75
<hr/>	
<b>3 Commissioning</b>	<b>77</b>
Switching on	77
Setting the menu language	78
easySafetyoperating modes	79
– RUN and STOP and BUSY	79
The first circuit diagram	81
– Starting point: the status display	83
– Switching to the standard circuit diagram	84
– Creating a standard circuit diagram for lamp controls	86

– Switching to the safety circuit diagram	92
– Creating a safety circuit diagram for an emergency-stop circuit	94
– Testing the safety circuit diagram	103
– Testing the standard circuit diagram	104
– Deleting the standard circuit diagram	107
– Deleting the safety circuit diagram	107
<hr/>	
<b>4 Wiring with easySafety</b>	<b>109</b>
easySafety operation	109
– Buttons for editing circuit diagrams and function blocks	109
– Operation	110
Circuit diagram elements	111
– Configuration	111
– Function blocks	113
– Relays	113
– Contacts	114
– Coils	114
– Markers	115
Circuit diagram display	120
Transfer from and to the memory card	122
– Information on the memory card	122
– Transfer from/to a device without display	123
– Loading and saving with a memory card	124
– Deleting a circuit diagram on the card	128
– Transferring the language from and to the memory card	128
Loading and saving with easySoft-Safety	129
Working with contacts and relays	131
– Entering and changing contacts and coils	132
– Creating or changing connections	137
– Adding or deleting rungs	139
– Saving circuit diagrams	139
– Aborting circuit diagram entry	140
– Searching for contacts and coils	140
– Got to a rung	141
– Deleting rungs	141
– Switching with the cursor buttons	142
– Checking the circuit diagram	143

- Coil functions 145
- Jumps 150
- Test outputs, test signals 153
- Working with function blocks 155
  - Adding function blocks to the circuit diagram for the first time 157
  - Setting function block parameters 158
  - Changing function block parameters 166
  - Deleting function blocks 170
  - Checking function blocks 171

---

**5 Standard function blocks 173**

- A, analog value comparator/threshold value switch 174
- AR, arithmetic function block 181
- BC, data block comparator 186
- BT, data block transfer 196
- BV, Boolean operation 210
- C, counter relay 215
- CP, comparator 223
- D, text display 226
- DB, data block 233
- DG, diagnostics 237
- GT, get value from the NET 242
- HW, seven-day time switch 246
- HY, year time switch 254
  - Function 254
  - Behaviour in the event of a power failure 255
  - Wiring of the function block 256
  - Parametric programming of the function block inputs/outputs 256
  - How the function block works 258
  - Entry rules 259
  - Sample parameter configurations 261
- JC, conditional jump 268
- LB, jump label 272
- MR, master reset 273
- MX, data multiplexer 276
- NC, numerical converter 282
- OT, operating hours counter 289
- PT - Put value to the NET 293



SC, set date/time	298
SR, shift register	300
T, timing relay	315
TB, table function	330
Example with timing relay and counter function block	337
<hr/>	
<b>6 Safety function blocks</b>	<b>341</b>
Rules in the safety circuit diagram	341
Common features	345
– Error contact ER	345
– Enable parameter, EN enable coil	345
– Operating mode parameter, RE reset coil	346
– Parameter SUT (Startup test)	347
– QV actual value output	348
– DG diagnostics output	348
– Application examples	348
EM, feedback circuit monitoring	349
EN, enable switch	360
ES, Emergency-stop	371
FS, safety foot switch	382
LC, light curtain	394
LM, light curtain muting	408
OM, Maximum speed monitoring	434
OS, operating mode selector switch	449
SE, Start element	458
SG, safety gate (optionally with guard locking)	465
TH, two-hand button	481
TS, Safety timing relay	494
ZM, zero (standstill) monitoring	509
<hr/>	
<b>7 easyNet network</b>	<b>521</b>
Introduction to the easyNet network	521
– Transfer behaviour of the NET stations	525
– Functions of the NET stations	526
– Function terminal mode	527
– Transfer of the standart- and safety circuit diagram via the NET	529
Commissioning NET stations	530

- "Commissioning NET stations" quick guide 532
- Parameterising and configuring NET stations 533
- Creating the station list 535
- Configure NET 536
- Changing the NET configuration 540
- Tip: Carry out a NET configuration through NET station 1 after every change to the NET. 541
- Checking the functionality of the NET 543
- Displaying the status display of other stations 546
- Wiring NET operands in the standard circuit diagram 547
- Description of the NET-PARAMETERS 559
- Replacing a NET station 565
- Power supply failure on station with NET-ID 1 566

---

**8 01/13 MN05013001Z-ENeasySafety Settings 567**

- Password protection 567
- General information 567
- Access levels 569
- Entering passwords 570
- Activating the password 574
- Unlocking easySafety 575
- Changing passwords 577
- Delete password 577
- Master password no longer known 578
- Sealing the safety configuration 580
- Enabling overwriting from the card 581
- Changing the menu language 583
- Setting date and time 584
- Changing between winter/summer time (DST) 585
- Setting DST parameters 586
- Activating/deactivating DEBOUNCE 589
- Activating DEBOUNCE 589
- Deactivating DEBOUNCE 590
- Activating and deactivating the P buttons 590
- Activating the P buttons 591
- Deactivating the P buttons 591
- Startup behaviour 592
- Setting the startup behaviour 592
- Behaviour when the circuit diagram is deleted 594

– Behaviour during upload/download to card or PC	594
– Possible faults	594
Setting contrast and backlight	595
Retention	597
– Requirements	597
– Setting retentive behaviour	598
– Deleting areas	599
– Deleting retentive actual values of markers and function blocks	600
– Retain retentive markers during transfer	600
– Transferring retentive behaviour	601
<hr/>	
<b>9 easySafety internal</b>	<b>603</b>
easySafety circuit diagram	603
– How the easySafety device evaluates the safety and standard circuit diagram as well as the function blocks	604
– What you must consider when creating the circuit diagram	606
Time behaviour of the inputs and outputs	608
– Input delay (debounce)	609
Reaction time of an easySafety device	612
Diagnostics	615
– Diagnostics using the ID diagnostics contact	615
– Diagnostics using the DG diagnostics function block	616
– Diagnostics-/Error codes	618
– Diagnostics using the ER contact	622
– Diagnostics of faults inside and outside the device	623
Expanding an easySafety device	627
– How is an expansion device detected?	628
– Transfer behaviour	628
– Monitoring the functionality of the expansion device	629
– Checking the transistor output for short-circuit/overload	630
Displaying device information	631
Device version	632

---

<b>Appendix</b>	633
List of function blocks	633
– Function block coils	635
– Function block contacts	637
– Function block inputs (constants, operands)	639
– Function block output (operands)	640
– Other operands	640
– Other function block parameters	641
Contacts and coils used in the circuit diagram	643
Memory requirement	657
Technical data	659
– General	659
– Voltage supply:DC	668
– Network easyNet	669
– Digital inputs 24 V DC	670
– Test signal outputs	671
– Relay outputs	672
– Transistor outputs	674
Dimensions	676

---

<b>Index</b>	677
--------------	-----

## About this manual

This manual describes the function scope, installation, commissioning and programming (circuit diagram creation) of the safety control relay easySafety.

Specialist electrical training is needed for commissioning and creating circuit diagrams. The user must also be aware of and adhere to all valid occupational safety and accident prevention guidelines, standards and regulations.

j

### **Danger!**

If active components are controlled, such as motors or pressurized cylinders, plant plants may become damaged or persons endangered, provided easySafety is incorrectly connected up, or incorrectly configured and programmed.

h

The term "EMERGENCY STOP" used in this manual corresponds to the "Stop in event of emergency" safety function in the easySafety safety control relay.

This safety function is identified as "EMERGENCY STOP" in the current version of the IEC 60204-1 (DIN EN 60204-1) standard.

The latest edition of this manual can be obtained from the Internet at:

[www.eaton.eu/doc](http://www.eaton.eu/doc)

Quick Search: MN05013001Z

More information about safety control relay:

[www.eaton.eu/easySafety](http://www.eaton.eu/easySafety)

**List of revisions**

The following significant changes have been made compared to the previous editions:

<b>Edition</b>	<b>Page</b>	<b>Keyword</b>	<b>New</b>	<b>Modification</b>
AWB2528-1599en (09/08)	53	Notes	✓	
	57	Hazard note		✓
	221	Signal diagram		✓
	323, 327	Signal Diagrams		✓
	346	Notes	✓	
	397, 413	Startup test, Parameter-Function		✓
	407	Signal Diagrams		✓
	417	Diagnostics-/-Error codes		✓
	441	Notes		✓
	501, 502, 503, 505	Signal Diagrams		✓
	506	Example, Emergency switching off: electrical circuit diagram 1) Use free-wheel diode suppressors for ES4P-221-DMX.. devices with device version 02 and 10		✓
	520	Legend for the graphic:		✓
	579	Notes		✓
	591	Notes		✓
	593	1st paragraph		✓
	595	2. x -Section		✓
	600	Deleting retentive actual values of markers and function blocks		✓
	625	Error class B (Error-Type)		✓
	633	Appendix		✓

<b>Edition</b>	<b>Page</b>	<b>Keyword</b>	<b>New</b>	<b>Modification</b>
MN05013001Z- EN (03/10)	18, 50	Furnaces		✓
	127	figure 48 + Legend	✓	
	344	Rule 30	✓	
	566	1st paragraph		✓
	613, 614	table 30 + Legend		✓
	626	Comments	✓	
	672	Safety level in accordance with EN 50156	✓	
MN05013001Z- DE (01/13)	53	chapter "Connecting transistor outputs"		✓
	55	chapter "Special requirement for ES4P-221-DMX.. devices with device version 02 or 10"	✓	
	153	figure 65		✓
	379	figure 188		✓
	405	figure 205		✓
	488	figure 251		✓
MN05013001Z- EN (02/16)	ff	Corrections and update Norm EN 954-1 deleted, transfer AWA and AWB to MN and IL		✓
	659	Technical Data, Standards		✓
	660	safety-relevant characteristic value		✓

---

**Intended users**

This manual is written particularly for planners, developers and operators of applications in electrical engineering, control system construction and machine building who wish to use the safety relays (easySafety devices) for the safe operation of a machine.



---

**Warning!**

Installation, electrotechnical expertise

A easySafety device must only be installed and connected up by trained electricians or other persons who are familiar with the installation of electrical equipment.

**j**

---

**Danger!**

It is assumed that operators have specialist electrical knowledge for configuration, creating circuit diagrams and start-up. Plant sections and persons are at risk if a easySafety device is incorrectly connected or configured and active components such as motors or pressure cylinders are controlled.



---

**Exclusion of liability**

We have provided all the information in this manual to the best of our knowledge and belief and in accordance with the latest state of the art. However, this does not exclude the possibility of inaccuracies so that we cannot accept any liability for the accuracy and completeness of the information. In particular, this information does not guarantee any particular properties.

The devices described must only be installed and operated in accordance with the content of documentation (this manual and the IL05013002Z installation instructions) provided with the device. Installation, commissioning, operation, maintenance and refitting of the devices must only be carried out by qualified persons. The devices must only be used in the areas recommended and only in conjunction with third-party devices and components that have been approved by us. Only use in technically faultless condition is permitted. Faultfree and safe operation of the system requires proper transport, storage, installation as well as careful operation and maintenance. If the following safety instructions are not observed, particularly with regard to commissioning and maintenance of the devices by insufficiently qualified personnel and/or in the event of improper use of the devices, any hazards caused by the devices cannot be excluded. We cannot accept any liability for any resulting injury or damage.

For example programming/configurations with easySafety the following also applies:

easySoft-Safety is a computer program for the generating and testing as well as the documentation and administration of configurations for easySafety devices. In order to demonstrate the generating of a configuration, Eaton provides prospective customers with sample programming and sample configurations for easySafety devices.

The use of such sample programs and of easySoft-Safety are subject to the following safety instructions and operating guidelines:

1. The configuration examples provided here have been created by Eaton to the best of its knowledge and belief and to the current technological standards. The possibility of errors in the configuration can not, however, be excluded and the provided configuration examples do not cover all function blocks and applications available for the easySafety devices. If you encounter any malfunction, error and/or any other problem when using the configuration samples, please contact your Eaton contact person.

2. The configuration, the preparation of a circuit diagram and the initial start-up of easySafety devices require safety know how and electro technical know how. If an easySafety-device is improperly connected or wrongly configured and active components such as motors and remote cylinders are being actuated, plant components and humans are endangered.

3. When using the provided sample programs and generating a configuration with easySoft-Safety, the user has the sole responsibility to observe the following:

- All relevant regulations regarding the preparation of a circuit diagram for easySafety-devices according to the updated user manuals AWA and AWB of ES4P by Eaton,
- All relevant regulations, directives, rules and standards of occupational safety and accident prevention regarding the intended preparation of circuit diagrams, initial start-up and the operation of easySafety-devices, particularly those issued by Employers' Liability Insurance Associations (Berufsgenossenschaft),
- Acknowledged rule of technology and state of science.
- All other general due diligence regarding the prevention of damages to life and physical condition of persons as well as material damage.

4. Eaton assumes no liability for any damage caused by the application of the provided sample programs contrary to the preceding safety instructions and operating guidelines according to the preceding numbers 1 to 3.

---

**Device designation**

The manual applies to the easySafety safety control relays which are part of the easy device family. The following terms are used for the device types if the description applies to all these types:

- easySafety for
  - ES4P-221-DMXX1
  - ES4P-221-DMXD1
  - ES4P-221-DRXX1
  - ES4P-221-DRXD1
  
- easy600 for
  - EASY618-.C-RE
  - EASY620-DC-TE
  
- easy800 for
  - EASY802-..
  - EASY806-..
  - EASY819-..,
  - EASY820-..,
  - EASY821-..,
  - EASY822-..

---

**Reading conventions**

Symbols used in this manual have the following meanings:  
x indicates actions to be taken.

**h****Caution!**

Warns of the risk of material damage.

**i****Warning!**

Warns of the possibility of serious damage and slight injury.

**j****Danger!**

Warns of the possibility of serious damage and slight injury or death.

**h**

Draws your attention to interesting tips and supplementary information.

For greater clarity, the name of the current chapter is shown in the header of the left-hand page and the name of the current section in the header of the right-hand page. This does not apply to pages at the start of a chapter and empty pages at the end of a chapter.

# 1 easySafety

## Proper use

The configurable safety control relay enables you to implement a large number safety-related tasks for system and machine building. The easySafety device is a safety element that monitors signal transmitters used as part of the guards on machines for the prevention of hazards to persons or equipment.

easySafety device is designed to be installed in an enclosure, switch cabinet or distribution board.

Power supply and signal terminals must be protected against accidental contact and covered.

The easySafety device may only be operated if it has been correctly fitted and connected by qualified electrical specialists. The installation must comply with regulations for electromagnetic compatibility (EMC).

**j**

### Danger!

The power up of the easySafety device must not cause any hazards arising from activated devices, such as unexpected motor startups or power ups.



### Warning!

Installation, electrotechnical expertise

## Overview of functions

The easySafety device is an electronic and configurable safety and control relay. Unlike conventional safety relays, these functions are not permanently set but can be configured as required. A safety control relay can therefore be used for a wide range of safety and standard functions in machine and plant construction.

### j

#### **Danger!**

The safety function is implemented by switching off the device outputs. In the safety state, the semiconductor outputs are 0 and the relay outputs are open. With a 2-channel architecture (category 3/4) use two device outputs or the redundant relay output for the disconnection.

The device is equipped with:

- Safety inputs and outputs.
- Test signal outputs.
- Safety function blocks.
- Logic functions.
- Time functions.
- Integrated display and operating elements.

A safety control relay enables you to implement a wide range of safety and control functions for plant and machine building applications. The wide variety of safety function blocks enables you to protect the hazardous area and prevent the occurrence any hazardous situations quickly and easily, depending on the safety category required. The configurable safety function blocks allow you to adapt your project to the safety category required.

The easySafety device may also be used for monitoring furnaces in accordance with EN 50156. For applications in continuous operation in accordance with safety level 3 of EN 50156 observe the note on Page 50.

The device uses its safety circuit diagram to monitor signal transmitters that are used as part of safety systems on machines for preventing hazards to persons or equipment,

provided that it is installed, connected and correctly configured correctly and in accordance with the relevant regulations.

The easySafety processes standard control tasks with its standard circuit diagram.

h

The data from the safety circuit diagram is also available for processing in the standard circuit diagram in order to ensure optimum utilisation of the device.

However, in order not to impair the safety-related functions, non-safety data from the standard circuit diagram is prevented from being used in the safety circuit diagram.

The integrated easyNet network makes it possible to connect up to eight Net stations to a PLC. All easySafety devices, devices of type easy800/MFD-Titan and PLCs of type XC200-/EC4-200 can be NET stations.

Each easyNet station can process its own safety circuit diagram and if required also a standard circuit diagram. This allows the design of systems using high-speed controllers with decentralised intelligence.

j

**Danger!**

easyNet is a network designed for non-safety applications. Data transferred via this network must **not** be used for safety-relevant applications.

The safety and standard circuit diagrams are created in ladder logic. The circuit diagram can be entered either on the device, using the operating buttons or on the PC using the configuration software easySoft-Safety.

For example, you can:

- Connect n/o and n/c contacts in series and in parallel
- Connect output relays and markers.

- Define outputs as coils, impulse relays, rising or falling edge-triggered relays or as latching relays.
- Configure ready-to-use and tested safety function blocks for your safety application.

The safety circuit diagram provides you with safety circuit diagrams such as emergency-stop functions, two-hand control buttons or safety timing relays. The function blocks in the standard circuit diagram provide you with several functions such as arithmetic functions, value comparison functions or up/down counting. All function blocks provided are listed in alphabetical order in the Appendix on Page 633. The cross-references provide links to detailed descriptions of these function blocks.

If you prefer to wire up the easySafety from a PC, then use the CL-SOFT configuration software.

A wide range of programming functions allow you, for example, to simulate the power flow in the safety and standard circuit diagram (offline test). You can also monitor the power flow and view the operand states (online test) after the safety and standard circuit diagram is transferred to the safety control relay.

You can protect your safety application as well as your know-how by entering a master, safety and/or standardpassword.

With the configuration software you can also print out your circuit diagram in different formats (e.g. DIN or ANSI or easy) and thus produce comprehensive documentation.



## Device overview

## easySafety-Basic device

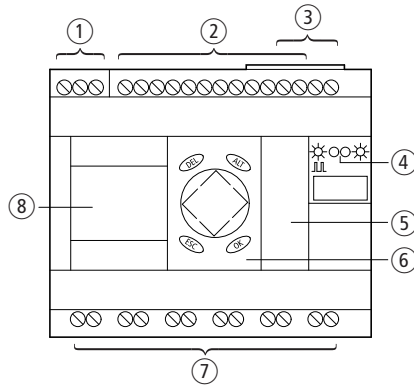

Figure 1: Versions

- ① Supply voltage, a page 44
- ② Inputs, a page 46
- ③ easyNet-Anschlüsse, a page 59
- ④ Power supply/mode and easyNet LEDs, a page 22.
- ⑤ Serial multi-function interface for memory card, PC connection or point-to-point connection, a page 68
- ⑥ Keypad, a page 24
- ⑦ Outputs and test signal outputs, a page 49
- ⑧ Display, a page 25

### LED display

easySafety is provided with two LEDs on the front (a figure 1 on Page 21):

- POW, RUN, FAULT.
- NET.

RUN, FAULT indicates the status of the power supply, RUN or STOP mode as well as any errors present.

Table 1: LED POW, RUN, FAULT

LED OFF	No power supply
LED continuously lit green	STOP mode, power supply present
LED flashes green (0.5 Hz)	RUN mode, power supply present.
LED continuously lit	STOP mode, class B fault detected, a page 624
LED flashing orange	RUN mode, class B fault detected, a page 624
LED continuously lit red	RUN/STOP mode, class A fault detected, a page 624

The NET LED provides information on the status of the easyNet (a section "Checking the functionality of the NET", Page 543).

Table 2: LED NET (easyNet)

LED off	easyNET not operational, fault, in configuration
LED continuously lit	easyNET is initialized and at least one station has not been detected.
LED flashing (0.5 Hz)	easyNET operating fault-free.

## Key to part numbers easySafety

ES4P- x x x - x x x x

Variant: 1 = 1. Variant

LCD display: X = No display, D = with display

Analog output: X = no analog output

Output type:

R = Relay outputs

M = redundant relay output and transistor outputs

Input type:

D = digital inputs

Number of bus systems:

0 = no bus system

1 = easyNet

Supply voltage: 2 = DC

Performance class 1, 2

(1 = without, 2 = with standard circuit diagram)

easySafety safety control relay:

E = easy, S = Safety, 4 = design (45 mm standard dimensions), P = module type (CPU),

easySafety operation

Keyboard

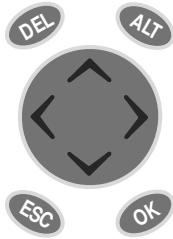

- DEL:** Delete object in circuit diagram
- ALT:** Special functions in circuit diagram, status display
- Cursor buttons** :
  - Move cursor
  - Select menu items
  - Change numbers, contacts and values
- OK:** Next menu level, Save your entry
- ESC:** Back, Cancel

Selecting menus and entering values



and

- Show System menu
- Move to next menu level Call menu item Activate, change, store entries
- Move to previous menu level
- Cancel entries since last **OK**



- Change menu item
- Change value
- Change place
- P button function:
 

Input P1	Input P2
Input P3	Input P4

### Status display for the easySafety basic unit

After power on, the easySafety device shows the status display of the basic unit. The status display has four lines. If you are operating a local expansion module via the easyLink connection, show the status display of the local expansion module on the display by pressing OK (a page 27).

Pressing ALT allows you to change the content of line 2 and 3 and the status display of the basic unit as well as the local expansion. Three different types of information can be shown.

h

When operating the easySafety device as a NET station you can press ESC to switch from the status display and select another NET station. You can then display the status of the inputs and outputs of the other NET station (a section "Displaying the status display of other stations", Page 546).

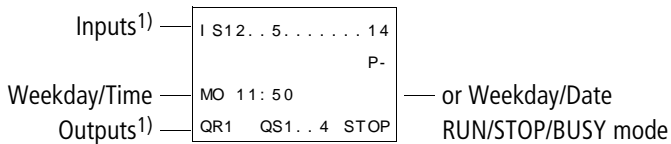

- 1) On: IS1, 2, 5, 14 and QR1, QS1, 4  
Off:...

Figure 2: Status display when you switch on

```

I S12. . . 5. 789. . . 14
                               P-
MO 11: 50
QR1  QS1. . . 4  STOP

```

**Lines 1 and 4: Inputs/outputs**

Line 1 shows the status of the basic unit inputs.

Line 4 shows the basic devices outputs and their operating mode (RUN, STOP or BUSY).

a section "easySafetyoperating modes", Page 79.

**Line 2: System information, diagnostics**

You can change the content of line 2 (and 3) by pressing ALT. After the initial power up, the easySafety device indicates with P- that the cursor buttons (P buttons) are not active and therefore cannot be used as button inputs in the standard circuit diagram. Active P buttons are indicated with P+ (a section "Activating and deactivating the P buttons", Page 590). The easySafety device will show further system information in line 2 (a section "Status display additional information", Page 29) depending on the parameters and the peripheral devices connected.

Starting from the initial status display, you can press ALT twice to show the following diagnostics messages in line 2 and 3:

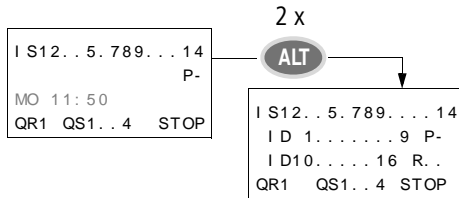

- Line 2: status of the local diagnostics bits ID1...ID9 and P-/+.
- Line 3: status of the local diagnostics bits I10...I16 as well as R15 and R16

**Line 3: Weekday, time/date, diagnostics**

In the initial status display, line 3 shows the weekday and the time.

Pressing ALT displays the weekday and date in line 3.

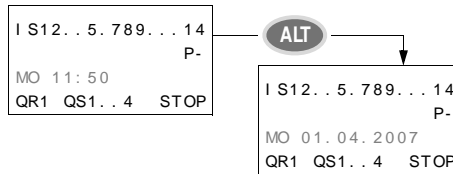
**Status display for the local expansion**

Press OK to move from the status display for the easySafety basic unit to the status display for the local expansion unit if the latter is being operated via the easyLink connection.

Pressing ALT allows you to switch the content of line 2 and 3 in the status display.

**j**

**Danger!**

easyLink is an interface designed for non-safety applications. Data transferred via this interface must **not** be used for safety-relevant applications.

**Lines 1 and 4: Inputs/outputs**

Line 1 shows the status of inputs R of the local expansion and line 4 that of outputs S. In addition line 4 indicates the basic devices operating mode.

```

R 12. . 5. 789. . 12
RS                               P-
MO 11: 50
S 12. . . . . 8   STOP

```

**h**

Apart from the ID RS in line 2, by which a connected functional expansion device is indicated, lines 2 and 3 indicate the same contents for basic unit and expansion device.

Press ALT once therefore to show in line 2 the weekday and the date, and press ALT twice to show also in line 2 and 3 the same diagnostics messages as in the status display for the basic unit.



### Status display additional information

Depending on the additional parameters set (e.g. retentive operands) or the connected peripheral devices (e.g. when running as an easyNet station) the system information listed below is also shown in the status display.

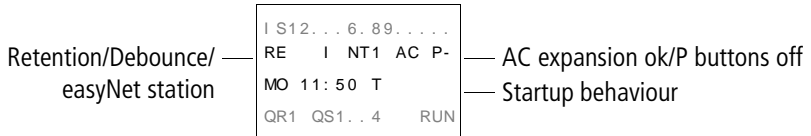

- RE : Retention switched on
- RS : Local expansion operating correctly
- I : Debounce switched on
- NT1 : easyNET station with Net-ID (1 in this case)
- AC : AC expansion functioning correctly
- DC : DC expansion functioning correctly
- GW : Bus coupling module detected  
GW flashes: Only easy200-easy detected. I/O expansion not detected.
- ST : When the power supply is switched on, the easySafety switches to STOP mode

## Menu structure

The easySafety device has two different menu structures, the main menu and the system menu.

The main menu provides the most frequently required functions during operation.

The system menu is used for entering global device parameters, and can be accessed without entering a password. The menus are marked by preceding letters to distinguish between safety and standard parameters:

- S stands for safety functions,
- STD stands for standard functions.

### Choosing the main and system menu

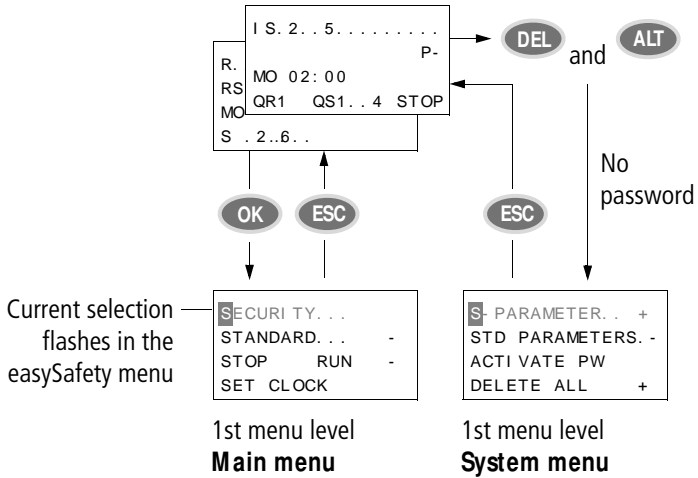

Figure 3: Entering the main or system menu

The possibly protected areas of the main and system menus are indicated by the characters behind the menu item:

- - protected by a standard password
- I protected by a safety password
- + protected by a master password (M PASSWORD)

h

Menu items that start with an inversely displayed letter (example: **S**ECURI TY... ) indicate safety-related functions.

### Main menu

x You access the main menu by pressing OK.

#### Main menu

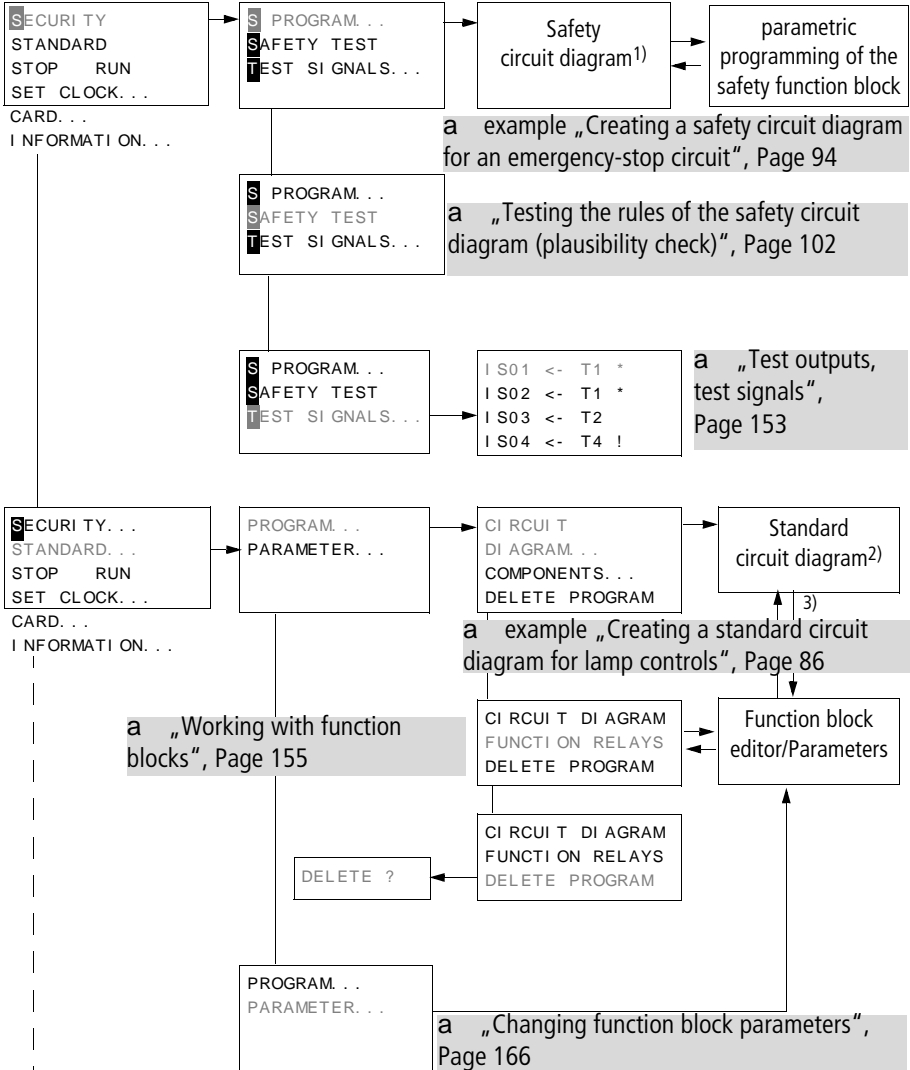

- 1) Change to the safety circuit diagram only with M password, a page 570
- 2) STOP: circuit diagram display, RUN: power flow display
- 3) Change only possible on initial call of the function block.

## 1 Main menu

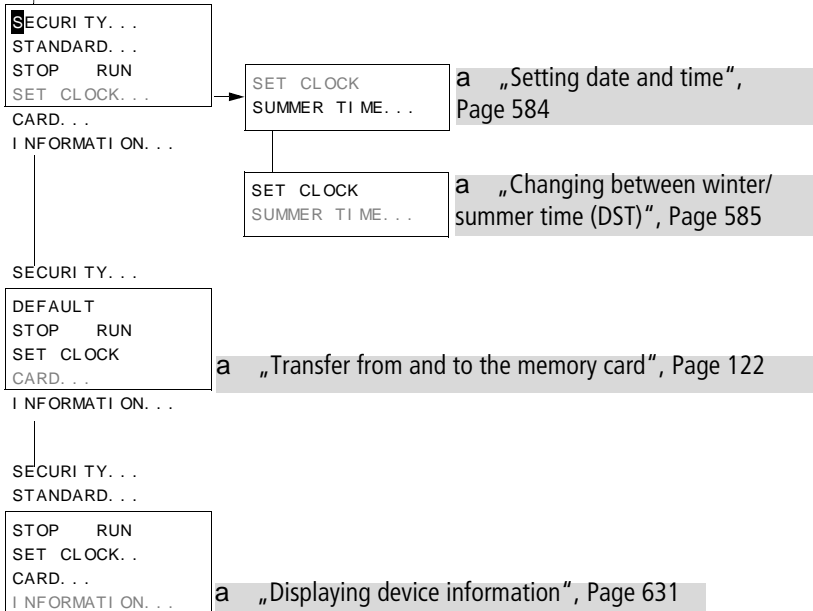

## System menu

x The System menu is accessed by simultaneously pressing DEL and ALT.

As in the main menu, this indicates protected areas by means of characters behind the menu item:

- - requires the standard password.
- I requires the safety password.
- + requires the master password.

To select protected menu items, enter the password after pressing OK.

System menu

S- PARAMETER...  
STD PARAMETERS  
ACTI VATE PW  
DELETE ALL

SAFETY- I D:

PROTECTI ON...  
SYSTEM...

M PASSWORD...  
S PASSWORD...

a „Password protection“, Page 567

M PASSWORD...  
S PASSWORD...

a „Sealing the safety configuration“, Page 580

PROTECTI ON...  
SYSTEM...

S SEAL- SAFETY  
TRNSF. FROM CARD

SEAL SAFETY I S  
NOT REVERSI BLE!  
OK- >ACTI VATE  
ESC- >CANCEL

S SEAL- SAFETY  
TRNSF. FROM CARD

a „Enabling  
overwriting from the  
card“, Page 581

1

1 System menu

S- PARAMETER...  
STD PARAMETERS  
ACTIVATE PW  
DELETE ALL

SAFETY-I.D: -

PROTECTI ON...  
SYSTEM...  
MENU LANGUAGE  
CONFI GURATOR...

STD PASSWORD...  
RANGE...

a „Password protection”, Page 567

STD PASSWORD...  
RANGE...

a „Protecting special standard areas”, Page 572

PROTECTI ON...  
SYSTEM...  
MENU LANGUAGE  
CONFI GURATOR...

P BUTTONS  
RUN MODE  
DEBOUNCE...  
DI SPLAY...

a „Activating/deactivating DEBOUNCE”, Page 589

RETENTI ON...  
P BUTTONS  
RUN MODE  
DEBOUNCE...  
DI SPLAY...

a „Setting contrast and backlight”, Page 595

RETENTI ON...  
P BUTTONS  
RUN MODE  
DEBOUNCE...  
DI SPLAY...  
RETENTI ON...

a „Setting retentive behaviour”, Page 598

PROTECTI ON...  
SYSTEM...  
MENU LANGUAGE  
CONFI GURATOR...

ENGLI SH  
DEUTSCH  
ITALI ANO

a „Changing the menu language”, Page 583

1

2

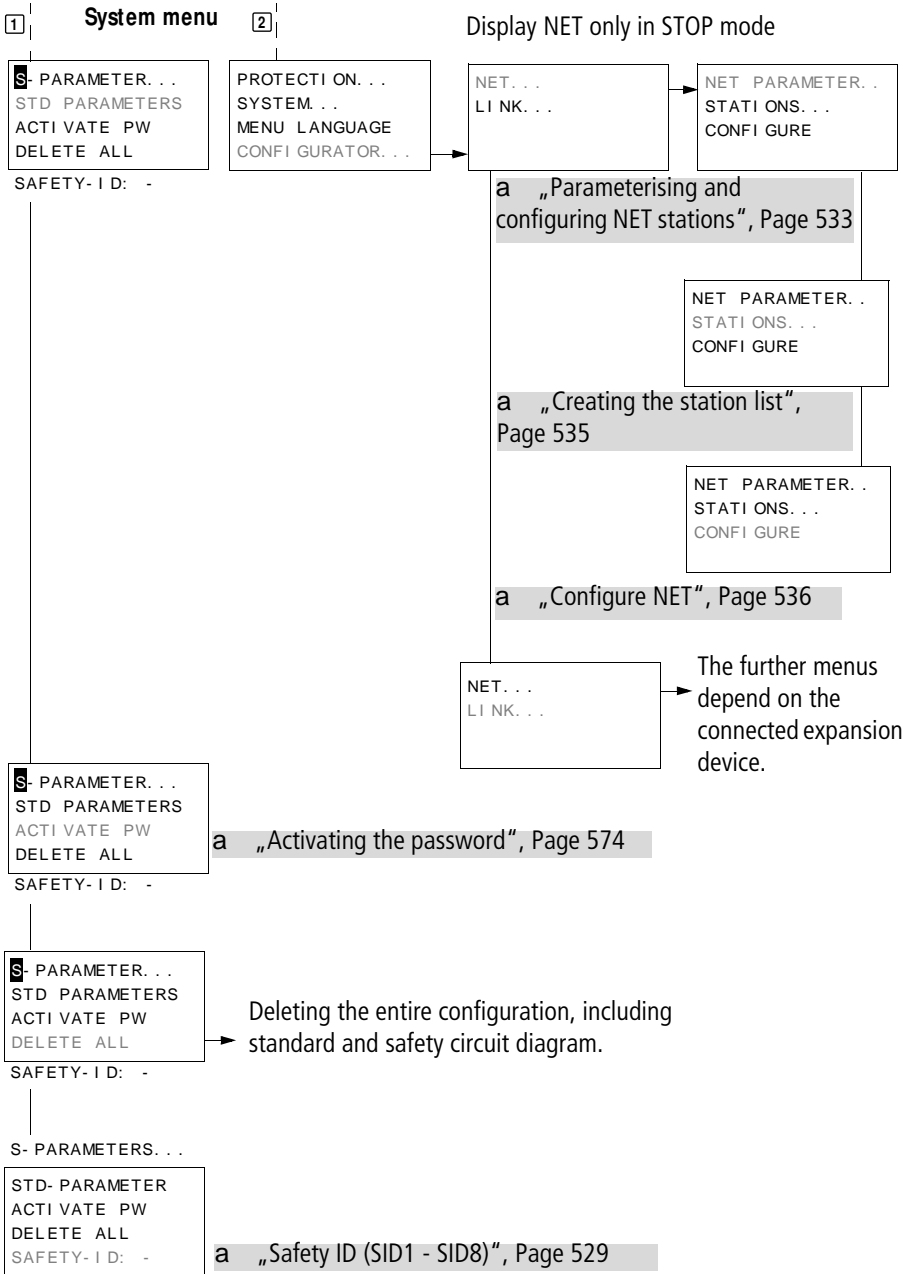



### Selecting or toggling between menu items



Cursor



Select or toggle

### Cursor display

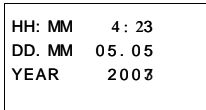

The cursor flashes.

Full cursor /:

- Move cursor with ,
- in circuit diagram also with

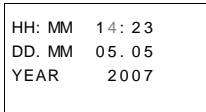

Value H/ H

- Change position with
- Change values with

Flashing values/menus are shown in grey in this manual.

### Setting values

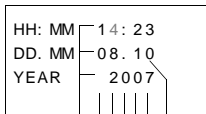

Values  
Places  
Value at place



Select value

Select digit

Change value at digit



Store settings



Retain previous value



## 2 Installation

easySafety devices must only be installed and wired up by qualified electricians or other persons familiar with the installation of electrical equipment.

j

### **Danger of electric shock!**

Never carry out electrical work on the device while the power supply is switched on.

Always follow the safety rules:

- Switch off and isolate.
- Verify isolation from the supply.
- Secure against reclosing.
- Short-circuit and ground.
- Cover adjacent live parts.

The devices are easySafety installed in the following order:

- Mounting
- Wiring up the inputs.
- Wiring up the outputs.
- Wiring easyNet network (optional).
- Connecting serial multi-function interface (optional).
- Connecting the power supply.

**Mounting**

Install a easySafety device in an enclosure, switch cabinet or distribution board so that the power feed and terminal connections cannot be touched accidentally during operation.

Snap the device onto an IEC EN 60715 top-hat rail or fix it vertically or horizontally in place using fixing brackets.

**h**

When using the easySafety device with expansion units, connect the expansion concerned before mounting (a page 43).

For ease of wiring of the device, leave a gap of at least 3 cm between the terminals and the wall or adjacent devices.

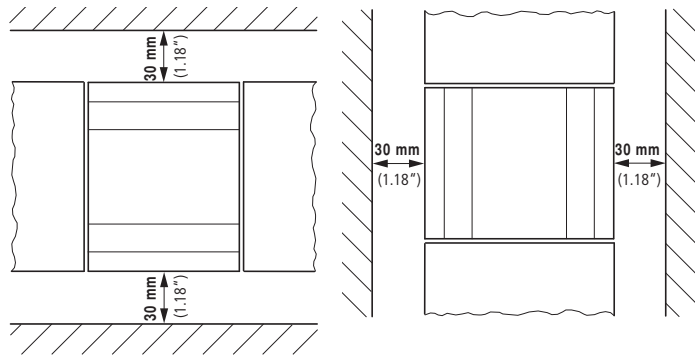
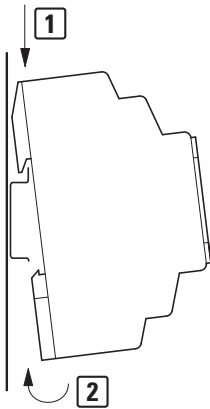

Figure 4: easySafety clearances to the device.



### Mounting on top-hat rail

x Place the easySafety device diagonally on the upper lip of the top-hat rail. Press down lightly on both the device and the top-hat rail until the unit snaps over the lower edge of the top-hat rail.

The easySafety device will clip into place automatically.

x Check that the device is seated firmly.

The device is mounted vertically on a top-hat rail in the same way.

### Screw mounting

Fixing brackets that can be inserted on the rear of the easySafety device are required for screw mounting. The fixing brackets are available as an accessory.

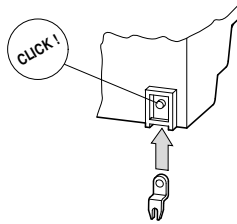

Figure 5: Inserting a fixing bracket

h

Three fixing brackets are sufficient for a device with four fixing points.

EASY2..-... easySafety, easy600

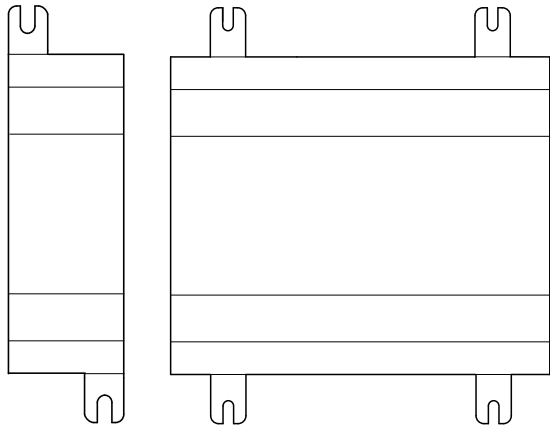

Figure 6: Screw mounting easySafety

---

**Connecting the expansion  
device**

Figure 7: Mounting 1 + 2 and removing 3 + 4 expansion modules.

---

**Terminals**

**Tools**

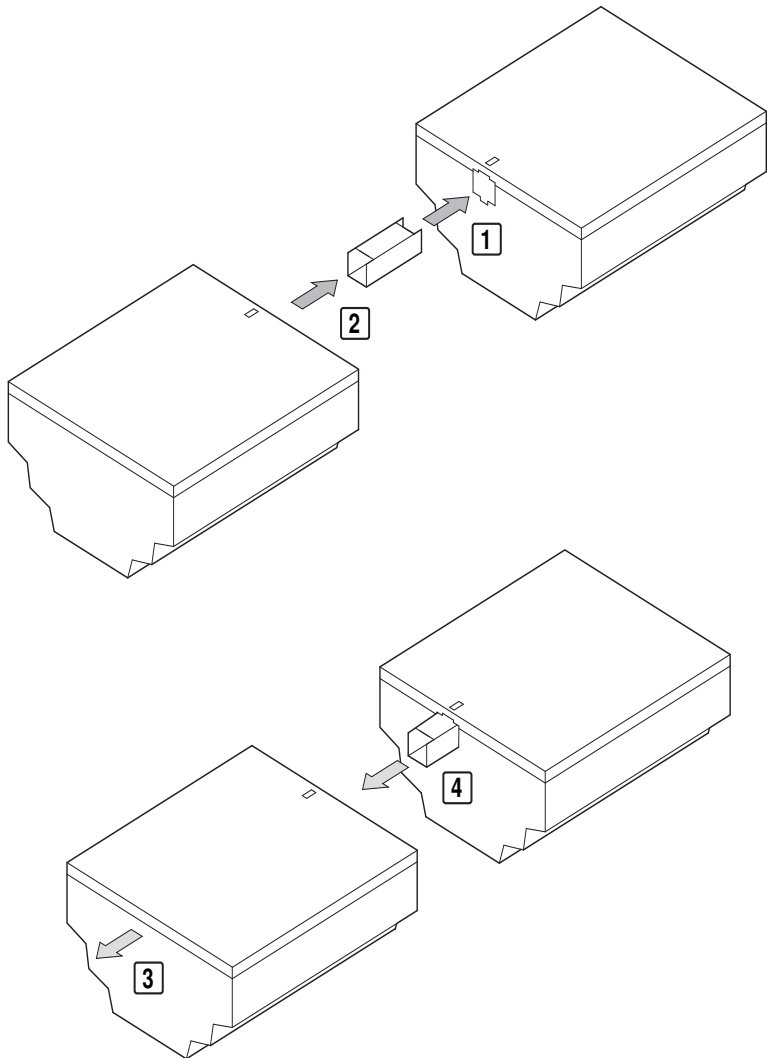
Slot-head screwdriver, width 3.5 mm, tightening torque 0.6 Nm.

**Cable cross-sections**

- Solid: 0.2 to 4 mm<sup>2</sup> (AWG 22 -12).
- Flexible with ferrule: 0.2 to 2.5 mm<sup>2</sup> (AWG 22 -12).

---

**Connecting the power supply**

**Cable protection**

Connect cable protection (F1) of at least 1 A (T) and no more than 4 A (T) to the easySafety device and to the standard expansion device.

**h**

**Caution!**

The first time it is switched on, the easySafety power supply behaves capacitively, and the inrush current that flows is higher than the nominal input current.

The switching device and the power supply device for switching on the power supply must be designed for this, i.e. no Reed relay contacts, no proximity switches.

When designing the DC power supply unit, bear the inrush current in mind and use time-lag fuses.

**h**

The connection data required for the device types is provided in chapter "Technical data", page 659.

The devices run a system test for three seconds after the power supply has been switched on. After this time the device switches to RUN or STOP mode depending on the default setting.



**DC-Basic device**

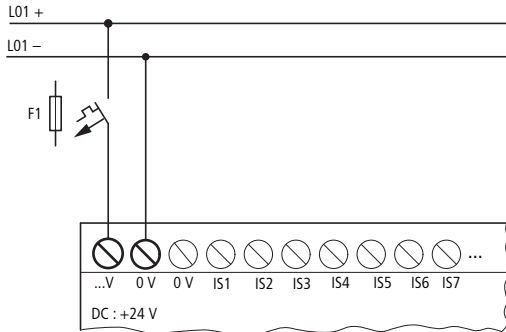

Figure 8: Power supply on the DC basic units

**DC expansion device EASY... -DC-E**

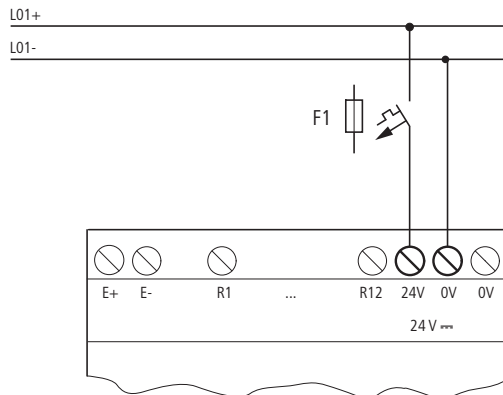

Figure 9: Supply voltage to DC expansion unit

**h**

The DC devices are protected against reverse polarity. However, ensure that the terminals are connected to the correct polarity so that the easySafety devices function properly.

### Connecting the inputs

The easySafety device is provided only with safety outputs. For safety applications, the IS safety inputs must be read in the safety circuit diagram, processed and output exclusively with the QR output (redundant relay output) or one of the QS outputs (safety transistor/relay outputs).

The inputs of the easySafety devices switch electronically. Once you have connected a contact via an input terminal, you can reuse it as a switching contact in the safety and standard circuit diagram as often as you like.

When using special function blocks, certain inputs are permanently assigned to these function blocks and cannot be used for any other purpose. The relevant function block description describes which inputs are affected.

Example: "Overspeed monitoring" safety function block, for which the device inputs IS1 and IS2 are connected directly.

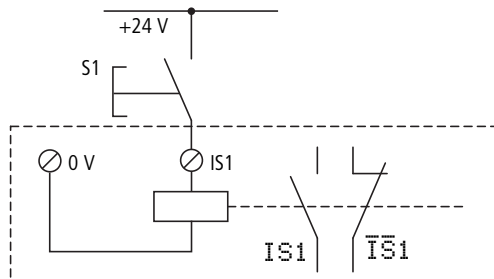

Figure 10: Connecting inputs, in this case IS 1.

Connect the contacts, for example buttons or switches, to the input terminals of the easySafety device.

### Connecting easy DC digital inputs

Use input terminals IS1 to IS14 to connect pushbutton actuators, switches or 3 or 4-wire proximity switches. Given the high residual current, do not use 2-wire proximity switches. Monitored inputs on the basic unit are fed by test signal outputs T1 to T4.

Input signal voltage range

- IS1 to IS14 and R1 to R12.
  - Off signal: -3 to 5 V.
  - On signal: 15 to 28.8 V

Input current:

- IS1 to IS14: 5.7 mA at 24 V
- R1 to R12: 3.3 mA at 24 V

**h**

Feed the digital inputs from the same 24 V DC power source as the device.

If the feed cables have to be monitored, use the test signal outputs as shown in the following figure 11. See also section "Connecting test signal outputs" on page 57.

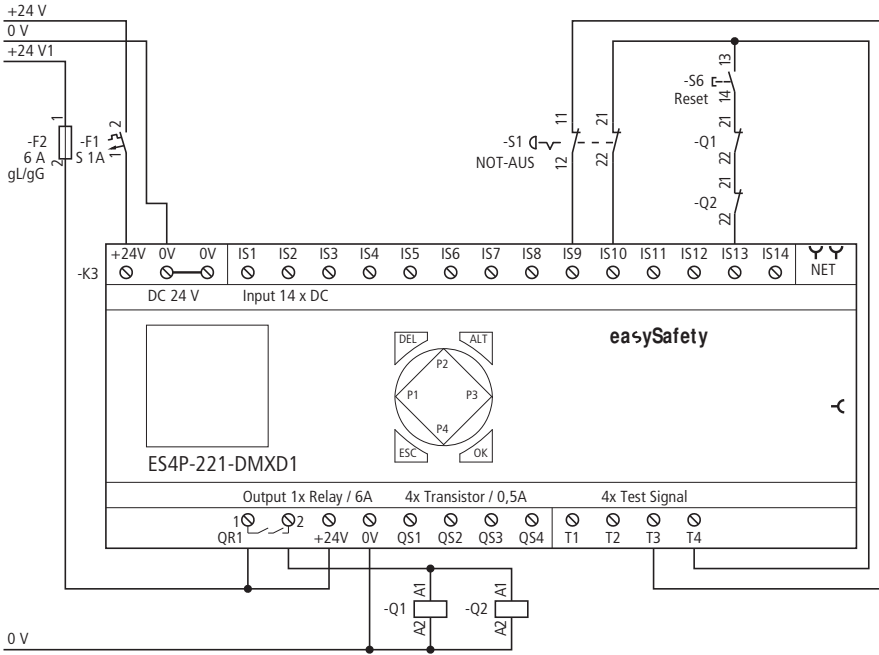

Figure 11: Example application with basic device easySafety

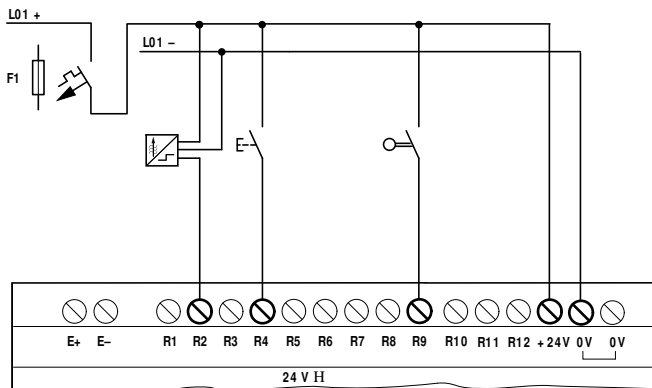

Figure 12: EASY6...-DC-E (standard expansion device)

**Connecting outputs**

The easySafety device has safety outputs (QR/QS) and test outputs with test signals (T1-T4) exclusively. Test signals are used to detect cross circuits (a section "Test outputs, test signals" on page 153).

**h**

Connect the test signal outputs T1 to T4 with the inputs in order to be able to detect peripheral faults such as cross-circuits between the signal cables. They are not intended for operating loads.

**Connecting the safety outputs (QS/QR)**

A value that is read at the safety input and processed in the safety circuit diagram can be output safely via the output QR (redundant relay output) or one of the outputs QS (safety transistor/relay outputs).

The safety outputs (QR/QS) can also be used in the standard circuit diagram providing the following is observed.

**h**

A safety output (QR/QS) can either be used in the safety circuit diagram or as a non-safety output in the standard circuit diagram. A double use of this output type causes an error signal with the circuit diagram safety test as it would contravene rule number 9 (a section "Testing the rules of the safety circuit diagram (plausibility check)" on page 102).

**j****Danger!**

Device outputs QR and QS that are set by the standard circuit diagram are not safety outputs and must only be used for standard tasks. Make sure that these outputs do not trigger any safety-related actions on the machine or plant.

The QS./QR. outputs function inside as isolated contacts.

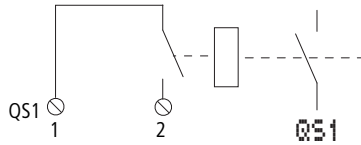

Figure 13: Connecting outputs, in this case QS 1

The corresponding relay coils are triggered in the standard circuit diagram or safety circuit diagram via outputs QS1 - QS4 and QR1. You can use the signal states of the output relays in the standard circuit diagram or safety circuit diagram as N/O contacts for further switch conditions.

The relay or transistor outputs are used to switch loads such as Connecting: Contactors, relays or motors. Prior to installation observe the technical limit values and data for the outputs (a section "Technical data", page 659).

# h

**Caution!**

easySafety may be used in applications up to safety level 3 in continuous operation in accordance with EN 50156 if:

- the time between the functional checks on easySafety do not exceed six months.
- redundant relay contacts are used for the safety disconnection of the fuel supply on furnaces. This can be achieved by:
  - series connection of two QS outputs (ES4P-221-DR...), a figure 15 on page 51.
  - use of the internal redundant relay output QR1 (ES4P-221-DM...), a figure 14 on page 51.

Connecting relay outputs

h

**Caution!**

Test the relay outputs at least once in 6 months.

**ES4P-221-DM..**

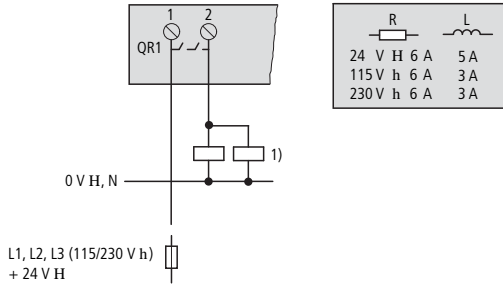

Figure 14: ES4P-221-DM... redundant relay output

1) Architecture of categories 3 and 4 in accordance with EN ISO 13849-1 if both contactors and ES4P... are located in the same control cabinet.

j

**Danger!**

Do not exceed the maximum voltage of 250 V AC on a relay contact. If the voltage exceeds this threshold, flashover may occur at the contact, resulting in damage to the device or a connected load.

**ES4P-221-DR..**

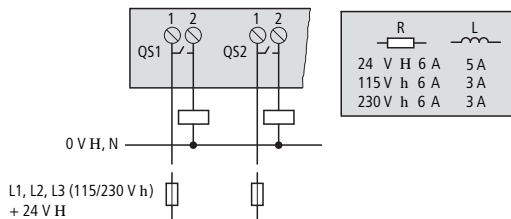

Figure 15: Relay outputs ES4P-221-DR...

**EASY6...-RE.. (standard expansion device)**

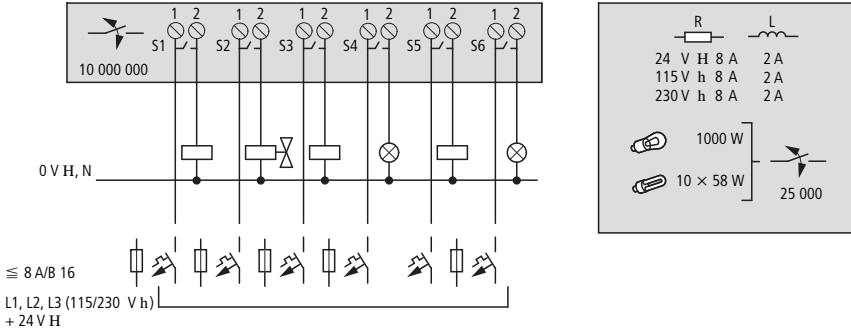

Figure 16: EASY6...-RE..relay outputs

**EASY2...-RE (standard expansion device)**

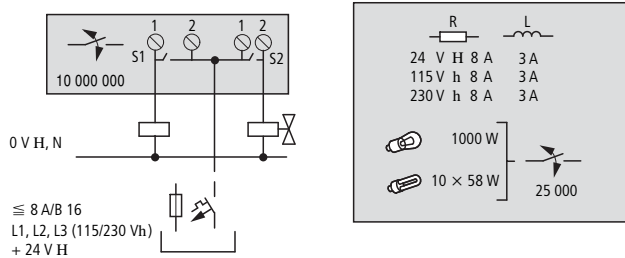

Figure 17: EASY2...-RE..relay outputs



## Connecting transistor outputs

**i**

For ES4P-221-DMX.. devices with device version 02 or 10, make sure to connect inductive loads (such as contactors and valves) with free-wheel diode suppressors. Otherwise, the output driver may fail. The device will detect the fault and will shut down safely, but will be permanently damaged.

For ES4P-221-DMX.. devices with device version 20 or higher, it is not necessary to use free-wheel diode suppressors.

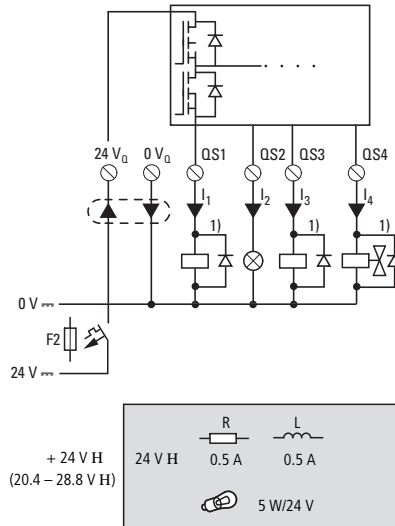

Figure 18: Transistor outputs ES4P-22.-DM..  
 1) Use free-wheel diode suppressors for ES4P-221-DMX.. devices with device version 02 and 10

**i**

### Danger!

The parallel connection of the safety transistor outputs QS1 to QS4 of a easySafety basic unit is not permissible and causes a fault message (fault category B, a page 622). The outputs are switched off as result.

- h** Power the transistor outputs with voltage!  
If the transistor outputs are not supplied, the easySafety will generate a category B fault, a page 622. This causes all outputs to be switched off.
- h** Take into account the time behaviour of the transistor outputs when choosing the actuator that the easySafety device will be actuating. (a „Time behaviour of the inputs and outputs“, page 608).

**EASY6..-DC-TE (standard expansion device)**

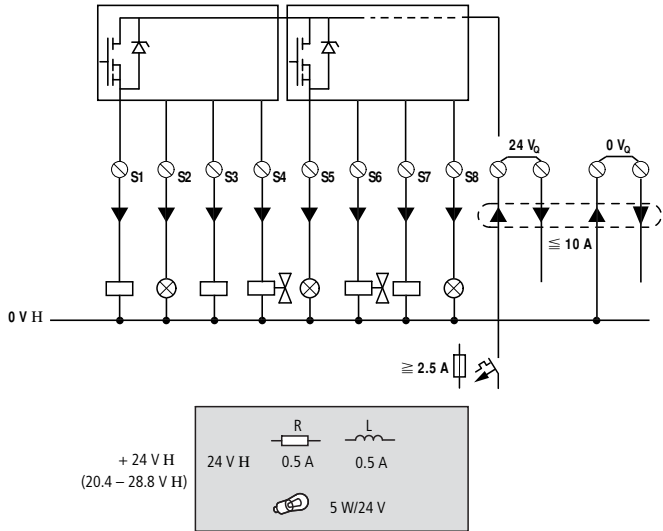

Figure 19: EASY6..-DC-TE transistor outputs

**Parallel connection:**

Up to four outputs can be connected in parallel in order to increase the power. This enables a maximum output current of 2 A.

**Danger!**

Danger! Only outputs of the same group (S1 to S4 or S5 to S8) can be connected in parallel; e.g. S1 and S3 or S5, S7 and S8. Outputs connected in parallel must be switched at the same time.

**Behaviour in the event of a short-circuit/overload**

In the event of a short-circuit or overload on a transistor output of a easySafety basic device, all outputs are disconnected. Once you have rectified the fault or malfunction, you can reset the easySafety device by switching the power supply off and on again.

If the short circuit or overload occurs on a non-safety expansion device, only this output switches off. The output will switch back on up to the maximum temperature after a cooling time that depends on the ambient temperature and the current level. If the fault condition persists, the output will keep switching off and on until the fault is corrected or until the power supply is switched off (a section "Diagnostics", page 615).

**Special requirement for ES4P-221-DMX.. devices with device version 02 or 10**

It is necessary to ensure that, in the event of a short-circuit, the power supply unit being used will provide sufficient current to reliably trip the selected F2 cable protection. This is only required for applications that use two-channel safety modules (redundant outputs).

In order to take appropriate precautions for a short-circuit, follow the steps below:

- x Select the right F2 cable protection.
- x Use a power supply unit with enough output current .

**Selecting the F2 cable protection**

The cable protection chosen should have a maximum rated operational current  $I_n$  of 3.15 A. Since the maximum permissible load current is 2.4 A (with 4 connected transistor outputs at 0.5 A each and a tolerance of 20%), F2 will be properly dimensioned with 3.15 A.

The cable protection chosen must have a rated operational current  $I_n$  with at least the following value; see a figure 18, page 53:

$$I_n > I_L = I_1 + I_2 + I_3 + I_4 ; \text{ with } I_L \text{ at } U_{emax}$$

Use an F2 cable protection of table 3 or types with the same characteristic.

**Selecting the power supply unit**

The overload trip conditions (in the table below) that apply will depend on the selected F2 cable protection. Make sure to use power supply units with an appropriate output current accordingly.

Table 3: Overload trip conditions for F2 in applications with two-channel safety modules

F2	Trip condition
FAZ-B( $I_n$ )/1; $I_L < I_n$ F 3A	7 x $I_n$ , 30 ms
FAZ-Z( $I_n$ )/1; $I_L < I_n$ F 3A	4.2 x $I_n$ , 30 ms
FF( $I_n$ ); $I_L < I_n$ F 3.15 A	4 x $I_n$ , 50 ms

Example:

Transistor outputs QS1, QS2, and QS3 each switch a contactor with a rated pick-up current of 400 mA. The maximum permissible rated operational voltage range limit is:

$$U_{\text{emax}} = U_e + 20\% = 28.8 \text{ V}$$

The maximum pick-up current with  $U_{\text{emax}}$  is:

$$I_{\text{Lmax}} = 1.2 (3 \cdot 0.4 \text{ A}) = 1.44 \text{ A}$$

Using the conditions in table 3 yields the following cable protection and power supply unit choices:

F2	Power supply unit output current
FAZ-B(1.6)/1	( 7 x 1.6A ) 11.2A for 30 ms
FAZ-Z(1.6)/1	( 4.2 x 1.6A ) 6.72A for 30 ms
FF(2);	( 4 x 2A ) 8A for 50 ms

### Connecting test signal outputs

The easySafety devices are provided with 4 test signal outputs (T1 to T4). These outputs (T1 to T4) generate periodic test signals that are looped back to an IS... input and evaluated inside the device. In this way, it is possible to detect external faults (e.g. cross-circuits).

**i**

#### **Danger!**

Use the test signal outputs exclusively for activating the inputs. The activation of loads is not permissible.

A test signal T... can be applied to several IS... inputs if cross-circuits between the supply cables used can be excluded.

**j**

#### **Danger!**

Make sure that the test signals are correctly assigned and that there are no missing signal assignments for the device's IS safety inputs. Ensure that the multiple use of test signal outputs does not cause hazardous faults, for example, because a cross-circuit cannot be detected. Check the error detection mechanism extensively during commissioning.

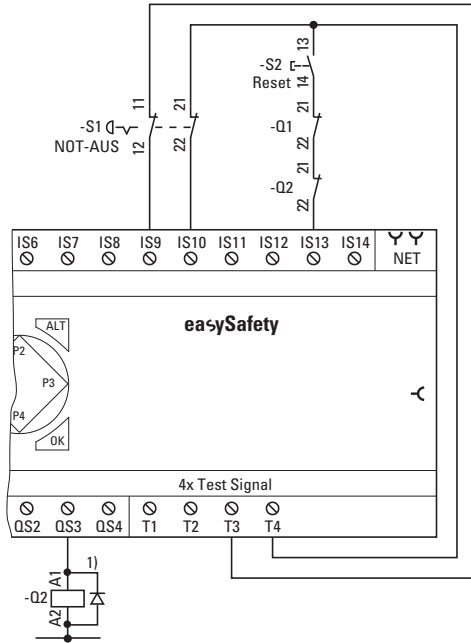

Figure 20: Sample application of test signal outputs in a dual-channel emergency stop circuit  
1) Use free-wheel diode suppressors for ES4P-221-DMX.. devices with device version 02 and 10

## Connecting network easyNet

easyNet is a network for non-safety applications to which a maximum of 8 nodes can be connected. Any device with a network connection can be an easyNet node. Further information on configuring and commissioning the easyNet is provided in chapter "easyNet network", page 521. Specifications for the easyNet are provided in the Technical Data, page 669.

# j

### Danger!

Safety-related data must not be transferred on the easyNET.

### Connection assignment of the RJ45 socket on the device

The networkable devices are provided with two RJ45 sockets.

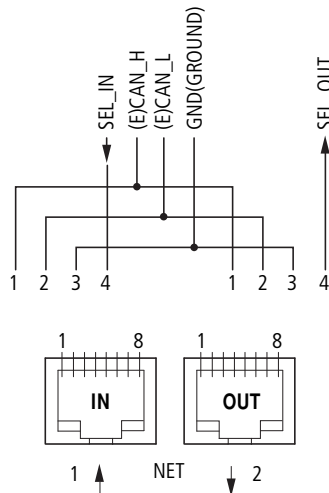

Figure 21: RJ45 socket

Socket 1 (IN) is used for connecting the incoming cable from the physically preceding easyNet station. Socket 2 (OUT) is used for connecting the outgoing cable to the physically next easyNet station.

The physically first and last stations in the easyNet network must each be terminated with a bus termination resistor. Because the physically first easyNet station has no predecessor, the bus termination resistor is connected to socket 1 here. Accordingly, the bus termination resistor is connected to socket 2 of the last easyNet station.

**Prefabricated network connection cables**

The following network connection cables are available for simple installation:

Table 4: Prefabricated cables, RJ45 plug on both ends

<b>Cable length cm</b>	<b>Type designation</b>
30	EASY-NT-30
80	EASY-NT-80
150	EASY-NT-150



### User-assembled network connection cables

The following components are available for assembling different cable lengths:

- Supply cable
  - Type - EASY-NT-CAB, cable 100 m, 4 x 0.18 mm<sup>2</sup>.
- Bus connection plug
  - RJ45 plug, type: EASY-NT-RJ45 (8-pole)
- Tools
  - Crimping tool for RJ45 plug, Type: EASY-RJ45-TOOL.  
AWG 24, 0.2 mm<sup>2</sup> is the largest crimpable cross section.

h

The table on page 66 provides information for the required cable cross-section of longer cable lengths, taking the cable resistance into account.

### Cable layout

4-core, twisted pair; a section "Technical data", page 659.

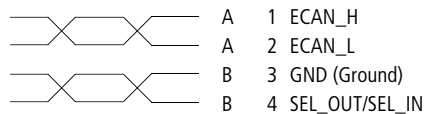

Figure 22: Connection assignment

- ECAN\_H data cable, pin 1, cable pair A.
- ECAN\_L data cable, pin 2, cable pair A.
- Ground cable GND, pin 3, cable pair B.
- Select cable SEL\_IN, pin 4, cable pair B.

h

The most basic easyNet configuration operates with the cables ECAN\_H, ECAN\_L, GND. The SEL\_IN cable is only used for automatic addressing and configuration.

### Bus termination resistor

The physically first and last stations in the easyNET network must each be terminated with a bus termination resistor.

- Value: 124 Ω.
- Connection plug : EASY-NT-R.

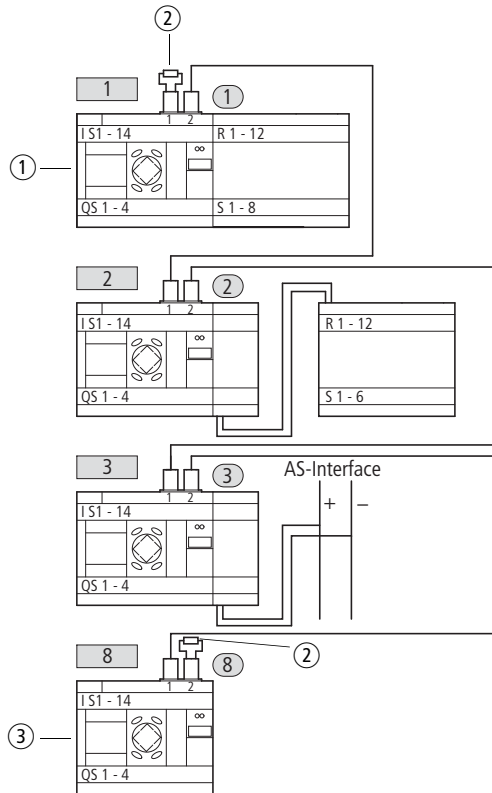

Figure 23: Bus terminating resistors

- ① First station on the easyNet
- ② Bus termination resistor
- ③ Last station on the EasyNET network
- Physical location, place
- Station number

## Plugging and unplugging network cables

Both RJ45 interfaces are visible after the cover plate has been removed.

When a cable is plugged in, the mechanical connection must be audible (click) and visible **1**.

Before a plug or cable is removed, the mechanical locking feature must be undone **2**, **3**.

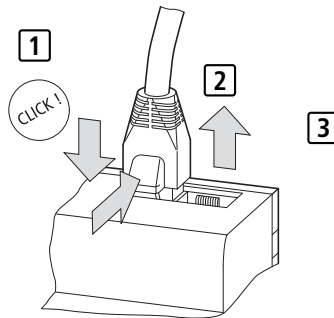

Figure 24: Plugging and unplugging cables

## Connecting easyNet stations

Proceed as follows in order to connect the easyNet stations:

- Plug in the network connection cable into the easyNet socket 2 of the first physical easyNet station.
- Plug in the network connection cable into the easyNet socket 1 of the last physical easyNet station.
- Fit the bus terminating resistor in socket 1 of the first station and in socket 2 of the last station.
- Connect all stations to the power supply.

### easyNet-topologies

easyNet allows you to configure line topologies in which all stations are connected to a main cable. Two types of cable routing are possible:

- Loop-through cable routing.
- Wiring arrangement using a T connector and a spur line.

#### Passing through

Advantage: With this wiring arrangement, the cable is looped through the device. The easyNet stations can be addressed and easyNet configured very simply via station 1 (a section "Parameterising and configuring NET stations" on page 533) or via easySoft-Safety.

Disadvantage: If the line is interrupted, the easyNET network is no longer operational from this point in the network.

#### T connector and spur line.

Advantage: If an easyNet station fails, the spur line can be removed from the station for the exchange, whilst all other devices on the easyNet remain functional.







Disadvantage: Each device must be addressed individually with this wiring method:

- By downloading the program of the easySafety configuration including the NET-ID via easySoft-Safety (see Help). For this the programming cable must be plugged in locally on each individual device.
- Via the operator buttons and display of the individual device (a section "Parameterising and configuring NET stations" on page 533).

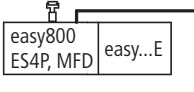
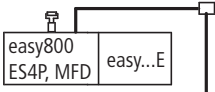
h

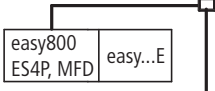
The spur line between the T connector and the device must not exceed 0.3 m. Otherwise communication via easyNET may be impaired.

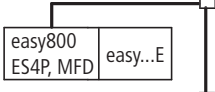
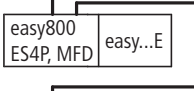
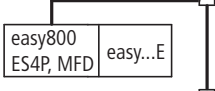
## Addressing examples

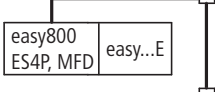
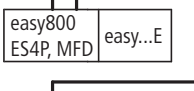
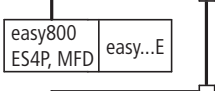
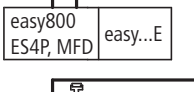
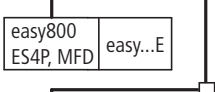
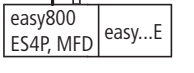
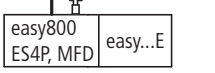
Physical location, place	Station number		"Loop through the unit"	T connector and spur line
	Example 1	Example 2		
1	1	1		
2	2	3		
3	3	4		
4	4	8		
5	5	7		
6	6	2		
7	7	6		
8	8	5		

- Example 1: Physical location is the same as the station number
- Example 2: Physical location is not the same as the station number (apart from location 1 being the same as station 1).

h

Physical location 1 is always assigned as station 1. Station 1 is the only station which must be present.

**Cable length with cross-sections**

For correct operation of the easyNet network the cable lengths, cross-sections and cable resistances must match those listed in the following table.

Cable length m	Cable resistance mO/m	Cross-section	
		mm <sup>2</sup>	AWG
up to 40	F 140	0.13	26
up to 175	F 70	0.25 to 0.34	23, 22
up to 250	F 60	0.34 to 0.50	22, 21, 20
up to 400	F 40	0.5 to 0.6	20, 19
up to 600	F 26	0.75 to 0.8	18
up to 1000	F 16	1.5	16

The impedance of the cables used must be 120 O.

**h**

The installation of an expensive fibre optic link is recommended with cable lengths > 500 m.

The maximum transmission speed depends on the total length of the network cables, a section "Technical data", page 669.

### Calculating the cable length for a known cable resistance

If the resistance of the cable per unit of length is known (resistance per unit length  $R'$  in  $\Omega/m$ ), the entire cable resistance  $R_L$  must not exceed the following values.  $R_L$  depends on the selected baud rate:

Baud rate	Cable resistance $R_L$
kBaud	$\Omega$
10 to 125	F 30
250	F 25
500 1000	F 12

$l_{\max}$  = Maximum cable length in m.

$R_L$  = Total cable resistance in  $\Omega$ .

$R'$  = Cable resistance per unit length in  $\Omega/m$

$$l_{\max} = \frac{R_L}{R'}$$

### Calculating cross-section with known cable lengths

The minimum cross-section is determined for the known maximum extent of the easyNET network.

$l$  = Cable length in m

$S_{\min}$  = Minimum cable cross-section in  $\text{mm}^2$

$r_{\text{cu}}$  = Resistivity of copper, if not otherwise stated  $0.018 \text{ } \Omega\text{mm}^2/\text{m}$

$$S_{\min} = \frac{l \times r_{\text{cu}}}{12.4}$$

**h**

If the calculation result does not correspond to a standard cross section, take the next higher cross section.

**Calculating length with known cable cross-section**

The maximum cable length for a known cable cross-section is calculated as follows:

$l_{max}$  = Cable length in m

$S$  = Cable cross-section in mm<sup>2</sup>

$r_{cu}$  = Resistivity of copper, if not otherwise stated 0.018 Omm<sup>2</sup>/m

$$l_{max} = \frac{S \cdot 12.4}{r_{cu}}$$

**Connecting the serial multi-function interface**

Each easySafety device is provided on the front with a serial multi-function interface. The interface is factory shipped with a protective cover fitted. Remove this cover carefully.

The serial multi-function interface is used for:

- connecting the programming cable to the COM serial interface on the PC and thus as a connection for the configuration software easySoft-Safety ("PC interface" function).
- the point-to-point connection between an MFD-CP4 (a AWB2528-1548) or MFD-CP8.. in terminal mode (a page 527) and an easySafety device ("device interface" function).
- the point-to-point communication between an MFD-CP8 in COM-LINK mode and an easySafety device ("device interface" function). Information on the COM-Link interface is provided in the manual for MFD-Titan, AWB2580-1480.
- an easySafety memory card ("memory interface" function).

The following shows the permissible programming cables for connecting your easySafety device via the multi-function interface.



### Connection to a PC

Connect one of the following programming cables to the COM or USB interface of your PC and to the serial multi-function interface of the easySafety device.

Table 5: Programming cable for connecting to a PC

Device	Programming cable	Baud rate
easySafety	EASY800-PC-CAB	up to 19.2 KBAud
easySafety	EASY800-USB-CAB	up to 57.6 KBAud

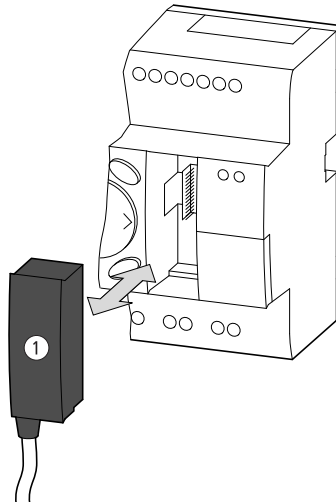

Figure 25: Connecting the programming cable ① to an easySafety device

- x Remove the cover from the interface and fit the connector plug.

# h

#### Caution!

When connecting the programming cable, the easySoft-Safety programming software must be offline. On no account should the programming cable be moved from one easySafety device to another when the connection is online.

### Connecting for point-to-point communication

Connect one of the connection cables from table 6 to an MFD-...-CP8 or MFD-...-CP4 and to the serial multi-function interface of the easySafety device.

Table 6: Connection cable on an MFD-CP4/CP8... for point-to-point communication

Device	Connection cable	Baud rate
easySafety	MFD-800-CAB5 for operation on an MFD-...-CP8	up to 19.2 KBaud
easySafety	MFD-CP4-800-CAB5 for operation on an MFD-...-CP4	up to 19.2 KBaud

h

In order ensure compliance with EMC requirements, the MFD-800-CAB5 cable must not be lengthened.

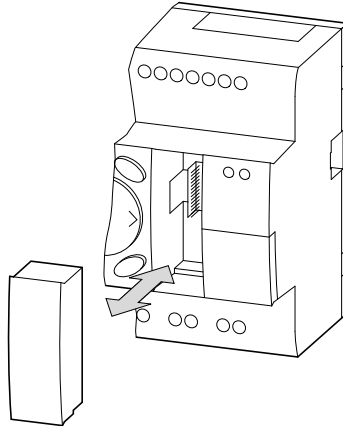

Figure 26: Fitting/removing the interface cover.

X Remove the cover from the interface and connect the connector plug.

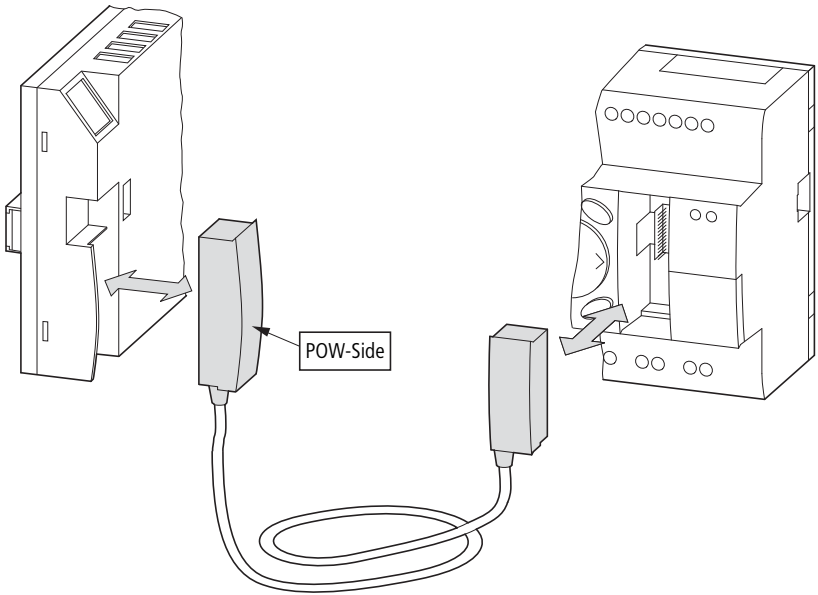

Figure 27: Connecting the connector plug: left MFD-CP..., right easySafety

**h**

The connector marked POW-Side must be plugged into the interface of an MFD. The serial interface only functions if the MFD is providing the power feed required for the interface cable.

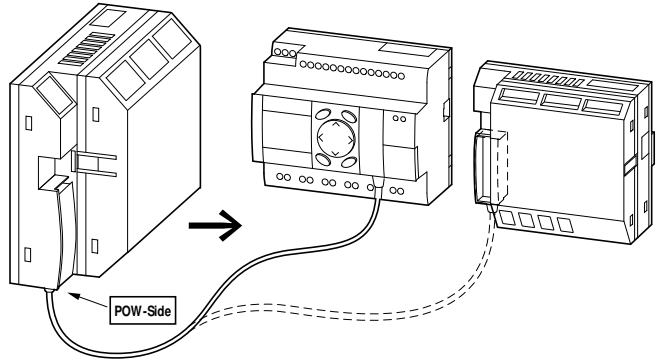

Figure 28: Point-to-point serial interface

### Inserting the memory card

The easySafety devices support the use of memory cards that are fitted into the serial multi-function interface. Each memory card stores a single easySafety configuration.

For easySafety devices, use the ES4A-MEM-CARD1 card.

h

The EASY-M-256K memory card cannot be read or written to by an easySafety device.

X Remove the cover from the interface and connect the connector memory card as shown in figure 29.

h

With easySafety devices you can also remove or insert the memory card when the power supply is switched on without any risk of data loss.

How to use the memory card is explained in section "Transfer from and to the memory card" on page 122.

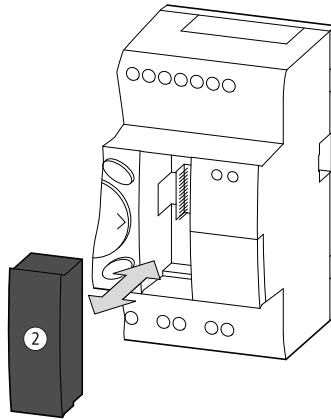

Figure 29: Connecting and removing the memory card ②

### Expanding inputs/outputs

To increase the number of inputs/outputs, you can connect non-safety expansion devices via the easyLink connection of the easySafety devices. These can then be used for the standard circuit diagram:

**j**

#### Danger!

Safety-related data must not be transmitted via the easyLink interface.

All the inputs, outputs and data of the device connected through easyLink must be used only for control functions

Expandable basic units	Expansion units	
ES4P-221-...	EASY618-...-RE	<ul style="list-style-type: none"> <li>• 12 AC inputs,</li> <li>• 6 relay outputs</li> </ul>
	EASY620-...-TE	<ul style="list-style-type: none"> <li>• 12 DC inputs,</li> <li>• 8 transistor outputs</li> </ul>
	EASY202-RE	2 relay outputs, common potential <sup>1)</sup>
Special expansion units for connecting to other bus systems are shown in the latest product catalogue.		

1) Common supply for multiple outputs

### Local standard expansion device

For non-safety expansion, the local expansion unit is positioned directly next to the basic unit.

X Connect the easy expansion with the EASY-LIN-DS connection plug.

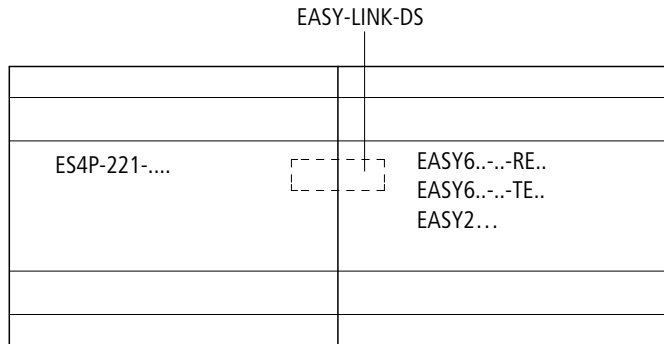

Figure 30: Connecting local expansions with easySafety

**j**

#### **Danger!**

The following electrical isolation is implemented between the ES4P-221-...basic device and the expansion device (isolation always in local connection of expansion device):

- Basic isolation 400 V AC (+10 %)
- Safe isolation 240 V AC (+10 %)

Units may be destroyed if the value 400 V AC +10 % is exceeded, and may cause the malfunction of the entire system or machine!

**h**

Basic unit and expansion unit can be provided with different DC power supplies.

## Remote standard expansion

Remote expansion units can be installed and run up to 30 m away from the basic unit.

# j

### Danger!

The two-wire or multiple-wire cable between the devices must adhere to the insulation voltage requirement which is stipulated for the installation environment. Otherwise, a fault (ground fault, short-circuit) may lead to the destruction of the units or injury to persons.

A cable, such as NYM-0 with a rated operational voltage  $U_e = 300/500$  V AC, is normally sufficient.

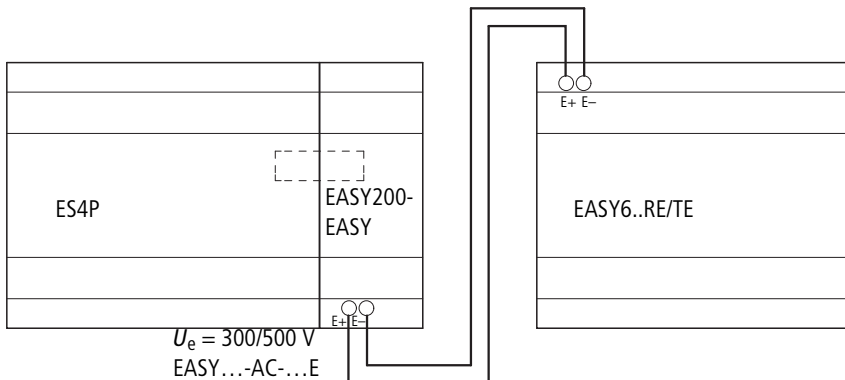

Figure 31: Connecting remote standard expansion devices to easySafety

# h

Terminals E+ and E- of the EASY200-EASY are protected against short-circuits and polarity reversal.

Functionality is only ensured if E+ is connected with E+ and E- with E-.





### 3 Commissioning

---

#### Switching on

Before startup check whether the power supply, inputs, outputs, the serial interface and the easy-NET connection easyLink are properly connected:

- easySafety basic device and 24 VDC expansion unit:
  - Terminal +24 V: Voltage +24 V
  - Terminal 0 V: Voltage 0 V.
  - Terminals IS1 to IS14, R1 to R12 (expansion device): actuation via +24°V.
  - Terminals QR1, QS1-QS4, T1 to T4.
  - Terminals S1-S8 (expansion unit).
- 230 VAC version of local or remote standard expansion:
  - Terminal L: Phase conductor L
  - Terminal N: Neutral conductor N
  - Terminals R1 to R12: Actuation via phase conductor L
  - Terminals S1-S6.

**j**

---

#### **Danger!**

If you have already integrated devices into a system, secure any parts of the system connected to the working area to prevent access and ensure that no-one can be injured if, for example, motors start up unexpectedly.

**Setting the menu language**

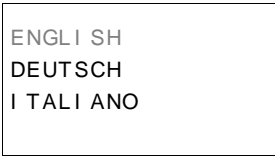

When you switch on the easySafety device for the first time, you will be asked to select the menu language.

- X Use the cursor buttons or to select the language required.
  - English
  - German
  - Italian
  - French

X Press OK to confirm your choice and press ESC to exit the menu.

The device will then switch to the status display.

The menu language setting is a easySafety device function. Even when the safety circuit diagram is deleted, the selected setting is retained.

An easySafety device can manage up to three menu languages at the same time. In addition to the preset menu language, "English", "German" and "Italian" are set as the default second and third menu languages at the factory. The first menu language, "English", is permanently programmed into the device.

You can replace the default menu languages set at the factory with other available menu languages. This is currently French. To do this, load the menu language from easySoft-Safety (Communication View -> Standard Settings) into the device.

**h**

You can change the language setting at a later time, (a section "Changing the menu language", page 583). If you do not set the language, easySafety will display this menu every time you switch on and wait for you to select a language.

## easySafetyoperating modes

### RUN and STOP and BUSY

easySafety has the three operating modes RUN, STOP and BUSY. The device switches operating mode BUSY only temporarily when:

- a configuration transfer with easySoft-Safety is being performed;
- you start the configuration.

In the RUN operating mode, the safety circuit diagram, as well as the possibly wired standard circuit diagram, are executed continuously until you select STOP, the internal device safety monitoring mechanism detects an error or the supply voltage is turned off.

The safety circuit diagram and the parameters are retained in the event of a power failure. All you will have to do is reset the real-time clock after the back-up time has elapsed. In RUN mode:

- the process image of the inputs are read.
- the safety and standard circuit diagram are processed.
- the process image of the outputs is transferred to the physical outputs.

In STOP mode neither the safety nor the standard circuit diagram are run. Only in this mode is circuit diagram entry, modification of the system parameters or configuration of the easyNet possible. It is also possible to store the safety and standard circuit diagram on the external memory card or load them from the external memory card. In this mode, a circuit diagram can also be transferred from and to easySoft-Safety.

SECURITY . . .
DEFAULT . . .
STOP RUN
SET CLOCK

The switch from RUN to STOP and vice versa is carried out in the main menu.

# j

**Danger!**

In RUN mode an easySafety device will immediately run the saved safety and standard circuit diagram in the unit when the power supply is switched on.

The outputs are activated according to the switch logic of the circuit diagram.

Configure your machine/plant so that the automatic starting of the easySafety device never causes unintentional starting of the machine/plant concerned.

Create your safety circuit diagram so that after the power supply is switched on, there is always a defined safety startup behaviour. Information on startup behaviour is provided on page 592.

The device does not start with RUN mode if you deactivate RUN MODE (exception: devices without display).

easySafety devices without display and operator buttons have a different startup behaviour. The RUN MODE and CARD START functions are activated automatically in this case, since no device operations for manual starting are possible.

If the easySafety devices without a display do not contain an safety circuit diagram, but this is stored on the memory card, this is loaded automatically after startup. The device will then process the circuit diagram in RUN mode.

## The first circuit diagram

The following is a step-by-step example of how to wire your first standard circuit diagram and first safety circuit diagram. In this way you will learn all the rules, quickly enabling you to use a easySafety device for your own projects.

Normally you wire the safety circuit diagram following the procedure described here. However, certain rules must be observed here and these are explained fully in section "Rules in the safety circuit diagram" on page 341. The following shows the most important rules for creating your first standard circuit diagram and the first safety circuit diagram.

**i**

### Warning!

#### Important rules for the first safety circuit diagram

- Wire coils ...lx of the safety function blocks directly to the contacts of the device inputs ISx. Branches and wiring to other contacts are not allowed!
- Inputs IS.. for which the debounce function is set must not be used in the safety circuit diagram.
- Inputs IS.. may be used in the safety circuit diagram and in the standard circuit diagram at the same time.
- A safety device output such as QS2 can either be used only in the safety circuit diagram or in the standard circuit diagram as a coil, i.e. a safety output that was used in the safety circuit diagram is then no longer available for use in the standard circuit diagram and vice versa.
- A safety device output must only be used once as a coil in the safety circuit diagram.

**j**

### Danger!

Device outputs QR and QS that are set by the standard circuit diagram are not safety outputs and must only be used for standard tasks. Make sure that these outputs do not trigger any safety-related actions on the machine or plant.

As with conventional wiring, you use contacts and relays in the diagram.

The easySafety device saves you having to use and wire different components. At the push of a few buttons, the easySafety circuit diagram produces all the wiring required. All you have to do is then connect any switches, sensors, lamps or contactors you wish to use.

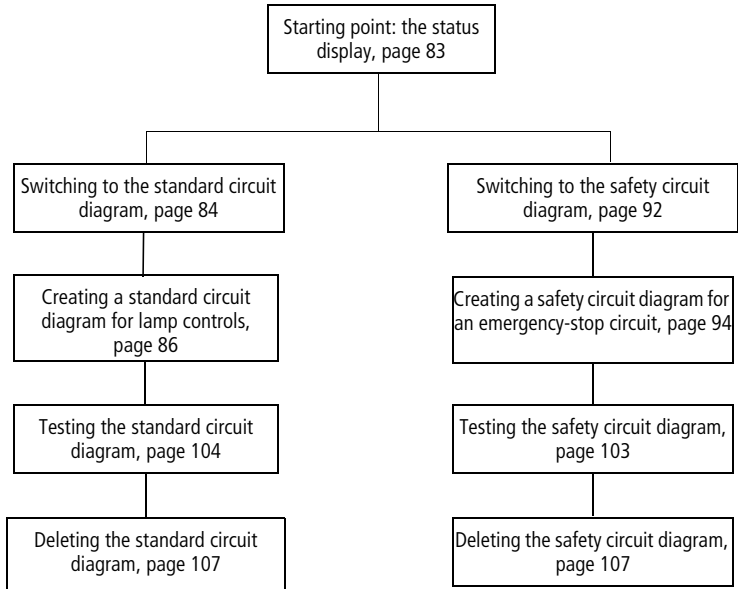

Figure 32: Overview for “first circuit diagram”

**Starting point: the status display**

```

I S . . . . .
      I           P-
MO 02:00
QR.  QS. . . . STOP

```

When you switch on an easySafety device, it opens the status display immediately. This status display shows the switching state of the inputs and outputs and also indicates whether the device is currently running a (safety) circuit diagram.

**Requirement for circuit diagram entry:** the easySafety device must be in STOP mode.

h

The examples do not involve the use of expansion devices. If an expansion unit is connected, the status display will first show the status of the basic unit and then the status of the expansion unit before showing the first selection menu.

```

SECURITY...
DEFAULT...
STOP RUN
PARAMETER

```

x Press OK to switch to the main menu.

The SECURITY menu option is selected on the easySafety device.

In general, press OK to switch to the next menu level, and press ESC to move one level back.

h

OK has two other functions:

- Press OK to transfer the modified setting values in Entry mode.
- In the circuit diagram, you can also press OK to insert and modify contacts and relay coils.

### Switching to the standard circuit diagram

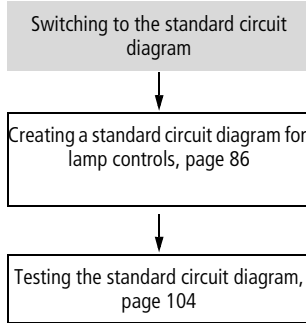

SECURITY...  
 DEFAULT...  
 STOP RUN  
 PARAMETER

X Use the cursor button to change to the STANDARD... menu option.

PROGRAM...  
 PARAMETER...

X Press OK 2 x to access the circuit diagram display via menu options PROGRAM -> CIRCUIT DIAGRAM. This is where you can create the standard circuit diagram.

CIRCUIT DIAGRAM  
 FUNCTION RELAYS  
 DELETE PROGRAM



### Circuit diagram display for the standard circuit diagram

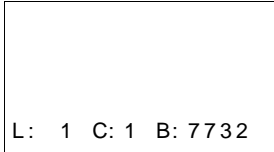



The circuit diagram display is currently empty. The cursor flashes at the top left, which is where you will start to create your diagram.

The position of the cursor appears in the last line of the display:

- L: = Rung (**L**ine).
- C: = Contact or coil field (**C**olumn).
- B: = Amount of free memory in **B**ytes.

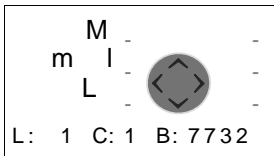
The standard and safety circuit diagram supports four contacts and one coil in series. The display shows 6 fields of the circuit diagram.



Use the  cursor buttons to move the cursor over the invisible circuit diagram grid. The first four columns are contact fields, the fifth column is a coil field. Each line is a circuit connection. easySafety automatically connects the contact to the power supply.

X Now wire the circuit diagram as described below.

### Creating a standard circuit diagram for lamp controls

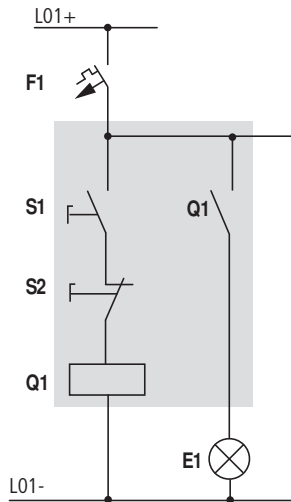
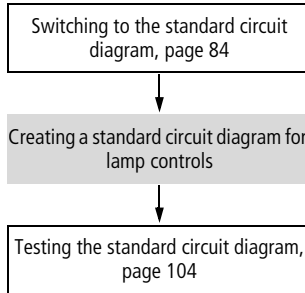

Figure 33: Lamp controller with relays

In the following example, the easySafety device carries out all the wiring and performs the tasks of the circuit diagram shown below.

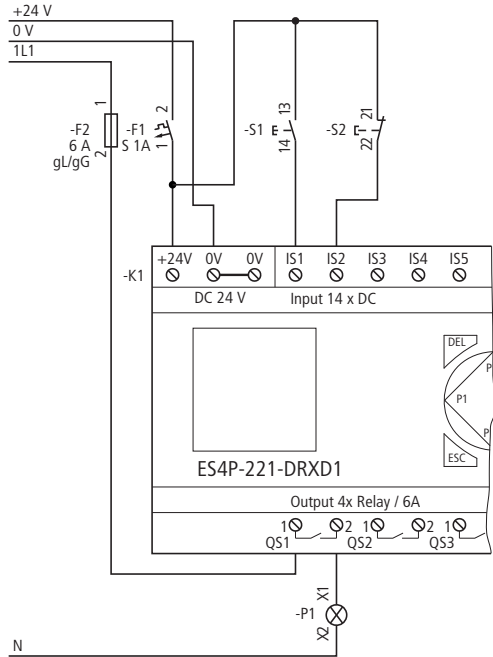

Figure 34: Lamp control with an easySafety device

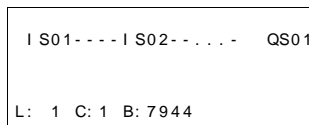

Figure 35: Standard circuit diagram with inputs I S01, I S02 and output QS01

With this example the switches S1 and S2 are at the input. I S01 and I S02 are the switch contacts for the input terminals in the standard circuit diagram.

The relay Q1 is represented in the standard circuit diagram by the relay coil QS01.

The symbol identifies the coil's function, in this case a relay coil acting as a contactor. QS01 is one of the easySafety device's outputs.

**From the first contact to the output coil**

With easySafety devices wire from the input to the output. The first input contact is I S 0 1 .

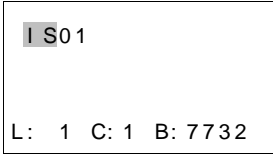

X Press OK.

easySafety proposes the first contact I S 0 1 at the cursor position.

I S flashes and can be changed, for example, to a P (for a pushbutton input) by using the cursor buttons or . However, nothing needs to be changed at this point.

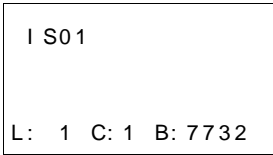

X Press OK 2 x, to move the cursor across the 0 1 to the second contact field.

You could also move the cursor to the next contact field using the cursor button.

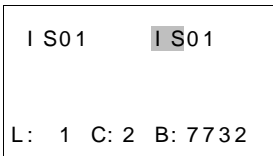

X Press OK.

Again, easySafety inserts a contact I S 0 1 at the cursor position.

X Press OK so that the cursor jumps to the next position and press cursor button or to change the number to 0 2 .

**h**

Press DEL to delete a contact at the cursor position.

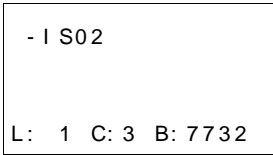

X Press OK to move the cursor to the third contact field.

You do not need a third relay contact, so you can now wire the contacts directly up to the coil field.

## Wiring

A easySafety device displays a small arrow in the standard circuit diagram and in the safety circuit diagram when creating the wiring.

Press ALT to activate the wiring arrow cursor and use the cursor buttons to move it. Pressing ALT once more switches the cursor back to Move mode.

h

ALT also has two other functions depending on the cursor position:

- In the left contact field, you can press ALT to insert a new empty circuit connection.
- The contact under the cursor can be changed between a make and break contact by pressing the ALT button.

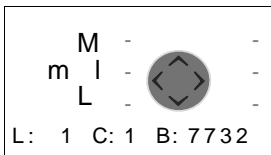

The wiring arrow works between contacts and relays. When you move the arrow onto a contact or relay coil, it changes back to the cursor and can be reactivated if required.

h

The easySafety device automatically connects adjacent contacts up to the coil.

X Press ALT to wire the cursor from I S02 through to the coil field.

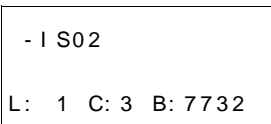

The cursor changes into a flashing wiring arrow and automatically jumps to the next logical wiring position.

X Press the cursor button . Contact I S02 will be connected up to the coil field.

h

You can use DEL to erase a connection at the cursor or arrow position. Where connections intersect, the vertical connections are deleted first, then, if you press DEL again, the horizontal connections are deleted.

X Press the cursor button again.

The cursor will move to the coil field.

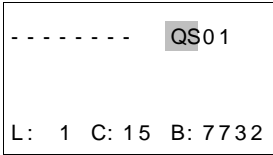

X Press OK.

The specified coil function and the output relay QS0 1 are correct and do not have to be changed.

j

**Danger!**

Device outputs (QS., QR.) used in the standard circuit diagram are not safety outputs, and may only be used for standard outputs. Make sure that these outputs do not trigger any safety-related actions on the machine or plant.

Your result will look as follows:

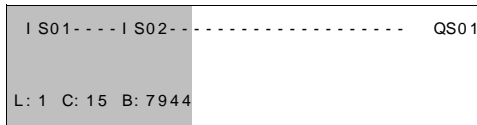

Figure 36: Your first wired and functional circuit diagram

■ = Visible area

X Press ESC to leave the circuit diagram display.  
The SAVE menu appears.

## Saving

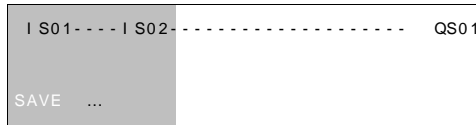

Figure 37: SAVE menu

 = Visible area

X Confirm with OK.

The circuit diagram is stored.

X Press the ESC button twice to return to the main menu.

Once you have connected pushbutton S1 and S2, you can test your circuit diagram straight away.

After you have created the safety circuit diagram, you should check both the safety circuit diagram and the standard circuit diagram. To learn how to do this, see section "Testing the standard circuit diagram" on page 104.

### Switching to the safety circuit diagram

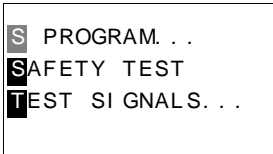
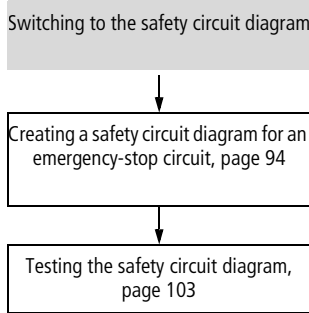

x Press OK to enter S PROGRAM via the selected SECURITY menu option.

The password (a password protection) is requested as soon as you move to an entry point

x With the OK button, change to the safety circuit diagram.

Password protection: If you have not yet assigned a master password (M password) you will now be requested to do this in order to reach the display of the safety circuit diagram. Information on password assignment is provided on page 567.

If you have already assigned the master password (M password), you will only be asked to enter the password if you wish to change the safety circuit diagram. As soon as you open a contact or coil field with OK, you must enter the defined M password.

Password protection is automatically reactivated if you do not make any changes to the safety configuration of an easySafety device for 30 minutes.



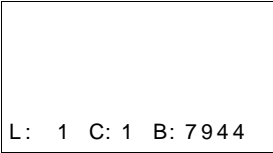

L: 1 C: 1 B: 7944

### Circuit diagram display for the safety circuit diagram

The circuit diagram display is currently empty. Start the wiring at the blinking cursor position in the upper left. The display is a precise representation of the standard circuit diagram. [a](#) page 85

Now try to wire up the following diagram, [a](#) section "Creating a safety circuit diagram for an emergency-stop circuit" on page 94.

## Creating a safety circuit diagram for an emergency-stop circuit

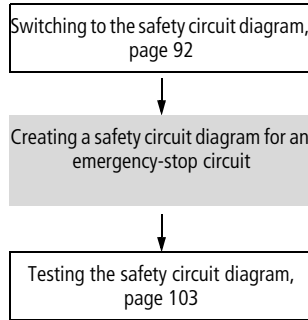

The easySafety device is required to monitor the activation of an Emergency-Stop pushbutton and switch off the machine via a load contactor using the ES.. (Emergency Stop, a page 371) safety function block.

To do this, the Emergency-Stop pushbutton is wired via the easySafety device terminal IS07 to the function block input ES..I1 (coil). The function block output, contact ES..QS, controls a load contactor via the easySafety device output QS02. This load contactor switches the machine. This load contactor switches the machine.

The rules to be observed are provided in the description of the safety function blocks (a section "Rules in the safety circuit diagram" on page 341).

The example contains a single-channel emergency-stop circuit.

ES.. is used here in Manual Start (MST) mode.

After the Emergency-Stop button is executed and later mechanically released, you should be able to reset the ES.. safety function block via a Reset button. For this the Reset button is wired via the easySafety device terminal IS08 to function block input ES..RE.

The functional machine safety of the example shown here complies with architecture of category 1 in accordance with EN ISO 13849-1.

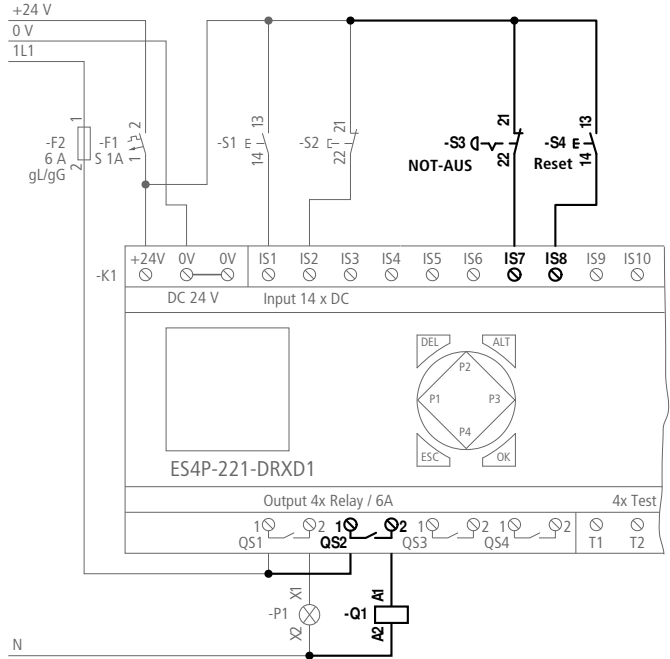

Figure 38: easySafetyEmergency-stop circuit with an device (safety area highlighted in the graphic)

In the safety circuit diagram you wire from the input to the output, exactly like in the standard circuit diagram.

I S07-----	ES01 I 1
I S08-----	ES01 RE
ES01 QS-----	QS02
L: 1 C: 1 B: 7944	

Figure 39: Safety circuit diagram with inputs I S07, I S08, safety function block ES01 and output QS02

**From the first contact to the output coil**

At the start of the wiring, the flashing cursor is positioned in line 1 (L:1), column 1 (C:1) of the empty circuit diagram.

The first input contact is to be I S07 which activates the emergency-stop function block via function block coil ES..I1.

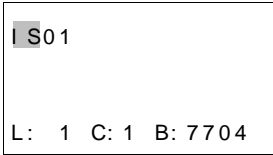

X Press OK.

easySafety proposes the first contact I S01 at the cursor position.

I S flashes and can be changed, for example, to a QR01 using the cursor buttons or for reading an output. However, nothing needs to be changed to the setting IS apart from the number. Press to enter the number field and press sixtimes to change the input number from IS01 to IS07.

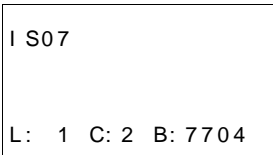

X Press OK once to complete the selection, move the cursor across the 07 to the next field and then wire the input I S07.

**h**

Press DEL to delete a contact at the cursor position.

## Wiring

A easySafety device displays a small arrow I, the same tool as already in the standard circuit diagram, the wiring arrow (a page 89).

### 1rd circuit diagram line

X Press ALT to activate the wiring arrow.

The cursor changes into a flashing wiring arrow and automatically jumps to the first logical wiring position.

X Press cursor button four times so that the contact IS07 is wired up to the coil field .

The cursor moves to the coil field which it indicates by showing a flashing square instead of the wiring arrow .

I S07

L: 1 C: 2 B: 7704

## h

You can use DEL to erase a connection at the cursor or arrow position. Where connections intersect, the vertical connections are deleted first, then, if you press DEL again, the horizontal connections are deleted.

X Press OK to switch to Entry mode.

The set coil function is correct, but the device safety output QR which is now flashing as an unfixd coil name is not. In this example the contact IS07 will be wired with the function module input of coil ES..I1.

The output relay QR01 must therefore be changed to ES01 I 1.

X Press the cursor button or until the function block ES.. appears in the coil field.

The coil name ES will flash and the proposed coil number 01 and function block input I 1 are displayed continuously.

X Press OK to select the function block ES as an operand via the coil name.

The cursor moves to coil 01 and flashes.

X Press OK, to define function block ES01 via the following coil number 01.

----- QR01

L: 1 C: 5 B: 7704

----- ES01 I 1

L: 1 C: 5 B: 7704

```

ES01 NEN MST *
      *** 2CH
>DT 3.0s
    
```

When using the function block in the circuit diagram for the first time, press OK to enter the general display of the function block parameters automatically (see figure on the left). In this way, this function block is stored in the easySafety device which simplifies its further use. Set the parameters for the ES.... safety function block in this example in the function block editor. The first parameter NEN that can be changed flashes in Entry mode.



X As the function block is to be activated without the need of an external enable, do not change this parameter and move to the next parameter MST by pressing the  cursor button or OK.

X As a Manual Start (MST) is also required, move on to the evaluation parameter.

The default setting for 2-channel evaluation (2CH) should be set to single-channel evaluation.

```

ES01 NEN MST *
      *** 1CH
>DT 3.0s
    
```

X Use the cursor button  or  to move to parameter 1CH.

X The parameter setting for the function block is now completed so press ESC to move back to the circuit diagram display.

```

----- ES01 I 1

L: 1 C: 5 B: 7704
    
```

The function block input, coil I1, will now flash in Entry mode. As this is the function block input required, this circuit diagram line is complete.

X Press OK to close the entry in this circuit diagram line and automatically move to the next line.

**2nd circuit diagram line**

The second input contact is to be I S08 which re-enables the activated function block via function block coil ES..RE.

```

I S07-----
I S08-----
L:  2  C: 1  B: 7704

```

X Press OK.

easySafety proposes the first contact I S01 at the cursor position and causes the contact name I S to flash.



X Press OK once more.

X Use the  cursor button to choose contact number 08 and therefore safety input I S08, to which the reset pushbutton is connected.

X Press OK to complete the selection and move to the next field in order to wire input I S08 next.

X Press ALT to activate the wiring arrow and proceed as described above for the first circuit diagram line.

Wire again up to the coil field and press OK to activate Entry mode.

X Press the cursor button  or  up to the function block coil ES0111 in the coil field.

```

----- ES0111
----- ES0111
L:  2  C: 5  B: 7704

```



As this function block is already in the easySafety device you can simply move to the function block input.

X Press cursor  twice until the cursor flashes on function block input I1.

```

----- ES0111
----- ES01RE
L:  2  C: 5  B: 7704

```

X Press the cursor button  or  until the Reset coil RE function block input is selected.

X Press OK to close the entry in this circuit diagram line and automatically move to the next line.

### 3rd circuit diagram line

This is used as a contact of the function block output - contact ES01..QS. This is associated directly with the safety device output QS.

X Press OK.

easySafety enables the first contact I S0 1 at the cursor position and causes the contact name I S to flash.

I S07- - - - -
I S08- - - - -
<b>ES01QS- - - - -</b>
L: 3 C: 1 B: 7704

X Use cursor buttons or to select contact ES01QS.

X Press cursor button three times to complete the selection, move the cursor across the 01 to the next field and then wire the contact ES01QS.

X Press ALT to activate the wiring arrow and proceed as described above for the first circuit diagram line.

Wire again up to the coil field and press OK to activate Entry mode. The proposed coil function is correct, the flashing device safety output QR must be changed to QS.

- - - - -	ES01 I 1
- - - - -	ES01 RE
- - - - -	QS02
L: 3 C: 5 B: 7704	

X Press the cursor button until the function block QS01 appears in the coil field.

X Press OK so that the cursor jumps to the next position and press cursor button to change to the number 0 2 .

X Press OK in order to complete the entry in this circuit diagram line and thus complete the entire example circuit diagram.

Your result will look as follows:

I S07- - - - -	ES01 I 1
I S08- - - - -	ES01 RE
ES01QS- - - - -	QS02
L: 1 C: 1 B: 7704	

Figure 40: Your first wired and functional safety circuit diagram

■ = Visible area

X Press ESC to leave the circuit diagram display. The SAVE menu appears.



## Saving

I S07-----	ES011 1
I S08-----	ES02RE
ES01QS-----	QS02
SAVE ...	

Figure 41: SAVE menu of the safety circuit diagram

■ = Visible area

X Press the OK button.

The safety circuit diagram is stored.

X Press the ESC button twice to return to the main menu.

h

easySafety cannot be started without a safety circuit diagram entered.

**Testing the rules of the safety circuit diagram (plausibility check)**

Requirement: the easySafety must be in STOP mode.

Use the SAFETY TEST function to test whether your circuit diagram complies with the rules for safety circuit diagrams (a section "Rules in the safety circuit diagram" on page 341).

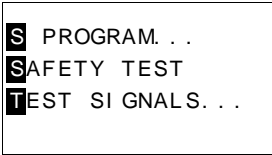

- X Use cursor button to move to SAFETY TEST.
- X Press OK to start the test.

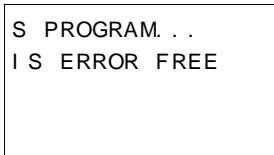

The successful testing of this example program is indicated by the display shown on the left.

j

**Danger!**

The SAFETY TEST function only checks whether the safety circuit diagram complies with the rules for creating the safety configuration. The test does not indicate whether your machine/plant is functioning safely.

Test the safety equipment of your machine/plant!

## Testing the safety circuit diagram

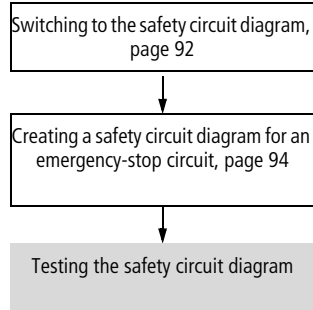

Once you have connected the Emergency-Stop button and the Reset button, you can test your circuit diagram.

**h**

The procedure to follow during testing and when switching the power flow display of a safety circuit diagram on/off matches the following description of how to test a standard circuit diagram.

### Testing the standard circuit diagram

Requirement: a safety circuit diagram has already been created a page 92.

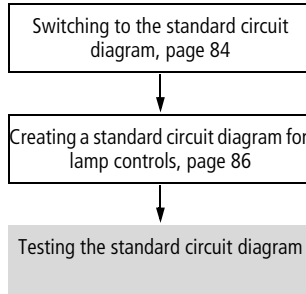

```

PROGRAM . . .
STOP RUN
PARAMETER
SET CLOCK . . .
  
```

X Switch back to the main menu and select the STOP RUN menu option.

The current operating mode is indicated in the device display by a tick at RUN or STOP stop. Pressing the OK button enables you to toggle between the modes.

X Press the OK button in order to change to RUN.

h

The status display shows the current mode as well as the switching states of the inputs and outputs.

### Test using the status display

```

I S12 . . . . .
      I           P-
MO 14: 42
QR. QS1 . . .   RUN
  
```

X Change to the status display and press pushbutton S1. Do not execute pushbutton S2.

The contacts for inputs IS1 and IS2 are activated and relay QS1 picks up, indicated by the highlighted numbers.

### Test using the power flow display

A easySafety device enables you to check the power flow in RUN mode. While the device is processing the circuit diagram in RUN mode, you can use the integrated power flow display to check this.

X Change to the circuit diagram display and press pushbutton S1.

The relay picks up and the easySafety displays the power flow with a double line.

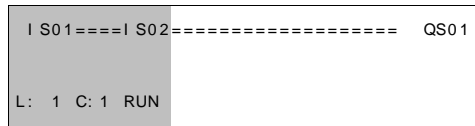

Figure 42: Power flow display: Inputs I S1 and I S2 are closed, relay QS1 has picked up

■ = Visible area

X Press pushbutton actuator S2, that has been connected as a break contact.

The power flow is interrupted and relay Q1 drops out.

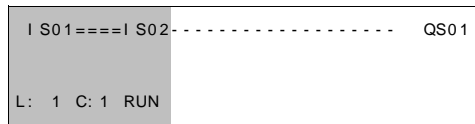

Figure 43: Power flow display: Input I S01 is closed, input I S02 is open, relay QS1 has dropped out

■ = Visible area

X Press ESC to return to the Status display.

h

The standard circuit diagram does not have to be completed in its entirety so that it is possible to test parts of it.

The easySafety device simply ignores any incomplete standard wiring that is not yet working and only uses the finished wiring.

**Power flow display with Zoom function**

With the easySafety device you can check the following at a glance:

- All four contacts plus one coil in series
- 3 Rungs/Current paths

X Change to the circuit diagram display and press the ALT button. Press pushbutton S1.

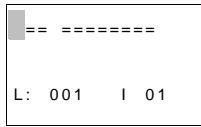

Figure 44: Power flow display in Zoom function: Input IS01 and IS02 are closed, relay QS1 has picked up

Contact closed, coil is triggered:

# Contact opened, coil not triggered.

X Press pushbutton S2, that has been connected as a break contact.

The power flow is interrupted and relay QS1 drops out.

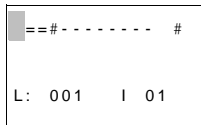

Use the cursor buttons to move between the contacts or coil.

X Press the cursor button .

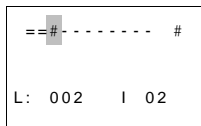

The cursor moves to the second contact.

X Press the ALT button. The display changes to display status with contact and/or coil designation.

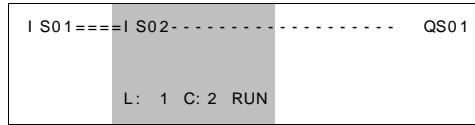

Figure 45: Power flow display: Input I S01 is closed, input I S02 is open, relay QS1 has dropped out

■ = Visible area

### Deleting the standard circuit diagram

X Switch the easySafety device to STOP mode.

h

In order to expand, delete or modify the standard circuit diagram, easySafety must be in STOP mode.

X Choose STANDARD -> PROGRAM... to switch from the main menu to the appropriate menu level.

X Select DELETE PROGRAM

The easySafety will display the prompt DELETE?.

X Press OK to delete the program or ESC to cancel.

X Pressing ESC once more returns you to the previous menu level.

CIRCUIT DIAGRAM  
FUNCTION RELAYS  
DELETE PROGRAM

### Deleting the safety circuit diagram

You can delete the safety circuit diagram using the DELETE ALL function in the system menu.

h

The DELETE ALL function is used to delete the safety circuit diagram and standard circuit diagram.





## 4 Wiring with easySafety

This chapter describes the entire range of functions of an easySafety device.

### easySafety operation

### Buttons for editing circuit diagrams and function blocks



Delete rung, contact, relay or empty rung in the circuit diagram



Toggle between n/o and n/c contact  
Connect contacts, relays and rungs  
Add rungs



Change value  
Move cursor up/down  
Change place  
Cursor left/right

Cursor buttons set as P buttons:

Input P1,

Input P2

Input P3,

Input P4



Undo setting from last **OK**  
Leave current display, menu



Change, add new contact/relay,  
Save setting

## Operation

The cursor buttons in the easySafety circuit diagram have three functions:

- Moving.
- Input.
- Connecting.

The current mode is indicated by the appearance of the flashing cursor.

In Move mode, use **←** to position the cursor on the circuit diagram in order to select a rung, a contact or a relay coil.

I S01

Press **OK** to switch to Entry mode so that you can enter or change a value at the cursor position. Press **ESC** in Entry mode to restore easySafety to the last changes of an entry.

Press **ALT** to switch to Connect mode for wiring contacts and relays. Press **ALT** again to return to Move.

Press **ESC** to exit the circuit diagram and parameter display.

h

The easySafety device performs a large part of this cursor change automatically. For example it switches the cursor to Move mode when it is no longer possible to make an entry or connection at the selected cursor position.

---

**Circuit diagram elements    Configuration**

A configuration is a series of commands that the easySafety device processes cyclically in RUN mode. A easySafety configuration consists of the necessary settings for the device, easyNet, password, system settings, at least a circuit diagram and function blocks.

A circuit diagram is the part of the configuration in which the contacts are connected together. In RUN mode, a coil is switched on or off depending on the power flow and coil function set.

The configuration of easySafety consists of:

- Safety circuit diagram containing the safety function for implementing safety-related tasks.
- Standard circuit diagram for implementing the general, non-safety tasks of the control relay.

**Safety-relevant tasks**

The term “safety circuit diagram” is given to the fail-safe part of the easySafety configuration. The safety circuit diagram consists of contacts and coils of the safety basic devices which are wired together. Contacts can, for example, be the inputs of the easySafety device or outputs of safety function blocks. Coils can, for example, be outputs of the basic unit or inputs of safety function blocks. Special measures are implemented to ensure that the safety function blocks operate error-free. The function blocks continuously read the current state of the connected safety transmitters and process this information. On the basis of the result, the safety circuit diagram removes or issues the enable via one of the device safety outputs (QS., QR..) for a particular function.

### Non-safety-relevant tasks

Certain inputs/outputs of safety function blocks can be connected in the safety circuit diagram or also in the standard circuit diagram. The device safety inputs can also be read and processed in the standard circuit diagram. The result is output via safety outputs which however, CANNOT be used in the safety circuit diagram.

An internal management function prevents the accidental double use of these outputs (QS., QR..).

j

#### **Danger!**

Device outputs (QS., QR.) that are used in the standard circuit diagram are not safety outputs and must only be used for standard tasks. Make sure that these outputs do not trigger any safety-related actions on the machine or plant.

The safety circuit diagram cannot access the data of the standard circuit diagram in order to prevent the processing of non-safety data in the safety circuit diagram.

Conversely, the standard circuit diagram only has indirect access to the safety circuit diagram. In the standard circuit diagram you can therefore:

- use diagnostic function blocks to evaluate signals of the non-safety diagnostic outputs of the safety function blocks, a page 237.
- evaluate the error contact ER of a safety function block for signalling a general fault, a page 345.
- activate or deactivate safety function blocks as required, a page 345.

The relationship between the safety and standard circuit diagram must observe the rules specified for the creation of safety circuit diagrams (a page 341). Check that these rules are observed by choosing the SAFETY TEST menu option.

The easySafety control relay can be connected locally or via easyNet with a non-safety I/O expansion device. These non-safety I/Os are only read, processed and written by the standard circuit diagram.

Further information on expansion options is provided in chapter "Expanding an easySafety device" from page 627 as well as in chapter "Introduction to the easyNet network", on page 521.

**h**

A easySafety device is primarily a configurable safety relay, and this is why the safety circuit diagram is obligatory. Without it, the device could not fulfill any safety function and therefore any configuration without a safety circuit diagram is rejected as invalid.

### Function blocks

Function blocks are program blocks with special functions. Examples: emergency-stop relays, timing relays, time switches. Function blocks are provided with or without contacts and coils. How a safety or standard function block is added to the safety or standard circuit diagram and parameterised is described in „Working with function blocks“ on page 155.

In RUN mode the function blocks are processed according to the circuit diagram and the results are updated accordingly.

Examples:

Timing relay = Function block with contacts and coils

Time switch = Function block with contacts

### Relays



Relays are switching devices that are emulated in easySafety device electronically, which activate their contacts according to the assigned function. A relay consists of at least one coil and contact.

### Contacts

Contacts are used to change the power flow inside the easySafety circuit diagram. Contacts such as make contacts are set to 1 when they are closed and 0 when they are opened. In the easySafety circuit diagram you can wire contacts as make or break contacts.

An easySafety device operates with different contacts that you arrange in any order in the contact fields of the safety or standard circuit diagram.

Table 7: Usable contacts

Contact	easySafety representation
 N/O contact, open in release position	I , QS, MS, ...
 N/C contact, closed in release position	, , , ...

A detailed list of all contacts used in the standard and safety circuit diagram is provided on page 643.

### Coils

Coils are the actuating mechanisms of relays. The results of the wiring are transferred to the coils when the device is in RUN mode. These switch to the On (1) or Off (0) state according to these results. Coils can have seven different coil functions which is explained in greater detail on page 145.

A easySafety device is provided with different types of relays and function blocks which can be wired in a circuit diagram via their coils (inputs).

The switching of the relays is set by means of coil functions and parameters.

h

All coils in the safety circuit diagram have the contactor coil function!

The options for setting output and marker relays are listed with the description of each coil function.

The coil functions and parameters for the function blocks are explained with the description of each function block.

h

A detailed list of all contacts used in the standard and safety circuit diagram is provided on page 643.

## Markers

The term “marker” generally refers to the standard marker bit (M). easySafety devices also process safety marker bits (MS), marker bytes (MB), marker words (MW) and marker double words (MD). Standard markers are used in the appropriate format for the intermediate storage of data. The standard marker bits are used accordingly to store Boolean states 0 or 1. Safety marker bits (MS) are used exclusively in the safety circuit diagram. Marker bit (M), marker bytes (MB), marker words (MW) and marker double words (MD) are used in the safety circuit diagram.

Table 8: Standard markers

Markers	easySafety display	Number	Value range	Access type r = read w = write
Marker 32 bit	MD	01-96	32 Bit	r, w
Marker 16 bit	MW	01-96	16 Bit	r, w
Marker 8 bit	MB	01-96	8 Bit	r, w
Safety markers 1 bit	MS	1-32	1 Bit	r, w
Standard markers 1 bit	M	1-96	1 Bit	r, w

To use the standard markers MD, MW and MB as required for the binary operands (contacts), the following rules must be observed:

Table 9: Composition of the standard markers

Marker range that can be declared as retentive	Bit (M)	96-89	88-81	80-73	72-65	64-57	56-49	48-41	40-33	32-25	24-17	16-9	8-1
	Byte (MB)	12	11	10	9	8	7	6	5	4	3	2	1
	Word (MW)	6		5		4		3		2		1	
	D-Word (MD)	3				2				1			
	Byte (MB)	24	23	22	21	20	19	18	17	16	15	14	13
	Word (MW)	12		11		10		9		8		7	
	D-Word (MD)	6				5				4			
	Byte (MB)	36	35	34	33	32	31	30	29	28	27	26	25
	Word (MW)	18		17		16		15		14		13	
	D-Word (MD)	9				8				7			
	Byte (MB)	48	47	46	45	44	43	42	41	40	39	38	37
	Word (MW)	24		23		22		21		20		19	
	D-Word (MD)	12				11				10			
	Byte (MB)	60	59	58	57	56	55	54	53	52	51	50	49
	Word (MW)	30		29		28		27		26		25	
	D-Word (MD)	15				14				13			
	Byte (MB)	72	71	70	69	68	67	66	65	64	63	62	61
	Word (MW)	36		35		34		33		32		31	
	D-Word (MD)	18				17				16			
	Byte (MB)	84	83	82	81	80	79	78	77	76	75	74	73
	Word (MW)	42		41		40		39		38		37	
	D-Word (MD)	21				20				19			
	Byte (MB)	96	95	94	93	92	91	90	89	88	87	86	85
	Word (MW)	48		47		46		45		44		43	
D-Word (MD)	24				23				22				



Marker range that can not be declared as retentive	Word (MW)	54	53	52	51	50	49
	D-Word (MD)	27		26		25	
	Word (MW)	60	59	58	57	56	55
	D-Word (MD)	30		29		28	
	Word (MW)	66	65	64	63	62	61
	D-Word (MD)	33		32		31	
	Word (MW)	72	71	70	69	68	67
	D-Word (MD)	36		35		34	
	Word (MW)	78	77	76	75	74	73
	D-Word (MD)	39		38		37	
	Word (MW)	84	83	82	81	80	79
	D-Word (MD)	42		41		40	
	Word (MW)	90	89	88	87	86	85
	D-Word (MD)	45		44		43	
	Word (MW)	96	95	94	93	92	91
	D-Word (MD)	48		47		46	
D-Word (MD)	51		50		49		
D-Word (MD)	...		...		...		
D-Word (MD)	96		...		...		

## h

Avoid any accidental double assignment of standard markers since it is possible to access physically identical memory ranges with different marker operands. table 9 illustrates the marker allocation. For example, it is also possible to accidentally access the 96 standard marker bits via the first 12 marker bytes (MB), 6 marker words or 3 marker double words at the same time and therefore produce undefined states. With successive accesses within an MD, such as to MD1, MW2, MB4 or standard M32, the last write operation is retained.

Tip: By using marker bytes starting from MB13, marker words starting from MW07 and marker double words starting from MD04, double assignments with standard marker bits M01-M96 are prevented.

**Retentive standard markers**

You can declare a freely definable contiguous range of marker bytes within the range MB01-MB96 as retentive. The table 9 shows how together with these marker bytes MB01-MB96, also marker words MW01-48 and marker double words MD01-24 can be declared as retentive.

The remaining marker words MW49-96 and marker double words MD25-96 cannot be declared as retentive!

The conditions by which the retentive data of a device is deleted are described in a section "Retention" on page 597).

**Number formats**

The easySafety device processes calculations with a signed 31-bit value.

The value range is:

$-2147483648$  to  $+2147483647$

With a 31-bit value, the 32nd value is the sign bit.

Bit 32 = status 0 -> positive number.

Example:

$00000000000000000000010000010010_{\text{bin}} =$

$412_{\text{hex}} = 1042_{\text{dec}}$

Bit 32 = status 1 -> negative number.

Example:

$11111111111111111101110010101110_{\text{bin}} =$

$\text{FFFDCAE}_{\text{hex}} = -2147474606_{\text{dec}}$

**h**

The values of the data types marker byte (MB) and marker word (MW) are processed as unsigned. This must be remembered particularly if you wish to transfer the output of a standard function block which can take on negative values to the input of a standard function block and wish to buffer the value in the marker range.

If a used variable can take on negative values and you wish to store this in the marker range, you must assign a marker double word for it.

---

## Circuit diagram display

You wire contacts and coils of relays in the easySafety circuit diagram from left to right, from the contact to the coil. The standard circuit diagram is entered in an invisible wiring grid with contact fields, coil fields and rungs, and wired together with connections. easySafety enables you to create a safety circuit diagram for the functions as a configurable safety relay safety relay that is kept separate from the standard circuit diagram that is also provided for general control tasks. The safety circuit diagram is organised with contact fields, coil fields and rungs in the same way as the standard circuit diagram.

- Insert contacts in the four **contact fields**. The first contact field on the left is automatically connected to the voltage.
- In the **coil field** the relay coil to be controlled is entered with the coil identifier and coil function. The coil identifier consists of the coil name, coil number and, in the case of function blocks, with the function identifier. The coil function defines the operation of the coil.
- Each line in the circuit diagram represents a **rung**. In a configuration of the easySafety device, up to 256 rungs can be wired. These can be divided up between the safety and standard circuit diagram as required. The editor counts the rungs used and shows the number of rungs available in the status line.

### h

---

There are 253 rungs available in the standard circuit diagram, and another 253 in the safety circuit diagram, for wiring contacts and coils. The device reserves three rungs per circuit diagram for internal management purposes.

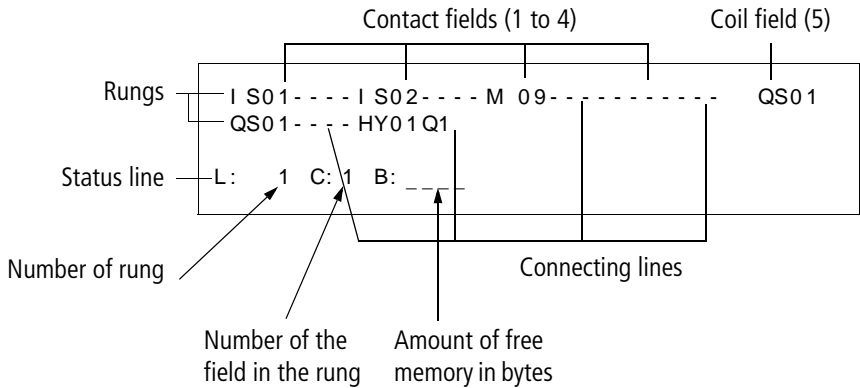

- **Connections** are used to produce the electrical contact between relay contacts and the coils. They can be created across several rungs. Each point of intersection is a connection.
- This indicates how much **memory** is still available for the circuit diagram and the function blocks. The number of free bytes is indicated.

### easySafety circuit diagram display

For greater legibility the circuit diagram of the easySafety device shows two contacts or one contact plus coil in a row on each rung. A total of 16 characters per circuit connection and three circuit connections plus the status line can be displayed simultaneously.

The cursor buttons can be used to change the contact fields. The number of the circuit connection and the contact are displayed in the lower status line.

## h

The circuit diagram display performs two functions:

- It is used to edit the circuit diagram in STOP mode.
- It is used in RUN mode to check the circuit diagram using the power flow display.

```
I S01 - - - - I S02 - -
QS01 - - - - HY01 Q1
L: 1 C: 1 B: 6010
```

---

**Transfer from and to the memory card**

Configurations are transferred via the serial multi-function interface. There are two possibilities:

- From or to a easySafety memory card, a page 124.
- Via the programming cable from or to the COM serial PC interface and thus from or to the configuration software easySoft-Safety, a page 129 or in the Online Help.

How to remove the cover of the serial multi-function interface, connect a programming cable and fit a memory card is described in section "Connecting the serial multi-function interface" on page 68.

**Information on the memory card**

The 256 KB memory card easySafety ES4A-MEM-CARD1 is available as an accessory for devices. This memory card can neither be read nor written by an easy800 or an MFD-Titan.

A configuration with all the necessary parameters can be loaded from the memory card into the easySafety device or written from the device to the card.

Each memory card stores a single easySafety configuration and two memory languages.

All information on the memory card is retained when the card is in a de-energized state, so that you can use the card for archiving, transporting and copying configurations.

On the memory card you can save:

- the configuration.
- all parameter sets of the configuration.
- all display texts with functions.
- the safety system settings:
  - Master and safety password.
  - Allow automatic overwriting from the card.
  - Sealing.
- the standard system settings:
  - P buttons.
  - Input delay (debounce).
  - Standard password and its areas.
  - Retention on/off and area.
  - easyNet configuration.
  - Daylight Saving Time settings.
- Second and third available menu languages (the information indicating which menu language is currently set is not stored).

### **Transfer from/to a device without display**

On devices without display and keypad ES4P-...-..XX, you can load the configuration easily from the PC with easySoft-Safety. Alternatively, the configuration can be loaded automatically from the memory card fitted every time the power supply is switched (see also section "Enabling overwriting from the card", page 581).

### Loading and saving with a memory card

The loading of a configuration from the memory card and the saving on the card is carried out via the CARD menu. The following overview shows how you operate with and without password.

h

The configuration is only transferred in STOP mode and when the power supply is switched on. If the power supply fails when the card is accessed, you must repeat the transfer as the data is possibly not fully transferred.

#### Main menu

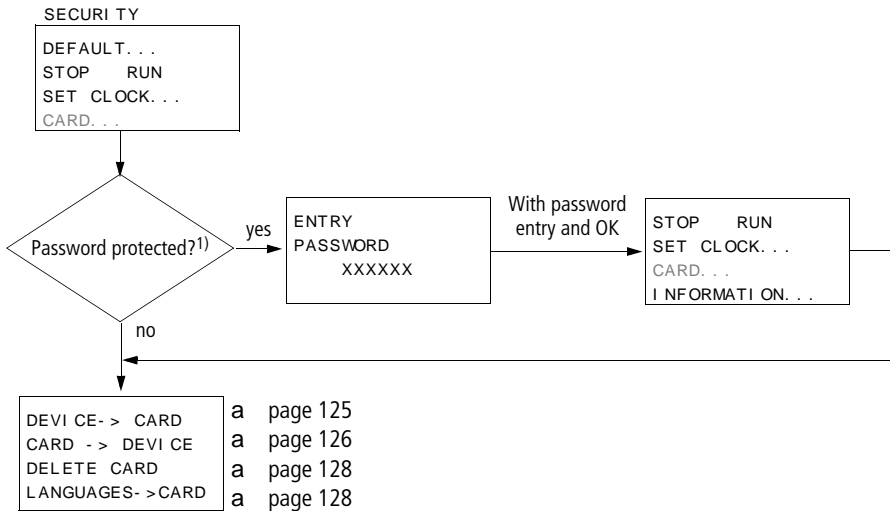

1) The CARD menu is marked with a minus character if it is protected with a standard password.

Figure 46: Choose CARD menu

X If necessary remove the memory card after the transfer and close the cover.



### Saving a configuration on the memory card (DEVICE -> CARD)

h

In devices without a display and keypad, transferring a configuration to the memory card is not possible.

Requirements:

- The device in the STOP.
- A memory card must be fitted in the device.
- You are in the CARD menu and password protection is removed, a figure 46 on page 124.

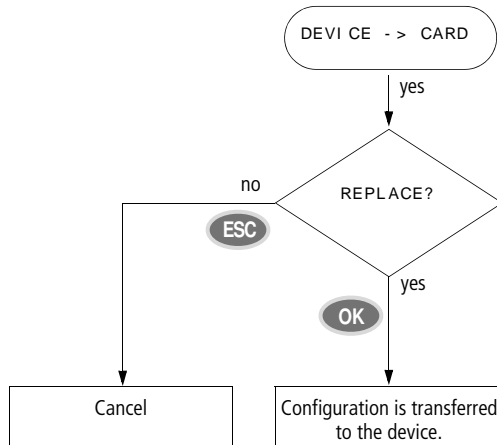

Figure 47: Save configuration on card

h

When transferring to the card, the password protected areas of the configuration are retained.

### Loading the configuration from the card (CARD -> DEVICE)

Requirements:

- The device in the STOP.
- A memory card is fitted in the device and has a configuration.
- You are in the CARD menu and password protection is removed, a figure 46 on page 124.

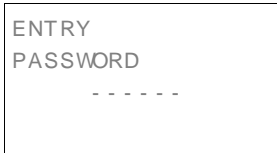

If a configuration with a safety circuit diagram is already in the device, this is protected separately. If the safety circuit diagram on the card is the same as the one in the device, only the standard circuit diagram is transferred. If however the safety circuit diagram in the device is different to the one on the card, you are requested to enter the system password before the safety circuit diagram in the device is overwritten.

**h**

All passwords that are present when saving to the card are also reactivated after the card is loaded.

- 1) Key to figure 48:  
The easySafety device stores a description of its inputs/outputs in the I/O profile. The current device version knows the following two I/O profiles
  - 14 IS, 4 QS (relay outputs) or
  - 14 IS, 4 QS (transistor outputs) and 1 QR (relay output). The configuration to be loaded on an easySafety must have the same I/O profile as the target device; otherwise the easySafety device will reject the transfer.
- 2) If there is a transfer problem or a check sum error, the easySafety device will output the message PROG INVALID.
- 3) Plausibility check that detects a faulty configuration of device version 02-xxx and refuses a transfer to the device.

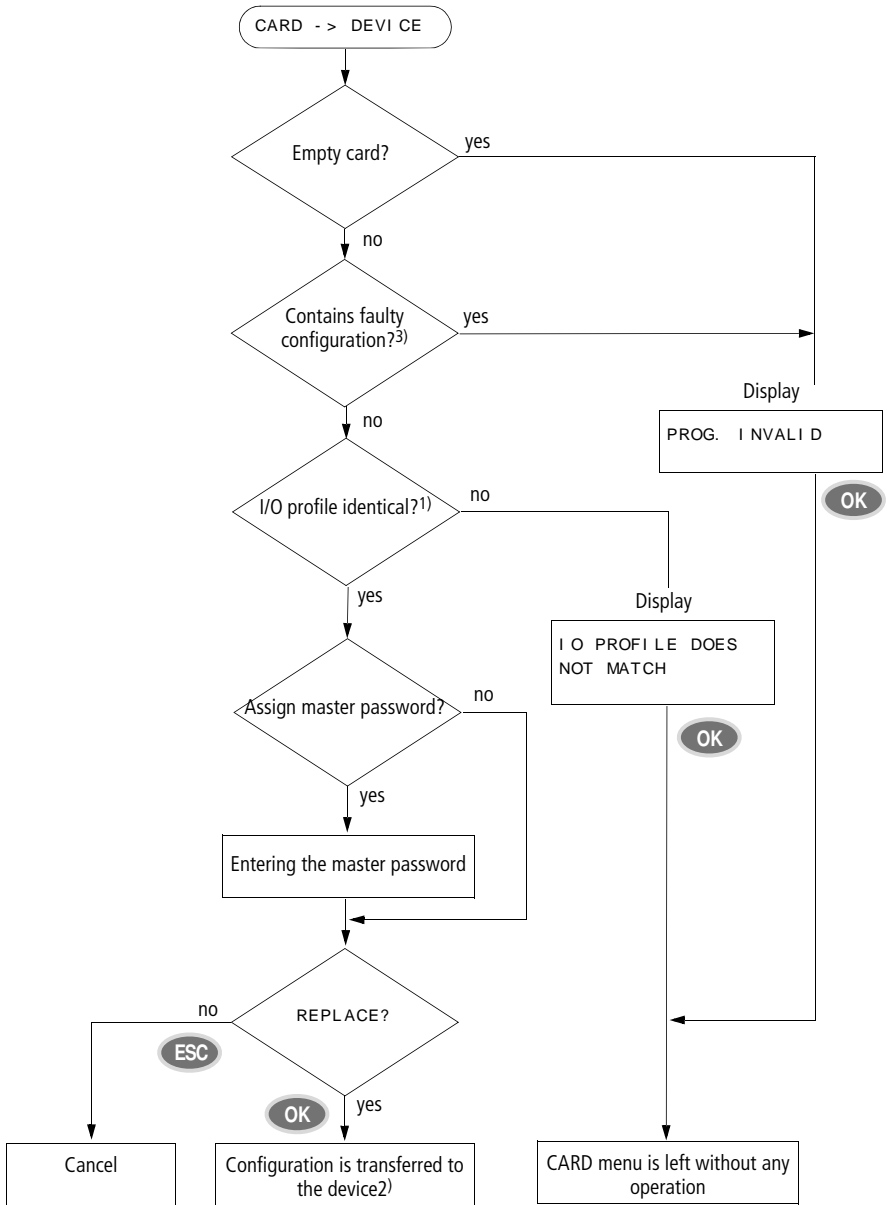

Figure 48: Load configuration from the card (key a page 126)

### Deleting a circuit diagram on the card

Requirement: You must be in the CARD menu.

DELETE ?

- X Select the DELETE CARD menu.
- X Confirm the safety prompt DELETE ? with OK if you wish to delete the card content.

Press ESC to cancel.

### Transferring the language from and to the memory card

CARD - > DEVI CE  
DELETE CARD  
LANGUAGES- >CARD  
CARD- >LANGUAGES

These two menu options can be used to transfer from and to the memory card two additional languages that you have transferred to the device in addition to the permanently installed menu language "English" from easySafety.

These variable menu languages can be stored together with the safety configuration on a card.

**Loading and saving with  
easySoft-Safety**

easySoft-Safety is a PC program with which you can do the following to a configuration:

- create it.
- test it in a simulation tool.
- document and manage it.
- write or read it to or from a connected and functional easySafety device.
- test it in RUN mode (Online) in the actual wiring.
- transfer a second or third menu language to the easySafety device.

h

Only use the programming cable provided in the original accessories for transferring data between the PC and the easySafety device (a section "Connection to a PC" on page 69).

h

**Caution!**

When connecting the programming cable, the easySoft-Safety programming software must be offline. On no account should the programming cable be replugged from one easySafety device to another when a connection has been established (online status).

h

A easySafety device cannot exchange data with the PC if it has been switched to the circuit diagram display.



Further information with detailed instructions on the easySoft-Safety configuration software is provided in the online help.

X Launch easySoft-Safety and then open the Help system by clicking ? or by pressing function key F1

Apart from the greater ease of operation, working with easySoft-Safety also provides a version control function. The safety configuration of the easySafety configuration is automatically assigned a version number. This is a four-digit number and starts with 0001 with every new project. Every

time a easySafety configuration is saved with a modified safety configuration easySoft-Safety increases the version number by 1.

h

In order to identify modifications to the safety configuration that were carried out on the device, the version number is always reset to 0000.

CONFIG. INVALID

If there is a transfer problem, the easySafety device shows the CONFIG. INVALID message.

X Check whether the device version in the configuration matches the easySafety device used or whether the memory card is not empty.

h

If the operating voltage fails during communication with the PC, repeat the last step. Not all data may have been transferred between the PC and easySafety device.

X After transmission, remove the cable and close the cover.

## Working with contacts and relays

Switches, pushbuttons and relays from a conventional hardwired circuit diagram are wired in the easySafety circuit diagram via input contacts and relay coils.

### easySafety safety circuit diagram

The following example of a safety circuit diagram is the emergency-stop circuit page 94 in section "The first circuit diagram". In the safety circuit diagram you wire from the input to the output, exactly like in the standard circuit diagram.

I S01-----	ES01 I 1
I S03-----	ES01 RE
ES01 QS-----	QS02
L: 1 C: 1 B: 5230	

Figure 49: Safety circuit diagram with inputs I S01, I S03, safety function block ES. . and output QS02

First specify which input and output terminals you wish to use in your circuit.

The signal states on the input terminals are detected in the circuit diagram with the input contacts I, R\* or RN. The outputs are switched in the circuit diagram with the output relays QS, QR or SN.

The jump destination has a special position for the input contacts and the jump location for the output relays. These are used for structuring a standard circuit diagram (a section "Jumps", page 150).

### Entering and changing contacts and coils

The following describes how you wire the different contacts and coils of different relay types or function blocks (inputs) in the circuit diagram.

#### Contacts

You choose an input contact in the easySafety device by means of the contact name and the contact number.

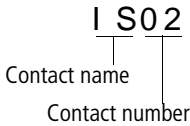

Example: Input contact

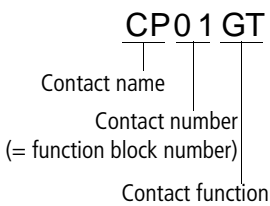

The contact of a standard function block consists of the abbreviated function block name, the number and the contact function.

Example: Contact of a standard comparator function block in the standard circuit diagram.

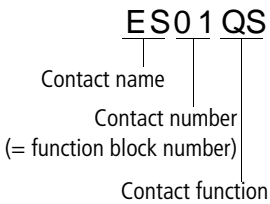

The contact of a safety function block consists of the abbreviated function block name, the number and the contact function.

Example: Contact of emergency-stop safety function block in the safety circuit diagram.

How a safety or standard function block is added as a contact or coil to the safety or standard circuit diagram and parameterised is described in section "Working with function blocks" on page 155.

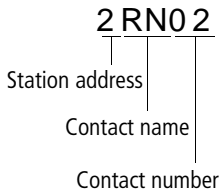

If the contact of an easyNet station is used in the standard circuit diagram, the NET ID (address) of the station is placed in front of the contact name, a section "Setting the NET ID of a NET operand", page 551.

Example: Contact of an easyNet station in the standard circuit diagram .



## Coils

With a relay coil or a function block, you choose the coil function, coil name, coil number as well as the function block coil. With coils of an easyNet station, choose the address (NET ID) in front of the coil name.

### h

The coil number in the figures on the left must be the same as the function block number!

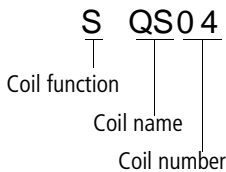

Example: output QS relay coil in the standard circuit diagram.

### j

## Danger!

Device outputs (QS., QR.) used in the standard circuit diagram are not safety outputs, and may only be used for standard tasks. Make sure that these outputs do not trigger any safety-related actions on the machine or plant.

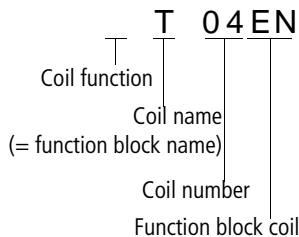

Example: relay coil for timing relay standard function block with control coil in the standard circuit diagram.

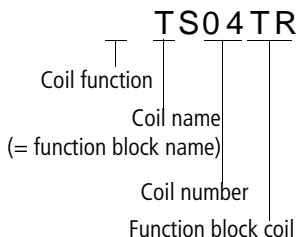

Example: relay coil for safety timing relay safety function block with control coil in the safety circuit diagram.

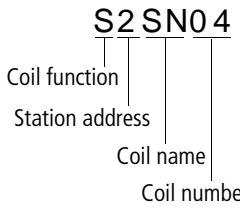

Example: Relay coil of an easyNet station in the standard circuit diagram.

h

A complete list of all contacts and coils is provided in the Appendix on page 643.

I S01

Values for contacts and coil fields are changed in Entry mode. The value to be changed flashes.

h

The easySafety device proposes contact I S01 or the coil QR01 for entry in an empty field.

- X Use **←** to move the cursor to a contact or coil field.
- X Press OK to switch to Entry mode.
- X Use **→** to select the position you wish to change or move to the next position with OK.
- X Use **↵** to modify the value of the position.

The easySafety device closes entry mode as soon as you leave a contact or coil field with **←** or OK.

In the contact field  
change I s01 to I s02

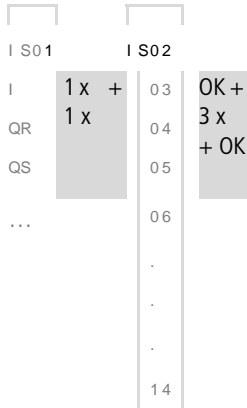

OK

In the coil field  
change QR01 to S QS04

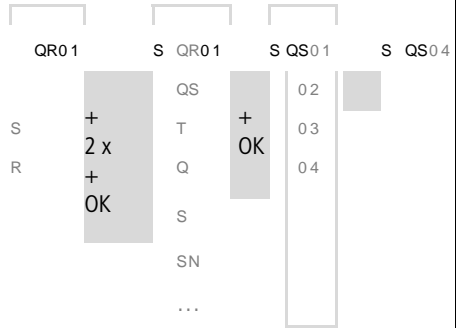

OK

### Deleting contacts and coils

- X Use **←** to move the cursor to a contact or coil field.
- X Press **DEL**.

The contact or the coil will be deleted, together with any connections.

### Changing make contacts to break contacts

You can define each contact in the circuit diagram as a make or break contact.

- X Switch to Entry mode and move the cursor over the contact name.
- X Press **ALT**. The make contact will change to a break contact.
- X Press **OK** twice to confirm the change.

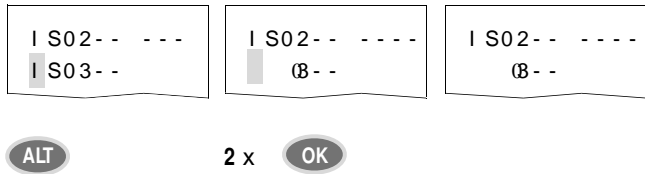



Figure 50: Changing contact I s03 from make to break

### Creating or changing connections



Contacts and relay coils are connected with the wiring arrow in Connect mode. The easySafety device displays the cursor in this mode as a wiring arrow.

X Use  to move the cursor to the contact or coil field from which you wish to create a connection.

h

Do not position the cursor on the first contact field. Here the ALT button has a different function (add rung).

X Press ALT to switch to Connect mode.

X Use  to move the arrow between the contact and coil fields and use  to move between the rungs.

X Press ALT to leave Connect mode.

The easySafety device closes the mode automatically as soon as you have moved the arrow to an occupied contact or coil field.

h

In a rung, the easySafety device connects contacts and the connection to the relay coil automatically if no empty fields are between them.

Never work backwards. You will learn why wiring backwards does not work in section "How the easySafety device evaluates the safety and standard circuit diagram as well as the function blocks", page 604.

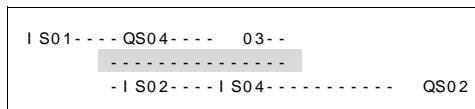

Figure 51: Circuit diagram with five contacts, invalid

With more than four contacts in series, use one of the 32 MS safety markers or in the standard circuit diagram one of the 96 M markers.

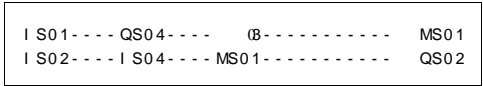

Figure 52: Circuit diagram with MS marker

**Deleting connections**

- X Move the cursor onto the contact field or coil field to the right of the connection that you want to delete. Press ALT to switch to Connect mode.
- X Press DEL.

The easySafety device deletes a connection branch. Closed adjacent connections will be retained.

Close the delete operation with ALT or by moving the cursor to a contact or coil field.

### Adding or deleting rungs

The circuit diagram display shows three of the 256 rungs at the same time. Rungs outside of the display, including empty rungs, are scrolled by easySafety automatically in the circuit diagram display if you move the cursor beyond the top or bottom of the display.

A new rung is added below the last connection or inserted above the cursor position:

- X Position the cursor on the **first** contact field of a rung.
- X Press ALT.

The existing rung with all its additional connections is "shifted" downwards. The cursor is then positioned directly in the new rung.



Figure 53: Inserting a new rung

### Saving circuit diagrams

- X Press **ESC** to save a circuit diagram.

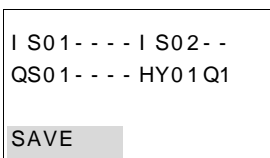

The menu on the left appears in the status line.

- X Press **OK** to store the configuration and the function blocks.

After saving, you will be returned to the previous menu from which you have opened the circuit diagram.

### Aborting circuit diagram entry

```
I S01 - - - - I S02 - -
QS01 - - - - HY01 Q1
CANCEL
```

- X Press ESC to leave the circuit diagram entry without saving.
- X Use the cursor buttons to select the CANCEL menu.
- X Press OK.

The circuit diagram is closed without saving.

### Searching for contacts and coils

```
I S01 - - - - I S02 - -
QS01 - - - - HY01 Q1
SEARCH
```

- Boolean operands or function blocks that are wired as contacts or coils can be found in the following way:
- X Press ESC. Use the cursor buttons to enter the SEARCH menu.
  - X Press OK.

```
I S01 - - - - I S02 - -
QS01 - - - - HY01 Q1
SEARCH I S01
```

- X Use the cursor buttons and to select a contact or coil as well as the required number.
- For a function block you select the function block name and the number.
- X Confirm the search with the OK button.

```
I S01 - - - - I S02 - -
QS01 - - - - HY01 Q1
L: 1 C: 1 B: 7140
```

The search starts at the point where the search is activated, continues to the end of the circuit diagram, and, if necessary, from the start of the circuit diagram if the required contact or the coil is not found. If the search is successful, you will automatically reach the required contact or coil field in the circuit diagram.



### Got to a rung

The GO TO function can be used to go to a different rung.

- X Press ESC and use cursor buttons to select the GO TO menu.
- X Press OK.
- X Select the required rung (L...) with the cursor buttons.

```
I S01 - - - - I S02 - -
QS01 - - - - HY01 Q1
```

```
L: 1 C: 1 B: 7140
```

Always the first contact of the rung is displayed.

- X Press **OK**.

```
I S01 - - - - I S02 - -
QS01 - - - - HY01 Q1
```

```
L: 1 C: 1 B: 7140
```

The cursor stops at the first contact L 1 of the required rung.

**h**

You can use the "GO TO" function to jump to any rung, up to the last wired rung.

### Deleting rungs

The easySafety device only removes empty rungs (without contacts or coils).

- X Delete all contacts and coils from the rung.
- X Position the cursor on the first contact field of the empty rung.
- X Press DEL.

The subsequent rung(s) will be "pulled up" and any existing links between rungs will be retained.

### Switching with the cursor buttons

The easySafety device allows the four cursor buttons also to be used as permanently wired inputs in the standard circuit diagram.

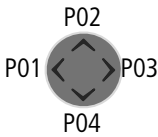

The buttons are wired in the standard circuit diagram as contacts P 0 1 to P 0 4 . The P buttons can be activated and deactivated in the h STD-PARAMETER h System menu.

The P buttons can be used for testing standard circuits or for manual operation. The P button function is a useful aid for service and commissioning tasks.

#### Example 1

This standard circuit diagram example enables a lamp at output QS1 to either be switched on or off via the inputs IS1 and IS2 or via the cursor buttons .

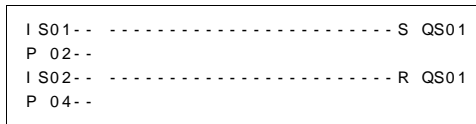

Figure 54: Switch QS1 via IS1, IS2, , or

#### Example 2

In this example of a standard circuit diagram output QS1 is actuated through input IS1. Input IS5 switches to cursor operation and decouples current path I S01 through 01 .

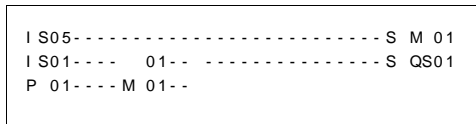

Figure 55: IS5 switches to cursor buttons.

h

The easySafety device only evaluates P button entries if the status display is shown.

The display in the status menu shows whether the P buttons are used in the standard circuit diagram.



```
I S02== =====S QS04  
I S03==  
  
L: 001 C: 1 RUN
```

Figure 57: Power flow display

In the power flow display, energized connections are thicker than non-energized connections.

You can follow energized connections across all rungs by scrolling the display up and down.

The power flow display indicates at the bottom right the controller is in RUN mode. (see also „Power flow display with Zoom function“, page 106).

**h** The power flow display does not show signal changes in the millisecond range due to the inherent technical delay of LCD displays.

## Coil functions

You can set the coil function to determine the switching behaviour of relay coils. The following coil functions are assigned to all coils:

Table 10: Coil function

easySafety display	Coil function	Example	a Page
	Contactor function	QS01, D02, S04, :01, M07,...	146
	Impulse relay function	QS03, M04, D08, S07, :01,...	146
S	Set	SQ08, SM02, SD03, SS04...	147
R	Reset	RQ04, RM05, RD07, RS03...	147
	Contactor function with negated result	QS04, M96...	148
	Cycle pulse with rising edge	M01...	148
	Cycle pulse on falling edge	M42...	149

h

The function block coil functions that can be used are described with the function blocks.

h

With non-retentive coil functions such as (contactor), (negated contactor), , (rising and falling edge evaluation): Each coil must only be used once. The last coil in the circuit diagram determines the state of the relay. Exception: When working with jumps, the same coil can be used twice.

Retentive coil functions such as S, R, can be used several times.

### Coil with contactor function

The output signal follows immediately after the input signal and the relay acts as a contactor.

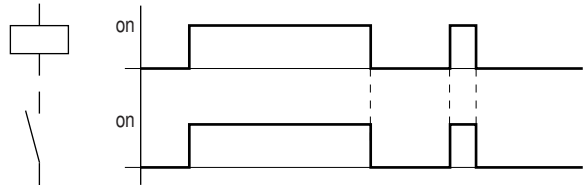

Figure 58: Contactor function signal diagram

### Impulse relay

The relay coil switches whenever the input signal changes from 0 to 1. The relay behaves like a bistable flip-flop.

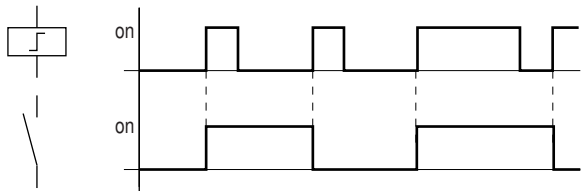

Figure 59: Impulse relay signal diagram

A coil is automatically switched off in the event of a power failure and in STOP mode. Exception: Retentive coils retain signal 1 (a section "Retention", page 597).

**Set S and Reset R coil function**

The Set S and Reset R coil functions are normally used in pairs.

The relay picks up when the coil is set (A) and remains in this state until it is reset (B) by the coil function.

The supply voltage is switched off (C), the coil does not have a retentive effect.

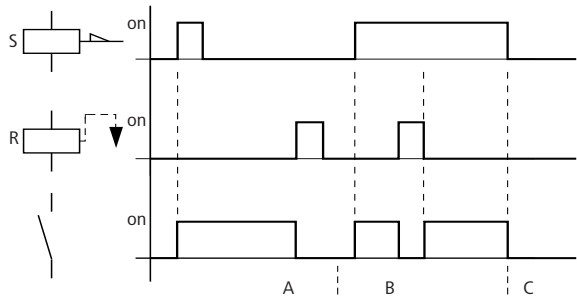

Figure 60: Set and Reset signal diagram

If both coils are triggered at the same time, priority is given to the coil in the circuit diagram with the higher circuit connection number. This is shown in the above signal diagram in section B.

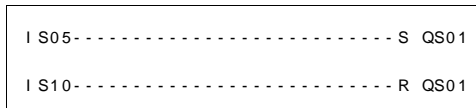

Figure 61: Simultaneous triggering of QS01

In the example above, the reset coil has priority with simultaneous triggering of the set and reset coils.

**Coil negation (inverse contactor function)**

The output signal follows the inverted input signal, the relay works like a contactor with negated contacts. If the coil is set to 1, the coil will switch its make contacts to 0.

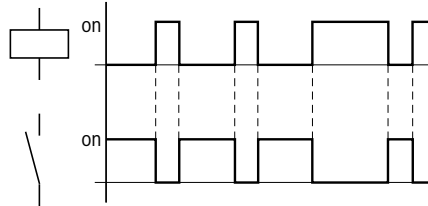

Figure 62: Inverse contactor function signal diagram

**Rising edge evaluation (cycle pulse)**

This function is used if the coil is only meant to switch on a rising edge. When the coil status changes from 0 to 1, the coil switches its make contacts to 1 for one cycle.

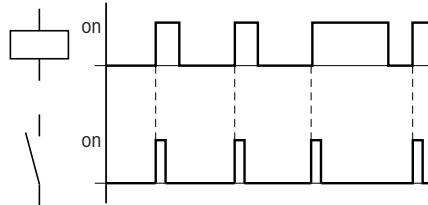

Figure 63: Signal diagram of cycle pulse with rising edge



**Falling edge evaluation (cycle pulse)**

This function is used if the coil is only meant to switch on a falling edge. When the coil status drops out from 1 to 0, the coil switches its make contacts to 1 for one cycle.

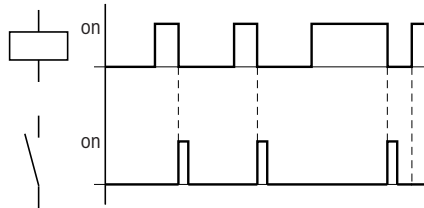

Figure 64: Signal diagram of cycle pulse with negative edge

**h**

A set coil is automatically switched off in the event of a power failure and in STOP mode. Exception: Retentive coils retain signal 1 (a section "Retention", page 597).

### Jumps

Jumps ... can be used for structuring a standard circuit diagram.

They replace the function of a selector switch. Jumps can be used, for example, to implement the selection of manual/automatic mode or various machine programs.

Jumps ... consist of a jump location and a jump destination (label) and are only used in the standard **circuit diagram**.

Details on the use of jumps in the standard **function block diagram** are provided in section "LB, jump label" on page 272 and in section "JC, conditional jump" on page 268.

The easySafety device allows the use of up to 16 jumps.

### Circuit diagram symbols for jumps

Contact	
N/O contact <sup>1)</sup>	:
Numbers	01 up to 16
Coils	
Numbers	01 up to 16
Coil function	, , , ,

1) Can only be used as first contact on the left

**Function**

If the jump coil is triggered, the rungs after the jump coil are no longer processed. The states of the coils before the jump will be retained, unless they are overwritten in rungs that were not missed by the jump. Jumps are always made forwards, i.e. the jump ends on the first contact with the same number as that of the coil.

- Coil = jump on 1 state
- Contact only at the first leftmost contact = Jump label

The jump contact location is **always 1**.

h

Backward jumps cannot be executed due to the way in which easySafety works. If the jump label does not come after the jump coil, the jump will be made to the end of the circuit diagram. The last rung is also skipped.

The same jump coil and contact can be used several times as long as they are used in pairs, i.e.:

Coil :1/skipped area/contact:1,

Coil :1/skipped area/contact:1

etc.

h

**Caution!**

If rungs are skipped, the states of the coils are retained. The time of started timing relays continues to run.

**Power flow display**

Jumped sections are indicated by the coils in the power flow display.

All coils after the jump coil are shown with the symbol of the jump coil.

**Example**

A selector switch is used to select two different sequences.

- Sequence 1: Switch on motor 1 immediately.
- Sequence 2: Activate barrier 2, wait time, then switch on motor 1.

Contacts and relays used:

- I S1 Sequence 1
- I S2 Sequence 2
- I S3 Barrier 2 moved out
- I S12 Motor-protective circuit-breaker switched on
- QS1 Motor 1
- QS2 Barrier 2
- T01 wait time 30.00 s, on-time
- D 01 Text "Motor-protective circuit-breaker tripped"

Circuit diagram:

Power flow display: I 01 selected:

I S01-----	: 01
I S02-----	: 02
: 01	
-----	QS01
- RQS02	
-----	: 08
: 02-----	QS02
QS02- I S03- T T02	
T 02-----	QS01
: 08	
12-----	D01

I S01=====	: 01
I S02-----	: 01
: 01	
=====	QS01
	RQS02
=====	: 08
: 02=====	08
QS02- - I S03- -	: 08
T 02-----	: 08
: 08	
12-----	D01

Range from jump label 1 processed.

Jump to label 8.

Range to jump label 8 skipped.

Jump label 8, circuit diagram processed from this point on.

## Test outputs, test signals

easySafety is provided with 4 outputs with test signals T1 to T4 for detecting cross-circuits at the device inputs or in the external wiring.

In the following example, the emergency-stop switch S1 is connected to test outputs T3 and T4. When the emergency-stop is not triggered, their test signals reach the device inputs IS9 and IS10. The device monitors the presence of the uninterrupted test signals at the device inputs. In the event of a cross-circuit of signals T3 and T4, this is detected by the device.

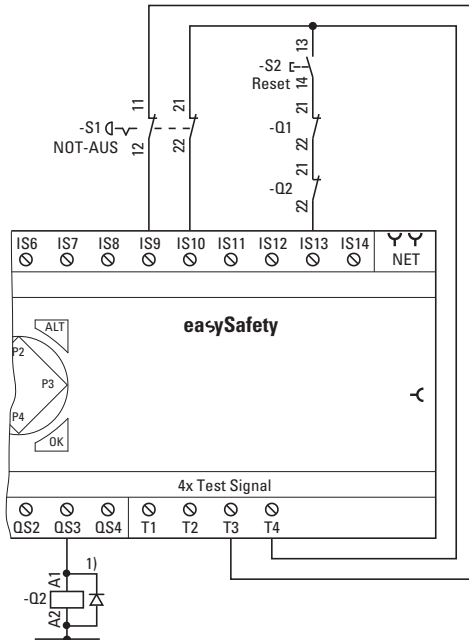

Figure 65: Using test signals  
 1) Use free-wheel diode suppressors for ES4P-221-DMX.. devices with device version 02 and 10

You can configure as required the test outputs you wish to use for a particular input.

h

When using a test output for several inputs ensure that no hazardous faults can occur.

SECURITY...  
DEFAULT...  
STOP RUN  
SET CLOCK...

To do this press OK to open the main menu and enter SECURITY...

S- PROGRAM...  
SAFETY TEST  
TEST SIGNALS...

an also via TEST SIGNALS...

I S01 <- -  
I S02 <- -  
I S03 <- -  
I S04 <- -  
I S05 <- -  
I S06 <- -  
I S07 <- -  
I S08 <- -  
I S09 <- T3  
I S10 <- T4\*  
I S11 <- -  
I S12 <- -  
I S13 <- T4\*  
I S14 <- -

to the test signal assignment.

This is where you use the cursor buttons and OK to assign the test signals to device inputs.

The example shown illustrates the assignment of the different test signals:

- T3 is only assigned to input IS09.
- T4 is assigned to inputs IS10 and IS13, indicated by the \* behind it.

## Working with function blocks

This chapter describes further on how to add and parameterise function blocks in the circuit diagram. A detailed description of all available function blocks is provided in the sections „Standard function blocks“ on page 173 and „Safety function blocks“ on page 341. The function blocks are presented there in alphabetical order. This section, however, describes some general notes on working with function blocks.

Function blocks allow you to emulate different devices in your circuit diagram from conventional safety, open-loop and closed-loop control technology. Function blocks for easySafety devices are divided into:

- safety function blocks for implementing safety functions.
- standard function blocks for normal open-loop and closed-loop control tasks.

The following applies to function blocks:

h

Current actual values are deleted when you switch off the power supply or switch easySafety to STOP mode. Exception: retentive data keeps its state (a section "Retention", page 597).

The most recent actual values are transferred to the operands every cycle. The data function block is an exception.

h

If you do not wish to enable others to modify the standard function blocks, set the enable character from "+" to "-" when entering the circuit diagram and entering the parameters, and protect it with a standard password. The parameters of the safety function blocks are automatically protected by the master password.

h

As every standard function block in the function block list takes up memory, even if it is no longer being used and has been deleted in the standard circuit diagram, you should clear it occasionally.

Check the standard function block diagram for any function blocks that are no longer required and delete them, a section "Deleting function blocks", page 170.

h

**Caution!**

RUN mode: easySafety processes the function blocks after the circuit diagram has been run through. This takes the last status of the coils into account.

h

The function blocks are designed so that an output value of a function block can be assigned directly with an input of another function block. The 32-bit data format is used automatically. This also enables the transfer of negative values.



### Adding function blocks to the circuit diagram for the first time

You can add a standard or safety function block to the standard or safety circuit diagram in the following way:

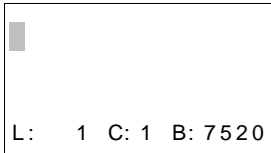

X Use the  buttons to move the cursor to a free contact or coil field.

X Press OK so that the easySafety device switches to entry mode.

When editing the safety circuit diagram you have to enter the M password before this change if the device has not been unlocked (a  page 571).

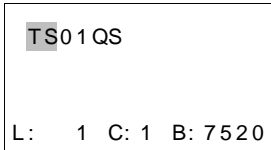

X Then use cursor buttons  to select the required function block, e.g. safety timing relay using the TS identifier.

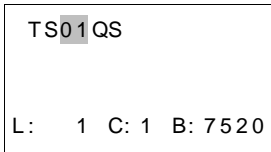

X When the function block identifier flashes, press OK or the cursor button  to move to the function block number and press OK.

The parameter dialog opens. In this dialog you can assign all the parameters for a safety function block. You can only set Boolean parameters here for the standard function blocks. The entire parameterisation is carried out in the function block editor. Further information on this is provided in the following chapter.

### Setting function block parameters

Safety function blocks with which you can implement your safety functions are always part of the safety circuit diagram. Unlike standard function blocks, the parameters are set from the safety circuit diagram instead of in a special function block editor.

Standard function blocks are simply called in the standard circuit diagram and also enter the basic parameters there. You assign actual value and setpoint parameters for the function block inputs and outputs via the FUNCTION RELAYS menu. You can of course also set the basic parameters in the function block editor and then add the standard function block in the standard circuit diagram as a contact or coil.

The edited standard function blocks are always part of the standard circuit diagram.

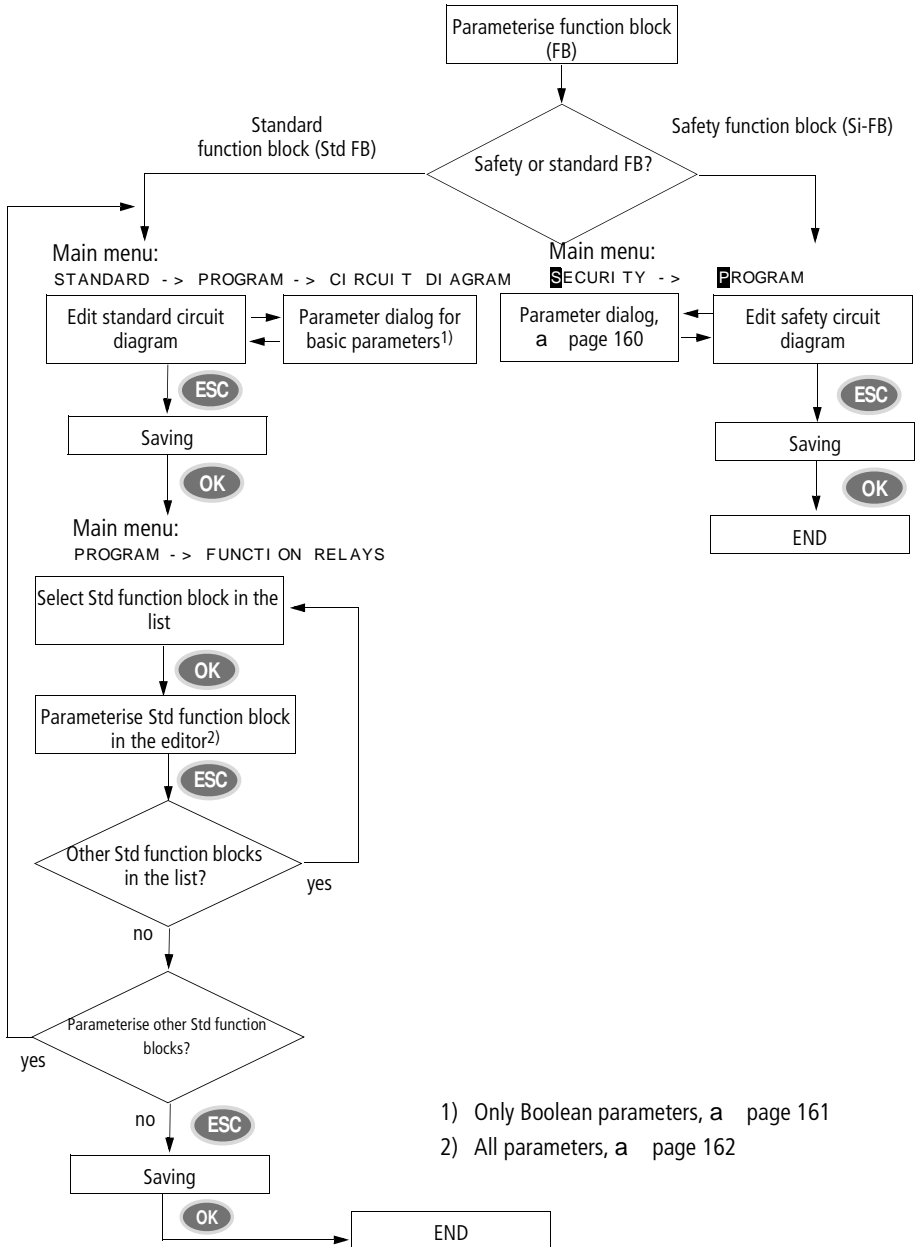

1) Only Boolean parameters, a page 161

2) All parameters, a page 162

Figure 66: Overview of function block parameter assignment

### Parameter assignment from the safety circuit diagram

The parameter dialog for the safety function block is opened.

TS01	S	X	*
	***	***	
>T1	000.	000	
>T2	000.	000	

The figure on the left shows a parameter dialog with the example of the safety function block TS, Safety timing relay.

X Use the cursor buttons to select the parameter to be changed, for example the time range.

X Use the cursor buttons to change the parameter value to a different time range such as M:S.

X Use cursor button or OK to change to the first time set value T1.

X Press OK to enter the Entry mode and then press cursor button until you have reached the digit to be entered.

X Use the cursor buttons to set the constant value and confirm with OK.

X Use cursor button to enter the value of the second setpoint entry and enter this in the same way.

X Use ESC to close the parameter dialog.

The values are now stored.

X Complete the safety circuit diagram.

If you add the same function block in a different contact or coil field once more to the safety circuit diagram and the parameter dialog opens with the parameters already assigned, you just have to press ESC to return to the previous position without having to change parameters. Refer to „Changing function block parameters“ on page 166 for how to change a parameter value or operand.

### Parameter assignment from the standard circuit diagram

When a standard function block is added for the first time, the parameter dialog is started automatically.

```
T 01 X? S +
>I 1
>I 2
QV>
```

The figure on the left shows a parameter dialog with the example of the standard function block TS, Safety timing relay. The parameter options depend on the standard function block concerned. They cover the basic parameters of the first line up to the +/- character. Through the +/- symbol you can switch the parameter display on and off in operating mode RUN to allow (+) or prevent (-) changes to be made to reference points (constants). You must at least confirm the +/- character with OK.

### h

Parameter sets can only be enabled or protected via the FUNCTION RELAYS menu, or via the circuit diagram with the "+" enable and with "-" inhibit parameter set characters.

- X Use the cursor buttons to select the parameter to be changed, for example the time range "S".
- X Use the cursor buttons to change the parameter value to a different time range such as M:S.
- X Press OK to exit the parameter dialog if you wish to save the parameters or press ESC, if you do not wish to parameterise the function block and add it to the circuit diagram.

After saving or cancelling, the cursor returns to the position in the standard circuit diagram where you last left it.

To complete the parameter setting of the standard function block, such as the setting of setpoints, call up the function block editor in the following way:

- X Press **ESC** in order to save the circuit diagram with the newly added standard function block.
- X Answer the subsequent SAVE prompt with OK.

The standard circuit diagram is saved and the easySafety device changes to the next higher menu level.

### Parameter setting in the function block editor (standard function blocks)

Open the function block editor via the FUNCTION RELAYS menu. Then first enter the function block list in which the standard function blocks used are listed.

If no standard function blocks are shown, the list is empty.

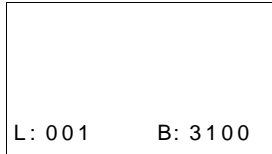

In our example, the list contains the function blocks AR, CP and T. The function blocks are created in the order in which they were edited.

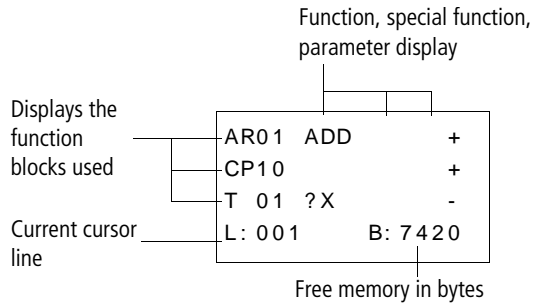

Figure 67: Explanation of the function block list

AR01	ADD	+
CP10		+
T	01 ?X	-
L: 001	B: 7420	

X Use the cursor buttons to select the required standard function block from the function block list, in this case timing relay T01.

The timing relay is shown in the function block editor and can be fully assigned parameters here.

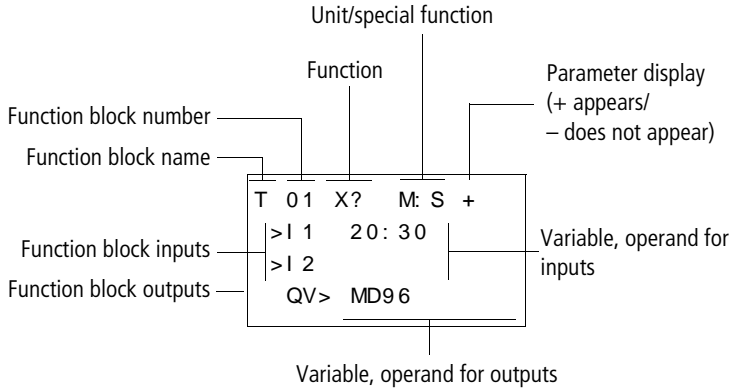

Figure 68: Display of the standard function blocks in the function block editor

```

T 01 X? M: S +
>I 1 20: 30
>I 2
QV> MD96
    
```

Example: standard timing relay function block

Function block:	Timing relay
Switch function:	On-delayed with random time
Time range:	M:S (Minute:Second)
Set time >I1:	20 min 30 s
Actual time QV>:	Copied to MD96

### Assigning operands at the input of a standard function block

The following operands can be assigned to the input of a standard function block:

- Constants, e.g.: 42,
- Markers such as MD, MW, MB,
- All output variables of the function blocks ...QV>

## h

### Caution!

When assigning the parameters of a standard function block input, ensure that these cannot be triggered with impermissible values during operation. There is a danger of this if you assign a variable that can assume negative values to a standard function block input that can only accept positive values.

If, for example, the standard function block T timing relay is triggered with a negative time set value, it will no longer switch in the expected way.

You should therefore take care to exclude such situations, as the easySafety device cannot foresee these when the parameters are assigned.

If, for example, you have assigned the QV output of the AR arithmetic function at input I1 of the T standard function block, you should add the CP comparator in between in order to detect and indicate the occurrence a negative value.

In most applications, a thorough simulation is enough to prevent any impermissible values at the function block input.



### Assigning operands at the output of a safety function block

The actual value ...QV of a safety function block is normally used to output the actual values of monitoring times or frequencies.

You can assign the ...QV actual value output of a safety function block to the MD, MW, MB markers or to the input of certain standard function blocks in the standard function block diagram. The assignment to a standard function block input, e.g. to the I1 input of a DB data function block, is made when defining the parameters for this input (I1 in the example).

### Deleting operands at standard function block inputs/outputs

Position the cursor on the required operand.

X Press the DEL button.

```
T 01 ?X M: S +
>I 1      : 30
>I 2
  QV> MD96
```

The operand is deleted.

```
T 01 ?X M: S +
>I 1
>I 2
  QV> MD96
L: 001      B: 4312
```

### Changing function block parameters

A easySafety device allows you to change the parameters of standard function blocks, such as the setpoints of timing or counter relays without calling up the circuit diagram. To change these parameters, the easySafety device must be in RUN mode.

With safety function blocks, parameters can only be changed via the safety circuit diagram and only then if the easySafety device is in STOP mode. The procedures for changing parameters of a safety or standard function block are different:

#### Changing safety function block parameters

Requirement: The easySafety device must be in STOP mode!

Proceed as follows to call the parameter dialog again for changes:

- X Select the safety function block in the safety circuit diagram.
- X Press OK to enter Entry mode.
- X Move to the function block number and press OK.  
The parameter dialog opens.
- X Press OK or cursor button to move to the parameter to be changed.
- X Change the parameters required, e.g. the time range M:S (Minute:Second) to S (Second) and exit the parameter dialog with ESC.

The easySafety device returns to the safety circuit diagram.

### Changing standard function block parameters

Parameters of the standard function blocks that you use in the standard circuit diagram can be changed with the following accesses:

- Access 1 - FUNCTION RELAYS, STOP mode  
All parameters can be set or deleted via STANDARD -> PROGRAM -> FUNCTION RELAYS and the function block editor.
- Access 2- FUNCTION RELAYS menu, RUN mode  
You access the function block editor via STANDARD -> PROGRAM... -> FUNCTION RELAYS. Here you can change set values (constants). This access is blocked on a password-protected program.
- Access 3- PARAMETERS menu option, RUN mode  
Choose STANDARD -> PARAMETERS to change the set values (constants). These modification options are also provided if you have saved the program and therefore password protected the function block editor. With the standard function blocks uses you can use the +/- character to set which function blocks allow the changing of their parameters.

#### Access 1 - FUNCTION RELAYS, STOP mode

This access method is basically no different to the initial parameter assignment of a standard function block (a section "Parameter assignment from the standard circuit diagram", page 161).

#### Access 2 - FUNCTION RELAYS, RUN mode

Requirements for the parameter setting via STANDARD ->FUNCTION RELAYS:

- The standard function block is used in the standard circuit diagram or function block.
- Access to the parameter set is enabled, indicated by the +/- character at the top right of the display.

Proceed as follows to call the parameter dialog again for changes:

X Press OK to switch to the main menu.

X Open the function block list via STANDARD -> PROGRAM  
-> FUNCTION RELAYS.

First enter the function block list. All standard function blocks used in the standard circuit diagram are displayed here.

T	03	S	+
CP	08		-
C	17		+
L:	1	RUN	

X Use or to select the required standard function block.

X Press OK.

X Scroll with the or cursor buttons through the constants of the function block inputs.

X Change the values for a parameter set:

- OK: Switch to Entry mode.
- Change decimal place.
- Change value at a decimal place.
- OK: Save constant immediately and exit the parameter display by pressing ESC.

ESC: Keep the previous setting and exit the parameter display.

**h**

It is only possible to change input values at standard function blocks if they are setpoints (constants).

**Access 3- PARAMETERS menu, RUN mode**

Requirements for parameter assignment via STANDARD ->PARAMETERS:

- The easySafety device is in RUN mode.
- The standard function block is used in the standard circuit diagram or function block.
- Access to the parameter set is enabled, indicated by the +/- character at the top right of the display.

Proceed as follows to call the parameter dialog again for changes:

- x Press OK to switch to the main menu.
- x Open the function block list via STANDARD -> PARAMETERS.

T	03	S	+
CP08			-
C	17		+
L:	1	RUN	

All standard function blocks used in the standard circuit diagram are displayed in the function block list.

Proceed from here as previously described in section "Access 2 - FUNCTION RELAYS, RUN mode".

### Deleting function blocks

Requirement: The easySafety device must be in STOP mode.

X Move the cursor in the circuit diagram to all the contact fields and the coil field in which the function block to be deleted is used and press DEL each time. In the following example, delete first of all contact field ES0111, then contact field ES01RE and finally coil field ES01QS. The grey fields shows the currently flashing cursor position.

I S07-----	ES011 1
I S08-----	ES01RE
ES01QS-----	QS02
L: 1 C: 1 B: 7704	

Figure 69: Deleting the safety function block ES

### Deleting standard function blocks from the function block list

In order to prevent accidental deletion, a standard function block continues to be managed in the function block list, even if it was already removed in the standard circuit diagram. To delete the standard function block permanently and therefore to free up more memory, you must remove it from the function block list.

AR01	ADD	+
CP10		+
T 18	?X	-
L: 002	B: 5430	

X Open the function block list via STANDARD -> PROGRAM -> FUNCTION RELAYS.

X Select the standard function block to be deleted in the function block list, in this case CP10.

X Press the DEL button.

The standard function block is removed from the function block list.

X Press ESC in order to save the function block with the deleted standard function block.

X Answer the subsequent SAVE prompt with OK.

### Checking function blocks

Requirement for the check: The easySafety device must be in RUN mode.

### Checking safety function blocks

You can check safety function blocks using the safety circuit diagram.

- X In the circuit diagram, position the cursor on the required safety function block in a contact or coil field.
- X Press OK.

TS01	S	X	*
	***	***	
>T1	022,000		
>T2	011,000		

The function block is shown, in this case a safety timing relay.

- >T1= time value 1, set time 1 of the safety timing relay.
- >T2= time value 2, set time 2 of the safety timing relay.

- X Press ESC to return to the display of the safety circuit diagram.
- X To leave the check display, press ESC once more and press OK in answer to the subsequent CANCEL prompt.

### Checking standard function blocks

You can check standard function blocks via the function block editor.

Choose STANDARD -> PROGRAM... -> FUNCTION RELAYS to enter the function block list which shows the standard function blocks used.

- X In the function block list select the required standard function block.

AR01	ADD	+
CP10		+
T 18	?X	-
L: 001	RUN	

In this example, select the data block comparator AR01 in Adder mode.

- X Press OK.

```
AR01  ADD      +
>I 1   20056
>I 2   1095
QV>  21151
```

Depending on the display selected the standard function block is shown with the actual values and the result, or with the set operands and constants.

Press the ALT button if you wish to switch from operand to actual value display or vice versa during the check of the standard function block.

```
AR01  ADD      +
>I 1   C 01QV>
>I 2   1095
QV>  MD 56
```

The operand is displayed.

- >I1= Actual value, here from the output of the counter C 01
- >I2= Constant 1095.
- QV> = Marker double word MD56

X Press the ALT button again (see also the following note).

```
AR01  ADD      +
>I 1   20056
>I 2   1095
QV>  21151
```

The display changes again to the display of actual values and the result.

## h

Press ALT to switch likewise to the display of the standard function blocks as well as the other contact and coil operands in the standard circuit diagram. You can use ALT to switch from full but only partial display to a compact display showing all contacts and coils on one circuit diagram line. Pressing ALT once more will switch you back to the original display.

X Press ESC to return to the function block list.

X To leave the check display, press ESC once more and press OK in answer to the subsequent CANCEL prompt.



## 5 Standard function blocks

Standard function blocks are used to implement NON-safety-related tasks in the controller. They are therefore only used in the standard circuit diagram.

**j**

### **Danger!**

Device outputs QR and QS that are set by the standard circuit diagram are not safety outputs and must only be used for standard tasks. Ensure that these outputs do not trigger safety-related functions on the machine or plant.

**A, analog value comparator/threshold value switch**

An analog value comparator or threshold value switch is used, for example, to compare marker contents and switch when defined threshold values are reached.

easySafety allows the use of up to 16 analog value comparators/threshold switches.

**Function block**

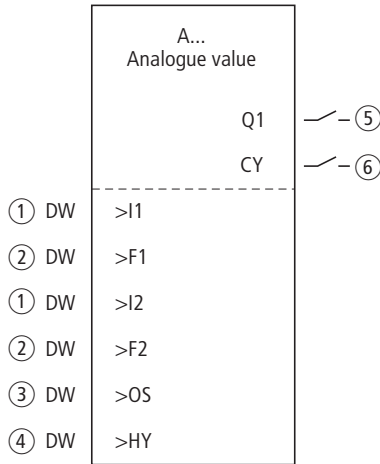

Figure 70: Analog value comparator function block

- ① Inputs A..I1 and A..I2: The comparison value 1 at input >I1 is compared with the comparison value 2 at >I2.
- ② Inputs A..F1 and A..F2: Values entered here are used as multiplication factors to adjust the comparison values 1 and 2.
- ③ Input A..OS: Offset for comparison value 1.
- ④ Input A..HY: Positive and negative hysteresis for comparison value 2.
- ⑤ Contact A..Q1: Closes when the comparison result "greater than", "equal to" or "less than" occurs, depending on the set operating mode GT, EQ or LT.
- ⑥ Contact A..CY: Closes when the permissible value range is exceeded.

**Wiring of the function block**

You wire the analog value comparator function block in the standard circuit diagram with its contacts. Example of a function block for comparing analog values:

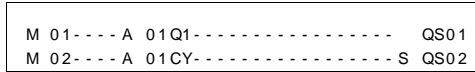
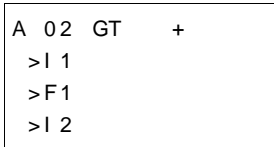

Figure 71: Wiring the contacts

**Parameters**

When using the function block in the circuit diagram for the first time, use OK to automatically enter the general display of function block parameters, as shown in the figure on the left. Enter the function block settings here. The display contains the following elements:



- >F2
- >OS
- >HY

A 02	Function block analog value comparator number 02
GT	Mode: Greater than
+	Parameter display: Call enabled
>I 1	Comparison value 1
>F1	Gain factor for >I1 (>I1 = >F1 x value)
>I 2	Comparison value 2
>F2	Gain factor for >I2 (>I2 = >F2 x value)
>OS	Offset for the value of >I1
>HY	Switching hysteresis for value >I2 (Value HY applies to positive and negative hysteresis.)

The parameters consist of the following:

**Operating mode**

This parameter defines which comparison result is to be used to close function block contact Q1.

Parameters	Function, parameterisation in the function block
GT	>I1 greater than >I2
EQ	>I1 equal to >I2
LT	>I1 less than >I2

The factory setting of this parameter is LT.

**Parameter display**

The display of the parameters during operation can be disabled. Further information can be found in section "Parameter assignment from the standard circuit diagram" on page 161.

Parameters	Function
+	Parameters are displayed
-	Parameters are not displayed

This parameter is factory set to +.

**Inputs**

The signals at function block inputs >I1 and >I2 are compared.

Parameters	Function
> I 1	Comparison value 1: -2147483648 - +2147483647
> I 2	Comparison value 2: -2147483648 - +2147483647

If required adjust the comparison values and increase them by entering gain factors >F1 and >F2.

- >F1 is permanently assigned to >I1.
- >F2 is permanently assigned to >I2.

Parameters	Function
>F1	Gain factor 1: -2147483648 - +2147483647
>F2	Gain factor 2: -2147483648 - +2147483647

You can use the offset input >OS to move the zero point of the function block input >I1.

Parameters	Function
>OS	Offset: -2147483648 - +2147483647

The >HY function block input is used for the positive and negative switching hysteresis of the input >I2.

Parameters	Function
>HY	Switching hysteresis: -2147483648 - +2147483647

All function block inputs can be assigned the following operands:

- Constant.
- Markers MD, MW, MB.
- Output ...QV> of a different function block

If they are not associated, the inputs have a default value of:

- >F1 and >F2 = 1
- >OS and >HY = 0

**Contacts**

The contacts of the function block are evaluated in the standard circuit diagram. A closed contact indicates:

Parameters	Function
A ... Q1	Comparison value reached
A ... CY	Value range exceeded

**Memory requirement**

The analog value comparator function block requires 68 bytes of memory plus 4 bytes per constant at the function block inputs.

**Operation of the function block**

The function block compares values present at the inputs >I1 and >I2. You control the comparison in the function block by setting other input parameters:

- Multiplication factors >F1 and >F2 for the comparison values 1 and 2,
- Offset of comparison value 1 via function block input >OS,
- Application of a switch hysteresis to comparison value 2 on >HY.

Contact Q1 indicates the comparison result "greater", "equal to" or "less" depending on the set operating mode.

Contact CY closes if the value range is exceeded. If an out-of-range value is signalled with CY = 1, Q1 remains in state 0. With the following formulae you can calculate the permissible value range.

$$-2^{31} F I1 \times F1 + OS F (2^{31} - 1) | CY = 0$$

$$-2^{31} F I2 \times F2 + HY F (2^{31} - 1) | CY = 0$$

$$-2^{31} F I2 \times F2 - HY F (2^{31} - 1) | CY = 0$$

The following signal diagram illustrates the function:

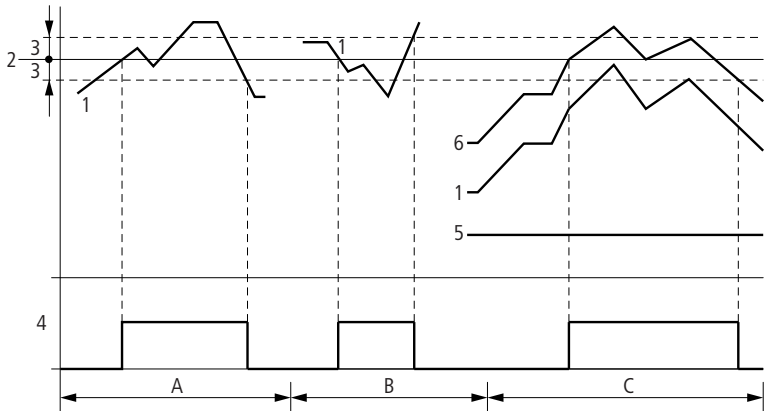

Figure 72: Signal diagram for analog value comparator

1: Actual value on &gt;I1

2: Setpoint value on &gt;I2

3: Hysteresis on &gt;HY

4: Switch contact (make)

5: Offset for value &gt;I1

6: Actual value plus offset

- Range A: Compare >I1 greater than >I2
  - The actual value >I1 increases.
  - The contact switches when the actual reaches the setpoint value.
  - The actual value changes and falls below the value of the setpoint value minus the hysteresis.
  - The contact goes to the normal position.
- Range B: Compare >I1 less than >I2
  - The actual value drops.
  - The contact switches if the actual value reaches the setpoint value.
  - The actual value changes and rises above the value of the setpoint value plus hysteresis.
  - The contact goes to the normal position.
- Range C: Compare >I1 greater than >I2 with offset
  - This example behaves as described in Range A. The offset value is added to the actual value.

- Comparison  $>I1$  equals  $>I2$

The contact switches on:

- If  $I1$  is equal to  $I2$ , i.e. the actual value is equal to the setpoint value.
- If  $I1$  is equal to  $I2$ , i.e. the actual value is equal to the setpoint value.

The contact switches off:

- If the hysteresis limit is exceeded with the actual value rising.
- If the hysteresis limit is undershot with the actual value decreasing.



## AR, arithmetic function block

The arithmetic function block is used for all four basic calculations:

- add
- subtract
- multiply
- divide.

easySafety allows the use of up to 16 arithmetic function blocks.

### Function block

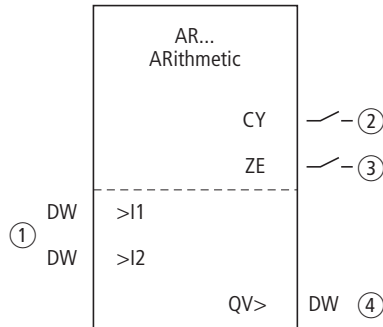

Figure 73: Arithmetic function block

- ① Inputs AR..I1 and AR..I2: The value at input I1 is associated with the value at I2 via the arithmetic operation.
- ② Contact A..CY: Closes when the permissible value range is exceeded.
- ③ Contact AR..ZE: Closes when the value at output AR..QV equals zero.
- ④ Output AR..QV: Outputs the calculation result.

### Wiring of the function block

An arithmetic function block does not require an enable or start signal and is therefore not wired in a coil field of the standard circuit diagram. The function block is provided with the two Boolean outputs mentioned above for controlling the calculation result that you wire as contacts in the standard circuit diagram. Example of an arithmetic function block:

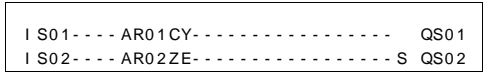
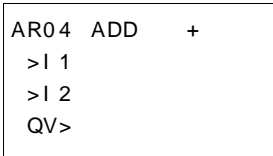

Figure 74: Wiring the function block contacts

### Parameters



When using the function block in the circuit diagram for the first time, use OK to automatically enter the general display of function block parameters, as shown in the figure on the left. Enter the function block settings here. The display contains the following elements:

AR04	Function block: Arithmetic, number 04
ADD	Mode: Add
+	Parameter display: Call enabled
>I 1	First value
>I 2	Second value
QV>	Result of the addition

The parameters consist of the following:

### Operating mode

This parameter is used to set the arithmetic operation required.

Parameters	Function, parameterisation in the function block
ADD	Addition of summand value >I1 plus summand >I2
SUB	Subtraction of minuend >I1 minus subtrahend >I2
MUL	Multiplication of factor >I1 by factor >I2
DI V	Division of dividend >I1 by divisor >I2

The factory setting of this parameter is ADD.

### Parameter display

The display of the parameters during operation can be disabled. Further information can be found in section "Parameter assignment from the standard circuit diagram" on page 161.

Parameters	Function
+	Parameters are displayed
-	Parameters are not displayed

This parameter is factory set to +.

### Inputs

The signals present at the inputs >I1 and >I2 are associated with the operation set as the mode.

Parameters	Function, parameterisation in the function block
>I 1	First value: -2147483648 - +2147483647
>I 2	Second value: -2147483648 - +2147483647

The function block inputs I1 and I2 can have the following operands:

- Constant.
- Markers MD, MW, MB.
- Output ...QV> of a different function block.

**Output**

The output provides the calculation result as an integer.

Parameters	Function, parameterisation in the function block
QV>	Value: -2147483648 - +2147483647

You can assign the following operands to output ...QV>:

- Markers MD, MW, MB and DWord inputs of other function blocks.

**Contacts**

The contacts of the function block are evaluated in the standard circuit diagram. A closed contact indicates:

Parameters	Function, parameterisation in the function block
AR. . CY	Value range exceeded
AR. . ZE	Result at output QV> is zero

**Memory requirement of the function block**

The arithmetic function block requires 40 bytes of memory plus 4 bytes per constant at the function block inputs.

**Operation of the function block**

The values present at the inputs >I1 and >I2 are associated with the arithmetic operation set as the mode.

If the calculation result exceeds the value range that can be represented, the overflow signal contact CY closes and output QV> contains the value of the last valid operation.

When the function block is called for the first time, the value at output QV> equals zero.

The following examples illustrate the functions of the function block for every arithmetic operation:

### Addition examples

- $42 + 1000 = 1042$
- $2147483647 + 1 =$  Last valid value before this arithmetic operation, due to overflow (CARRY)  
AR..CY = Status 1
- $-2048 + 1000 = -1048$

### Subtraction examples

- $1134 - 42 = 1092$
- $-2147483648 - 3 =$  Last valid value before this arithmetic operation, due to overflow (CARRY)  
AR..CY = Status 1
- $-4096 - 1000 = -5096$
- $-4096 - (-1000) = -3096$

### Multiplication examples

- $12 \times 12 = 144$
- $1000042 \times 2401 =$  Last valid value before this arithmetic operation, due to overflow (CARRY)  
Correct value = 2401100842  
AR..CY = Status 1
- $-1000 \times 10 = -10000$

### Division examples

- $1024 : 256 = 4$
- $1024 : 35 = 29$  (The places after the decimal point are omitted.)
- $1024 : 0 =$  Last valid value before this arithmetic operation, due to overflow (CARRY)  
(mathematically correct "Infinity")  
AR..CY = Status 1
- $-1000 : 10 = -100$
- $1000 : -10 = -100$
- $-1000 : (-10) = 100$
- $10 : 100 = 0$

**BC, data block comparator** The data block comparator function block compares two contiguous marker ranges. For this you define the number of bytes to be compared. The comparison is carried out in byte format for marker types MB, MW and MD.

easySafety allows the use of up to 16 data block comparators.

**Function block**

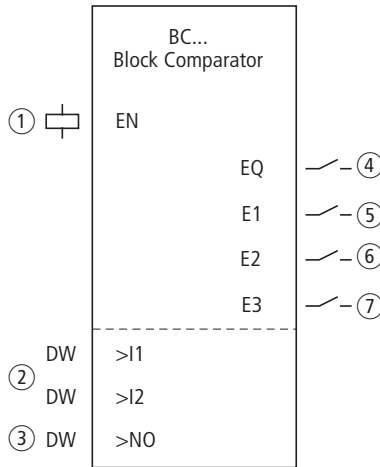

Figure 75: Data block comparator function block

- ① Coil BC..EN: Enables the operation of the function block.
- ② Inputs BC..I1 and BC..I2: The data block corresponding to the start address specified on input I1 is compared with the data block corresponding to the start address specified on input I2.
- ③ Input BC..NO: Number of bytes to be compared.
- ④ Contact BC..EQ: Closes when compared blocks are identical.
- ⑤ Contact BC..E1: Closes when the number of compared elements for a marker range are exceeded.
- ⑥ Contact BC..E2: Closes when compared blocks overlap.
- ⑦ Contact BC..E3: Closes when compared blocks are outside of the permitted range.

### Wiring of the function block

You wire the function block in the standard circuit diagram with its enable coil and its contacts. Example of a function block for comparing data blocks:

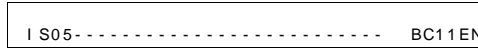

Figure 76: Wiring the enable coil

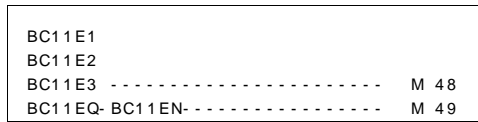
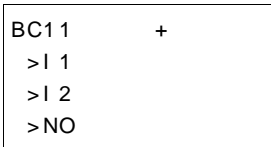

Figure 77: Wiring the contacts



### Parameters

When using the function block in the circuit diagram for the first time, use OK to automatically enter the general display of function block parameters, as shown in the figure on the left. Enter the function block settings here. The display contains the following elements:

BC11	Function block: Data block comparator, number 11
+	Parameter display: Call enabled
>I 1	Start of comparison range 1
>I 2	Start of comparison range 2
>NO	Number of elements to be compared in bytes per range

The parameters consist of the following:

**Parameter display**

The display of the parameters during operation can be disabled. Further information can be found in section "Parameter assignment from the standard circuit diagram" on page 161.

Parameters	Function
+	Parameters are displayed
-	Parameters are not displayed

This parameter is factory set to +.

**Inputs**

The marker ranges corresponding to the start addresses specified on inputs >I1 and >I2 are compared with each other.

Parameters	Function
>I 1	Start of comparison range 1
>I 2	Start of comparison range 2

The number of elements to be compared is defined at input >NO.

Parameters	Function
>NO	Number: 1 - 383

The function block inputs >I1, >I2 and >NO can have the following operands:

- Constant.
- Markers MD, MW, MB.
- Output ...QV> of a different function block.



**Specifying the marker range**

Marker ranges can be specified with or without an offset.

**Marker range without offset**

If MB, MW or MD markers are specified at both >I1 and >I2 the number of the markers is the start of comparison range.

**Marker range with offset**

If you wish to work with an offset, specify one of the following variables at function block input >I1 or >I2:

- Constant.
- Output ..QV> of a function block.

The value at the input is taken as the offset to marker byte MB01.

Example: A value of 0 at I1 means that the reference data block for the comparison begins at MB01. A value of 100 at I2 means that the target data block for the compare operation begins at MB101.

h

With the offset information you can address marker ranges (for example MB380), which you can not address when using marker operands (direct addressing).

Offset calculation for addressing marker words:

$$\text{Offset} = \text{MW} (x - 1) \times 2$$

Offset calculation for addressing marker double words:

$$\text{Offset} = \text{MD} (x - 1) \times 4$$

**Coil**

The coil of the function block is used in the standard circuit diagram.

Parameters	Function
BC. . EN	Selective activation of the function block

**Contacts**

The contacts of the function block are evaluated in the standard circuit diagram. A closed contact indicates:

Parameters	Function
BC. . EQ	Compared ranges are identical
BC. . E1	The number of compared elements for a marker range are exceeded.
BC. . E2	Compared ranges overlap
BC. . E3	Offset of compared blocks outside of the permitted range.

**Memory requirement**

The data comparator function block requires 48 bytes of memory plus 4 bytes per constant at the function block inputs.

**Operation of the function block**

The data block comparator function block compares two contiguous data blocks.

The comparator is active if coil BC..EN (enable) is triggered.

h

No data blocks are compared if an error is present.

The error outputs E1, E2 and E3 are evaluated regardless of the status of the enable.

### Example 1: Comparison of marker blocks, direct definition of marker ranges

Two marker blocks are to be compared. Block 1 starts at MB10, Block 2 starts at MB40. Each block is 10 bytes long.

- Parameters of function block BC01:
  - Comparison range 1: >I1 MB10
  - Comparison range 2: >I2 MB40
  - Number of bytes: >NO 10

Comparison range 1	Value of marker range 1 (decimal)	Comparison range 2	Value of marker range 2 (decimal)
MB10	39	MB40	39
MB11	56	MB41	56
MB12	88	MB42	88
MB13	57	MB43	57
MB14	123	MB44	123
MB15	55	MB45	55
MB16	134	MB46	134
MB17	49	MB47	49
MB18	194	MB48	194
MB19	213	MB49	213

The comparison result of the function block BC01 is: BC01EQ = 1, the data block ranges have the same content.

**Example 2: Comparison of marker blocks, definition of a marker range with offset**

Two marker blocks are to be compared. Block 1 starts at MB15, Block 2 starts at MB65. Each block is 4 bytes long.

- Parameters of function block BC01:
  - Comparison range 1: >I1 MB15
  - Comparison range 2: >I2 64
  - Number of bytes: >NO 4
  - Marker MB01: 1

h

Comparison range 2: Constant 64:  
 MB01 plus offset:  $1 + 64 = 65$  r MB65.

Comparison range 1	Value of marker range 1 (decimal)	Comparison range 2	Value of marker range 2 (decimal)
MB15	45	MB65	45
MB16	62	MB66	62
MB17	102	MB67	102
MB18	65	MB68	57

The comparison result of the function block BC01 is: BC01EQ = 0, the data block ranges do not have the same content. MB18 and MB68 are not identical.

### Example 3: Comparison of marker blocks, definition of a marker range in a different format.

Two marker blocks are to be compared. Block 1 starts at MB60, Block 2 starts at MD80. Each block is 6 bytes long.

- Parameters of function block BC01:
  - Comparison range 1: >I1 MB60
  - Comparison range 2: >I2 MD80
  - Number of bytes: >NO 6

h

The comparison is in byte format. MD80 has 4 bytes. Therefore the first two bytes of MD81 are also compared.

Comparison range 1	Value of marker range 1 (decimal/binary)	Comparison range 2	Value of marker range 2 (decimal/binary)
MB60	45/ 00101101	MD80 (Byte 1, LSB)	1097219629/ 01000001011001100011111000101101
MB61	62/ 00111110	MD80 (Byte 2)	1097219629/ 01000001011001100011111000101101
MB62	102/ 01100110	MD80 (Byte 3)	1097219629/ 01000001011001100011111000101101
MB63	65/ 01000001	MD80 (Byte 4, MSB)	1097219629/ 01000001011001100011111000101101
MB64	173/ 10101101	MD81 (Byte 1, LSB)	15277/ 0011101110101101
MB65	59/ 00111011	MD81 (Byte 2)	15277/ 0000100010101101

The data block ranges do not have the same content. BC01EQ = 0, MB65 and MD81 (Byte 2) are not identical.

**Example 4: Comparison of marker blocks, range violation error.**

Two marker blocks are to be compared. Block 1 starts at MD60, Block 2 starts at MD90. Each block is 30 bytes long.

- Parameters of function block BC01:
  - Comparison range 1: >I1 MD60
  - Comparison range 2: >I2 MD90
  - Number of bytes: >NO 30

**h**

The comparison is in byte format. MD90 to MD96 is 28 bytes. The number of bytes is 30 bytes.

The error message “Number of comparison elements exceeds one of the comparison ranges” is output.

BC01E1 is 1.

**Example 5: Comparison of marker blocks, range overlap error.**

Two marker blocks are to be compared. Block 1 starts at MW60, Block 2 starts at MW64. Each block is 12 bytes.

- Parameters of function block BC01:
  - Comparison range 1: >I1 MW60
  - Comparison range 2: >I2 MW64
  - Number of bytes: >NO 12

**h**

The comparison is in byte format. MW60 to MW64 is 8 bytes. The number of bytes is 12 bytes.

The error message “Comparison ranges overlap” is output.

BC01E2 is 1.

**Example 6: Comparison of marker blocks, invalid offset error.**

Two marker blocks are to be compared. Block 1 starts at MW40, block 2 at MW54. The block length is determined by the value of counter C 01QV.

- Parameters of function block BC01:
  - Comparison range 1: >I1 MW40
  - Comparison range 2: >I2 MW54
  - Number of bytes: >NO C 01QV

**h**

The value of C 01QV is 1024. This value is too big. The value at >NO can be between 1 and +383.

The error message "The specified offset of the comparison ranges is outside of the permissible range" is output.

BC01E3 is 1.

**BT, data block transfer**

The function block is used to transfer values from one marker range to another (copy data). The marker ranges can be overwritten with a particular value (data initialisation). The following marker types can be transferred and overwritten:

- MB.
- MW.
- MD.

easySafety allows the use of up to 16 data block transfer function blocks.

**Function block**

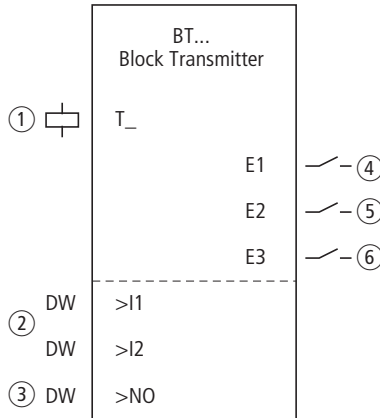

Figure 78: Data block transfer function block

- ① Coil BT..T\_: Trigger coil, function block transfers on rising edge.
- ② Inputs: BT..I1: Start of the source range or initialisation marker (MB,MW,MD). BT..I2: Start of destination range.
- ③ Input BT..NO: Number of bytes to be transferred.
- ④ Contact BT..E1: Closes when source or destination range is exceeded.
- ⑤ Contact BT..E2: Closes when source and destination range overlap.
- ⑥ Contact BT..E3: Closes when the offset is invalid.



**Wiring of the function block**

You wire the function block in the standard circuit diagram with its trigger coil and its contacts. Example of a block transfer function block:

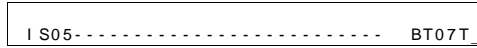

Figure 79: Wiring the trigger coil

The trigger coil is connected to a device input.

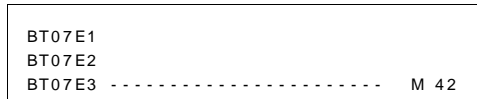
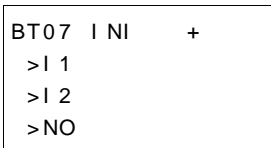

Figure 80: Wiring the contacts

The messages of the function block are sent as a group message to a marker.

**Parameters**

When using the function block in the circuit diagram for the first time, use OK to automatically enter the general display of function block parameters, as shown in the figure on the left. Enter the function block settings here. The display contains the following elements:



BT07	Function block: Data block transfer, number 07
I NI	Mode: INI
+	Parameter display: Call enabled
>I 1	Source range start
>I 2	Destination range start
>NO	Number of elements to be written in bytes per range

The parameters consist of the following:

**Operating mode**

The mode setting defines whether marker ranges are to be copied or initialised.

Parameters	Function
INI	Initialise marker ranges
CPY	Copy marker ranges

This parameter is factory set to INI.

**Parameter display**

The display of the parameters during operation can be disabled. Further information can be found in section "Parameter assignment from the standard circuit diagram" on page 161.

Parameters	Function
+	Parameters are displayed
-	Parameters are not displayed

This parameter is factory set to +.

**Inputs**

Function block inputs >I1 and >I2 are used to define the beginning of the source and destination range.

The entry at function block input >NO determines the number of elements to be written.

Parameters	Function
>I 1	Source range start
>I 2	Destination range start
>NO	Number: 1 - 192

The function block inputs >I1, >I2 and >NO can have the following operands:

- Constant.
- Markers MD, MW, MB.
- Output ...QV> of a different function block.

### Specifying the marker range

Marker ranges can be specified with or without an offset.

#### Marker range without offset

If MB, MW or MD markers are specified at both >I1 and >I2 the number of the markers is the start of comparison range.

#### Marker range with offset

If you wish to work with an offset, specify one of the following variables at function block input >I1 or >I2.

- Constant.
- Output ..QV of a function block.

The value at the input is taken as the offset to marker byte MB01.

h

With the offset information you can address marker ranges (for example MB380), which you can not address when using marker operands (direct addressing).

Offset calculation for addressing marker words:

$$\text{Offset} = \text{MW} (x - 1) \times 2$$

Offset calculation for addressing marker double words:

$$\text{Offset} = \text{MD} (x - 1) \times 4.$$

### Coil

The coil of the function block is used in the standard circuit diagram to transfer the input value.

Parameters	Function
BT..T_	Triggering the transfer on a rising edge

### Contacts

The contacts of the function block are evaluated in the standard circuit diagram. A closed contact indicates:

Parameters	Function
BT...E1	Exceeding the source or destination range
BT...E2	Overlapping of source and destination range
BT...E3	Invalid offset

### Memory requirement

The transfer data block function block requires 48 bytes of memory plus 4 bytes per constant at the function block inputs.

### Operation of the function block

The transfer data block function block has two operating modes.

h

No data blocks are initialised or copied if an error occurs.

#### INI mode, initialise marker ranges

There is one source range and one destination range. The source range is specified at >I1. The length of the source range is one byte. The destination range is specified at >I2. The length of the destination range is specified by the number of bytes at the >NO input.

The content of the source range is transferred to the marker bytes in the destination range.

The function block carries out a transfer on a rising edge at coil T\_ (Trigger).

The error contacts E1, E2 and E3 are evaluated regardless of the status of the trigger.

**Example 1:** Initialising marker blocks, direct definition marker ranges

The value of marker byte 10 is to be transferred to marker bytes 20 to 29.

- Parameters of function block BT01:
  - Source range: >I1 MB10
  - Destination range: >I2 MB20
  - Number of bytes: >NO 10

Source-range	Value of source marker range (decimal)	Destination range	Value of destination marker range (decimal)
MB10	123	MB20	123
		MB21	123
		MB22	123
		MB23	123
		MB24	123
		MB25	123
		MB26	123
		MB27	123
		MB28	123
		MB29	123

After a rising edge from 0 to 1 at coil BT01T\_ the value 123 is present in the marker bytes MB20 to MB29.

**Example 2:** Initialisation of marker blocks, definition of a range with offset

The content of marker byte MB15 is to be transferred to marker bytes MB65 to MB68.

- Parameters of function block BT01:
  - Source range: >I1 MB15
  - Destination range: >I2 64
  - Number of bytes: >NO 4
  - Marker MB01: 1

h

Destination range: Constant 64;  
 Marker MB01 plus offset:  $1 + 64 = 65$  r MB65.

Source range	Value of source marker range (decimal)	Destination range	Value of destination marker range (decimal)
MB15	45	MB65	45
		MB66	45
		MB67	45
		MB68	45

After a rising edge from 0 to 1 at coil BT01T\_ the value 45 is present in the marker bytes MB65 to MB68.

**Example 3:** Initialisation of marker blocks, transfer of a range to a different format.

The value of marker byte MB60 is to be transferred to MD80 and MD81.

- Parameters of function block BT01:
  - Source range: >I1 MB60
  - Destination range: >I2 MD80
  - Number of bytes: >NO 8

h

The transfer is in byte format. MD80 has 4 bytes and MD81 has 4 bytes, which means that >NO has the value 8.

Comparison range 1	Value marker range 1 (dec./binary)	Comparison range 2	Value of marker range 2 (decimal/binary)
MB60	45/ 00101101	MD80 (Byte 1, LSB)	757935405/ 001011010010110100101101 <b>00101101</b>
		MD80 (Byte 2)	757935405/ 0010110100101101 <b>00101101</b> 00101101
		MD80 (Byte 3)	757935405/ 00101101 <b>00101101</b> 0010110100101101
		MD80 (Byte 4, MSB)	757935405/ <b>00101101</b> 001011010010110100101101
		MD81 (Byte 1, LSB)	757935405/ 001011010010110100101101 <b>00101101</b>
		MD81 (Byte 2)	757935405/ 0010110100101101 <b>00101101</b> 00101101
		MD81 (Byte 3)	757935405/ 00101100 <b>01011011</b> 0010110100101101
		MD81 (Byte 4, MSB)	757935405/ <b>00101101</b> 001011010010110100101101

After a rising edge from 0 to 1 at coil BT01T\_ the value 757935405 is present in the marker double words MD80 and MD81.

**Example 4:** Transfer of marker byte, destination range violation error.

The value of marker byte MB96 is to be transferred to MD93, MD94, MD95 and MD96. The length is 16 bytes.

- Parameters of function block BT01:
  - Source range: >I1 MD96
  - Destination range: >I2 MD93
  - Number of bytes: >NO 18

h

The transfer is in byte format. MD93 to MD96 is 16 bytes. 18 bytes were incorrectly defined as length.

The error message "Number of elements exceeds the destination range" is output.

BT01E1 is 1.

**Example 5:** Transfer of marker bytes, invalid offset error.

The value of marker byte MB40 is to be transferred to MW54 and subsequent marker words. The block length is specified by the value of the counter C 01QV.

- Parameters of function block BT01:
  - Source range: >I1 MB40
  - Destination range: >I2 MW54
  - Number of bytes: >NO C 01QV

h

The value of C 01QV is 788. This value is too big. The value at >NO can be between 1 and +192.

The message "The specified offset of the destination range is outside of the permissible range" is output.

BT01E3 is 1.



**CPY mode, copy marker ranges**

There is one source range and one destination range. The source range is specified at >I1. The destination range is specified at >I2. The length of the source and destination range is specified by the number of bytes at the >NO input.

The content of the source range is copied to the marker bytes in the destination range.

The function block executes the copy operation if there is a rising edge from 1 to 1 at the BT..T\_ (Trigger) coil.

The error outputs E1, E2 and E3 are evaluated regardless of the status of the trigger.

**Example 1:** Copy of marker blocks, direct definition of marker ranges

The value of marker byte 10 to 19 is to be transferred to marker bytes 20 to 29.

- Parameters of function block BT01:
  - Source range: >I1 MB10
  - Destination range: >I2 MB20
  - Number of bytes: >NO 10

Source range	Value of source marker range (decimal)	Destination range	Value of destination marker range (decimal)
MB10	42	MB20	42
MB11	27	MB21	27
MB12	179	MB22	179
MB13	205	MB23	205
MB14	253	MB24	253
MB15	17	MB25	17
MB16	4	MB26	4

Source range	Value of source marker range (decimal)	Destination range	Value of destination marker range (decimal)
MB17	47	MB27	47
MB18	11	MB28	11
MB19	193	MB29	193

After a rising edge from 0 to 1 at coil BT01T\_ the content of MB10 to MB19 is copied to the marker bytes MB20 to MB29.

**Example 2:** Copying of marker blocks, definition of a range with offset

The content of marker bytes MB15 to MB18 is to be copied to marker bytes MB65 to MB68.

- Parameters of function block BT01:
  - Source range: >I1 MB15
  - Destination range: >I2 64
  - Number of bytes: >NO 4
  - Marker MB01: 1

h

Destination range: Constant 64:  
 Marker MB01 plus offset: 1 + 64 = 65 r MB65.

Source range	Value of source marker range (decimal)	Destination range	Value of destination marker range (decimal)
MB15	68	MB65	68
MB16	189	MB66	189
MB17	203	MB67	203
MB18	3	MB68	3

After a rising edge from 0 to 1 at coil BT01T\_ the content of MB15 to MB18 is copied to the marker bytes MB65 to MB68.

**Example 3:** Copying of marker blocks, definition of a range in a different format

Marker range MD60 to MD62 is to be copied to MW40 to MW45.

- Parameters of function block BT01:
  - Source range: >I1 MD60
  - Destination range: >I2 MW40
  - Number of bytes: >NO 12

h

The transfer is in byte format. 12 bytes are to be copied. The range MD60 to MD62 is 12 bytes. This is copied to the range MW40 to MW45.

Comparison range 1	Value of marker range 1 (decimal/binary)	Comparison range 2	Value of marker range 2 (decimal/binary)
MD60	866143319/ 0011001110100000 <b>0100110001010111</b>	MW40 (LSW)	19543/0011001110100000 <b>0100110001010111</b>
MD60	866143319/ <b>0011001110100000</b> 0100110001010111	MW41 (MSW)	13216/ <b>0011001110100000</b> 0100110001010111
MD61	173304101/ 0000101001010100 <b>0110100100100101</b>	MW42 (LSW)	26917/0000101001010100 <b>0110100100100101</b>
MD61	173304101/ <b>0000101001010100</b> 0110100100100101	MB43 (MSW)	2644/ <b>0000101001010100</b> 0110100100100101
MD62	982644150/ 0011101010010001 <b>1111010110110110</b>	MB44 (LSW)	62902/0011101010010001 <b>1111010110110110</b>
MD62	982644150/ <b>0011101010010001</b> 1111010110110110	MB45 (MSW)	14993/ <b>0011101010010001</b> 1111010110110110

After a rising edge from 0 to 1 at coil BT01T\_ the values are copied to the appropriate range.

**Example 4:** Copying of marker bytes, destination range violation error

Marker range MB81 to MB96 is to be transferred to MD93 to MD96. The length is 16 bytes.

- Parameters of function block BT01:
  - Source range: >I1 MB81
  - Destination range: >I2 MD93
  - Number of bytes: >NO 18

h

The transfer is in byte format. MD93 to MD96 is 16 bytes. 18 bytes were incorrectly defined as length.

The error message "Number of elements exceeds the destination range" is output.

BT01E1 is 1.

**Example 5:** Comparison of marker blocks, range overlap error

12 bytes are to be copied starting from MW60. MW64 is specified as destination address.

- Parameters of function block BT01:
  - Source range: >I1 MW60
  - Destination range: >I2 MW64
  - Number of bytes: >NO 12

h

The copy operation is in byte format. MW60 to MW64 is 8 bytes. The number of bytes is 12 bytes.

The error message "Both ranges overlap" is output.

BT01E2 is 1.

**Example 6:** Copying of marker bytes, invalid offset error.

The value of marker word MW40 is to be copied to MW54 and subsequent marker words. The block length is specified by the value of the counter C 01QV.

- Parameters of function block BT01:
  - Source range: >I1 MW40
  - Destination range: >I2 MW54
  - Number of bytes: >NO C 01QV

h

The value of C 01QV is 10042. This value is too big. The value at >NO can be between 1 and +383.

The message "The specified offset of the destination range is outside of the permissible range" is output.

BT01E3 is 1.

**BV, Boolean operation**

The function block enables the values to be combined in Boolean (logic) operations. It has the following functions:

- Masking out of particular bits from values,
- Bit pattern recognition,
- Bit pattern modification.

easySafety allows the use of up to 16 Boolean operations.

**Function block**

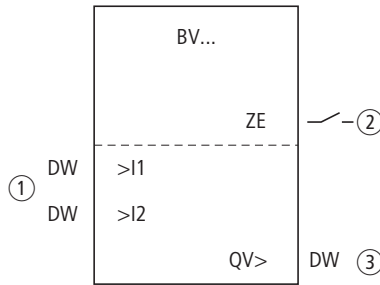

Figure 81: Boolean operation function block

- ① Inputs BV..I1 and BV..I2: The data block at input I1 is compared with the value at I2.
- ② Contact BV..ZE: Closes if operation result equals zero.
- ③ Output BV..QV: Outputs the operation result.

**Wiring of the function block**

You wire the function block in the standard circuit diagram with its contact. Example of a function block for Boolean operation:

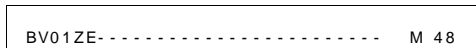

Figure 82: Wiring of the contact to marker

BV01	AND	+
>I 1		
>I 2		
QV>		

### Parameters

When using the function block in the circuit diagram for the first time, use OK to automatically enter the general display of function block parameters, as shown in the figure on the left. Enter the function block settings here. The display contains the following elements:

BV01	Function block: Boolean operation, number 01
AND	Mode: AND
+	Parameter display: Call enabled
>I 1	First value
>I 2	Second value
QV>	Result of the association

The parameters consist of the following:

### Operating mode

This parameter is used to set the type of operation required.

Parameters	Function
AND	AND operation
OR	OR operation
XOR	Exclusive OR operation
NOT	Negation of the Boolean value of >I1

The factory setting of this parameter is AND.

### Parameter display

The display of the parameters during operation can be disabled. Further information can be found in section "Parameter assignment from the standard circuit diagram" on page 161.

Parameters	Function
+	Parameters are displayed
-	Parameters are not displayed

This parameter is factory set to +.

### Inputs

You set the values to be associated at function block inputs >I1 and >I2.

Parameters	Function
>I 1	First value: 32-bit
>I 2	Second value: 32-bit

The function block inputs >I1 and >I2 can have the following operands:

- Constant.
- Markers MD, MW, MB.
- Output ...QV> of a different function block.

### Output

Outputs the operation result.

Parameters	Function, parameterisation in the function block
qV>	Value: 32-bit

You can assign the following operands to output ...QV>:

- Markers MD, MW, MB.





**XOR Boolean operation**

Value >I1:  $13219_{\text{dez}} = 0011001110100011_{\text{bin}}$

Value >I2:  $57193_{\text{dez}} = 1101111101101001_{\text{bin}}$

Result QV>:  $60618_{\text{dez}} = 1110110011001010_{\text{bin}}$

**NOT Boolean operation**

Value >I1:  $13219_{\text{dez}} =$   
 $0000000000000000011001110100011_{\text{bin}}$

Value >I2: deleted

Result QV>:  $-13220_{\text{dez}} =$   
 $1111111111111111100110001011100_{\text{bin}}$

The NOT sequence operates according to the following rules:

>I1, positive value

Subtract value of >I1 and 1:

$$-|>I1| - 1 = >I2$$

>I1, negative value

Subtract value of >I1 and 1:

$$-|>I1| - 1 = >I2$$

**C, counter relay**

The counter relay (function relay) counts pulses that are received at counter input C\_. The count direction can be set.

**h**

Counting is carried out cyclically. The time of a pulse must therefore be greater than twice the cycle time.

You can set a lower and higher limit setpoint as comparison values for the counter relay function block, as well as a start value.

easySafety allows the use of up to 16 counter relays.

**h**

Square wave count pulses are required to ensure a 1:1 mark to space ratio.

The relay counts only in RUN mode.

**h**

page 337 on Example with timing relay and counter function block provides information on the timing relay and counter function block.

**Function block**

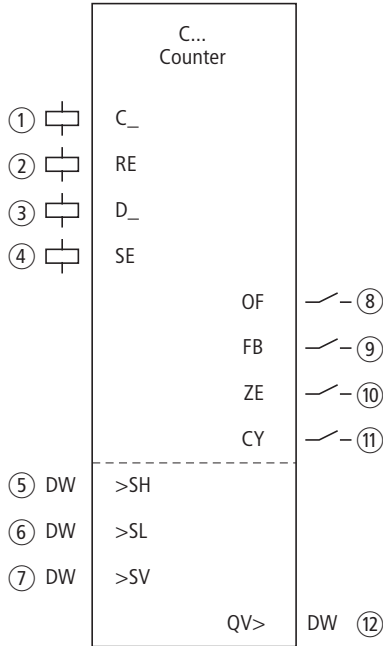

Figure 83: Counter relay function block

- ① Coil C..C\_: Count coil, starts function block counting with every rising edge.
- ② Coil C..RE: Resets the counter relay to zero.
- ③ Coil C..D\_: Sets the count direction:  
Closed: Up counting,  
Open: Down counting.
- ④ Coil C..SE: Transfers the start value on a rising edge.
- ⑤ Input C..SH: Sets the upper limit setpoint.
- ⑥ Input C..SL: Sets the lower limit setpoint.
- ⑦ Input C..SV: Sets the start value.
- ⑧ Contact C..OF: Closes on reaching or exceeding the upper limit setpoint.
- ⑨ Contact C..FB: Closes on reaching or falling below the lower limit setpoint.
- ⑩ Contact C..ZE: Closes when the actual value equals zero.

- ⑪ Contact C..CY: Closes if the value range is exceeded for a cycle per rising count edge. If it is closed, the function block retains the value of the last valid operation.
- ⑫ Actual value output C..QV: Outputs the current actual value.

### Wiring of the function block

You wire the function block in the standard circuit diagram with its coils and its contacts. Example of a counter relay:

I S05-----	C 01C_
I S06-----	C 01RE
I S07-----	C 01D_
I S08-----	C 01SE

Figure 84: Wiring the function block coils

The function block coils are connected to the device inputs.

C 01OF-----	M 01
C 01FB-----	M 02
C 01ZE-----	M 03
C 01CY-----	S M 42

Figure 85: Wiring the contacts

The messages of the function block are sent to markers.

C 16            +  
 > SH  
 > SL  
 > SV  
 QV>

**Parameters**

When using the function block in the circuit diagram for the first time, use OK to automatically enter the general display of function block parameters, as shown in the figure on the left. Enter the function block settings here. The display contains the following elements:

c 16	Function block: Counter relay, number 16
+	Parameter display: Call enabled
>SH	Upper setpoint
>SL	Lower setpoint
>SV	Start value (Preset)
QV>	Actual value

The parameters consist of the following:

**Parameter display**

The display of the parameters during operation can be disabled. Further information can be found in section "Parameter assignment from the standard circuit diagram" on page 161.

Parameters	Function
+	Parameters are displayed
-	Parameters are not displayed

This parameter is factory set to +.

### Inputs

The upper and lower limit setpoints are set at function block inputs >SH and >SL respectively.

The start value is used to cause the function block to count from a specified offset value.

Parameters	Function
>SH	Upper setpoint: -2147483648 - +2147483647
>SL	Lower setpoint: -2147483648 - +2147483647
>SV	Start value: -2147483648 - +2147483647

The function block inputs >SH, >SL and >SV can have the following operands:

- Constant.
- Markers MD, MW, MB.
- Output ...QV> of a different function block.

### Output

Actual value output C..QV supplies the current actual value as an integer.

Parameters	Function
>QV	Actual value: -2147483648 - +2147483647

You can assign the following operands to output ...QV>:

- Markers MD, MW, MB.

### Coils

The coils of the function block are used in the standard circuit diagram.

Parameters	Function
C . . C_	Count coil, starts counting with rising edges
C . . RE	Reset of the counter relay to zero
C . . D_	Count direction setting
C . . SE	Transfer of the start value on a rising edge.

### Contacts

The contacts of the function block are evaluated in the standard circuit diagram. A closed contact indicates:

Parameters	Function
C . . OF	Reaching or exceeding the upper limit setpoint
C . . FB	Reaching or falling below the lower limit setpoint
C . . ZE	Actual value equals zero
C . . CY	Value range exceeded

### Memory requirement

The counter relay function block requires 52 bytes of memory plus 4 bytes per constant at the function block inputs.

### Retention

Counter relays can be operated with retentive actual values. The number of retentive counter relays can be selected in the SYSTEM r RETENTION menu. The retentive actual value requires 4 bytes of memory.

If a counter relay is retentive, the actual value is retained when the operating mode changes from RUN to STOP as well as when the power supply is switched off. When is started in RUN mode, the counter relay continues with the retentively stored actual value. If easySafety is started in RUN mode, the timing relay operates with the retentively saved actual value.



Operation of the function block

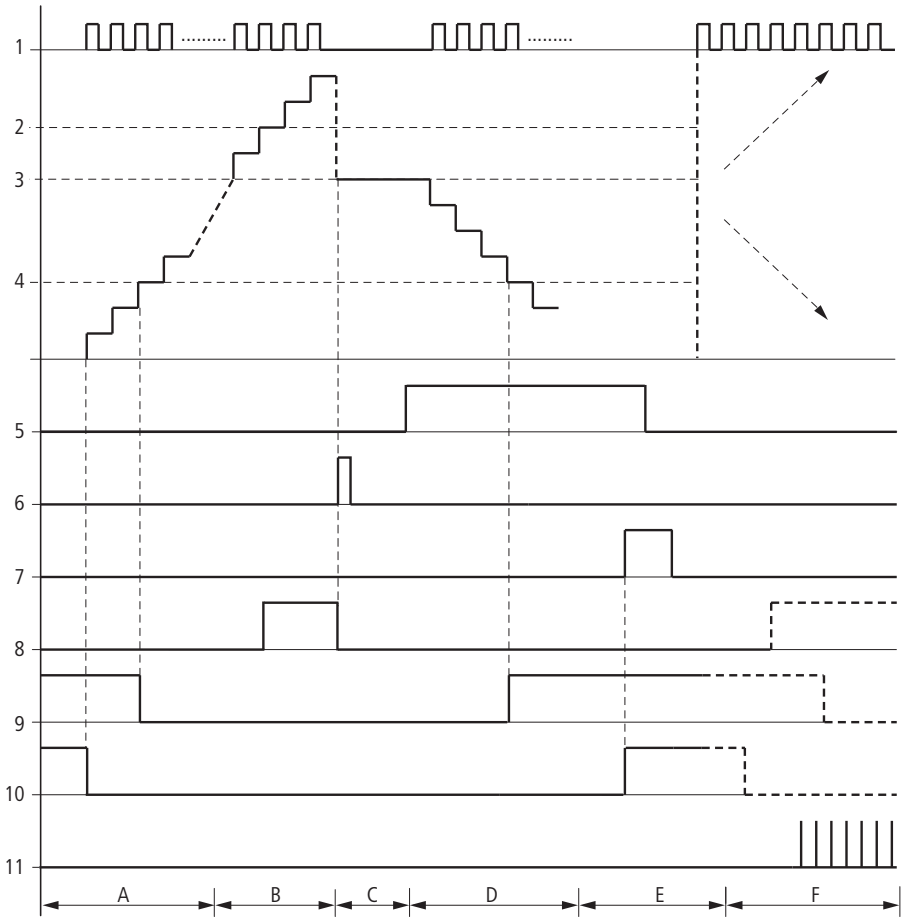

Figure 86: Signal diagram of counter relay

Legends to figure 86:

1: Counter coil C..C\_

2: Upper setpoint value >SH

3: Start value >SV.

4: Lower setpoint value >SL.

5: Counting direction, coil C..D\_

6: Transfer start value, coil C..SE.

7: Reset coil C..RE

8: Contact (make contact) C..OF: Upper limit setpoint reached, exceeded

9: Contact (make contact) C..FB lower limit setpoint reached, undershot

10: Actual value equal to zero.

11: Out of value range

- Range A:
  - The counter range has the value zero.
  - The contacts C..ZE (actual value equal to zero) and C..FB (lower setpoint value undershot) are active.
  - The counter receives pulses and increases the actual value.
  - C..ZE drops out as well as C..FB after the lower setpoint value is reached.
- Range B:
  - The counter relay counts upwards and reaches the upper setpoint value. The “upper setpoint value reached” contact C..OF becomes active.
- Range C:
  - The coil C..SE is briefly actuated and the actual value is set to the start value. The contacts go to the respective position.
- Range D:
  - The counting direction coil C..D\_ is actuated. If counting pulses are present, downward counting is initiated.
  - If the lower setpoint value is undershot, the contact C..FB becomes active.
- Range E:
  - The reset coil C..RE is activated. The actual value is set to zero.
  - The contact C..ZE is active.
- Range F:
  - The actual value goes outside the value range of the counter relay.
  - The contacts become active according to the direction of the values (positive or negative).

**CP, comparator**

This function block is used to compare variables and/or constants with each other. The following comparisons are possible:

- >I1 greater than >I2
- >I1 equal to >I2
- >I1 less than >I2

easySafety allows the use of up to 16 comparators.

**Function block**

Figure 87: Comparator function block

- ① Inputs CP..I1 and CP..I2: The value at input I1 is compared with the value at I2.
- ② Contact CP..LT: Closes on >I1 less than >I2.
- ③ Contact CP..EQ: Closes on >I1 equal to >I2.
- ④ Contact CP..GT: Closes on >I1 greater than >I2.

**Wiring of the function block**

You wire the function block in the standard circuit diagram with its contacts.

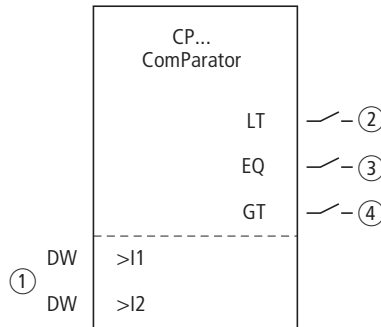
Example:

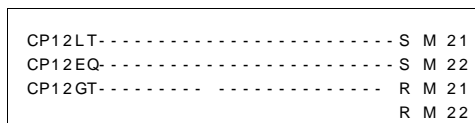
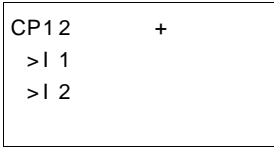

Figure 88: Wiring the function block contacts

The contact of the function block is sent to markers.

**Parameters**



When using the function block in the circuit diagram for the first time, use OK to automatically enter the general display of function block parameters, as shown in the figure on the left. Enter the function block settings here. The display contains the following elements:

CP12	Function block: Data block comparator, number 12
+	Parameter display: Call enabled
>I 1	First value
>I 2	Second value

The parameters consist of the following:

**Parameter display**

The display of the parameters during operation can be disabled. Further information can be found in section "Parameter assignment from the standard circuit diagram" on page 161.

Parameters	Function
+	Parameters are displayed
-	Parameters are not displayed

This parameter is factory set to +.

**Inputs**

The signals at function block inputs >I1 and >I2 are compared.

Parameters	Function, parameterisation in the function block
>I 1	Comparison value 1: -2147483648 - +2147483647
>I 2	Comparison value 2: -2147483648 - +2147483647

The function block inputs I1 and I2 can have the following operands:

- Constant.
- Markers MD, MW, MB.
- Output ...QV> of a different function block.

### Contacts

The contacts of the function block are evaluated in the standard circuit diagram. A closed contact indicates:

Parameters	Function, parameterisation in the function block
CP. . LT	>I1 less than >I2
CP. . EQ	>I1 equal to >I2
CP. . GT	>I1 greater than >I2

### Memory requirement

The function block requires 32 bytes of memory plus 4 bytes per constant at the function block inputs.

### Operation of the function block

The function block compares values present at the inputs >I1 and >I2.

The following contacts close depending on the comparison result:

- >I1 greater than >I2, GT closes.
- >I1 equal to >I2, EQ closes.
- >I1 less than >I2, LT closes.

**D, text display**

This function block is used to output text with/without variables on the device display. These variables can be actual values and setpoints of function blocks, marker values, analog inputs/outputs as well as date and time. The display/ keypad allows you to enter a setpoint for a function block if it is defined as a constant. The SP function block can be used to output the text and the variables via the multi-function interface to a peripheral device such as a terminal.

easySafety allows the use of up to 16 function blocks for text display.

The easySoft-Safety configuration software is used for editing the individual text lines in the Parameters tab. Carry this out for every D function block used. This is where you also set the variable to be shown. A detailed description of this topic is provided in the easySoft-Safety online help.

**Function block**

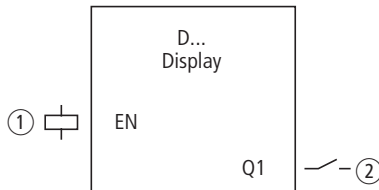

Figure 89: Text display function block

- ① Coil D..EN: Enables the operation of the function block.
- ② Contact D..Q1: Closes during text display.

**Wiring of the function block**

You wire the function block in the circuit diagram with its coil and its contact.

Example of a text function block:

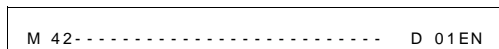

Figure 90: Wiring the enable coil

The enable coil of the function block is triggered by a marker.

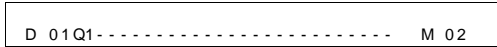

Figure 91: Wiring of the function block contact

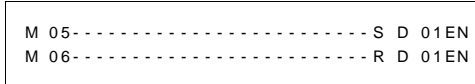
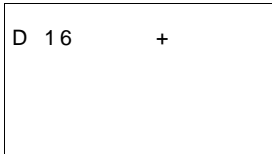

Figure 92: Wiring the enable coil with Set/Reset



**Parameters**

When using the function block in the circuit diagram for the first time, use OK to automatically enter the general display of function block parameters, as shown in the figure on the left. Enter the function block settings here. The display contains the following elements:

D16	Function block: Text output, number 16
+	Parameter display: Call enabled

**Parameter display**

The display of the parameters during operation can be disabled. Further information can be found in section “Parameter assignment from the standard circuit diagram” on page 161.

Parameters	Function
+	Parameters are displayed
-	Parameters are not displayed

This parameter is factory set to +.

**Coil**

The coils of the function block are used in the standard circuit diagram.

Parameters	Function
D . . EN	Selective activation of the function block

**Contact**

The contact of the function block is evaluated in the standard circuit diagram. It closes when the function block is active.

Parameters	Function
D . . Q1	Display of text

**Memory requirement**

The text display function block requires 160 bytes of memory irrespective of the size of the text.

**Display**

Up to 16 characters per line and up to 4 lines can be displayed.

**Displaying a variable**

The function block enables the display of:

- Actual values/setpoints of all function blocks except for HW and HY.
- Markers (MB, MW and MD).
- Date and time.

The variables and setpoints can be inserted at any desired position in the single-line text. The variables can be 4, 5, 7 and 11 places long. Incorrect entries can cause characters to be overwritten or hidden.

The following formats for timing relay, time and date are supported.

CONTROL  
 SWITCHING  
 COMMUNICATION  
 SIMPLY EASY



Variable	Format
Timing relays	s s s . s s s
	min min : s s
	h h : min min
Time	h h : min min
Date	DD.MM : YYYY

### Entering setpoints via keypad/display

The function block setpoints shown on the display and which can be defined as constants can be edited. The possibility of editing must be activated in the programming software. The values can be 4, 5, 7 and 11 places long. Incorrect entries can cause characters to be overwritten or hidden.

### Function

The text is output if you activate the EN coil. For this the status display must be active before the text display is called.

If the coil (EN) is returned to 0, the control relay display reactivates the status display after 4 s.

The additional Central Europe and Cyrillic fonts can also be used for the text display and combined with the display attributes Flashing and Inverse. These options can be set for individual lines, and the attributes can be used in any combination.

### Different behaviour of the function blocks D01 and D02 to D16

D01 outputs an alarm text: If D01 is activated, the text assigned to it will be displayed until:

- The coil D01 is reset to 0.
- STOP mode is selected.
- The easySafety device is switched off.
- The OK or DEL + ALT buttons are used to switch to a menu.

**D 02 to D 16:** If several texts are present and are triggered, each text is automatically displayed in turn every 4 s. This process will be repeated until:

- No other text display function block is set to 1.
- STOP mode is selected.
- The easySafety device is switched off.
- The OK or DEL + ALT buttons are used to switch to a menu.
- The text for D01 is displayed.

The function of the text display function is fully simulated by the Simulation tool.

**Displayable character set**

You can enter characters from the character maps “Western European”, “Central European” and “Cyrillic”.

Example characters from the character map “Western European”:

A B C D E F G H I J K L M N O P Q R S T U V W X Y Z  
 a b c d e f g h i j k l m n o p q r s t u v w x y z  
 0 1 2 3 4 5 6 7 8 9

Examples of special characters:

° ! " # \$ % & ' ( ) \* + , - . / : ; < = > ? [ \ ] ^ \_ ` { | } ~ . and space.

## Display examples

Counter with actual value

```
QUANTI TY
QTY: 0042
! COUNTING!
```

Temperature values of an easyNet station

```
TEMPERATURE
OUT - 010 DEG
IN 018 DEG
HEAT . .
```

D1 as error message on fuse failure

```
FUSE FAULT

HOUSE 1
FAI LED!
```

Figure 93: Text output examples

## Setpoint entry in a display

h

When values are being entered, the text is retained statically on the display. The actual values are updated.

```
ACT T01: 00:00
SETP : 012:00
ACT C16: 04711
SETP : 10000
```

Example:

The setpoint of timing relay T01 is to be changed from 12 s to 15 s.

- Line 1: Actual value of timing relay T 01
- Line 2: Setpoint of timing relay T 01, editable

```
ACT T01: 00:00
SETP : 012:00
ACT C16: 04711
SETP : 10000
```

X Pressing the ALT button will cause the cursor to jump to the first editable value.

In this operating mode, you can use the cursor buttons to move between editable constants.

```
ACT T01: 00:00
SETP : 012:000
ACT C16: 04711
SETP : 10000
```

X Press the OK button to move the cursor to the least significant value of the constant to be modified.

In this operating mode you use the cursor buttons to change the value. Use the cursor buttons to move between places.

Use the OK button to accept the modified value. Use the ESC button to abort the entry and leave the previous value.

```
ACT T01: 00:00  
SETP  : 015:00  
ACT C16: 04711  
SETP  : 10000
```

X Press the OK button, the cursor will move from constant to constant.

The modified value is accepted.

Press the ALT button in order to leave Entry mode. (the ESC button has the same function here.)

**DB, data block**

The function block stores values such as setpoints for function blocks. The value applied to input I1 is saved in the operand linked to output QV.

easySafety allows the use of up to 16 data function blocks.

**Function block**

Figure 94: Data function block

- ① Coil DB..T\_: Trigger coil, function block transfers on a rising edge.
- ② Input DB..I1: Input value.
- ③ Contact DB..Q1: Closes on a rising edge at DB..T\_.
- ④ Output DB..QV: Outputs the value of DB..I1 when triggered.

**Wiring of the function block**

You wire the function block in the standard circuit diagram with its trigger coil and its contact.

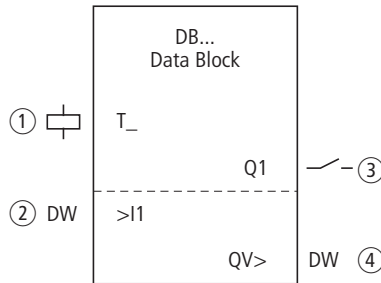
Example of a data function block:

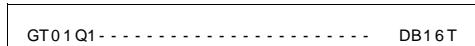

Figure 95: Wiring the trigger coil

The trigger coil is addressed via the NET.

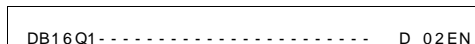
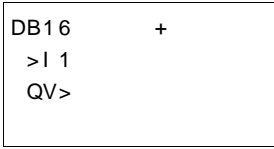

Figure 96: Wiring of the function block contact

The output of the data function block DB16Q1 is assigned to the input D02 EN of the text display function block.

**Parameters**



When using the function block in the circuit diagram for the first time, use OK to automatically enter the general display of function block parameters, as shown in the figure on the left. Enter the function block settings here. The display contains the following elements:

DB 16	Function block: Data function block, number 16
+	Parameter display: Call enabled
>I 1	Input value
QV>	Output value

The parameters consist of the following:

**Parameter display**

The display of the parameters during operation can be disabled. Further information can be found in section "Parameter assignment from the standard circuit diagram" on page 161.

Parameters	Function
+	Parameters are displayed
-	Parameters are not displayed

This parameter is factory set to +.

**Input**

You apply the value that is transferred on triggering to the function block input >I1.

Parameters	Function
>I 1	Input value

The function block input >I1 can be assigned the following operands:

- Constant.
- Markers MD, MW, MB.
- Output ...QV> of a different function block.

### Output

The output provides the input value when triggered as an integer.

Parameters	Function, parameterisation in the function block
QV>	Output value: -2147483648 - +2147483647

You can assign the following operands to output ...QV>:

- Markers MD, MW, MB.

### Coil

The coil of the function block is used in the standard circuit diagram to transfer the value at input >I1 to the function block and supply it on its output.

Parameters	Function
DB. . T_	Transfer the value to >I1

### Contact

The contact of the function block is evaluated in the standard circuit diagram. A closed contact indicates that the transferred value is output on the output.

Parameters	Function
DB. . Q1	Transfer of the value from >I1 to QV>

**Memory requirement**

The data block function block requires 36 bytes of memory plus 4 bytes per constant at the function block input.

**Retention**

Data function blocks can be operated with retentive actual values. The quantity can be selected in the SYSTEM r RETENTION menu.

**Operation of the function block**

The value at input >I1 is only transferred with a rising trigger edge to an operand (e.g.: MD42) at output QV>. It contains the value up to the next time it is overwritten.

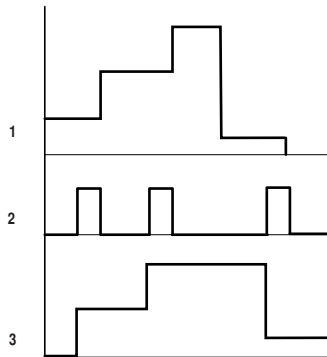

Figure 97: Signal diagram of data function block

- 1: Value at input DB..>I1
- 2: Trigger coil DB...T\_
- 3: Value on DB...QV>



## DG, diagnostics

The diagnostics function block (DG function block) evaluates the status messages of a safety function block. A status message is connected in the standard function block diagram with a contact of the DG function block. The contact closes if the message occurs. This can be responded to in the user program: To do this create a text using the text display function block. After the contact closes, the text can be shown on the display or on a connected visualization device. The DG function block can only be edited with the easySoft-Safety configuration software. This allows the use of up to 16 diagnostics function blocks.

### Function block

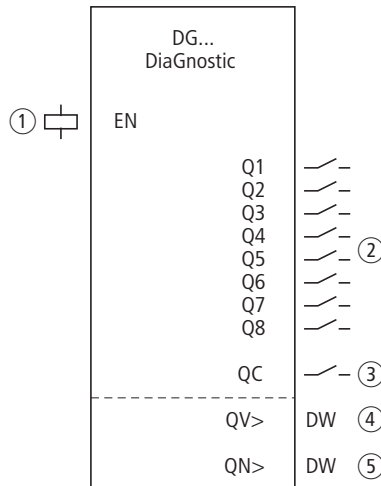

Figure 98: "Diagnostics" function block

- ① Coil DG..EN: Enables the operation of the DG function block.
- ② Contacts DG..Q1 to DG..Q8: Indicates the status of the safety function block.
- ③ Contact DG..QC: Outputs a group message (OR operation) for the 8 contacts Q1..Q8.
- ④ Output DG..QV: Supplies the status code from the diagnostics register of the safety function block.
- ⑤ Output DG..QN: Supplies the status of all contacts Q1..Q8 of the DG function block (double word format).

### Wiring a diagnostics function block

You wire the function block in the standard circuit diagram with its coil and its contacts.

The enable coil of the DG function block is connected to a device input.

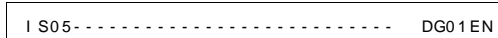

Figure 99: Wiring the coil in the standard circuit diagram

The contacts are assigned to markers.

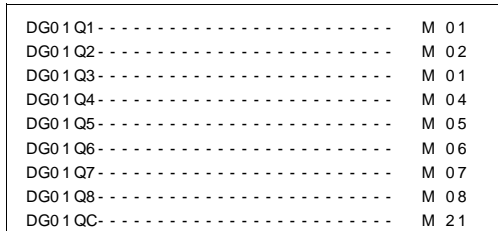
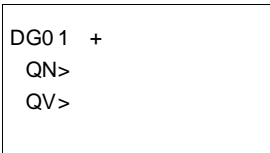

Figure 100: Wiring the output contacts

### Parameters

When using the DG function block in the circuit diagram for the first time, press OK to enter the general display of the function block parameters automatically, as shown in the figure on the left. This enables you to set the outputs QV and QN. The display contains the following elements:



DG01	Function block: Diagnostics, number 01
+	Parameter display: Call enabled
QV	Status code of the safety function block
QN	Display of all outputs Q1-Q8 of the DG function block

The parameters consist of the following:

### Parameter display

The display of the parameters during operation can be disabled. Further information can be found in section "Parameter assignment from the standard circuit diagram" on page 161.

Parameters	Function
+	Parameters are displayed
-	Parameters are not displayed

This parameter is factory set to +.

### Outputs

Output QV> provides information on the status of the selected safety function block.

A safety function block indicates its status in the form of a hexadecimal code at the output DG (diagnostics register). This code is also shown at output QV of the DG function block.

h

The section "Diagnostics/-Error codes" on page 618 and the online help section "DWord output of the safety function blocks" provides further information on the status messages and an overview of status messages and codes.

Example:

Status number (code)		Status message
hex	decimal	
2011	8209	Foot switch (FS) not actuated

Output QN> supplies the status of all contacts Q1..Q8 in byte 0 of the double word.

Byte 3	Byte 2	Byte 1	Byte 0					
–	–	–	Bit 8	7	6	... 3	2	1
–	–	–	Q8	Q7	Q6	... Q3	Q2	Q1

Parameters	Function, parameterisation in the function block
QV>	Status code of the safety function block
QN>	Display of all outputs Q1-Q8 of the DG function block

You can assign the following operands to the outputs:

- Markers MD, MW, MB.

### Coil

The coil of the DG function block is used in the safety or in the standard circuit diagram.

Parameters	Function
DG. . EN	Activation of the function block

### Contacts

The contacts of the DG function block indicate the states of a safety function block.

Contact	Function
DG. . Q1 ... DG. . Q8	The contacts DG..Q1 - Q8 close if the corresponding state is present in the monitored safety function block.
DG. . QC	Group message: If one of the contacts Q1-Q8 closes, DG..QC also closes.

**Memory requirement**

The DG function block requires 104 bytes of memory plus 4 bytes per constant at the function block inputs.

**Operation of the function block**

A DG function block is assigned to a safety function block. The safety function block indicates its status at its DG output (diagnostics register). This status, such as "Foot switch not actuated" with the FS safety function block, can be assigned to a contact of the DG function block in the standard function block diagram. If the status occurs at the safety function block, the assigned contact will close on the DG function block. The 8 contacts of a DG function block allow 8 states to be associated with the contacts. If a safety function block has more than 8 states, a second DG function block can process the additional status messages.

The DG function block is assigned to the corresponding safety function block in the standard function block diagram. After you have dragged the DG function block into this diagram, right-clicking the function block with the mouse will call up its Parameters tab. First associate the safety function block with the DG function block. To do this enter the number of the DG function block and enter in the Safety function block field the type of safety function block you have entered in the safety circuit diagram. The Safety function block states field shows 8 outputs of the DG function block with a status menu from which you can select the required status message.

If the safety function block takes on one of these states, the DG..Q signal contact assigned to it will close. The contacts of the function block are associated in the standard circuit diagram.

**GT, get value from the NET** With function block GT (from GET) you can poll a 32-bit value from the easyNet network . The easyNet network is referred to as NET below. GET function block GT automatically fetches the data designated for itself as soon as it is provided on the NET by another NET station using PUT function block PT. This 32-bit value can be used in the standard circuit diagram.

easySafety allows the use of up to 16 GT function blocks.

**Function block**

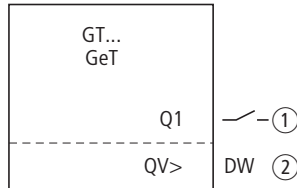

Figure 101: Function block GT

- ① Contact GT..Q1: Closes after a new 32 bit value is received.
- ② Output GT..QV: Outputs the received 32-bit value.

**Wiring of the function block**

You wire the function block with its signal contact in the standard circuit diagram.

Example of a GT function block:

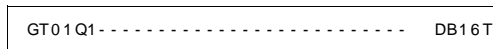

Figure 102: Wiring of the function block contact

The contact triggers a data function block.

```
GT01 02 11 +
QV>
```

### Parameters

When using the function block in the circuit diagram for the first time, use OK to automatically enter the general display of function block parameters, as shown in the figure on the left. Enter the function block settings here. The display contains the following elements:

GT01	Function block: GT, number 01
02	Number of the sending station.
11	Send function block (PT 11) of the sending station.
+	Parameter display: Call enabled
QV>	32-bit value from the NET

The parameters consist of the following:

#### Number of the sending station.

The non safety-related NET network can connect up to 8 stations that exchange non safety-related data with each other. The stations are identified by their station number. Further information on the NET is provided in chapter "easyNet network" from page 521.

Parameters	Function
02	Number of the sending station. Possible station numbers: 01 to 08

#### Number of the send function block

The sending station has 16 function blocks for transmitting 32-bit values to the network.

Parameters	Function
11	Send function block (PT 11) of the sending station. Possible function block number: 01 to 16

**Parameter display**

The display of the parameters during operation can be disabled. Further information can be found in section “Parameter assignment from the standard circuit diagram” on page 161.

Parameters	Function
+	Parameters are displayed
-	Parameters are not displayed

This parameter is factory set to +.

**Output**

The output provides the value fetched from the network for one operating cycle.

Parameters	Function, parameterisation in the function block
QV>	Value: -2147483648 - +2147483647

You can assign the following operands to output ...QV>:

- Markers MD, MW, MB.

**Contact**

The contact of the function block is evaluated in the standard circuit diagram. A closed contact indicates that new data have been received through the NET and are available at function block output QV.

Parameters	Function
GT . . Q1	Fetched value present at QV>

**Memory requirement**

The GT function block requires 28 bytes of memory.

**GT diagnostics**

The GT function block only functions if the easyNet network is running properly (a section “Checking the functionality of the NET”, page 543).



**Operation of the function block**

Figure 103: Signal diagram of GT function block

1: GT..Q1

2: Value on GT...QV&gt;

**h**

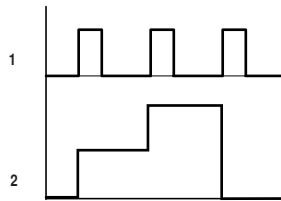
The GT function blocks are assigned the value 0 when the power supply is switched on.

**HW, seven-day time switch**

easySafety is equipped with a real-time clock which you can use in the standard circuit diagram as a 7-day time switch and a year time switch.

h

The procedure for setting the time is described under section "Setting date and time" on page 584.

easySafety allows the use of up to 16 7-day time switches.

h

Each time switch function block provides four channels which can each be assigned with a time for on and off switching. The channels are set via the parameter display.

The timer has a back-up battery. Although the time switch relays will no longer switch. When easy is in a de-energized state, the timer contacts remain open. Information on the battery back-up time are provided on page 666.

**Function block**

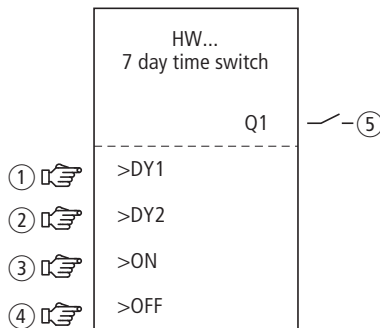

Figure 104: Seven-day time switch

- ① Parameter HW..DY1: Day 1, start of period.
- ② Parameter HW..DY2: Day 2, end of period.
- ③ Parameter HW..ON: On time.
- ④ Parameter HW..OFF: Off time.
- ⑤ Contact HW..Q1: Closes in the defined period.

### Wiring of the function block

You wire the function block in the standard circuit diagram with its contact.

Example of a 7-day time switch:

HW1 4 Q1 ----- QS0 1

Figure 105: Wiring of the function block contact

The 7-day time switch controls a device output directly.

### Parameters

When using the function block in the circuit diagram for the first time, use OK to automatically enter the general display of function block parameters, as shown in the figure on the left. Enter the function block settings here. The display contains the following elements:

```

HW1 4    A    +
  > DY1
  > DY2
  > ON
  > OFF
  
```

HW1 4	Function block: 7-day time switch, number 14
A	Time switch channel: A
+	Parameter display: Call enabled
>DY1	Day 1: Start of the period
>DY2	Day 2: End of the period
>ON	On time
>OFF	Off time

The parameters consist of the following:

**Channel**

For each week time switch channels A, B, C and D are available. These channels act jointly on contact Q1 of the week time switch.

Parameters	Function
A	Display of the parameters: Channel A
B	Display of the parameters: Channel B
C	Display of the parameters: Channel C
D	Display of the parameters: Channel D

**Parameter display**

The display of the parameters during operation can be disabled. Further information can be found in section "Parameter assignment from the standard circuit diagram" on page 161.

Parameters	Function
+	Parameters are displayed
-	Parameters are not displayed

This parameter is factory set to +.

**Day 1 and day 2**

These parameters are used to limit the period in which the output HW..Q1 is switched.

Parameters	Function
>DY1	Day 1: Day on which the output is switched on for the first time.
>DY2	Day 2: Day on which the output is switched off for the last time.

Enter either a period of several days or only of one day:

Entry	On and off time
MO	Monday
TU	Tuesday
WE	Wednesday
TH	Thursday
FR	Friday
SA	Saturday
SO	Sunday
--	No day

Examples:

```

HWI 0    A  +
  >DY1 MO
  >DY2 FR
  >ON
  >OFF
    
```

- Monday to Friday

```

HWI 4    D  +
  >DY1 MO
  >DY2 --
  >ON
  >OFF
    
```

- Only on Monday

### On and off time

Use these parameters to set the on and off time,

Parameters	Function
>ON	On time: 00:00 - 23:59 No on switching: --:--
>OFF	Off time: 00:00 - 23:59 No off switching: --:--

**Contact**

The contact of the function block is evaluated in the standard circuit diagram. It closes for the on time and opens for the off time on the defined days.

Parameters	Function
HW. . Q1	Switch contact

**Memory requirement**

The 7-day time switch function block requires 68 bytes of memory plus 4 bytes per channel used.

**Operation of the function block**

The switching points are defined according to the parameters entered.

MO to FR: on weekdays Mo, Tu, We, Th, Fr  
 ON 10:00, OFF 18:00: On and off time on each weekday.

MO: Every Monday  
 ON 10:00: On time  
 SA: Every Saturday  
 OFF 18:00: Off time

**Switching on working days**

Time switch HW01 switches on from Mondays to Fridays with channel:

- A between 6:30 and 9:30.
- B between 17:00 and 22:30.

HW01    A    + >DY1 MO >DY2 FR >ON 06: 30 >OFF 09: 30	HW01    B    + >DY1 MO >DY2 FR >ON 17: 00 >OFF 22: 30
---	---

### Switching at the weekend

Time switch HW02 switches on at 16:00 on Friday and switches off at 06:00 on Monday.

<pre> HW02    A    + &gt;DY1   FR &gt;DY2   - - &gt;ON    16: 00 &gt;OFF   - - : - - </pre>	<pre> HW02    B    + &gt;DY1   MO &gt;DY2   - - &gt;ON    - - : - - &gt;OFF   06: 00 </pre>
---	---

Figure 106: Signal diagram of "weekend"

### Overnight switching

Time switch HW03 switches on overnight at 22:00 on Monday and switches off at 06:00 on Tuesday.

<pre> HW03    D    + &gt;DY1   MO &gt;DY2   - - &gt;ON    22: 00 &gt;OFF   06: 00 </pre>
--

Figure 107: Signal diagram for night switching

**h**

If the off time is before the on time, easySafety will switch off on the following day.

**Time overlaps**

The time settings of a time switch overlap. The clock switches on at 16:00 on Monday, whereas on Tuesday and Wednesday it switches on at 10:00. On Monday to Wednesday the switching-off time is 22:00.

<pre> HW04   A   + &gt;DY1  MO &gt;DY2  WE &gt;ON   16: 00 &gt;OFF  22: 00         </pre>	<pre> HW04   B   + &gt;DY1  TU &gt;DY2  WE &gt;ON   10: 00 &gt;OFF  00: 00         </pre>
---	---

Figure 108: Signal diagram of overlaps

**h**

On and off times of output Q1 always follow the channel which switches first. In other words, the first On time at one of the four channels switches the state at output Q1 to 1.

The first Off time of a channel switches the state at output Q1 to 0.

If the On and Off times occur at the same time, output Q1 is switched off.



**Response in the event of a power failure**

The power is removed between 15:00 and 17:00. The relay drops out and remains off, even after the power returns, since the first off time was at 16:00.

HW05	A	+	HW05	B	+
>DY1	MO		>DY1	MO	
>DY2	SU		>DY2	SU	
>OFF	16:00		>ON	12:00	
			>OFF	18:00	

h

When switched on, easySafety always updates the switching state on the basis of all the available switching time settings.

**24 hour switching**

The time switch is to switch for 24 hours. Switch-on time at 00:00 on Monday and switch-off time at 00:00 on Tuesday.

HW20	A	+	HW20	B	+
>DY1	MO		>DY1	TU	
>DY2			>DY2		
>ON	00:00		>ON		
>OFF			>OFF	00:00	

**HY, year time switch**

easySafety is equipped with a real-time clock which you can use in the standard circuit diagram as a 7-day time switch and a year time switch.

**h**

The procedure for setting the time is described under section "Setting date and time" on page 584.

**Function block**

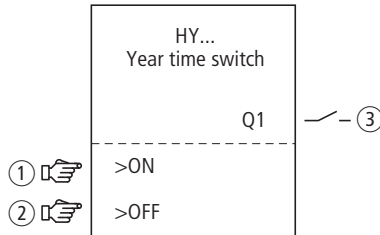

Figure 109: Year time switch function block

- ① Parameter HY..ON: On date
- ② Parameter HY..OFF: Off date
- ③ Contact HY..Q1: Closes in the defined period.

**Function**

If you have to implement special on and off switching functions on public holidays, vacations, company holidays, school holidays and special events, these can be implemented easily with the year time switch.

easySafety allows for the use of up to 16 function blocks of type "year time switch."

For each year time switch four channels A, B, C and D are available.

You can choose an on and off switching time for every channel. These channels of a year time switch all act jointly on the contact Q1 that you include in the circuit diagram. The channels are set via the parameter display or easySoft-Safety.

The year time switch can:

- Switch at recurring intervals by switching on and off for individual days, months, or years.
- Switch for continuous periods of time by remaining continuously switched on from the start of any user-defined day until the end of any user-defined day, month, or year.

h

The parameters for the switch-on and switch-off times for recurring intervals are configured in **one** single channel for each.

The parameters for the switch-on and switch-off times for a continuous period of time are configured in **two** neighbouring channels. If you enter the ON information on channel A, the OFF information must be entered on channel B; likewise, if the ON information is on channel B, the OFF information must be on channel C.

### Behaviour in the event of a power failure

The time and date are backed up in the event of a power supply failure and continue to run. This means that it will continue to run in the event of a power failure, although the time switch relays will not switch. The contacts are kept open when de-energized. Information on the battery back-up time are provided on page 666.

h

The electronic clock module integrated into the easySafety device works with a date range of 01/01/2001 to 12/31/2099

### Wiring of the function block

The function block is wired in the **standard** circuit diagram with its contact.

#### Contact

The contact closes each day for the on time and opens for the off time.

Parameters	Function
HY. . Q1	Switching contact; closes in the defined period

#### Example for a year time switch:

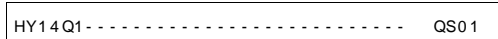

Figure 110: Wiring of the function block contact

The year time switch controls a device output directly.

### Parametric programming of the function block inputs/outputs

#### Parameters

When using the function block in the circuit diagram for the first time, use OK to automatically enter the general display of function block parameters, as shown in the figure on the left. Enter the function block settings here. The display contains the following elements:

HY14 B +  
 >ON  
 >OFF

HY14	Function block: year time switch, number 14
B	Time switch channel: B
+	Parameter display: Call enabled
>ON	On date
>OFF	Off date

The parameters consist of the following:

### Channel

For each year time switch function block, you can configure the parameters for the A, B, C, and D channels that act jointly on contact Q1 of this function block.

Parameters	Function
A	Display of the parameters: Channel A
B	Display of the parameters: Channel B
C	Display of the parameters: Channel C
D	Display of the parameters: Channel D

### Parameter display

The display of the parameters during operation can be disabled. Further information can be found in section "Parameter assignment from the standard circuit diagram" on page 161.

Parameters	Function
+	Parameters are displayed
-	Parameters are not displayed

This parameter is factory set to +.

### On and off date

Use these parameters to set the data for on and off switching in the format DD.MM.YY.

For example:

Day.Month.Year: 11.11.07

Parameters	Function
>ON	On date
>OFF	Off date

### Memory requirement

The year time switch function block requires 68 bytes of memory plus 4 bytes of memory for each channel used.

### Cycle time

mode	Cycle time [ms]
-	61

### How the function block works

The year time switch can switch ranges, individual days, months, years or combinations of all three.

```

HY01 A      +
>ON  - - . - - . 08
>OFF - - . - - . 12

```

#### Years

Switching at 00:00:

- On on 01.01.2008 and
- Off on 01.01.2013.

```

HY01 A      +
>ON  - - . 04 . - -
>OFF - - . 10 . - -

```

#### Months

Switching at 00:00:

- On on 01 April every year.
- Off on 01 November every year.

```

HY01 A      +
>ON  02 . - - . - -
>OFF 25 . - - . - -

```

#### Days

Switching at 00:00:

- On on the 2nd day of every month.
- On on the 26th day of every month.

## Entry rules

The contact switches (ON to OFF)

- in the years.
- in the defined months.
- on the entered days.

# h

### Caution!

The year time switch only operates correctly if you observe the following rules:

- The On year must be before the Off year.
- ON and OFF times must be specified the same in pairs, e.g.:
  - ON = Day/--/--, OFF = Day/--/--
  - ON = --/--/Year, OFF = --/--/Year
  - ON = --/Month/Year, OFF = --/Month/Year
  - ON = Day/month/year, OFF = Day/month/year.
- Normally, the ON day should be before the OFF day; otherwise, the exception described on Example 8 on page 265 applies.

The following nine entry rules are possible:  
(XX = position used)

```
HY01 A      +
>ON XX. . . . .
>OFF XX. . . . .
```

### Rule 1

ON: Day

OFF: Day

```
HY01 A      +
>ON  . . . XX. . .
>OFF  . . . XX. . .
```

### Rule 2

ON: Month

OFF: Month

```
HY01 A      +
>ON  . . . . . XX
>OFF  . . . . . XX
```

### Rule 3

ON: Year

OFF: Year

```

HY01 A      +
>ON XX. XX. - -
>OFF XX. XX. - -
    
```

**Rule 4**  
 ON: Day/month  
 OFF: Day/month

```

HY01 A      +
>ON - - . XX. XX
>OFF - - . XX. XX
    
```

**Rule 5**  
 ON: Month/year  
 OFF: Month/year

```

HY01 A      +
>ON XX. XX. XX
>OFF XX. XX. XX
    
```

**Rule 6**  
 ON: Day/month/year  
 OFF: Day/month/year

```

HY01 A      +
>ON XX. XX. - -
>OFF - - . - - . - -
    
```

**Rule 7**  
 Two-channel:  
 Channel A ON: Day/month

```

HY01 B      +
>ON - - . - - . - -
>OFF XX. XX. - -
    
```

Channel B OFF: Day/month

```

HY01 C      +
>ON XX. XX. XX
>OFF - - . - - . XX
    
```

**Rule 8**  
 Two-channel:  
 Channel C ON: Day/Month/Year

```

HY01 D      +
>ON - - . - - . XX
>ON - - . - - . XX
    
```

Channel D OFF: Day/month/year  
 With this rule, the same year number must be entered in each channel in the ON and OFF entry area.

**Rule 9**  
 Overlapping channels:  
 The first ON date switches on and the first OFF date switches off.

Overlapping channels:  
 The first ON date switches on and the first OFF date switches off.



## Sample parameter configurations

### Configuring the parameters for recurring intervals

#### Example 1: Selecting year range (1-channel)

The year time switch HY1 is required to switch on at 00:00 on January 1 2010 and stay on until 00:00 January 1 2012.

```
HY01 A    +
>ON  - - - - - 10
>OFF - - - - - 11
```

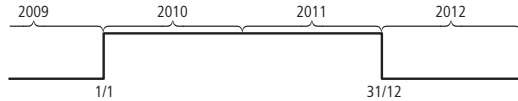

Figure 111: Select year range

#### Example 2: Selecting month ranges (1-channel)

The year time switch HY2 is required to switch on at 00:00 on March 1 and stay on until 00:00 October 1.

```
HY02 A    +
>ON  _ _ . 03 . - -
>OFF - - . 09 . - -
```

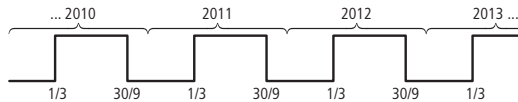

Figure 112: Select month range

#### Example 3: Selecting day ranges (1-channel)

The year time switch HY3 is required to switch on at 00:00 on day 1 of each month and switch off at 00:00 on day 29 of each month.

```
HY03 A    +
>ON  01 . - - . - -
>OFF 28 . - - . - -
```

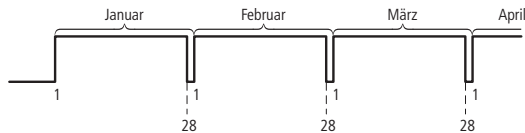

Figure 113: Select day range

```
HY04 A    +  
>ON 25. 12. - -  
>OFF 26. 12. - -
```

**Example 4: Selecting public holidays (1-channel)**

The year time switch HY04 is required to switch on at 00:00 on day 25.12 of each year and switch off at 00:00 on day 27.12 of each year. "Christmas program".

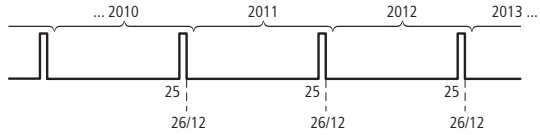

Figure 114: Select public holiday

```
HY05 A    +  
>ON 09. 06. - -  
>OFF 16. 10. - -
```

**Example 5: Specific days of specific months (1-channel)**

The year time switch HY05 is required to switch on at 0:00 on day 9 of months 6, 7, 8, 9 and 10 of each year and switch off at 00:00 on day 17 of the month.

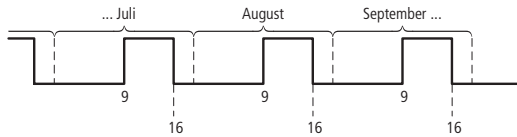

Figure 115: Chose specific days of specific months

### Configuring the parameters for continuous periods of time

The following examples show how to configure the parameters for continuous periods of time in which the time switch remains continuously switched on. The parameter definition is carried out in pairs on two adjacent channels..

#### Example 6: Time range for each year (2-channel)

The year time switch HY01 is required to switch on at 00:00 on day 02.05 of each year and stay on continuously until 00:00 on 1.11 of each year. "Open air season".

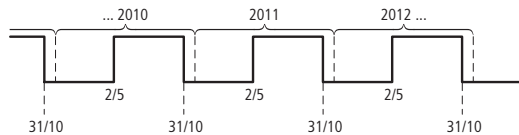

Figure 116: Select time range for each year

Parameter settings of the year time switch HY01:

```
HY01   A       +
>ON   02. 05. --
>OFF  -- . . . . --
```

ON/ OFF: First/last switch-on years are not restricted in this case.

```
HY01   B       +
>ON   -- . . . . --
>OFF  31. 10. --
```

ON/ OFF: First/last switch-off years are not restricted in this case.

**Example 7: Selecting a time range for a limited number of years (2-channel)**

The HY01 year time switch should switch on at 00:00, on 05/02, in the years 2011 and 2012, and remain switched on until 00:00 on 11/1 in each case.

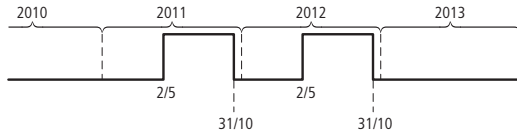

Figure 117: Select a time range for a limited number of years

Parameter settings of the year time switch HY01:

```

HY01    A      +
>ON    02. 05. 11
>OFF   - - . - - . 12

```

ON/ OFF: First/last switch-on year.

```

HY01    B      +
>ON     - - . - - . 11
>OFF   31. 10. 12

```

ON/ OFF: First/last switch-off year.

**Example 8: Selecting a time range of two days spanning the turn of the year (2-channel)**

The HY01 year time switch should switch on at 00:00 on 12/31 **of every year** and remain continuously switched on until 00:00 on 02/01 of every year.

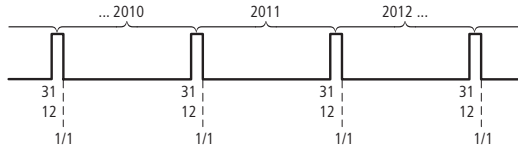

Figure 118: Select a time range of two days spanning the turn of the year

Parameter settings of the year time switch HY01:

HY01	A	+
>ON	31 . 12 . - -	
>OFF	- - . - - . - -	

ON/ OFF: First/last switch-on years are not restricted in this case.

HY01	B	+
>ON	- - . - - . - -	
>OFF	01 . 01 . - -	

ON/ OFF: First/last switch-off years are not restricted in this case.

**Example 9: Selecting a time range of two days spanning the turn of the year on 2010/2011, 2011/2012 (2-channel)**

The HY01 year time switch should switch on at 00:00 on 12/31 of 2010 and remain switched on until 00:00 on 01/02 of 2011, and switch on at 00:00 on 12/31 of 2011 and remain switched on until 00:00 on 01/02 of 2012.

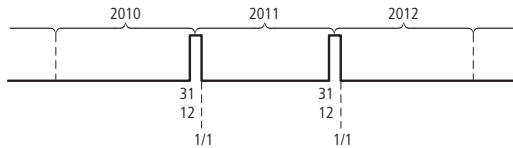

Figure 119: Select a time range of two days spanning the turn of the year

Parameter settings of the year time switch HY01:

HY01	A	+
>ON	31 . 12 . 10	
>OFF	- - . - - . 11	

ON/ OFF: First/last switch-on year.

HY01	B	+
>ON	- - . - - . 11	
>OFF	01 . 01 . 12	

ON/ OFF: First/last switch-off year.

**Example 10: Overlapping time ranges (2-channel)**

This example shows how to configure the parameters for continuous overlapping time ranges on adjacent channels.

The HY01 year time switch, **channel C**, switches on at 00:00 on the third of months 5, 6, 7, 8, 9, 10 and remains switched on until 00:00 on the 26th of these months.

The HY01 year time switch, **channel D**, switches on at 00:00 on the second of months 6, 7, 8, 9, 10, 11, 12 and remains switched on until 00:00 on the 18th of these months.

Parameter settings of the year time switch HY01:

```

HY01   C       +
>ON   03. 05. - -
>OFF  25. 10. - -

```

```

HY01   D       +
>ON   02. 06. - -
>OFF  17. 12. - -

```

Total result corresponding to the channel configurations and behaviour of contact Q1 in this example:

The time switch switches on at 00:00 on 3 May and stays on until 00:00 on 26 May.

In June, July, August, September, October, the time switch will switch on at 00:00 on day 2 of the month and switch off at 00:00 on day 18.

In November and December, the time switch will switch on at 00:00 on the second of the month and switch off until 00:00 on the 18th. The following note explains this switching behaviour.

**h**

Switching behaviour of channels parameterized with overlaps:

If parameterised ranges overlap, the year time switch switches the contact on with the first detected ON, irrespective of which channel supplies this ON signal. In the same way, the year time switch switches the contact off with the first detected OFF, irrespective of whether another channel still supplies the ON signal.

**JC, conditional jump**

With function block JC.. you can branch off forwards to a jump label LB within the function block list to skip several function blocks. You use LB.. (jump label) as the jump destination. The JC and LB function blocks are used in the standard circuit diagram.

easySafety allows up to 16 conditional jumps.

h

An LB function block must be entered for each JC function block. You must use the JC.. and LB.. function blocks in pairs. The jump label LB01 must thus always be used with conditional jump function block JC01.

h

The description of the LB jump label function block is provided from page 272.

**Function block**

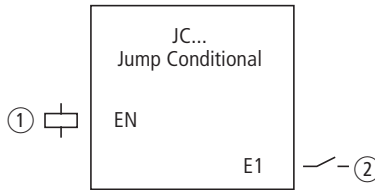

Figure 120: Conditional jump function block

- ① Coil JC..EN: Enables the operation of the function block.
- ② Contact JC..E1: Error message

**Wiring of the function block**

You wire the function block in the standard circuit diagram with its enable coil JC..EN. It can be wired directly to the device terminals IS1 to IS14 or associated internally.

Example of a conditional jump:

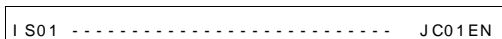

Figure 121: Wiring the enable coil



J C0 1	+
--------	---

### Parameters

When using the function block in the circuit diagram for the first time, use OK to automatically enter the general display of function block parameters, as shown in the figure on the left. Enter the function block settings here. The display contains the following elements:

J C0 1	Function block: Conditional jump, number 01
+	Without function

### Coil

The coil of the function block is used in the standard circuit diagram to activate the function block.

Parameters	Function
J.C. . EN	Selective activation of the function block

### Contact

The contact of the function block is evaluated in the standard circuit diagram. It indicates a fault if there is not an associated jump present or is in front of the jump location (backward jump).

Parameters	Function
J.C. . E1	Fault signal

### Memory requirement

The conditional jump function block requires 20 bytes of memory.

### Operation of the function block

If the JC..EN enable coil is active, the program jumps forwards over one or several function blocks. The next function block to be processed is the first to follow the LB jump label in the function block diagram. If the JC..EN enable coil is not active, the program is processing the next function block that is added in the function block diagram behind JC...

In the function block list a jump label must be positioned downstream, i.e. towards the end of the list when viewed from associated function block "conditional jump". If it is placed in front of the associated jump location (backward jump), the program branches to the end of the function block list and fault contact JC..E1 of function block "conditional jump" closes. If no associated jump label is set in the function block list, the program jumps to the end of the list. This also skips the last rung and fault contact JC..E1 also closes.

### Example

A jump is to be made downstream of a table function block when marker M01 has the state 1.

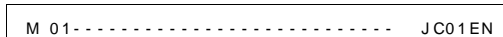

Figure 122: Example of conditional jump

J C 0 1	+
T B 0 1	-
L B 0 1	
L: 0 3 1	B: 6 4 8 8

Enter the function block editor via STANDARD -> PROGRAM -> FUNCTION RELAYS.

- X In this menu use the cursor buttons to move to the location from where the jump is to be made and press OK.
- X Then use the cursor keys to select function block JC01 and close the input dialog with two clicks on OK.
- X Insert table function block TB01 into then next position in the function block list, configure it and complete your input with ESC.
- X Use the cursor keys to navigate to the next position in the function block list and insert the jump label LB01 described below there.

During processing the program branches off to jump label LB01 as long as JC01EN remains in state 1.

**h**

For subsequently inserting function block JC.. in the function block list to skip other, existing function blocks, the use of the easySoft Safety configuration software is recommended. This software allows function blocks to be moved into any position.

**LB, jump label**

Within the function block list jump label LB.. is the jump target for a conditional jump with function block JC.. In the standard circuit diagram function blocks JC and LB are always used in pairs.

easySafety allows the use of up to 16 jump labels.

**Function block**

Because function block LB.. acts only as a jump target, it does not have to be linked in the circuit diagram and does not have to be parameterized. It has neither coils nor contacts and is simply placed at the required position in the function block list.

h

For each function block LB.. a corresponding function block JC.. (conditional jump) must exist as jumping-off point. Conditional jump JC01, for example, is always associated with jump label LB01.

In the function block list a jump label must be positioned downstream, i.e. towards the end of the list when viewed from associated function block "conditional jump". If it is placed in front of the associated jump location (backward jump), the program branches to the end of the function block list and fault contact JC..E1 of function block "conditional jump" closes. If no associated jump label is set in the function block list, the program jumps to the end of the list and fault contact JC..E1 also closes.

Enter the function block editor from the main menu via STANDARD -> PROGRAM -> FUNCTION RELAYS.

- x In this menu use the cursor buttons to move to the location to which the jump is to be made and press OK.
- x Then use the cursor keys to select function block LB.. and close the input dialog with two clicks on OK.

The description of the JC function block, conditional jump, is provided from a chapter "JC, conditional jump" on page 268. This also contains an example.

**MR, master reset**

The master reset function block allows you to reset the states of the markers and all outputs to 0 with a single command. The mode of the function block allows you to set whether only the outputs, only the markers or outputs and markers are to be reset.

easySafety allows the use of up to 16 master reset function blocks.

**Function block**

Figure 123: Master reset function block

- ① Coil MR..T\_: Trigger coil, function block resets on rising edge.
- ② Contact MR..Q1: Closes on reset.

**Wiring of the function block**

You wire the function block in the standard circuit diagram with its trigger coil.

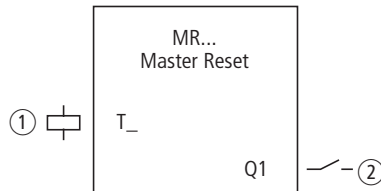
Example of a master reset function block:

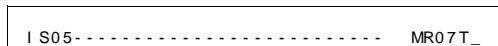

Figure 124: Wiring the trigger coil

The trigger coil is connected to a device input.

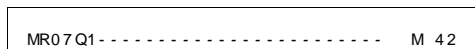
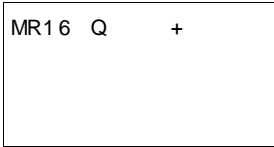

Figure 125: Wiring the contacts

The message of the function block is sent to a marker.



**Parameters**

When using the function block in the circuit diagram for the first time, use OK to automatically enter the general display of function block parameters, as shown in the figure on the left. Enter the function block settings here. The display contains the following elements:

MR16	Function block: Master reset, number 16
Q	Mode: Reset outputs
+	Parameter display: Call enabled

The parameters consist of the following:

**Operating mode**

The mode setting allows you to set whether markers, outputs or both are to be reset.

Parameters	Function
Q	Resets the outputs used in the standard circuit diagram, S., *S., *SN.; * = NET-ID
M	Acts on the marker range MD01 to MD96.
ALL	Acts on the operands specified above under Q and M that are used in the standard circuit diagram.

This parameter is factory set to Q.

**Parameter display**

The display of the parameters during operation can be disabled. Further information can be found in section “Parameter assignment from the standard circuit diagram” on page 161.

Parameters	Function
+	Parameters are displayed
-	Parameters are not displayed

This parameter is factory set to +.

**Coil**

The coil of the function block is used in the standard circuit diagram.

Parameters	Function
MR..T_	Triggering the function on a rising edge

**Contact**

The contact of the function block is evaluated in the standard circuit diagram. A closed contact indicates:

Parameters	Function
MR..Q1	Reset

**Memory requirement**

The master reset function block requires 20 bytes of memory.

**Operation of the function block**

All outputs or the markers are set to 0 in accordance with the operating mode when a rising edge is detected on the trigger coil.

**h**

Carry out the master reset function block so that all data ranges are cleared reliably. Otherwise subsequent function blocks may overwrite the data ranges.

The contact MR1..Q1 assumes the state of its own trigger coil and confirms the reset operation.

**MX, data multiplexer**

The data multiplexer function block allows you to select a value from eight input values MX..I1 to MX..I8 as if using a mode selector switch. The function block provides this value after transferring it to its output MX..QV.

easySafety allows the use of up to 16 data multiplexers.

**Function block**

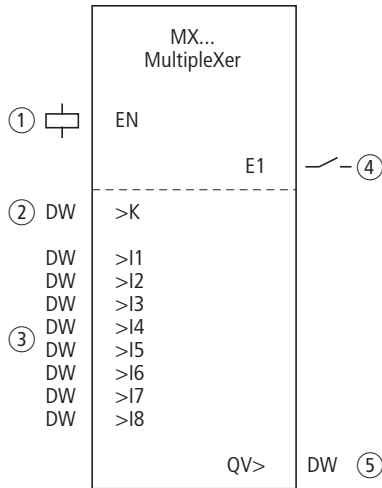

Figure 126: Data multiplexer function block

- ① Coil MX..EN: Enables the operation of the function block.
- ② Input MX..K: Sets the channel number.
- ③ Inputs MX..I1 to MX..I8: Input channels I1 to I8.
- ④ Contact MX..E1: Closes if an invalid channel was set.
- ⑤ Output MX..QV: Supplies the selected input value.



### Wiring of the function block

In the standard circuit diagram the function block is enabled and its fault output scanned.

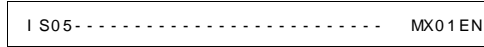

Figure 127: Wiring the enable coil

Its coil MX01EN is directly connected to the device terminal IS05.

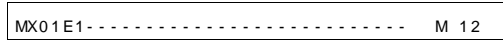

Figure 128: Wiring of the function block contact MX01E1

The function block contact MX01E1 (fault message) is associated with the marker M12.

### Parameters

When using the function block in the circuit diagram for the first time, press OK to enter the general display of the function block parameters automatically, as shown in the figure on the left for an on-delayed timing relay. Enter the function block settings here. The display contains the following elements:

```

MX0 1      +
>K
>I 1
>I 2

>I 3
>I 4
>I 5
>I 6
>I 7
>I 8
QV>

```

MX0 1	Function block; Data multiplexer, number 01
+	Parameter display: Call enabled
>K	Channel number (0 - 7)
>I 1	Input channel 1 - 8
>I 8	
QV>	Output

The parameters consist of the following:

**Parameter display**

The display of the parameters during operation can be disabled. Further information can be found in section "Parameter assignment from the standard circuit diagram" on page 161.

Parameters	Function
+	Parameters are displayed
-	Parameters are not displayed

This parameter is factory set to +.

**Inputs**

Function block input >K is used to define the input channel to be supplied at function block output QV>.

Assign the values to function block inputs >I1 to >I8 that you wish to output on function block output QV>.

Parameters	Function
>K	Channel number (0 - 7)
>I 1..>I 8	Input value 1-8: - 2147483648 - +2147483647

The function block inputs >K and >I1 and >I8 can have the following operands:

- Constant.
- Markers MD, MW, MB.
- Output ...QV> of a different function block.

### Output

The output QV> supplies the value present at the selected input channel.

Parameters	Function, parameterisation in the function block
qV>	Output value: - 2147483648 - +2147483647

The function block output MX..QV can have the following operands:

- Markers MD, MW, MB.

### Coil

The coil MX..EN is used to activate the function block in the standard circuit diagram.

Coil	Function
MX. . EN	Activation of the function block

### Contact

The contact of the function block is evaluated in the standard circuit diagram. A closed contact indicates:

Parameters	Function
MX. . E1	Fault, e.g. invalid parameter

### Memory requirement

The data multiplexer function block requires 96 bytes of memory plus 4 bytes per constant at the function block inputs.

**Operation of the function block**

The multiplexer is active if the enable coil MX..EN has been triggered.

You use the channel number input MX..K to set which input is to be switched through to the output. The channel number input switches the input values in their order, i.e.:

- Channel number 0 supplies the input MX..I1 to MX..QV.
- Channel number 7 supplies the input MX..I8 to MX..QV.

The fault contact MX..E1 closes if an invalid parameter is present at the channel number input MX..K.

**Example**

A drive is required to run at a fixed speed and at three dependent speeds.

It receives the setting from a multiplexer function block.

MB08 defines the channel number that is to be passed onto the output. The fixed speed is set as a constant at input MX01I1, the subsequent inputs are assigned the variable values from markers MB01 to B03. The setpoints at output MX01QV of the function block are output at MB04.

The function block is first of all activated in the standard circuit diagram by marker M33. The following diagram shows the association.

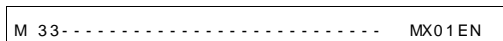

Figure 129: Circuit diagram for enabling the data multiplexer function block

```
MX01      +  
>K  MB08  
>I 1  +40  
>I 2  MB01
```

```
>I 3  MB02  
>I 4  MB03  
>I 5  
>I 6  
>I 7  
>I 8  
QV>  MB04
```

Enter the parameters of the function block as shown on the left.

**NC, numerical converter**

The numerical converter function block is used to convert a value:

- BCD to a binary value
- Binary value to BCD.

The binary value is further processed in the device. For example it can be added to a value. The binary value is displayed in the simulator as a decimal value.

easySafety allows the use of up to 16 numerical converters.

**Function block**

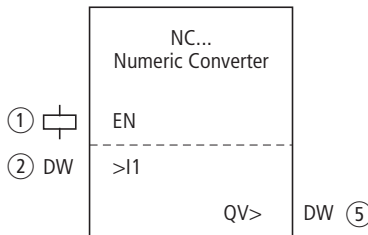

Figure 130: Numerical converter function block

- ① Coil NC..EN: Enables the operation of the function block.
- ② Input NC..I1: Input value.
- ③ Output NC..QV: Supplies the converted input value.

**Wiring of the function block**

The function block is enabled in the standard circuit diagram. For example:

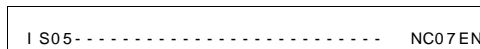

Figure 131: Wiring the enable coil

Its coil NC..EN is directly connected to the device terminal IS5.

NC02	BCD	+
>I 1		
QV>		

## Parameters

NC02	Function block; Numerical converter, number 02
BCD	Mode: Converting BCD to binary
+	Parameter display: Call enabled
>I 1	Input value
QV>	Output value

The parameters consist of the following:

### Operating mode

The mode determines whether a binary value is to be converted to BCD or vice versa.

Parameters	Function, parameterisation in the function block
BCD	Converting BCD to binary
BI N	Converting binary to BCD

The factory setting of this parameter is BCD.

### Parameter display

The display of the parameters during operation can be disabled. Further information can be found in section "Parameter assignment from the standard circuit diagram" on page 161.

Parameters	Function
+	Parameters are displayed
-	Parameters are not displayed

This parameter is factory set to +.

**Number range of the BCD code**

The BCD code only allows the number range 0 to 9. Values greater than 9 are processed as 9.

BCD code	Decimal value
0000	0
0001	1
0010	2
0011	3
0100	4
0101	5
0110	6
0111	7
1000	8
1001	9
1010 - 1111	Not permissible
0001 0000	10
1001 1001	99

**Input**

Assign the input value to be converted to function block input >I1.

Parameters	Function
>I 1	Input value: Decimal: -161061273 - +161061273 BCD: -9999999 - +9999999

The function block input >I1 knows the following operands:

- Constant.
- Markers MD, MW, MB.
- Output ...QV> of a different function block.



## Output

Output QV> supplies the converted value.

Parameters	Function, parameterisation in the function block
QV>	Output value: Decimal: -161061273 - +161061273 BCD: -9999999 - +9999999

The function block register output NC..QV can have the following operands:

- Markers MD, MW, MB.

## Coil

The coil NC..EN is used to activate the function block in the standard circuit diagram. If coil NC..EN is not active, the entire function block is deactivated and reset. The output value is set to zero.

Coil	Function
NC. . EN	Selective activation of the function block

## Memory requirement

The numerical converter function block requires 32 bytes of memory plus 4 bytes per constant at the function block input.

## Operation of the function block

### BCD mode

The BCD value present at input I1 is converted to a binary value and supplied on the output QV>. The binary value is displayed as a decimal value.

Example 1:

Input value >I1: +9<sub>dec</sub>

Binary value: 1001

Decimal value QV>: + 9

Example 2:  
 Input value >I1: +14<sub>dec</sub>  
 Binary value: 1110  
 Decimal value QV>: + 9

Example 3:  
 Input value >I1: 19<sub>dec</sub>  
 Binary value: 00010011  
 Decimal value QV>: 13

Example 4:  
 Input value >I1: 161061273<sub>dec</sub>  
 Binary value: 1001100110011001100110011001  
 Decimal value QV>: 9999999

Example 5:  
 Input value >I1: -61673<sub>dec</sub>  
 Binary value: 10000000000000001111000011101001  
 Decimal value QV>: -9099

**h** Bit 32 is the sign bit. Bit 32 = 1 r Sign = Minus.

Example 6:  
 Input value >I1: 2147483647<sub>dec</sub>  
 Binary value: 01111111111111111111111111111111  
 Decimal value QV>: 9999999

**h** Values greater than 161061273 are output as 9999999.  
 Values less than -161061273 are output as -9999999.  
 The working range of the function block has been exceeded.

**BIN mode**

The binary value present at input >I1 is converted to a BCD value and supplied at the output QV>. The binary value is displayed as a decimal value.

Example 1:

Input value >I1:  $+7_{\text{dec}}$   
 BCD binary value: 0111  
 Hexadecimal value: 0111  
 Decimal value QV>: + 7

Example 2:

Input value >I1:  $+11_{\text{dec}}$   
 BCD binary value: 0001 0001  
 Hexadecimal value: 0001 0001  
 Decimal value QV>: +17 (1 + 16)

Hexadecimal value:  
 Bit 0 has the value 1.  
 Bit 4 has the value 16  
 Total: Bit 0 plus bit 4 = 17

Example 3:

Input value >I1:  $19_{\text{dec}}$   
 BCD binary value: 0001 1001  
 Hexadecimal value: 0001 1001  
 Decimal value QV>: 25 (1 + 8 + 16)

Example 4:

Input value >I1:  $9999999_{\text{dec}}$   
 BCD binary value: 1001100110011001100110011001  
 Hexadecimal value: 1001100110011001100110011001  
 Decimal value QV>: + 161061273

Example 5:

Input value >I1: -61673<sub>dec</sub>

BCD binary value: 10000000000001100001011001110011

Hexadecimal value:

10000000000001100001011001110011

Decimal value QV>: + -398963

h

Bit 32 is the sign bit. Bit 32 = 1 r Sign = Minus.

Example 6:

Input value >I1: 2147483647<sub>dec</sub>

BCD binary value: 01111111111111111111111111111111

Hexadecimal value:

01111111111111111111111111111111

Decimal value QV>: + 161061273

h

Values greater than 9999999 are output as 161061273.  
Values less than -9999999 are output as -161061273.  
The working range of the function block has been exceeded.

## OT, operating hours counter

The function block is used to record the operating hours of independent events or states. The status of the operating hours counter is also retained when in a de-energized state. As soon as the enable coil of the function block is active, the easySafety counts the hours in minutes, although the display only shows hours.

easySafety allows the use of up to 4 operating hours counters.

### Function block

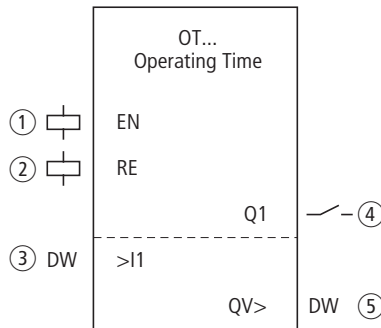

Figure 132: Operating hours counter function block

- ① Coil OT..EN: Enables the operation of the function block.
- ② Coil OT..RE: Resets the actual value to 0.
- ③ Input OT..I1: Sets the upper limit setpoint.
- ④ Contact OT..Q1: Closes on reaching or exceeding the upper limit setpoint.
- ⑤ Output OT..QV: Outputs the current counter value.

### Wiring of the function block

You wire the function block in the standard circuit diagram with its coils and contact.

Example of an operating hours counter:

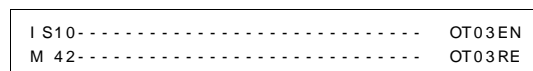

Figure 133: Wiring the function block coils

The enable coil of the function block is connected here directly to the device inputs. A marker activates the reset coil.

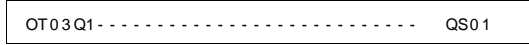
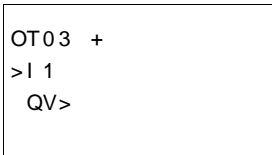

Figure 134: Wiring of the function block contact

The message of the function block was wired to a device output.

**Parameters**

When using the function block in the circuit diagram for the first time, use OK to automatically enter the general display of function block parameters, as shown in the figure on the left. Enter the function block settings here. The display contains the following elements:



OT 03	Function block: Operating hours, number 03
+	Parameter display: Call enabled
>I 1	Upper setpoint in hours
QV>	Actual value of the operating hours counter

The parameters consist of the following:

**Parameter display**

The display of the parameters during operation can be disabled. Further information can be found in section "Parameter assignment from the standard circuit diagram" on page 161.

Parameters	Function
+	Parameters are displayed
-	Parameters are not displayed

This parameter is factory set to +.

### Input

The >I1 block input is used to specify the upper setpoint value in hours. When it is reached, the block contact sends a signal.

Parameters	Function
>I 1	Upper setpoint: 0 hours - > 100 years

The function block input >I1 can be assigned the following operands:

- Constant.
- Markers MD, MW, MB.
- Output ...QV> of a different function block.

### Output

The output QV> supplies the counted operating hours as an integer value in hours.

Parameters	Function
QV>	Operating hours: 0 hours - > 100 years

You can assign the following operands to output ...QV>:

- Markers MD, MW, MB

### Coils

The enable coil starts the function block.

The reset coil resets the operating hours counter to zero.

Parameters	Function
OT . . EN	Selective activation of the function block
OT . . RE	Reset the counter to zero

**Contact**

The contact of the function block is evaluated in the standard circuit diagram. A closed contact indicates:

Parameters	Function
OT...Q1	Reaching or exceeding the upper limit setpoint

**Memory requirement**

The operating hours counter function block requires 36 bytes of memory plus 4 bytes per constant at the function block input.

**Operation of the function block**

If the enable coil OT...EN is triggered to the 1 state, the counter adds the value 1 to its actual value every minute (basic clock rate: 1 minute).

If the actual value on QV> reaches the setpoint value of >I1, the contact OT...Q1 switches for as long as the actual value is greater than or equal to the setpoint value.

The actual value is retained in the unit until the reset coil OT...RE is actuated. The actual value is then set to zero.

h

The following operations do not clear the actual value of the operating hours counter: Operating mode change RUN, STOP, power ON, OFF, Delete program, Change program, Load new program.

**Accuracy**

The operating hours counter is accurate to the nearest minute. If the enable coil signal is terminated within a minute, the value for seconds is lost.

The value range of the operating hours counter is between 0 hours and 100 years.



**PT - Put value to the NET**

The PUT function block PT.. enables you to transfer a 32-bit operand to the NET. This value can be transferred to the standard circuit diagram.

The operand value is transferred and automatically read by the corresponding GET function block GT of another NET station.

easySafety allows the use of up to 16 PUT function blocks.

**Function block**

Figure 135: PUT function block

- ① Coil PT..T\_: Trigger coil, on a rising edge the function block temporarily stores the input value and transfers it to the NET.
- ② Input PT..I1: The value that is to be put onto the NET.
- ③ Contact PT..Q1: Closes while the trigger coil is active.
- ④ Contact PT..AC: Closes during the buffering of the input value and its subsequent transfer to the network.
- ⑤ Contact PT..E1: Closes in the event of a transfer fault.

**Wiring of the function block**

You wire the function block in the standard circuit diagram with its trigger coil and its contacts.

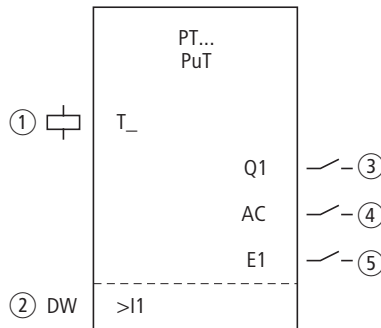
Example of a PUT function block:

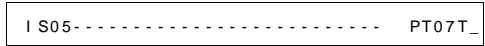

Figure 136: Wiring the trigger coil

The trigger coil is connected to a device input.

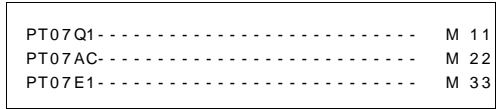
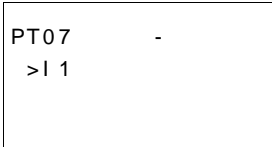

Figure 137: Wiring the function block contacts

The contacts transfer the function block information to markers.

**Parameters**

When using the function block in the circuit diagram for the first time, use OK to automatically enter the general display of function block parameters, as shown in the figure on the left. Enter the function block settings here. The display contains the following elements:



PT07	Function block: PUT, number 07
-	Parameter display: Call not enabled
>I 1	Input value that is to be put onto the NET

The parameters consist of the following:

### Parameter display

The display of the parameters during operation can be disabled. Further information can be found in section "Parameter assignment from the standard circuit diagram" on page 161.

Parameters	Function
+	Parameters are displayed
-	Parameters are not displayed

This parameter is factory set to +.

### Input

When the function block is triggered, the value present at function block input >I1 is temporarily stored and then transferred to the NET.

Parameters	Function
>I 1	Input value: -2147483648 - +2147483647

The function block input can be assigned the following operands:

- Constant.
- Markers MD, MW, MB.
- Output ...QV> of a different function block.

**Coil**

The trigger coil of the function block is used in the standard circuit diagram. On activation the function block temporarily stores the input value and transfers it to the NET.

Parameters	Function
PT. . T_	Trigger coil

**Contacts**

The contacts of the function block are evaluated in the standard circuit diagram. A closed contact indicates:

Parameters	Function
PT. . Q1	The trigger coil is active.
PT. . AC	The temporary storage and subsequent transfer of the input value to the NET.
PT. . E1	A transfer error.

**Memory requirement**

The PUT function block requires 36 bytes of memory plus 4 bytes per constant at the function block input.

**PUT diagnostics**

The PUT function block only functions if the NET is running properly (a section "Checking the functionality of the NET", page 543).

### Operation of the function block

When the trigger coil PT..T\_ picks up, the contact PT..Q1 and stays closed for as long as the trigger coil remains activated.

The activation triggers the temporary storage of the input value present at input >I1. The function block then transfers this value to the easyNet network. The function block contact PT..Q1 closes during this time.

If the temporarily stored value is not sent, the contact PT..E1 closes and therefore indicates a transfer error. It stays closed until the trigger coil PT..T\_ picks up to issue a new send job.

The signal diagram shows the relationship of the send job and its triggering by the trigger coil:

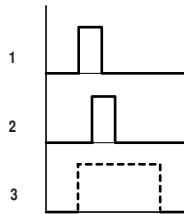

Figure 138: Signal diagram of PUT function block

- 1: Trigger coil
- 2: trigger coil contact feedback
- 3: Send

**SC, set date/time**

This function block allows you to selectively place the date and time onto the NET. All other stations accept the date and time of the sending station. This value can be used in the standard circuit diagram.

easySafety allows the use of one set date/time function block.

**Function block**

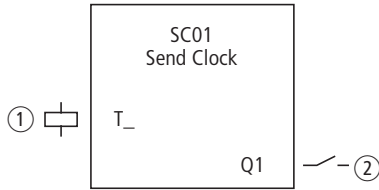

Figure 139: Set date/time function block

- ① Coil SC01T\_: Trigger coil, when activated, the function block transfers date and time of the sender to the NET.
- ② Contact SC01Q1: Closes while the trigger coil is active.

**Wiring of the function block**

You wire the function block in the standard circuit diagram with its trigger coil and its contact.

Example of a set date/time function block:

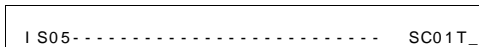

Figure 140: Wiring the trigger coil

The trigger coil is connected to a device input.

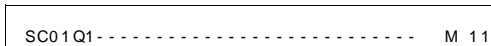

Figure 141: Wiring of the function block contact

The contact is assigned to a marker.

**Parameters**

This function block is a triggerable system service. It therefore does not have any parameters.

**Coil**

The trigger coil of the function block is used in the standard circuit diagram.

Parameters	Function
SC01T_	Trigger coil

**Contact**

The contact of the function block is evaluated in the standard circuit diagram. A closed contact indicates:

Parameters	Function
SC01Q1	while the trigger coil is active.

**Memory requirement**

The SC function block requires 20 bytes of memory.

**SC diagnostics**

The SC function block only functions if the NET is running properly (a section "Checking the functionality of the NET", page 543).

**Operation of the function block**

If the trigger coil of the function block is activated, the current date, the day of the week and time from the sending station is automatically put onto the NET. The sending stations executes this operation as soon as a new minute starts on the device real-time clock. The other stations accept this value.

Example: The trigger pulse is actuated at 03:32:21 (hh:mm:ss). The other stations are synchronised at 03:33:00. This time is accessed by all other stations. This process can be repeated as often as desired.

**Accuracy of time synchronisation**

The maximum time deviation between the functional stations is 5 s.

**SR, shift register**

The shift register function block enables you to move bits or marker double words one position forwards or backwards with every clock pulse, depending on whether Bit or Double word (DW) mode is selected. The shift register has a linear structure. If, for example, a bit is added at one end of the shift register in a bit operation with a clock pulse, a bit will be pushed out at the other end. You can choose between two operating modes:

- Bit (BIT).
- Double word (DW).

easySafety allows the use of up to 16 shift registers.

**Function block**

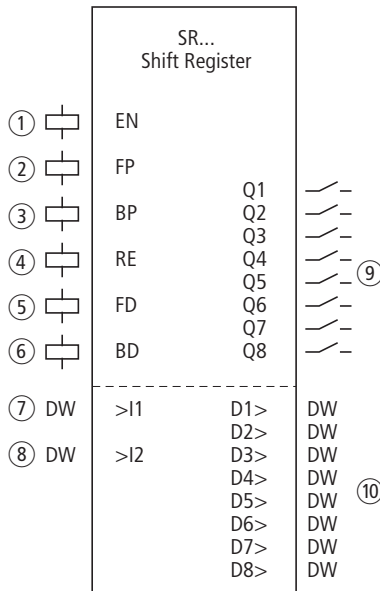

Figure 142: Shift register function block

- ① Coil SR..EN: Enables the operation of the function block.
- ② Coil SR..FP: Clock pulse forwards.
- ③ Coil SR..BP: Clock pulse backwards.
- ④ Coil SR..RE: Resets the shift register to zero.



- ⑤ Coil SR..FD: Data bit forwards.
- ⑥ Coil SR..BD: Data bit backwards.
- ⑦ Input SR..I1: Input value forwards.
- ⑧ Input SR..I2: Input value backwards.
- ⑨ Contact SR..Q1 to SR..Q8: Close, as long as your register values are 1.
- ⑩ Outputs SR..D1 to SR..D8: Register values 1 to 8 of the shift register.

### Wiring of the function block

In BIT mode you integrate the shift register function block in the standard circuit diagram with its coils and contacts:

M 10	-----	SR01EN
M 11	-----	SR01FD
M 12	-----	SR01FP
M 13	-----	SR01BD
M 14	-----	SR01BP
M 15	-----	SR01RE

Figure 143: BIT mode, wiring the function block coils

The function block coils are switched by markers.

SR01Q1	-----	M1
SR01Q2	-----	M2
SR01Q3	-----	M3
SR01Q4	-----	M4
SR01Q5	-----	M5
SR01Q6	-----	M6
SR01Q7	-----	M7
SR01Q8	-----	M8

Figure 144: BIT mode, wiring the function block contacts

The contacts of the function block are connected with markers.

In DW mode you only integrate the coils in the standard circuit diagram:

M 05	-----	SR01EN
M 06	-----	SR01FP
M 07	-----	SR01BP
M 08	-----	SR01RE

Figure 145: DW mode, wiring the function block contacts

You assign parameters to inputs and outputs in the function block diagram.

**Parameters**

When using the function block in the circuit diagram for the first time, use OK to automatically enter the general display of function block parameters, as shown in the figure on the left. Enter the function block settings here.

The parameter display is the same for both operating modes and only the parameter for data format is different.

**Operating mode**

With this parameter you define whether you wish to run the shift register as a bit register or in double word format.

Parameters	Function, parameterisation in the function block
BI T	Bit operation
DW	Double word operation

The factory setting of this parameter is BIT.

SR01	BI T	+
>I 1		
>I 2		
D1>		
D2>		
D3>		
D4>		
D5>		
D6>		
D7>		
D8>		

- BIT mode

The function block must be included in the program. Once selected, the parameter block appears, as shown on the left. In this operating mode, the data bit is transferred to the SR..FS input coil to be shifted forward and to SR..BD to be shifted backward.

h

The displayed inputs/outputs of the function block I1, I2 D1-D8 have no function in BIT mode! If they are assigned operands, these will have no effect. The wiring of the SR function block (BIT) is carried out in the circuit diagram.

SR01	DW	+
>I 1		
>I 2		
D1>		
D2>		
D3>		
D4>		
D5>		
D6>		
D7>		
D8>		

- DW mode

SR01	Function block: SR shift register, number 01
DW	Mode: Double word marker operation
+	Appears in the parameter display
>I 1	Input value forwards
>I 2	Input value backwards
D1>	Register value 1
D2>	Register value 2
D3>	Register value 3
D4>	Register value 4
D5>	Register value 5
D6>	Register value 6
D7>	Register value 7
D8>	Register value 8

The parameters consist of the following:

**Parameter display**

The display of the parameters during operation can be disabled. Further information can be found in section "Parameter assignment from the standard circuit diagram" on page 161.

Parameters	Function
+	Parameters are displayed
-	Parameters are not displayed

This parameter is factory set to +.

**Inputs**

In DW mode you assign function block inputs >I1 and >I2 with the values that are to be read into the shift register.

Parameters	Function
>I 1	Input value forwards: -2147483648 - +2147483647
>I 2	Input value backwards: -2147483648 - +2147483647

The inputs can have the following operands:

- Constant.
- Markers MD, MW, MB.
- Output ...QV> of a different function block.

## Outputs

Likewise, only in DW mode do the function block outputs D1> to D8> output register values 1 to 8.

Parameters	Function
D1> .. D8>	Register values 1 - 8: -2147483648 - +2147483647

The outputs can have the following operands:

- Markers MD, MW, MB.

## Coils

The coil SR..EN is used to activate the function block in the standard circuit diagram.

Coil	Function
SR. . EN	Selective activation of the function block

The forwards pulse input coil SR..FP triggers the following function when it is activated, depending on the mode:

Coil	Function
SR. . FP	BIT mode: Transfer of the data bit at input coil SR..FD to the register SR..Q1. DW mode: Transfer of the value SR..I1 to the register SR..D1.

The remaining content of the register is then moved forwards.

The backwards pulse input coil SR..BP triggers the following function when it is activated, depending on the mode:

Coil	Function
SR. . BP	BIT mode: Transfer of the data bit at input coil SR..BD to the register SR..Q8. DW mode: Transfer of the value SR..I2 to the register SR..D8.

The remaining content of the register is then moved backwards.

The reset coil SR..RE causes the following in both directions:

Coil	Function
SR. . RE	Reset of the register

**Contacts**

For the standard circuit diagram the function block in BIT mode has 8 contacts SR..Q1 to SR..Q8. A closed contact indicates:

Coil	Function
SR. . Q1 - SR. . Q8	Output of the bit register fields 1 - 8

**Memory requirement**

The SR function block requires 96 bytes of memory plus 4 bytes per constant at the function block input.

## Operation of the function block

h

The shift register function block must be enabled so that it can work, i.e. the coil SR..EN must be active. If this is not active, the entire function block is deactivated.

The shift register has a linear structure. This means that a clock pulse initiates the following actions:

- A new value/data bit is transferred to the register and the other data is moved one place further in the register.
- The value/data bit at the other end of the register is pushed out.
- Both shift directions, forwards and backwards, are possible.

The function block has two operating modes for different data formats:

- BIT for a bit data format
- DW for a double word data format.

In BIT mode, the function block uses

- Input coils: SR..FD and SR..BD.
- Register field contacts: SR..Q1 to SR..Q8.

In DW mode the function block processes inputs and outputs in double word format:

- Inputs SR..I1 and SR..I2
- Outputs: SR..D1 to SR..D8.

SR..FD and SR..I1 are for data that the function block transfers to register Q1 or D1 in a forwards direction when SR..FP is activated.

The following two figures illustrate the process for forward shift operations in BIT and DW modes.

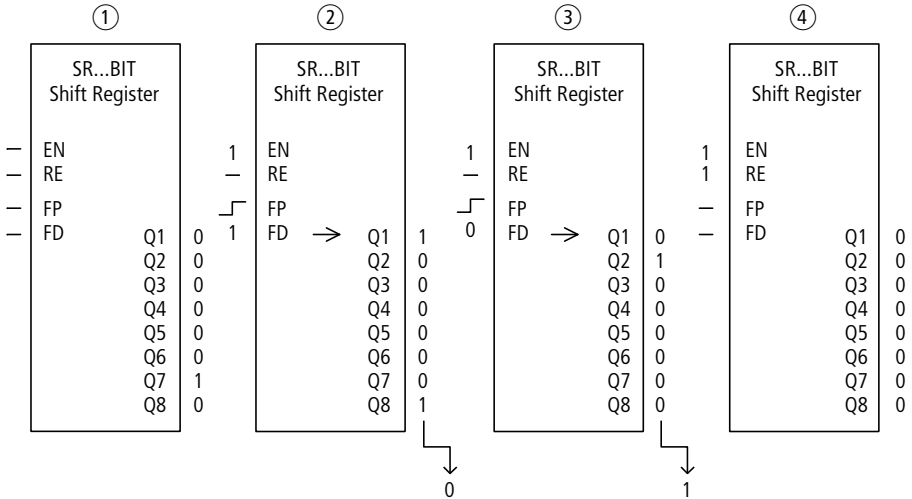

Figure 146: Shift register SR...: Forwards operation in BIT mode

- ① Initial situation
  - SR..EN is not activated, the function block is not active.
  - SR..Q7 contains a data bit 1, a 0 is contained in the other register fields.
- ② Transfer of a data bit:
  - SR..EN is activated, the function block is active.
  - SR..FD has data bit 1.
  - With the forwards pulse from SR..FP the register field SR..Q1 shifts the content of all register fields one place forwards and accepts the 1 from SR..FD.
- ③ Transfer of a data bit:
  - SR..EN is activated, the function block is active.
  - SR..FD has data bit 0.
  - with the forwards pulse from SR..FP the register field SR..Q1 shifts the content of all register fields one place forwards and accepts the 0 from SR..FD.
- ④ Reset of the register:
  - SR..EN is activated, the function block is active.
  - Activating SR..RE clears the content of the register.



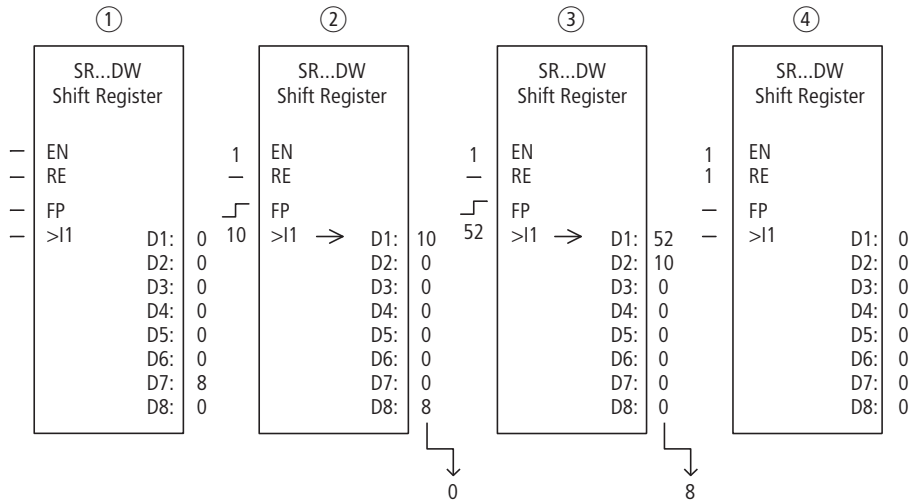

Figure 147: Shift register SR.: Forwards operation in DW mode

- Initial situation:
  - SR..EN is not activated, the function block is not active.
  - SR..D7 contains the value 8, a 0 is contained in the other register fields.
- Transfer of value:
  - SR..EN is activated, the function block is active.
  - SR..I1 has the value 10.
  - With the forwards pulse from SR..FP the register field SR..D1 shifts the content of all register fields one place forwards and accepts the 10 from SR..I1.
- Transfer of value:
  - SR..EN is activated, the function block is active.
  - SR..I1 has the value 52.
  - With the forwards pulse from SR..FP the register field SR..D1 shifts the content of all register fields one place forwards and accepts the 52 from SR..I1.
- Reset of the register:
  - SR..EN is activated, the function block is active.
  - Activating SR..RE clears the content of the register.

SR..BD and SR..I2 are for data that the function block transfers to register Q8 or D8 in a backwards direction when SR..BP is activated, a figure 148 and 149.

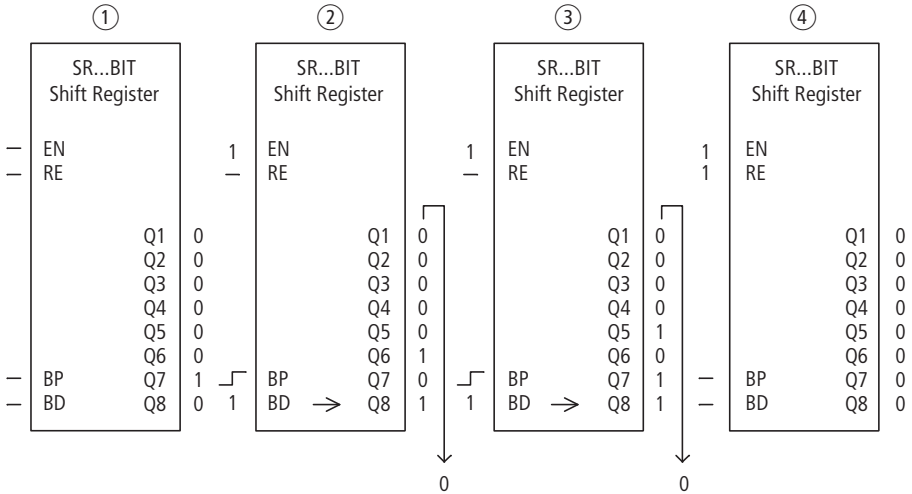

Figure 148: Shift register SR...: Backwards operation in BIT mode

- ① Initial situation:
  - SR..EN is not activated, the function block is not active.
  - SR..Q7 contains a data bit 1, a 0 is contained in the other register fields.
- ② Transfer of a data bit:
  - SR..EN is activated, the function block is active.
  - SR..BD has data bit 1.
  - With the backwards pulse from SR..BP the register field SR..Q8 shifts the content of all register fields one place back and accepts the 1 from SR..BD.
- ③ Transfer of a data bit:
  - SR..EN is activated, the function block is active.
  - SR..BD has data bit 0.
  - With the backwards pulse from SR..BP the register field SR..Q8 shifts the content of all register fields one place back and accepts the 0 from SR..BD.
- ④ Reset of the register:
  - SR..EN is activated, the function block is active.
  - Activating SR..RE clears the content of the register.

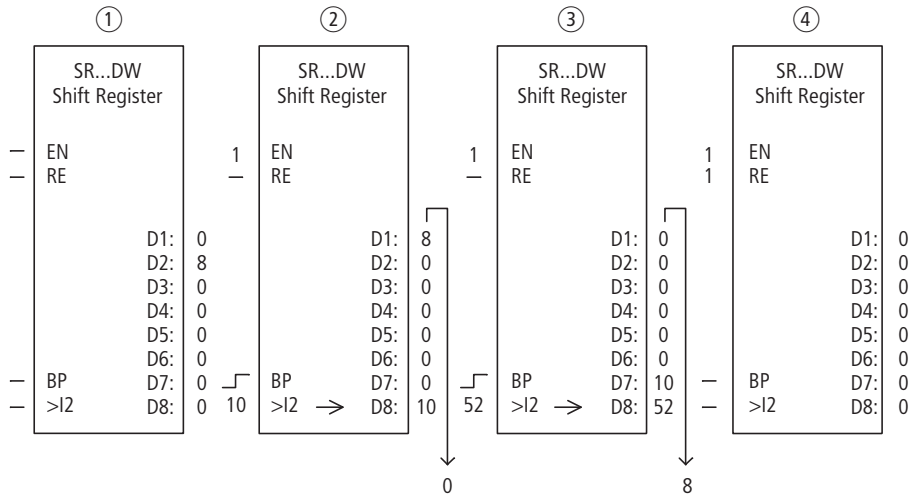

Figure 149: Shift register SR.: Backwards operation in DW mode

- ① Initial situation:
  - SR..EN is not activated, the function block is not active.
  - SR..D2 contains the value 8, a 0 is contained in the other register fields.
- ② Transfer of value:
  - SR..EN is activated, the function block is active.
  - SR..I2 has the value 10.
  - With the backwards pulse from SR..BP the register field SR..D8 shifts the content of all register fields one place back and accepts the 10 from SR..I2.
- ③ Transfer of value:
  - SR..EN is activated, the function block is active.
  - SR..I2 has the value 52.
  - With the backwards pulse from SR..BP the register field SR..D8 shifts the content of all register fields one place back and accepts the 52 from SR..I2.
- ④ Reset of the register:
  - SR..EN is activated, the function block is active.
  - Activating SR..RE clears the content of the register.

**Example 1**

A sequence of operating steps is controlled using a bit shift register.

The individual operating steps are permanently assigned to a register field. A step is initiated when its register contact is switched. As soon as it is completed, SR..FP is activated and the subsequent register contact starts the next step. The first operating step is carried out if the 1 at the register input is transferred to the register when SR.FP is activated and is indicated at SR..Q1.

```

SR12 BIT +
>I 1
>I 2
D1>

```

The figure on the left shows the parameter display and the parameter set for the function block SR12. Once shift register number 12 has been defined, you set here only BIT mode for the bit format.

The coils are programmed in the standard circuit diagram of easySafety:

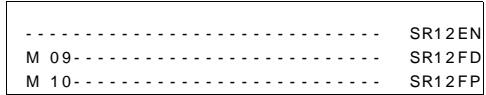

Figure 150: easySafety circuit diagram for example 1

- The enable coil SR12EN is permanently active, the function block is not switched off.
- Marker M09 transfers the 1 to SR12FD for the first step.
- Marker M10 switches the forwards pulse input coil SR12FP.

**Example 2**

Different workpieces are moved along a production line with several machining stations. An operator determines the work required for the individual workpieces, creates a production code for it and writes it into a shift register.

The workpieces reach the machining stations in this order. When the workpiece is changed, the stations read the required production steps from their permanently assigned register field.

When workpiece 1 moves to the first station, the forwards pulse input coil SR01FP and the shift register SR01 receive production code 1 at input SR01I1 from the double word marker MD11.

Production code 1 is now at the register field SR01D1 for the first machining station which reads it from double word marker MD01.

The completed workpiece is now passed to station 2. The shift register accepts the production code for the next workpiece. Production code 1 moves one place forwards, as does the remaining register content. It now stands at register output SR01D2. It reaches machining station 2 via double word marker MD02.

The process is repeated for each further workpiece and for each further machining station until the finished workpieces leave the line.

The coils are programmed in the standard circuit diagram of easySafety:

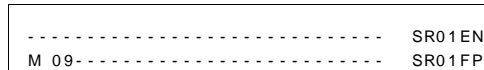

Figure 151: easySafety circuit diagram for example 2

- The enable coil SR01EN is permanently active, the function block is not switched off.
- Marker M09 switches the forwards pulse input coil SR01FP.

```
SR01 DW      +  
>I 1 MD1 1  
>I 2  
D1> MD0 1
```

```
D2> MD0 2  
D3> MD0 3  
D4>  
D5>  
D6>  
D7>  
D8>
```

The figure on the left shows the parameter display and the parameter set. After defining shift register number 01, you set here the following parameters:

- the DW mode for the double word marker format.
- the double word markers for receiving the production code.

**T, timing relay**

A timing relay is used to change the switching duration and the make and break times of a switching contact in the standard circuit diagram. The delay times can be configured between 50 ms and 99 h 59 min.

easySafety allows the use of up to 16 non-safety timing relays.

**h**

If you require a timing relay in the safety circuit diagram, use the 16 safety timing relays provided there with a similar function.

**h**

page 337 on Example with timing relay and counter function block provides information on the timing relay and counter function block.

**Function block**

Figure 152: Timing relay function block

- ① Coil T..EN: Enables the operation of the function block.
- ② Coil T..RE: Resets the timing relay to zero.
- ③ Coil T..ST: Stops the timing relay.
- ④ Input T..I1: Entry for setpoint 1.
- ⑤ Input T..I2: Entry for setpoint 2.

- ⑥ Contact T..Q1: Closes on reaching the upper setpoint.
- ⑦ Output T ..QV: Outputs the currently elapsed time.

**Wiring of the function block**

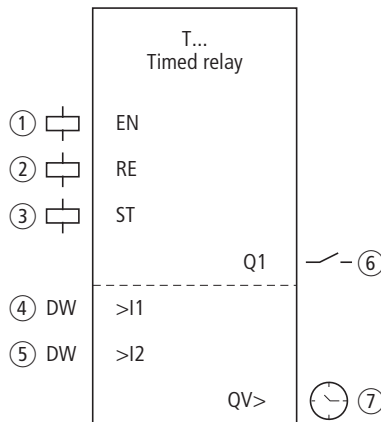
You wire the function block in the standard circuit diagram with its coils and contact.

Timing relay example:

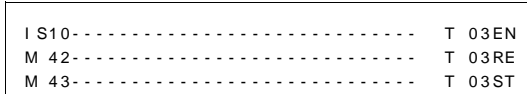

Figure 153: Wiring the function block coils

The trigger coil of the function block is connected here directly to the device inputs. A marker activates the reset coil, another marker activates the stop coil.

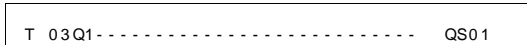
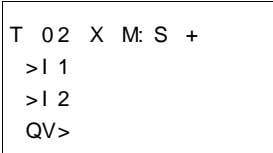

Figure 154: Wiring of the function block contact

The function block indication signal is assigned directly to a device output.

**Parameters**

When using the function block in the circuit diagram for the first time, use OK to automatically enter the general display of function block parameters, as shown in the figure on the left. Enter the function block settings here. The display contains the following elements:



T 02	Function block: Timing relay, number 02
X	Operating mode: On-delayed
M: S	Time range: Minute: Seconds
+	Parameter display: Call enabled
>I 1	Setpoint 1
>I 2	Setpoint 2 (for relay functions with 2 times)
QV>	Display: Elapsed time



The parameters consist of the following:

### Operating mode

This parameter defines the switch function of the timing relay:

Parameters	Switch function
x	Switch with on-delay
? x	Switch with on-delay and random time range
	Switch with off-delay
?	Switch with off-delay and random time range
x	On and off delayed
#	Off-delayed with random time range, setpoint retriggerable
? #	Off-delayed with random time range, retriggerable
? x	On and off delayed switching with random time, 2 time setpoints
	Single pulse switching
	Flashing, synchronous, 2 setpoints
	Flashing, asynchronous, 2 setpoints

**Time range**

The function block parameter determines in which time range and at which resolution the relay operates.

Parameters	Time range and setpoint	Resolution
S 000.000	Seconds; 0.05 to 999.995 s for constants and variable values	5 ms
M: S 00:00	Minutes:Seconds; 00:00 to 99:59 only for constants and variable values	1 s
H: M 00:00	Hours:Minutes; 00:00 to 99:59 only for constants and variable values	1 min.

h

Minimum time setting: 0.05 s (50 ms).

If a time value is less than the easySafety cycle time, the elapsed time will only be recognised in the next cycle.

**Parameter display**

The display of the parameters during operation can be disabled. Further information can be found in section "Parameter assignment from the standard circuit diagram" on page 161.

Parameters	Function
+	Parameters are displayed
-	Parameters are not displayed

This parameter is factory set to +.

### Inputs

You assign a time value at >I1 and >I2, depending on the switch function of the relay.

Parameters	Function
>I 1	Setpoint 1
>I 2	Setpoint 2

The function block inputs >I1 and >I2 can have the following operands:

- Constant.
- Markers MD, MW, MB.
- Output ...QV> of a different function block.

### Output

Output QV> supplies the currently elapsed time.

Parameters	Function
QV>	Elapsed time

You can assign the following operands to output QV>:

- Markers MD, MW, MB.

### Coils

The trigger coil in the standard circuit diagram starts the timing relay.

In the standard circuit diagram the reset coil resets the run down of the timing relay to zero.

The stop coil interrupts the run down of the timing relay in the standard circuit diagram.

Parameters	Function
T ... EN	Triggering (start) of the timing relay
T ... RE	Reset of the timing relay
T ... ST	Stop of the timing relay

**Contact**

The contact of the function block is likewise used in the standard circuit diagram. A closed contact indicates:

Parameters	Function
T . . . Q1	Time function active

**Memory requirement**

The timing relais function block requires 52 bytes of memory plus 4 bytes per function block input configured with an NU constant.

**Retention**

Timing relays can be run with retentive actual values. The number of retentive timing relays can be selected in the SYSTEM r RETENTION menu.

If a timing relay is retentive, the actual value is retained when the operating mode is changed from RUN to STOP and when the power supply is switched off.

If easySafety is started in RUN mode, the timing relay operates with the retentively saved actual value. The state of the trigger pulse must correspond to the function of the timing relay.

- Status 1 with:
  - On-delayed.
  - Single pulse.
  - Flashing.
  
- Status 0 with:
  - Off-delayed.

### Operation of the function block

The relay is started via the trigger coil T...EN and can be selectively reset via the reset coil T...RE. The third coil T...ST terminates the run down of the actual time.

#### Variable time values

If you associate the function block inputs T...I1 and T...I2 with operands, you can use variable setpoints. The setpoints are transferred as follows, depending on the time range selected:

- **S**, value in milliseconds. The last digit is rounded up or down to 0 or 5, maximum value = 999995 ms.
- **M:S**, value in seconds, maximum value = 5999 s.
- **H:M**, value in minutes, maximum value = 5999 min.

h

The delay times are the same as described for the constants.

- Examples of time range **S**:
  - Operand value 9504 -> Time value is 9.505 s.
  - Operand value 45507 -> Time value is 45.51 s.
- Examples of time range **M:S**:
  - Operand value 5999 -> Time value is 99 h, 59 min.
- Example of time range **H:M**:
  - Operand value 5999 -> Time value is 99 h, 59 min.

Different methods are used depending on the operating modes of the function block:

**Timing relay, on-delayed with and without random switching**

Random switching:

The contact of the timing relay switches randomly within the setpoint value range.

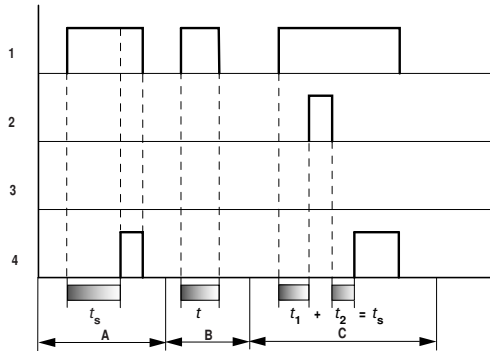

Figure 155: Signal diagram of timing relay, on-delayed (with and without random switching)

1: Trigger coil T...EN

2: Stop coil T...ST

3: Reset coil T...RE

4: Switching contact (N/O contact) T...Q1

$t_s$ : Setpoint time

- Range A: The time runs down from the set time value.
- Range B: The time does not elapse because the trigger coil drops out prematurely.
- Range C: The Stop coil stops the time from elapsing.

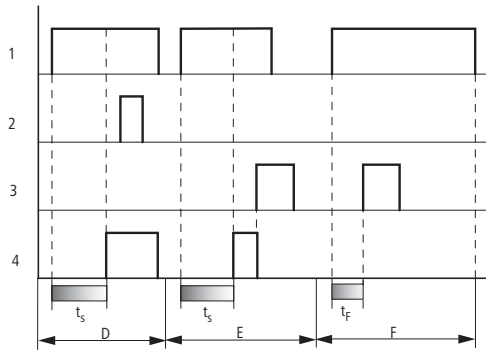

Figure 156: Signal diagram of timing relay, on delayed (with and without random switching)

- Range D: The stop coil is inoperative after the time has elapsed.
- Range E: The reset coil resets the relay and the contact.
- Range F: The Reset coil resets the time during the timeout sequence. After the reset coil drops out, the time runs down normally.

### Timing relay, off-delayed with and without random switching

Random switching, with and without retriggering  
 The contact of the timing relay switches randomly within the setpoint value range.

#### Retriggering

When the time is running and the trigger coil is reactivated or deactivated, the actual value is reset to zero. The set time of the timing relay is timed out once more.

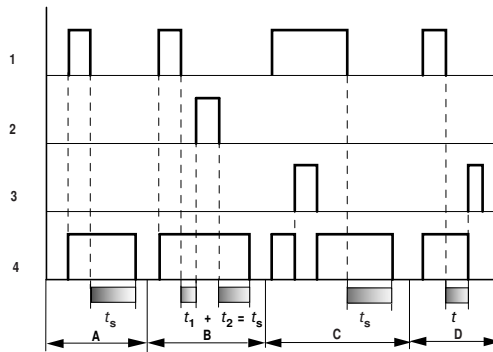

Figure 157: Signal diagram of timing relay, off delayed (with/without random switching, with/without retriggering)

1: Trigger coil T...EN

2: Stop coil T...ST

3: Reset coil T...RE

4: Switching contact (N/O contact) T...Q1

$t_s$ : Setpoint time

- Range A: The time elapses after the trigger coil is deactivated.
- Range B: The Stop coil stops the time from elapsing.
- Range C: The reset coil resets the relay and the contact. After the reset coil drops out, the relay continues to work normally.
- Range D: The Reset coil resets the relay and the contact when the function block is timing out.



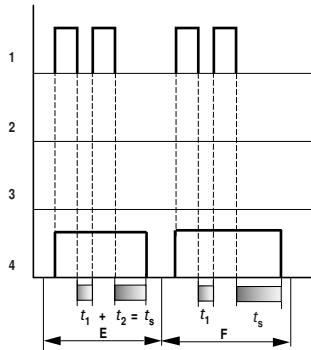

Figure 158: Signal diagram of timing relay, off delayed  
(with/without random switching, with/without retriggering)

- Range E: The Trigger coil drops out twice. The set time  $t_s$  consists of  $t_1$  plus  $t_2$  (switch function not retriggerable).
- Range F: The trigger coil drops out twice. The actual time  $t_1$  is cleared and the set time  $t_s$  elapses completely (retriggerable switch function).

**Timing relay, on delayed and off delayed with and without random switching**

Time value >I1: On delay time

Time value >I2: Off delay time

Random switching

The contact of the timing relay switches randomly within the setpoint value ranges.

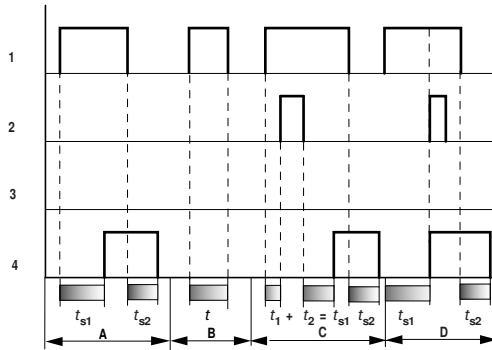

Figure 159: Operational diagrams timing relay, on and off delayed  
1

1: Trigger coil T...EN

2: Stop coil T...ST

3: Reset coil T...RE

4: Switching contact (N/O contact) T...Q1

$t_{s1}$ : Pick-up time

$t_{s2}$ : drop-out time

- Range A: The relay processes the two times without any interruption.
- Range B: The trigger coil drops out before the on-delay is reached.
- Range C: The stop coil stops the timeout of the on-delay.
- Range D: The stop coil has no effect in this range.

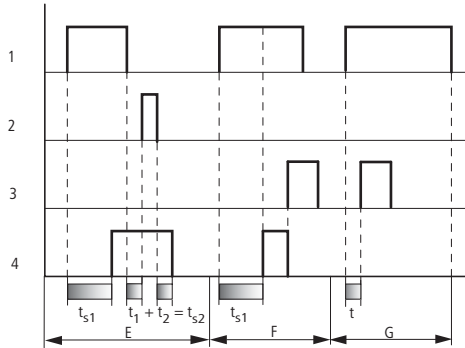

Figure 160: Operational diagrams timing relay, on and off delayed 2

- Range E: The stop coil stops the timeout of the off-delay.
- Range F: The reset coil resets the relay after the on delay has elapsed
- Range G: After the reset coil is activated, the internal time counter is reset. The switching contact remains switched off. The function relay waits for a new trigger pulse.

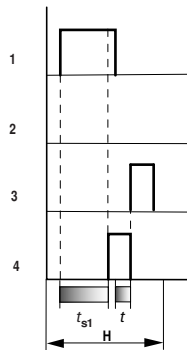

Figure 161: Operational diagrams timing relay, on and off delayed 3

- Range H: The Reset signal interrupts the timing out of the set time.

**Timing relay, single pulse**

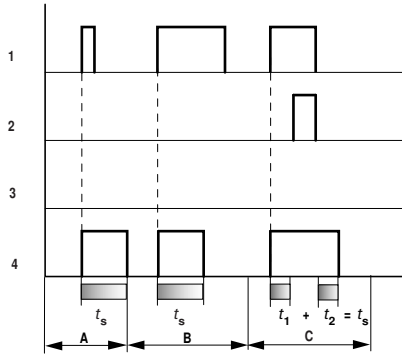

Figure 162: Signal diagram timing relay, single pulse 1

1: Trigger coil T...EN

2: Stop coil T...ST

3: Reset coil T...RE

4: Switching contact (N/O contact) T...Q1

- Range A: The trigger signal is short and is lengthened.
- Range B: The trigger signal is longer than the set time.
- Range C: The stop coil interrupts the timing out of the set time.

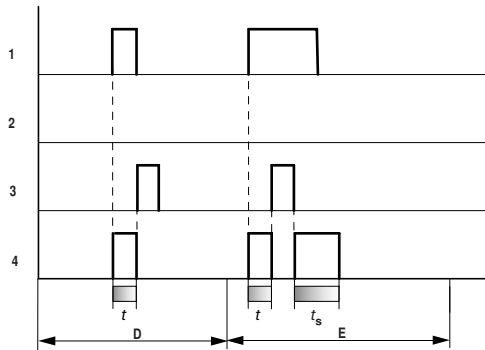

Figure 163: Signal diagram timing relay, single pulse 2

- Range D: The reset coil resets the timing relay.
- Range E: The reset coil resets the timing relay. The trigger coil is still energized after the reset coil is disconnected, whilst the delay time runs down.

### Timing relay, synchronous and asynchronous flashing

Time value  $>I1$ : Mark time

Time value  $>I2$ : Space time

Synchronous (symmetrical) flashing:  $>I1$  equal  $>I2$

Asynchronous flashing:  $>I1$  not equal  $>I2$

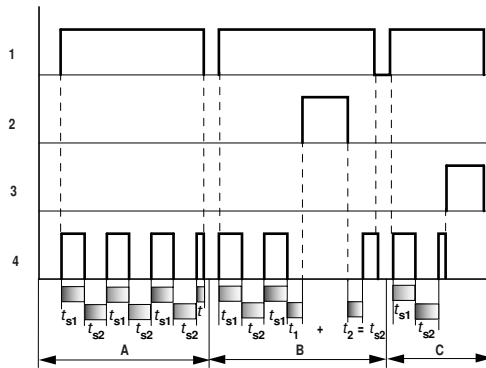

Figure 164: Signal diagram: timing relay, synchronous and asynchronous flashing

1: Trigger coil T...EN

2: Stop coil T...ST

3: Reset coil T...RE

4: Switching contact (N/O contact) T...Q1

- Range A: The relay flashes for as long as the trigger coil is activated.
- Range B: The stop coil interrupts the timing out of the set time.
- Range C: The reset coil resets the relay.

**TB, table function**

The table function block enables you to create and read table entries in the form of double words (32-bit). The function block works on the memory stack principle, whereby you can choose to apply the FIFO (first-in-first-out) or the LIFO (last-in-first-out) principle for read operations. A table can contain up to 16 double words.

easySafety allows the use of up to 16 table function blocks.

**Function block**

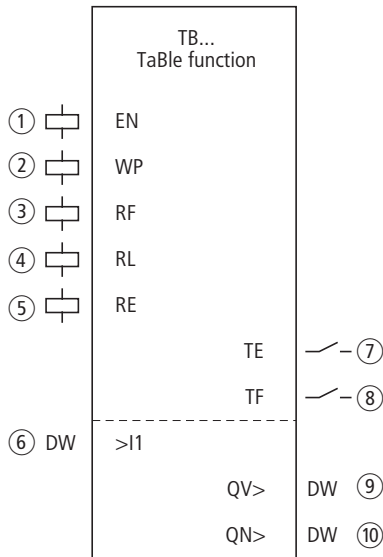

Figure 165: Table function block

- ① Coil TB..EN: Enables the operation of the function block.
- ② Coil TB..WP: Reads the value at input TB..I1, enters it in the table and outputs it at output QV.
- ③ Coil TB..RF: Clears the value entered first from the table and outputs it at output QV..
- ④ Coil TB..RL: Clears the most recently entered value from the table and outputs it at output QV..
- ⑤ Coil TB..RE: Deletes the table entries.
- ⑥ Input TB..I1: Input value for transfer to the table.
- ⑦ Contact TB..TE: Closes if the table is empty.

- ⑧ Contact TB..TF: Closes if the table is full (16 double words).
- ⑨ Output TB..QV: Supplies the current or last table entry.
- ⑩ Output TB..QN: Supplies the number of table entries.

### Wiring of the function block

You use the table function block in the standard circuit diagram with its coils and contacts.

M 10	-----	TB01EN
M 11	-----	TB01VP
M 12	-----	TB01RE
M 13	-----	TB01RF
M 13	-----	TB01RL

Figure 166: Wiring the function block coils

Markers switch the coils of the function block.

TB01TE	-----	M2
TB01TF	-----	M3

Figure 167: Wiring the function block contacts

Function block contacts TE (empty) and TF (full) display an empty or full table respectively.

Operands are assigned to inputs and outputs in the parameter display.

### Parameters

When using the function block in the standard circuit diagram for the first time, press OK to enter the general display of the function block parameters automatically, as shown in the figure on the left. This is where you make the function block settings, in this case, the allocation of the inputs and outputs to the operands. The display contains the following elements:

TB01	+
>I 1	
QV>	
QN>	

TB01	Function block: Table function, number 01
+	Parameter display: Call enabled
>I 1	Input value
QV>	Output value
QN>	Number of table entries

The parameters consist of the following:

**Parameter display**

The display of the parameters during operation can be disabled. Further information can be found in section "Parameter assignment from the standard circuit diagram" on page 161.

Parameters	Function
+	Parameters are displayed
-	Parameters are not displayed

This parameter is factory set to +.

**Input**

The value at input >I1 is read into the table when function block coil TB..WP is activated.

Parameters	Function
>I 1	Table input value: -2147483648 - +2147483647

The function block input >I1 can be assigned the following operands:

- Constant.
- Markers MD, MW, MB.
- Output ...QV> of a different function block.



## Outputs

The first and last table entry is output at output >QV, depending on the function block coils TB..RF and TB..RL.

The output >QN supplies the number of table entries.

Parameters	Function
>QV	Table output value: -2147483648 - +2147483647
>QN	Number of table entries: 0-16

The function block outputs TB..QV> and TB..QN> can have the following operands:

- Markers MD, MW, MB.

## Coils

The coils of the function block are used in the standard circuit diagram.

Use function block coil TB..EN to activate the function block.

With a rising edge at coil TB..WP the input value is read into the table.

The data at function block output QV> depends on which coil was activated:

- TB..WP: the currently read input value.
- TB..RF: the first table entry.
- TB..RL: the last table entry.

The reset coil TB..RE is used to fully clear the table.

Parameters	Function
TB..EN	Selective activation of the function block
TB..WP	Reads the value at input TB..I1 and enters it in the table.
TB..RF	Clears the first table entry and supplies it at output QV.>
TB..RL	Clears the last table entry and supplies it at output QV.>
TB..RE	Clears the table content.

**Contacts**

The contacts of the function block are evaluated in the standard circuit diagram. A closed contact indicates:

Parameters	Function
TB..TE	Table is empty
TB..TF	Table is full

**Memory requirement**

The function block requires 112 bytes of memory plus 4 bytes per constant at the input.

**Operation of the function block**

h

To allow function block table function to work, it must be enabled through an active coil TB..EN. If the coil is not active, the entire function block will be disabled.

Up to 16 table fields can be overwritten and read.

### Entering a value in the table

When the function block is active, the current value at the double word input at TB..I1 is entered in the table every time there is a rising edge at the WP coil. Coils TB..EN and TB..WP can be actuated simultaneously with a rising edge.

Each new table entry is entered behind the previous one until the sixteenth entry is reached. Immediately after the value of TB..I1 is transferred, this value is output TB..QV. Output TB..QN is incremented by 2 and then supplies the current number of table entries.

If the maximum number of 16 table entries is reached, no more data is transferred to the table and signal contact TB..TF closes. If you wish to make more table entries, read values from the table beforehand or clear the entire table with a rising edge at the RE coil.

A rising edge at the RE coil causes:

- The value at output TB..QN to be set to 0.
- The signal contact TB..TE to close.
- The signal contact TB..TF to open.

### Reading out the table

The TB..RF and TB..RL coils are used to control whether you are reading out from the start or end of the table.

A rising edge at coil RF (Read First) clears the first table entry (FIFO function) and supplies it at output TB..QV.

A rising edge at coil RL (Read Last) clears the last table entry (LIFO function ) and supplies it at output TB..QV.

With each output of a table entry the signal at output TB..QN is reduced by 1.

**Example**

An operator determines the work required for a particular workpiece, creates a production code for it and writes it in a table.

The workpieces reach the machining stations in this order. When the workpiece is changed, the stations read the required production steps from the table.

As soon as the table has reached 16 entries, the function block disables entry by the operator.

```

TB16      +
>I 1 MD10
  QV> MD11
  QN>

```

The figure on the left shows the parameter display and the parameter set for the function block TB16. Once function block number 16 has been defined, you set here the operands for the production code at input TB16I1 and the output TB16QV.

The coils and contacts are programmed in the standard circuit diagram of easySafety:

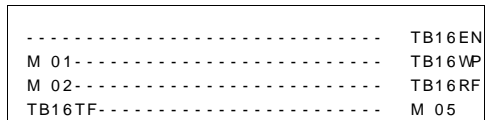

Figure 168: Table function example

- The enable coil TB16EN is permanently active, the function block is not switched off.
- With a rising edge of marker M01 write clock pulse coil TB16WP for reading the production code from MD10 and transfers it to the table.
- The contact TB16TF is used to show the sixteenth entry via the marker M 05 to the operator.
- With a rising edge from marker M02 to TB16RF the processing station reads out the first production code from the table and supplies it at output TB16QV.
- After the sixteenth read process or less, all production codes have been read out and the table is empty. Contact TB16TE closes.

**Example with timing relay and counter function block**

A warning light flashes when the counter reaches 10. In this example the function blocks C01 and T01 are wired in the standard circuit diagram and their inputs/outputs are defined.

Figure 169: Hardwiring with relays

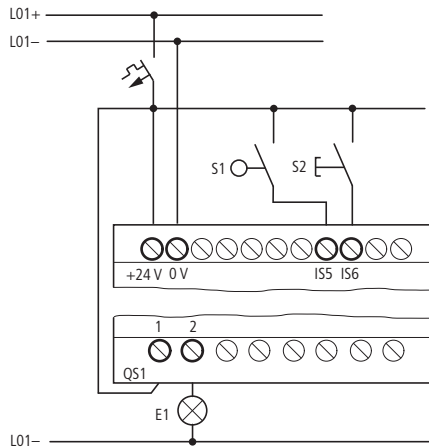

Figure 170: Wiring with easySafety ES4P-...-DRX...

### Entering the standard circuit diagram

X Enter the following circuit diagram.

I S05	-----	C 01C
I S06	-----	C 01RE
C 01OF	-----	T 01EN
T 01Q1	-----	QS01

Figure 171: Wiring of counter and timing relay

### Entering function block parameters

When entering the coils or contacts of a function block, the inputs/outputs of the function block are displayed to which you can assign parameters. The parameters can be entered via the function blocks menu.

The meaning of these parameters is explained under each function block type.

Entry:

C 01	+
>SH	+10
>SL	
>SV	

The first part of the parameter set of a counter is displayed.

X Move the cursor over the + character to the value input behind >SH:

– >SH means: Function block input upper counter setpoint value.

– The + character means that the parameters of this timing relay can be modified using the PARAMETERS menu.

X Change the upper counter setpoint to 10:

- Use to move the cursor onto the tens digit.
- Use to modify the value of the digit.

X Press OK to save the value and ESC to return to the circuit diagram.

X Set the parameters for T 01.

```

T 01      S  +
>I 1 002, 000
>I 2 002, 000
QV>

```

The timing relay works like a flashing relay. The function is set on the top right beside the number in the parameter display.

The time base is set to the right of the “flashing” function. Leave the time base set to S for seconds.

X Move the cursor to the right over the + character in order to input the time setpoint value >I1.

If you enter the same setpoint at >I1 and >I2, the timing relay operates as a synchronous flasher.

The + character means that the parameters of this timing relay can be modified using the PARAMETERS menu.

X Confirm the value input with OK.

X Use ESC to exit the function block.

Testing the circuit diagram:

X Switch easySafety to RUN mode and return to the program.

You can display every parameter set via the function relays menu.

X Move the cursor onto C 01 and press OK.

```

C 01      +
>SH +10
>SL +0
>SV +0
QV>+0

```

The parameter set for the counter is displayed with actual and setpoint values.

X Move the cursor downwards until you see the value QV>.

X Switch input IS05. The actual value changes.

```

C 01      +
>SH +10
>SL +0
>SV +0
QV>+10

```

If the actual and upper setpoint values of the counter are the same, the timing relay switches the warning light on and off every 2 seconds.

```
T 01    S  +  
>I 1  002, 000  
>I 2  002, 000  
QV>  0. 550
```

Doubling the flashing frequency:

X Select the power flow display T 01 and change the constant of the setpoint time to 001,000.

When you press OK, the warning light will flash at twice the frequency.

If the setpoint is a constant, it can also be modified via the PARAMETERS menu.

**h**

The actual value is only shown in RUN mode.



## 6 Safety function blocks

easySafety allows the processing of safety-related tasks in the safety circuit diagram. However, you should use the standard circuit diagram for standard control tasks.

You can implement safety functions using the safety function blocks. In this way, you can fully ensure the safety features of the device. easySafety also monitors the connected peripherals.

### Rules in the safety circuit diagram

External sensors and operating elements (such as Emergency-stop buttons) can be assigned to safety function blocks in the safety circuit diagram. This must be carried out observing the following rules:

I S01-----	ES01 I 1
I S02-----	ES01 I 2

The figure shows a 2-channel emergency-stop button that is connected with inputs IS1 and IS2 of the device. These two inputs must be assigned to the appropriate safety function blocks. In this case, the ES (ES = emergency-stop) is used. The assignment is carried out in the safety circuit diagram.

I S01-----	ES01 I 1
I S02-----	ES01 I 2
ES01 QS-----	QS1
	QS2

The ES safety function block monitors and evaluates the external emergency-stop button. If this is actuated, the output of the safety function block is switched off. The function block output (in our example ES01QS) switches off the device outputs of the easySafety.

I S01-- S02----	QS1
	QS2

The figure on the left shows a negative example. The 2-channel emergency-stop button here is not evaluated by one safety function block but assigned directly to the two device outputs. This is not allowed!

The following rules apply to the safety circuit diagram:

- Rule 1:  
Wire coils Ix of the safety function blocks directly to the contacts of the device inputs ISx. Branches and connections to other contacts are not permissible.

Correct:

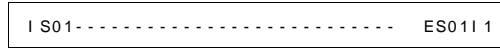

Incorrect:

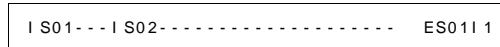

- Rule 2:  
If a device input was assigned to the input of a safety function block in accordance with rule 1, the device input must not be assigned to any other channel input of a safety function block.

Correct:

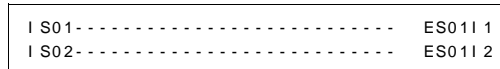

Incorrect:

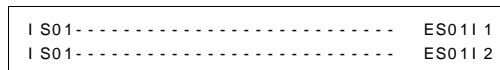

- Rule 3:  
Currently not defined.
- Rule 4:  
A safety circuit diagram must always be provided.
- Rule 5, 6 and 7:  
Currently not defined.
- Rule 8:  
A non-safety coil of a safety function block - normally the EN coil for the external enable of the function block - should only be assigned once, either in the safety circuit diagram or in the standard circuit diagram.
- Rule 9:  
Use the safety device outputs QR and QS as a coil only once, either in the safety circuit diagram or in the standard circuit diagram. In other words, a device output used in

the safety circuit diagram is no longer available in the standard circuit diagram and vice versa.

- Rule 10:  
Use the safety device outputs QR and QS only once as a coil in the safety circuit diagram.
  - Rule 11:  
When using an OM and/or ZM function block you must not use the device inputs IS1 and IS2 as contacts in the circuit diagram.
  - Rule 12:  
If you wish to implement an external function block enable (function block parameter set to EN), you must wire the EN coil of the function block in the safety or standard circuit diagram.
  - Rule 13:  
If you are using a safety function block in the safety circuit diagram, its QS output must be wired as a contact.
  - Rule 14:  
Currently not defined.
  - Rule 15:  
If the Manual Start operating mode (MST) or Controlled Start mode (CST) is set, you must wire the RE coil of the function block concerned (e.g. ES01RE) as a coil.
  - Rule 17:  
If you have set the multi-channel capability, all channels of the function block must be addressed as coils. Example of emergency-stop function block: Parameter 2CH requires the wiring of both function block channels ES011 and ES012. All the necessary coils must be wired for a function block. For example, a light curtain is always 2-channel. You must also wire the coil I1 and I2 of the LC light curtain function block, see figure below:
- |                 |         |
|-----------------|---------|
| I S05 - - - - - | LC011 1 |
| I S06 - - - - - | LC011 2 |
- Rules 18 and 19:  
Currently not defined.

- Rule 20:  
The I debounce function must not be switched on for inputs that you have used in the safety circuit diagram.
- Rule 21:  
Only wire the device outputs in the circuit diagram that are the physical device outputs. For example, not every device variant has the redundant relay output QR.
- Rule 22:  
Currently not defined.
- Rule 23:  
If the easySafety is run as a stand-alone device (i.e. not in the NET network), you cannot connect NET operands or NET function blocks (e.g. PT, GT, SC) in the standard circuit diagram or standard function block diagram.
- Rule 24:  
Some safety function block inputs can only be wired once as a coil. The reported input of the safety function block has been wired several times as a coil in the safety circuit diagram.
- Rule 25:  
Currently not defined.
- Rule 26:  
Do not assign a test signal to the inputs IS1 and IS2 if an OM or ZM function block is present in the safety circuit diagram. OM and ZM are assigned implicitly IS1 and IS2 as measuring inputs for the frequencies.
- Rule 27:  
If you are using the SG (safety gate) function block in the operating mode 1L or 2L (with guard locking monitoring) the startup test (SUT parameter) is not possible.
- Rule 29:  
A NET operand should always have a NET ID assigned to it. However, the NET ID must not be the same as the NET address.
- Rule 30:  
QS device outputs that you have used as coils in the standard circuit diagram must not be used as contacts in the safety circuit diagram.

easySafety signals when a rule is broken and specifies the number of the rule that was broken during an attempt to switch to the RUN operating mode. Both the easySafety device as well as the easySoft-Safety software help you to observe these rules by means of a plausibility check.

Further details are provided in the description of the individual function blocks.

---

## Common features

The following features described are the same for all safety function blocks. They are therefore summarised here and are not mentioned in the individual descriptions.

### Error contact ER

As soon as a safety function block finds impermissible states or timeouts of monitored times at its coils, the ER error contact closes to indicate a general error. This signal is available both in the standard as well as safety circuit diagram.

Further information on the cause of the error is provided at the DG function block output. This can be indicated in the status display or in the simulation function of easySoft-Safety. Furthermore, it is possible to evaluate the individual states of the safety function blocks and further process them by using the DG diagnostics function block in the standard circuit diagram a page 237.

### Enable parameter, EN enable coil

(external enable, factory setting: NEN)

If the enable parameter is set to EN, the enable coil of the function block is used so that the function block can be activated and deactivated externally. If this coil is not active, the function block remains deactivated and its enable contact QS stays switched off, irrespective of whether the safety conditions are fulfilled or not.

If required the function block can also work if the EN enable coil is not used. For this the enable parameter must be set to NEN (factory setting).

If an enable is required (Parameter: EN), the EN coil (e.g. ES01EN) is either addressed from the safety circuit diagram or from the standard circuit diagram.

h

The improper use of the EN enable coil as a safety input can lead to an undetected accumulation of errors. This is not permissible and must be precluded by means of a safe control system design!

### Operating mode parameter, RE reset coil

(factory setting: MST)

This parameter is used to set the startup behaviour of the safety function block. The manual restart function prevents uncontrolled starting after the power supply is switched on and after the protected area is given clearance.

- AST (Automatic start)

The enable contact closes as soon as the input circuit or circuits are closed, i.e the protected area is given clearance. If the RE reset coil is wired and the Automatic Start operating mode (AST) is set, the following warning will appear: "The reset is switched although the Automatic Start mode is selected".

h

Ensure that the AST parameter setting causes the unexpected startup of the machine or an uncontrolled change in the speed of the machine. This must be excluded by the design of a safe control system!

- MST (manual start, factory setting)

h

The precondition for this is that the safety peripherals indicate a clear protected area.

The rising edge of the Reset button at the RE reset coil causes the enable contact to close.

- CST (Controlled start)

h

The precondition for this is that the safety peripherals indicate a clear protected area.

The falling edge of the Reset button at the RE reset coil causes the enable contact to close.

If the Manual Start (MST) or Controlled Start (CST) operating mode is set, but the RE Reset coil is not wired, the following message will appear because rule 15 is being broken: "MST or CST operating mode is selected for the function block, but the Reset is not connected".

h

In the MST and CST operating modes, and after an error has been detected, operation can be enabled again with the safety function block's RE Reset coil. The precondition for this is that the safety peripherals indicate a clear protected area.

When using it in such a way, make sure that the reset pushbutton is placed in a position from which the operator can see the entire protected area.

### Parameter SUT (Startup test)

(Factory setting: No startup test)

A startup test means that the enable contact is not closed as soon as the operating voltage is applied and the protected area is clear. The protected area must be interrupted expressly once beforehand. The same applies to safety gate monitoring. In this case you first have to open the safety gate and then close it again before the enable signal appears at

the function block output. Remember to actuate the Reset button when using MST or CST operating mode in order to obtain the required function block enable.

### **QV actual value output**

The QV actual value output normally outputs the actual values of monitoring times or frequencies. You can assign the MD, MW, MB markers to it in the standard circuit diagram, e.g. with the DB block.

### **DG diagnostics output**

You use the DG diagnostics function block in the standard circuit diagram in order to evaluate the error code at the DG diagnostics output. Its 8 output contacts provide you with an accurate overview of the cause of function block error. You can forward this information or initiate a suitable routine. a section "Diagnostics using the DG diagnostics function block" , page 616.

### **Application examples**

The application examples in the descriptions of the individual safety function blocks only refer to the direct connection of the function blocks. Due to the range of different applications complete solutions cannot be illustrated at this point.



**EM, feedback circuit-  
monitoring**

The “external device monitoring” function block is used for the safety-related monitoring of external actuators such as contactors or valves.

easySafety allows the monitoring of up to 14 feedback circuits.

**Function block**

Figure 172: EM, external device monitoring function block

- ① Coil EM..OC: Activate the function block, normally by the output signal of another safety function block such as ES..QS. Use only in the safety circuit diagram.
- ② Coil EM..FL: Monitoring of the feedback loop. Use only in the safety circuit diagram.
- ③ Coil EM..RE: Function block reset in the Manual Start (MST) and Controlled Start (CST) operating modes, and start of uninterrupted operation (see also section “ES, Emergency-stop” on page 371) Use only in safety circuit diagram.
- ④ Coil EM..EN: Selective activation or deactivation of the function block function (optional). Use either in the safety or standard circuit diagram.

- ⑤ Parameter EM..FT: Monitoring time of the feedback loop, within which the EM..FL must drop out or pick up:
  - If the coil does not drop out within the specified time after EM..QS picks up, the enable is removed and an error is indicated.
  - If the coil does not pick up within the specified time after EM..QS drops out, an error is indicated and no enable is issued until the error is acknowledged.  
Can be used as an adjustable constant.
- ⑥ Contact EM..QS: Closes when conditions for safe operation are fulfilled and enables the hazardous movement.  
Use only in the safety circuit diagram.
- ⑦ Contact EM..ER: Closes in the event of an error.  
Use in the safety and in standard circuit diagram.
- ⑧ Actual value output EM..QV: Indicates the current actual value of the monitoring time.  
Indicated on the device or in easySoft-Safety.
- ⑨ Diagnostics output EM..DG: Provides information about the states of the function block.  
Evaluation only in the standard circuit diagram with the DG diagnostics function block.

**Wiring of the function block**

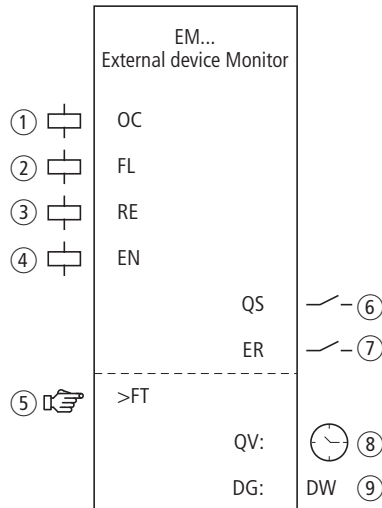
The feedback loop coil EM..FL is wired with one of the device terminals IS1 to IS14. The activation coil is normally connected to the output of a safety function block.

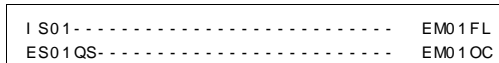

Figure 173: Wiring of input coils

You can associate the function block contact EM..QS directly with one or several of the safety device outputs.

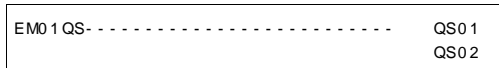

Figure 174: Wiring the enable contact to two device outputs

```

EM01  NEN  MST  *
      ***  ***
      >FT  3.0s

```

### Parameters

When using the function block in the circuit diagram for the first time, use OK to automatically enter the general display of function block parameters, as shown in the figure on the left. Enter the function block settings here. The display contains the following elements:

EM01	Function block: external device monitoring , No. 1
NEN	Enable: None required
MST	Operating mode: Manual start
>FT	Monitoring time: 3.0 seconds

The parameters consist of the following:

### Enable

The Enable parameter specifies whether an external function block enable is required. Further information can be found at section "Enable parameter, EN enable coil" on page 345.

Mode parameter	Function, parameterisation in the function block
EN	External enable required
NEN	No external enable required

This parameter is factory set to NEN, the function block is active without an external enable.

**Operating mode**

After easySafety has determined the conditions for safe operation, there are different kinds of restarts possible. They are described in greater detail as operating modes in section "Operating mode parameter, RE reset coil" on page 346.

Parameters	Function, parameterisation in the function block
MST	Manual start
CST	Controlled start
AST	Automatic start, no manual restart

The factory setting of this parameter is MST, Manual Start.

**Monitoring time**

After the EM..OC picks up, the function block monitors whether the feedback signal via coil EM..FL is generated within the specified monitoring time.

Parameters	Function, parameterisation in the function block
>FT	0.1 - 3.0 s; adjustable in increments of g?1 s

This parameter is factory set to 3.0 s.

**Outputs**

Actual value output QV: Indicates the current actual value of the monitoring time.

Diagnostics output DG: Provides information the states of the function block. It is evaluated in the standard circuit diagram e. g. with the diagnostics function block.

Parameters	Function, parameterisation in the function block
QV:	Monitoring time actual value: Time
DG:	Diagnostics: double word a table 11

Tabelle 11: Diagnostics-/Error codes

Status number		Plain text
Hexadecimal (0–F)	decimal (0-9)	
0000	0000	No Enable.
2001	8193	Enable issued; waiting for OC-/FL input.
2003	8195	Waiting for rising edge at Reset.
2004	8196	Waiting for falling edge at Reset.
2007	8199	Waiting until feedback circuit closed.
8001	32769	No fault detected in feedback circuit (QS = 1).
801A	32794	Waiting until feedback circuit open.
F00C	61452	Error: Reset and OC operated on function block startup.
F011	61457	Error: Feedback circuit not opened after time.
F012	61458	Error: Feedback circuit not closed after time.

Further information on these outputs is provided in section "Common features", page 348.

### Coils and contacts

Function block coils initiate the functions of the function block and monitor the connected safety transmitters.

The contacts of a safety function block confirm the enable conditions present, selected operating modes or indicate errors.

#### Coils

The EM..OC function block coil is used to start the monitoring function of the function block.

You can address the coil, for example, with an Enable contact of a different safety function block.

The EM..FL function block coil monitors the signal of the feedback loop in the safety circuit diagram.

The Reset coil EM..RE resets the function block in Manual Start (MST) and Controlled Start (CST) operating modes and starts normal operation. It is used in the safety circuit diagram.

If required you can enable the function block either in the safety or in the standard circuit diagram with its EM..EN enable coil.

Coil	Function
EM. . OC	Safety activation of the function block
EM. . FL	Signal of the feedback loop
EM. . RE	Reset
EM. . EN	Function block enable

**Contacts**

The EM..QS contact enables hazardous movement in the safety circuit diagram. It closes if the function block is activated safely within the monitoring time.

If the EM..ER contact is wired in the standard and/or safety circuit diagram, it indicates the presence of an error by closing.

Contact	Function
EM. . QS	Enable: <ul style="list-style-type: none"> <li>• Function block activated safely.</li> <li>• Monitoring time kept.</li> </ul>
EM. . ER	Error message (contact closed -> Error)

**Memory requirement**

The EM function block requires 28 bytes of memory.

### Operation of the function block

Precondition: The Manual Start (MST) operating mode is set.

The picking up of function block coil EM..OC activates the monitoring function and the enable contact closes after the Reset coil EM..RE picks up.

- If the actuator is switched on, the easySafety checks whether the feedback loop at the EM..FL coil opens within the monitoring time.
- If the actuator is switched off, the easySafety checks whether the feedback circuit at the EM..FL coil closes within the monitoring time.

If the actuator indicates a change in its switch position within the monitoring time, the enable contact EM..QS stays closed and enables operation.

If the feedback signal of the switch position is not generated or outside of the monitoring time, the enable is removed and the enable contact EM..QS opens. Any further enable is not generated before the function block is reset at EM..RE.

### Error detection and acknowledgement

Precondition: The Manual Start (MST) operating mode is set.

The feedback loop function block detects the timing out of the monitoring time.

Error	Error acknowledgement
Monitoring time FT timed out	EM..RE picks up

General information on Errors and how the easySafety reacts to them is provided in section "Diagnostics using the ER contact" on page 622.

**Example - Architecture of Category 4 according to EN ISO 13849-1**

Monitoring of the switch position change of two contactors with cross-circuit monitoring of the external wiring. The safety output of an ES01QS emergency-stop function block switches the EM01 OC coil and activates the function block. The enable must be removed if the feedback signal for the contactor switch position is delayed. The monitoring time is set to 2.5 seconds.

h

Note that the emergency-stop function block is in AST (Automatic Start) operating mode. Manual enabling is only possible via the Reset coil of the EM function block. If the safety application does not have an EM function block, the emergency-stop function block should be set to MST or CST mode in order to prevent unwanted enabling after the emergency-stop actuator is released.

This looks as follows in the electrical circuit diagram:



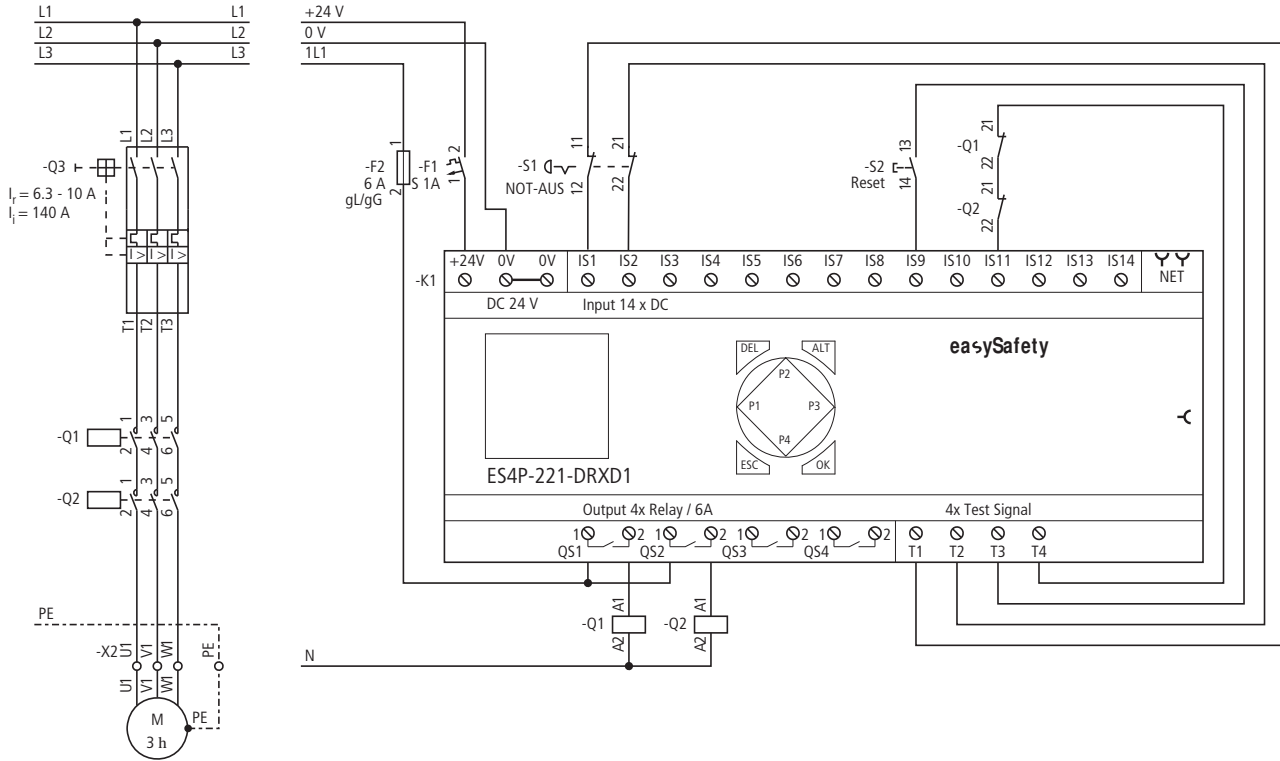

Figure 175: Feedback example: Electrical circuit diagram

The circuit diagram in easySafety has seven rungs:

I S01	-----	ES01 I 1
I S02	-----	ES01 I 2
ES01 QS	-----	EM01 OC
I S11	-----	EM01 FL
I S09	-----	EM01 RE
EM01 QS	-----	QS01
		QS02

Figure 176: Feedback example: Circuit diagram in easySafety

```

ES01 NEN AST *
      *** 2CH
>DT 3.0s

```

The safety output of the ES01QS emergency-stop function block activates the OC coil of the EM function block. The FL feedback loop coil is directly associated with the device terminal IS11 and the RE reset coil is linked to IS9. The QS enable contact switches the device outputs QS1 and QS2 directly.

```

EM01 NEN MST *
      *** **
>DT 2.5s

```

The enable parameter stays at NEN, i.e. no external enable. Likewise, the operating mode stays in the default setting Manual Start (MST) and the monitoring time is set to 2.5 seconds.

```

I S01 <- T1
I S02 <- T2
...
I S09 <- T3

```

The test signals for cross-circuit monitoring are assigned to the corresponding device inputs in the TEST SIGNALS menu.

```

I S10 <- -
I S11 <- T4
...
I S14 <- -

```

The signal diagram of the function block for this application shows:

- the dependence of the enable contact of EM01QS on the state of coils EM01OC and EM01FL.
- the relationship between exceeded monitoring time EM01DT and the error output EM01ER.
- the error acknowledgement with coil EM01RE.
- the re-enabling when the EM01RE reset coil picks up.

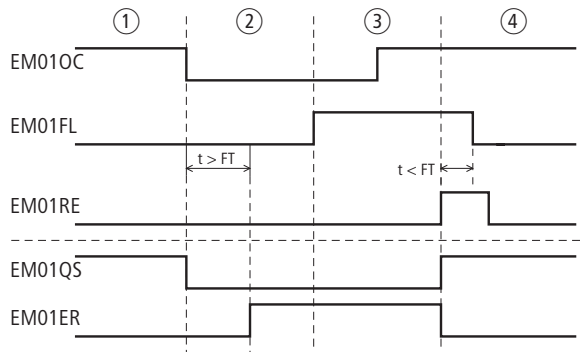

Figure 177: Feedback example: signal diagram

- ① Normal operation, emergency-stop not actuated
- ② Emergency-stop actuated -> 0 signal at EM01OC -> EM01QS switches off the device outputs -> Feedback loop not active within the monitoring time (contactor stuck) -> EM01ER error output active.
- ③ Fault in feedback loop rectified, emergency-stop released, resulting in a 1 signal at EM01OC.
- ④ Actuating the Reset button clears the error status, the device outputs are switched on and the feedback loop opens within the monitoring time.

**EN, enable switch**

Enable switches bridge the function of guards such as that of a safety gate. They therefore enable hazardous movements even when the safety gate is open. This may be necessary, for example, for setting up a machine.

**h**

When used properly, the enable does not trigger the hazardous movement but simply initiates the enable signal for triggering the movement.

The function block operates with 2-channel enable switches (2 make contacts).

easySafety allows the monitoring of up to 7 enable switches.

**Function block**

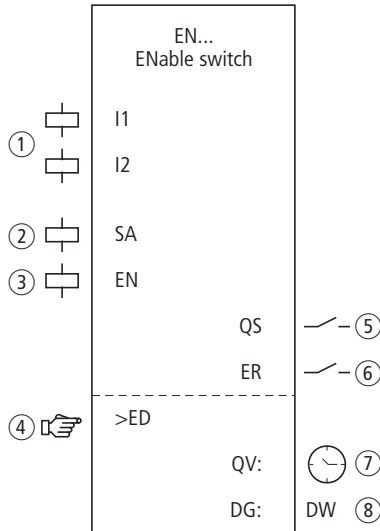

Figure 178: Enable switch function block

- ① Coils EN..I1 to EN..I2: monitoring of the enable switch. Use only in the safety circuit diagram.
- ② Coil EN..SA: safety activation of the function block. Use only in the safety circuit diagram (mandatory).
- ③ Coil EN..EN: Selective activation or deactivation of the function block function (optional). Use either in the safety or standard circuit diagram.

- ④ Parameter EN..ED: The enable time is the maximum time in which the guard is allowed to be bridged. When the time has elapsed, the enable is removed and EN..QS is opened. If the enable time is not activated, the enable contact EN..QS is closed for as long as the EN..I1 and EN..I2 function block coils are picked up.  
Can be used with the enable switch as an adjustable constant.
- ⑤ Contact EN..QS: Closes when the enable switch is actuated correctly and initiates the enable signal for special operation. Use only in the safety circuit diagram.
- ⑥ Contact EM..ER: Closes in the event of an error.  
Can be used in the safety and standard circuit diagram.
- ⑦ Actual value output EN..QV: Indicates the current actual value of the enable time.  
Indicated on the device or in easySoft-Safety.
- ⑧ Diagnostics output EN..DG: Provides information about the states of the function block.  
Evaluation only in the standard circuit diagram with the diagnostics function block DG.

### Wiring of the function block

Wire its coils EN..I1 and EN..I2 directly to the device terminals IS1 to IS14. Example of the assignment of the enable switch to the safety function block inputs:

I S01-----	EN01 SA
I S02-----	EN011 1
I S03-----	EN011 2

Figure 179: Wiring of input coils

You can associate the function block contact EN..QS directly with one or several safety device outputs, for example:

EN01 QS-----	QS01
	QS02

Figure 180: Wiring the enable contact to two device outputs

```

EN01  NEN  ***  *
      ***  ***
>ED  OFF
    
```

**Parameters**

When using the function block in the circuit diagram for the first time, use OK to automatically enter the general display of function block parameters, as shown in the figure on the left. Enter the function block settings here. The display contains the following elements:

EN01	Function block: enable switch no. 01
NEN	Enable: None required
>ED	Enable time: OFF (no monitoring time active).

The parameters consist of the following:

**Enable**

The Enable parameter specifies whether an external function block enable is required. Further information can be found in section "Enable parameter, EN enable coil" on page 345.

Parameters	Function, parameterisation in the function block
EN	External enable required
NEN	No external enable required

This parameter is factory set to NEN, the function block is active without an external enable.

### Enable time

When activated you can define a maximum permissible enable time for bridging the guard.

Parameters	Function, parameterisation in the function block
>ED	OFF; 0.5 - 10.0 min; adjustable in increments of 0.5 min.

This parameter is factory set to OFF. This means that no maximum permissible enable time is required.

### Outputs

Actual value QV: Indicates the current actual value of the enable time.

Diagnostics output DG: Provides information the states of the function block. It is evaluated in the standard circuit diagram e. g. with the diagnostics function block.

Parameters	Function, parameterisation in the function block
QV:	Actual enable time: Time
DG:	Diagnostics: double word a table 12

Tabelle 12: Diagnostics-/Error codes

Status number		Plain text
Hexadecimal (0–F)	decimal (0-9)	
0000	0000	No Enable.
2001	8193	Enable issued; waiting for input.
2005	8197	Only one channel has been opened.
2012	8210	Enable switch in OFF position.
8002	32770	Switch in ON position (QS = 1).
F002	61442	Error: Enable duration exceeded.
F00E	61454	Error: Only one channel was opened and closed.
F00F	61455	Error: Undefined switch position.

Further information on these outputs is provided in section “Common features”, page 348.

**Coils and contacts**

Function block coils initiate the functions of the function block and monitor the connected safety transmitters.

The contacts of a safety function block confirm the enable conditions present, selected operating modes or indicate errors.

**Coils**

Connect the function block coils EN..I1 and EN..I2 directly to the device terminals IS1 to IS14. The coils monitor the signal of the light curtain in the safety circuit diagram. The coils monitor the signal of the enable switch in the safety circuit diagram.

Use function block coil EN..SA to activate the function block.

Associate the coil in the safety circuit diagram for example with the enable contact of another safety function block.

**h**

Activate the bridging of the guard with a key switch. The key switch should be installed so that you have a complete view of the hazardous zone.



If required you can enable the function block either in the safety or in the standard circuit diagram with its EN..EN enable coil.

Coil	Function
EN. . I 1	Enable switch channel 1
EN. . I 2	Enable switch channel 2
EN. . SA	Safety activation of the function block
EN. . EN	Function block enable

### Contacts

The EN..QS contact in the safety circuit diagram enables hazardous movement. It closes after the enable has been initiated.

If the EN..ER contact is wired in the standard and/or safety circuit diagram, it indicates the presence of an error by closing.

Contact	Function
EN. . QS	Enable (contact closed -> Enable initiated)
EN. . ER	Error signal (contact closed-> error)

### Memory requirement

The EN function block requires 32 bytes of memory.

**Operation of the function block**

The safety function of the function block is based on the following contact mirror variants of the enable switch:

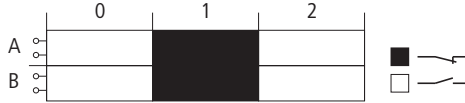

Figure 181: Contacting of the enable switch with three stages 0, 1, 2 and two contacts A, B

These allow the enable to be initiated as soon as the function block coil EN..SA activates the monitoring and the enable switch is in position 0.

Pressing the enable switch to position 1 closes the enable contact EN..QS.

Position 2 (panic position, for example caused by clenching of the hand) removes the enable and opens EN..QS.

The enable contact stays open when switch position 0 is restored, also when passing through switch position 1.

**Error detection and acknowledgement**

The enable switch function block detects the timing out of the enable time.

Error	Error acknowledgement
Wire break or interruption of the activation of EN..I1 and EN..I2.	Return of the enable switch to position 0.
Timing out of the enable time ED.	Return of the enable switch to position 0.

General information on Errors and how the easySafety reacts to them is provided in section "Diagnostics using the ER contact" on page 622.

**Example**

Monitoring of an enable switch with cross-circuit monitoring of the external wiring. Activation coil EN01SA is triggered by a key switch. The enable switch must only be active at reduced speed. This condition is scanned with the OM (maximum speed monitoring) function block. The wiring of the OM function block is described in section "OM, Maximum speed monitoring" on page 434.

Moving the switch from position 0 to 1 triggers the enable. The enable contact EN01QS of the function block closes and the signal is assigned to the safety marker MS05 for further processing.

The enable is removed if the switch is held down in position 2 or released and is thus returned to position 0. When returning to switch position 0 from switch position 2, there is no enable when passing through position 1.

The guard can only be bridged for up to 3 minutes.

This looks as follows in the electrical circuit diagram:

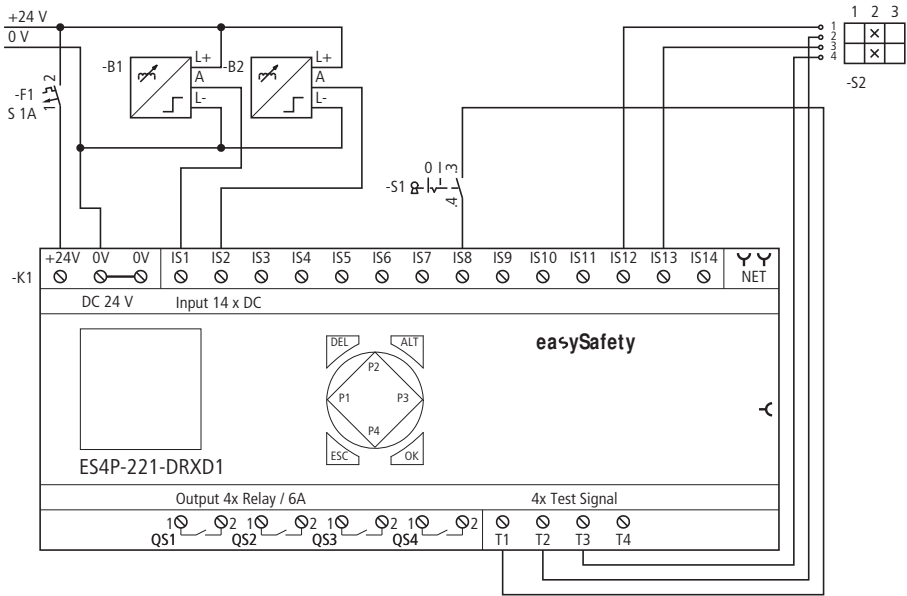

Figure 182: Enable switch example: Electrical circuit diagram

The circuit diagram in easySafety has five rungs:

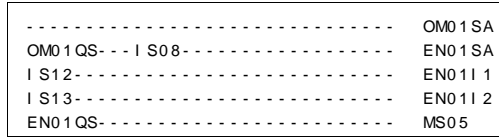
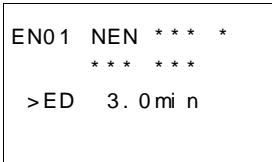
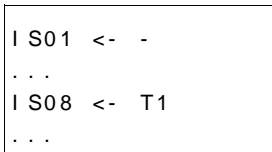

Figure 183: Enable switch example: Circuit diagram in easySafety.

The enable contact of the overspeed monitoring function block OM01QS and the key switch S1 at IS08 switch coil EN01SA. The test signals T2 and T3 feed the enable switch S2 connected to the device terminals IS12 and IS13.



The parameters for the enable are kept at the default setting and the maximum permissible enable time is kept at 3.0 minutes.



The test signals for cross-circuit monitoring are assigned to the corresponding device inputs in the TEST SIGNALSmenu.

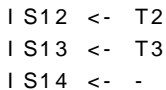

The signal diagram of the function block for this application shows the dependence of the enable contact EN01QS on the status of coils EN01SA, EN01I1 and EN01I2 as well as the timeout of the enable time:

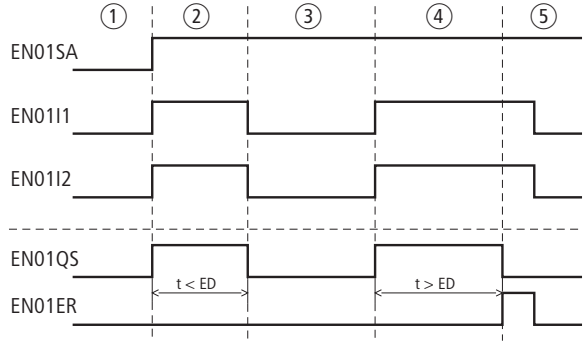

Figure 184: Enable switch example:

Enable switch positions:

- ① The key switch is in the position for setting operation and the motor speed is slow. The enable switch can therefore be activated.
- ② Actuation of the enable switch (switch position 1). The enable time is less than the time set at ED. The enable at EN01QS is initiated.
- ③ Release of the enable switch, the enable at EN01QS is removed.
- ④ Actuation of the enable switch (switch position 1). The enable time is greater than the time set at ED. The enable at EN01QS is removed after the enable time has elapsed. The function block outputs an error signal via EN01ER.
- ⑤ Acknowledgement of the error signal by releasing the enable switch.

## ES, Emergency-stop

The emergency-stop function block is used for the safety-related single or two-channel monitoring of emergency-stop circuits. This enables the safe stopping of a hazardous movement if the immediate disconnection of the power supply does not cause hazardous states.

easySafety enables the monitoring of up to 14 single-channel emergency-stop circuits or 7 two-channel emergency-stop circuits.

### Function block

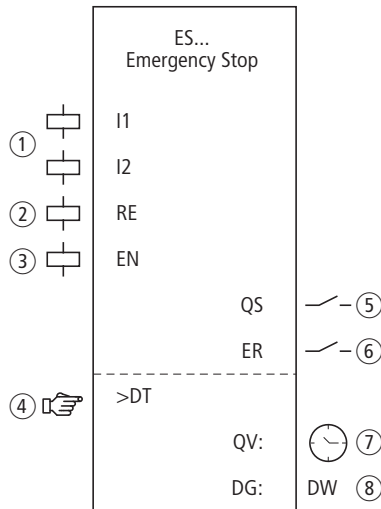

Figure 185: Emergency-stop function block

- ① Coils ES..I1 and ES..I2: Monitoring of the 1 or 2-channel emergency-stop switch.  
Use only in the safety circuit diagram.
- ② Coil ES..RE: Reset of the function block to Manual Start (MST) and Controlled Start (CST) modes and starting of normal operation.  
Use only in the safety circuit diagram.
- ③ Coil ES..EN: Selective activation or deactivation of the function block function (optional).  
Optional use either in the safety or standard circuit diagram.

- ④ Parameter ES..DT: Discrepancy time within which both coils ES..I1 and ES..I2 must have picked up.  
Use with 2-channel emergency-stop as an adjustable constant.
- ⑤ Contact ES..QS: Closes when conditions for safe operation are fulfilled and enables the hazardous movement.  
Use only in the safety circuit diagram.
- ⑥ Contact ES..ER: Closes in the event of an error.  
Use in the safety and in standard circuit diagram.
- ⑦ Actual value output ES..QV: Indicates the current actual value of the discrepancy time.  
Indicated on the device or in easySoft-Safety.
- ⑧ Diagnostics output ES..DG: Provides information about the states of the function block.  
Evaluation in the standard circuit diagram with the DG diagnostics function block.

**Wiring of the function block**

Wire its coils ES..I1 and ES..I2 directly to the device terminals IS1 to IS14. Example of a 2-channel emergency-stop function block:

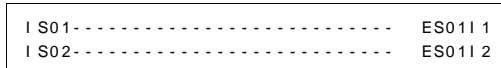

Figure 186: Wiring of input coils

You can associate the function block contact ES..QS directly with one or several safety device outputs, for example:

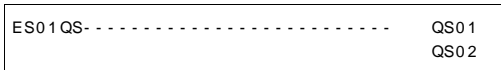

Figure 187: Wiring the enable contact to two device outputs



ES01	NEN	MST	*
	***	2CH	
>DT	3.0s		

### Parameters

When using the function block in the circuit diagram for the first time, use OK to automatically enter the general display of function block parameters, as shown in the figure on the left. Enter the function block settings here. The display contains the following elements:

ES01	Function block: emergency-stop no. 01
NEN	Enable: None required
MST	Operating mode: Manual start
2CH	Evaluation: 2-channel emergency-stop circuit
>DT	Discrepancy time: 3.0 seconds

The parameters consist of the following:

#### Enable

The enable parameter allows the use of the enable coil for activation or deactivation. Further information can be found at section "Enable parameter, EN enable coil" on page 345.

Parameters	Function, parameterisation in the function block
EN	External enable required
NEN	No external enable required

This parameter is factory set to NEN, the function block is active without an external enable.

**Operating mode**

After easySafety has determined the conditions for safe operation, there are different kinds of restarts possible. They are described in greater detail as operating modes in section “Operating mode parameter, RE reset coil” on page 346.

Parameters	Function, parameterisation in the function block
MST	Manual start
CST	Controlled start
AST	Automatic start, no manual restart

The factory setting of this parameter is MST, Manual Start.

**Evaluation**

The parameter sets the function block for monitoring emergency-stop switches with one or two break contacts.

Parameters	Function, parameterisation in the function block
1 CH	1-channel evaluation
2 CH	2-channel evaluation

easySafety is defined with a default setting for 2-channel evaluation.

**Discrepancy time**

The discrepancy time ES..DT can be set when the function block is set for 2-channel emergency-stop monitoring.

Parameters	Function, parameterisation in the function block
>DT	OFF; 0.5 - 3.0 s; adjustable in increments of 0.5 s

easySafety is factory set with a discrepancy time of 3.0 s.

## Outputs

The actual value output QV: Indicates the current actual value of the discrepancy time.

Diagnostics output DG: Provides information the states of the function block. It is evaluated in the standard circuit diagram e. g. with the diagnostics function block.

Parameters	Function, parameterisation in the function block
QV:	Actual value discrepancy time: Time
DG:	Diagnostics: double word a table 13

Table 13: Diagnostics-/Error codes

Status number		Plain text
Hexadecimal (0–F)	decimal (0-9)	
0000	0000	No Enable.
2001	8193	Enable issued; waiting for first (or only) input.
2002	8194	Waiting for second input.
2003	8195	Waiting for rising edge at Reset.
2004	8196	Waiting for falling edge at Reset.
2005	8197	Only one channel has been opened.
8003	32771	Emergency-Stop not operated (QS = 1).
F001	61441	Error: Discrepancy time expired.
F00B	61451	Error: Reset and inputs operated on function block startup.
F00E	61454	Error: Only one channel was opened and closed.

Further information on these outputs is provided in section "Common features", page 348.

**Coils and contacts**

Function block coils initiate the functions of the function block and monitor the connected safety transmitters.

The contacts of a safety function block confirm the enable conditions present, selected operating modes or indicate errors.

**Coils**

Connect the function block coils ES..I1 and ES..I2 directly to the device terminals IS1 to IS14. The coils monitor the signal of the light curtain in the safety circuit diagram. The coils monitor the signal of the Emergency-Stop in the safety circuit diagram.

The Reset coil ES..RE resets the function block in Manual Start (MST) and Controlled Start (CST) operating modes and starts normal operation. It is used in the safety circuit diagram.

The function block is enabled either in the safety circuit diagram or in the standard circuit diagram by means of its enable coil ES..EN.

Coil	Function
ES..I1	Emergency-stop switch, channel 1
ES..I2	Emergency-stop switch, channel 2
ES..RE	Reset
ES..EN	Function block enable

### Contacts

The ES..QS contact enables hazardous movement in the safety circuit diagram. It is closed as long as the emergency-stop switch has not been triggered.

If the ES..ER contact is wired in the standard and/or safety circuit diagram, it indicates the presence of an error by closing.

- Timeout of discrepancy time
- With 2-channel operation, only 1 channel opens and closes.

Contact	Function
ES..QS	Enable (contact closed -> Emergency-stop switch not triggered)
ES..ER	Error message (contact closed -> Error)

### Memory requirement

The ES function block requires 28 bytes of memory.

### Operation of the function block

If all conditions for safe operation are fulfilled, the enable contact ES..QS is closed and enables operation.

If one of the emergency-stop channel coils drops out, the enable is removed, the enable contact ES..QS opens and the hazardous movement can be stopped.

### Error detection and acknowledgement

The emergency-stop function block detects the timing out of the discrepancy time.

Error	Error acknowledgement
Timeout of discrepancy time DT	2-channel operation: dropping out of ES..I1 and ES..I2

**Example 1 - Architecture of category 4 in accordance with EN ISO 13849-1**

Monitoring of a 2-channel emergency-stop switch and cross-circuit monitoring of its external wiring. The actuation of the pushbutton triggers the emergency-stop function. Releasing the Reset button after the removal of the hazard initiates the re-enabling in a controlled manner. The discrepancy time is set for 0.5 seconds.

The break contacts of the emergency-stop switch S1 are connected to the device terminals IS9 and IS10 and are provided with the test signals T3 and T4. The safety device outputs QS1 and QS3 switch the contactors Q1 and Q2 directly. The enable is initiated by the function block after the emergency-stop switch has been released and the Reset button has been actuated.

This looks as follows in the electrical circuit diagram:

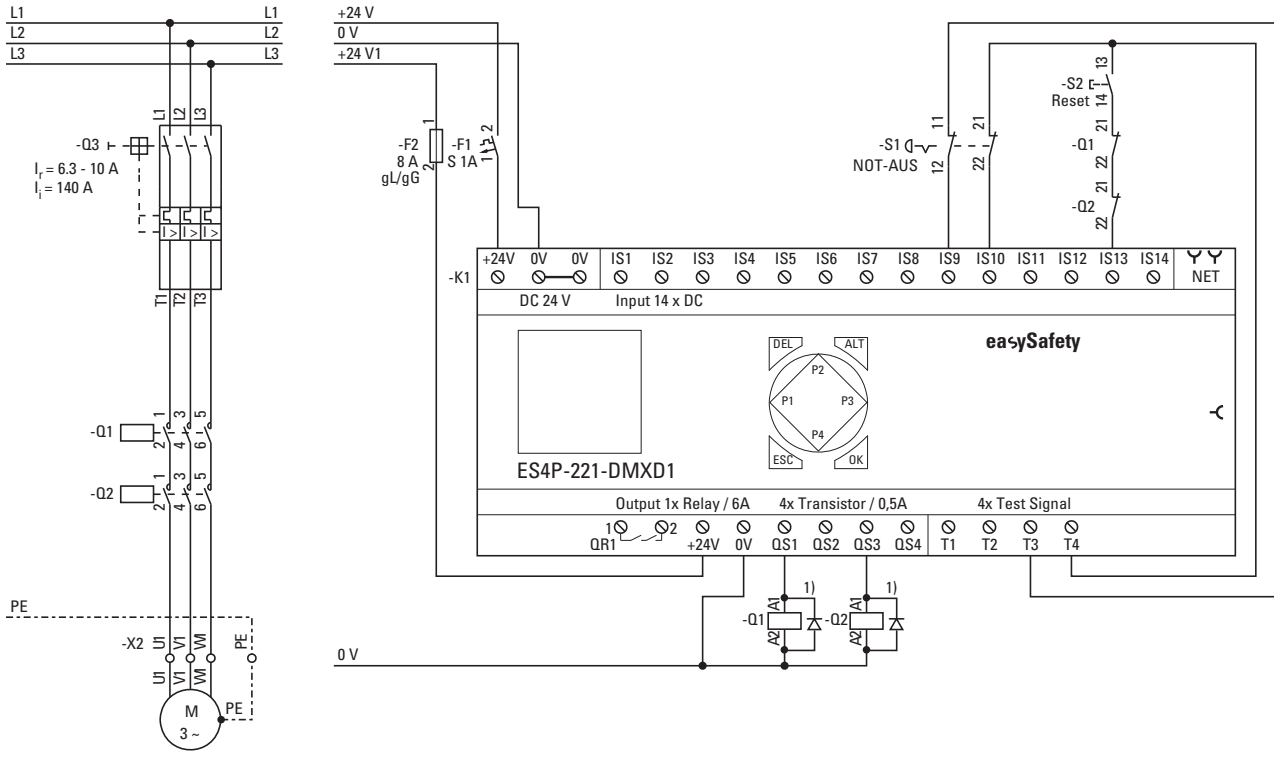

Figure 188: Emergency-stop example: Electrical circuit diagram  
 1) Use free-wheel diode suppressors for ES4P-221-DMX.. devices with device version 02 and 10

The circuit diagram in easySafety has five rungs:

I S09-----	ES01 I 1
I S10-----	ES01 I 2
I S13-----	ES01 RE
ES01 QS-----	QS01
	QS03

Figure 189: Emergency-stop example: Circuit diagram in easySafety

The ES01I1 and ES01I2 input coils are directly associated with the device terminals IS9 and IS10 and the Reset coil ES01RE is linked to IS13. The ES01QS enable contact switches the device outputs QS1 and QS3 directly.

```

ES01 NEN CST *
      *** 2CH
>DT  0.5s
DG:

```

The enable parameter stays at NEN, i.e. no external enable. The operating mode is changed to CST "Controlled Start". The evaluation of the emergency-stop button stays set to 2-channel operation (2CH) and the discrepancy time to 0.5 seconds.

```

I S01 <- -
...
I S09 <- T3
I S10 <- T4 *

```

The test signals for cross-circuit monitoring are assigned to the corresponding device inputs in the TEST SIGNALS menu.

```

...
I S13 <- T4 *
I S14 <- -

```



The signal diagram of the function block for this application shows:

- the dependence of the enable contact of ES01QS on the state of coils ES01I1 and EM01I2.
- the relationship between elapsed discrepancy time ES01DT and the error output ES01ER.
- the error acknowledgement with coils ES01I1 and ES01I2.
- the controlled re-enabling after the hazard has been rectified and the Reset coil ES01RE has dropped out.

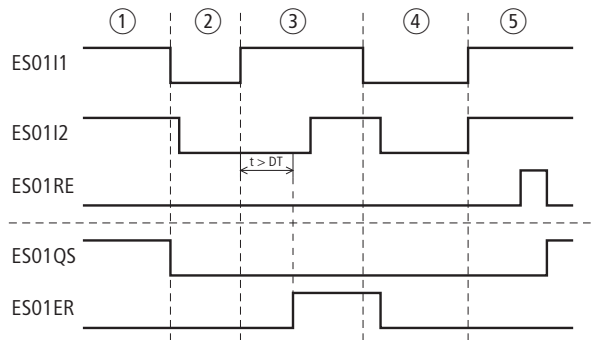

Figure 190: Example emergency-stop: signal diagram

- ① Normal operation.
- ② Triggered emergency-stop after a hazardous situation occurs.
- ③ Discrepancy time exceeded when releasing the emergency-stop button. Error signal at contact ES01ER.
- ④ Error acknowledgement by actuation of the emergency-stop pushbutton.
- ⑤ Release of the emergency-stop pushbutton and subsequent controlled re-enabling after the Reset coil has dropped out.

**FS, safety foot switch**

Safety foot switches bridge the function of guards such as that of a safety gate. They therefore enable hazardous movements even when the safety gate is open. This may be necessary, for example, for setting up a machine.

**h**

When used properly, the enable does not trigger the hazardous movement but simply initiates the enable signal for triggering the movement.

The make contact closes when the foot pedal is actuated up to the pressure point. If in the event of a hazard the pedal is actuated beyond the pressure point, the positively driven break contact is opened and mechanically interlocked. An additional pushbutton is implemented for the release. The safety foot switch does not then move over the switch on point when it is reset.

The function block operates with 2-channel or 4-channel safety foot switches. easySafety allows the monitoring of up to 7 safety foot switches.

## Function block

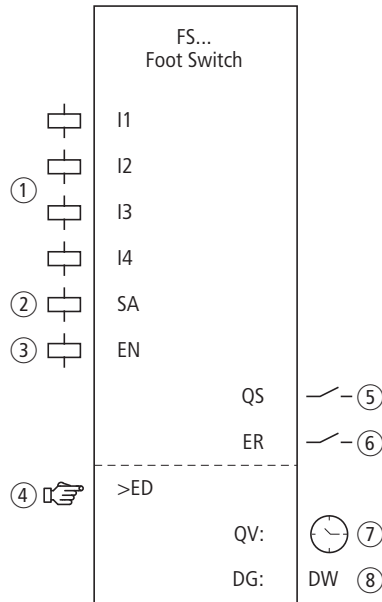

Figure 191: Safety foot "switch function block"

- ① Coils FS..I1 to FS..I4: monitoring of the 2-channel and 4-channel foot switch.  
Use only in the safety circuit diagram.
- ② Coil FS..SA: safety activation of the function block.  
Use only in the safety circuit diagram.
- ③ Coil FS..EN: Selective activation or deactivation of the function block function (optional).  
Use either in the safety or standard circuit diagram.
- ④ Parameter FS..ED: The enable time is the maximum time in which the guard is allowed to be bridged. When the time has been exceeded, the enable is removed and FS..QS is opened. If the enable time is not activated, the enable contact FS..QS is closed for as long as the FS..I1 to FS..I2 or FS..I1 to FS..I4 function block coils have picked up.  
Can be used with foot switch as an adjustable constant.
- ⑤ Contact FS..QS: Closes when the foot switch is actuated correctly and initiates the enable signal for special operation.  
Use only in the safety circuit diagram.

- ⑥ Contact FS..ER: Closes in the event of an error.  
Use in the safety and in standard circuit diagram.
- ⑦ Actual value output FS..QV: Indicates the current actual value of the enable time.  
Indicated on the device or in easySoft-Safety.
- ⑧ Diagnostics output FS..DG: Provides information about the states of the function block.  
Evaluation only in the standard circuit diagram with the diagnostics function block DG.

**Wiring of the function block**

Wire its FS..I1 and FS..I2 coils directly to device terminals IS1 to IS14. Example of the assignment of the 2-channel foot switch to the safety function block inputs:

I S01-----	EN01 SA
I S02-----	FS011 1
I S03-----	FS011 2

Figure 192: Wiring of input coils

You can associate the function block contact FS..QS directly with one or several safety device outputs, for example:

FS01 QS-----	QS0 1
	QS0 2

Figure 193: Wiring the enable contact to two device outputs

```

FS01 NEN *** *
      *** 4CH
      >ED OFF

```

### Parameters

When using the function block in the circuit diagram for the first time, use OK to automatically enter the general display of function block parameters, as shown in the figure on the left. Enter the function block settings here. The display contains the following elements:

FS01	Safety foot switch function block, No. 01
NEN	Enable: None required
4CH	Number of switch channels: 4 channels
>ED	Enable time: OFF (no monitoring time active).

The parameters consist of the following:

### Enable

The Enable parameter specifies whether an external function block enable is required. Further information can be found at section "Enable parameter, EN enable coil" on page 345.

Parameters	Function, parameterisation in the function block
EN	External enable required
NEN	No external enable required

This parameter is factory set to NEN, the function block is active without an external enable.

### Evaluation

The parameter sets the function block for monitoring foot switches with two or 4 break contacts.

Parameters	Function, parameterisation in the function block
2CH	2-channel evaluation
4CH	4-channel evaluation

easySafety is defined with a default setting for 4-channel evaluation.

**Enable time**

When activated you can define a maximum permissible enable time for bridging the guard.

Parameters	Function, parameterisation in the function block
>ED	OFF; 0.5 - 10.0 min; adjustable in increments of 0.5 min.

This parameter is factory set to OFF. This means that no maximum permissible enable time is required.

**Outputs**

Actual value output QV: Indicates the current actual value of the enable time.

Diagnostics output DG: Provides information the states of the function block. It is evaluated in the standard circuit diagram e. g. with the diagnostics function block.

Parameters	Function, parameterisation in the function block
QV:	Actual enable time: Time
DG:	Diagnostics: double worda table 14

Tabelle 14: Diagnostics-/Error codes

Status number		Plain text
Hexadecimal (0–F)	decimal (0-9)	
0000	0000	No Enable.
2001	8193	Enable issued; waiting for first (or only) input.
2011	8209	Foot switch not operated (position 0).
2013	8211	Foot switch in panic position (position 2).
2014	8212	Undefined foot switch position
8004	32772	Foot switch operated (position 1).
F002	61442	Error: Enable duration exceeded.
F00F	61455	Error: Foot switch 1/2 position is not permissible after enable.
F010	61456	Error: Position 1 not permissible after panic position.

Further information on these outputs is provided in section "Common features", page 348.

### Coils and contacts

Function block coils initiate the functions of the function block and monitor the connected safety transmitters.

The contacts of a safety function block confirm the enable conditions present, selected operating modes or indicate errors.

#### Coils

Connect the function block coils FS..I1 and FS..I4 directly to the device terminals IS1 to IS14. The coils monitor the signal of the foot switch in the safety circuit diagram.

Use function block coil FS..SA to activate the function block.

Associate the coil only in the safety circuit diagram for example with the enable contact of another safety function block.

**h**

Activate the bridging of the guard with a key switch. The key switch should be installed so that you have a complete view of the hazardous zone.

If required you can enable the function block either in the safety or in the standard circuit diagram with its FS..EN enable coil.

Coil	Function
FS. . I 1	Foot switch channel 1
FS. . I 2	Foot switch channel 2
FS. . I 3	Foot switch channel 3
FS. . I 4	Foot switch channel 4
FS. . SA	Safety activation of the function block
FS. . EN	Function block enable

**Contacts**

The FS..QS contact enables hazardous movement in the safety circuit diagram. It closes after the enable has been initiated.

If the FS..ER contact is wired in the standard and/or safety circuit diagram, it indicates the presence of an error by closing.

Contact	Function
FS. . QS	Enable (contact closed -> Foot switch initiates enable)
FS. . ER	Error message (contact closed -> Error)

**Memory requirement**

The FS function block requires 32 bytes of memory.



### Operation of the function block

The safety function of the function block is based on the following contact mirror variants of the foot switch.

2-channel (make/break combination):

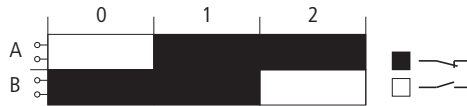

Figure 194: Contacting of the 2-channel foot switch with three stages 0, 1, 2 and two contacts A, B

Connect the 1st channel to FS..I1, the 2nd channel to FS..I2.

4-channel (2 make/break combinations):

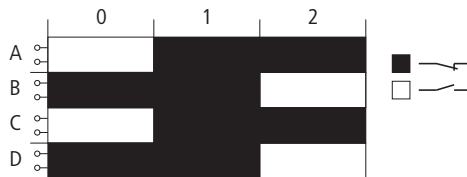

Figure 195: Contacting of the 4-channel foot switch with three stages 0, 1, 2 and four contacts A, B, C, D

Connect the 1st channel to FS..I1, the 2nd channel to FS..I2, the 3rd channel to FS..I3 and the 4th channel to FS..I4.

You can use the foot switch to initiate the enable signal under the following conditions:

- The foot switch is in position 0.
- Function block coil FS..SA is activated.
- Pressing the enable switch to position 1 closes the enable contact FS..QS.

Position 2 (panic position, for example if you fully press the foot switch) removes the enable and opens FS..QS.

With both switch types (2 or 4-channel) the enable contact stays open when switch position 0 is resumed, also when passing through switch position 1.

**Error detection and acknowledgement**

The safety foot switch detects the timing out of the enable time.

Error	Error acknowledgement
Wire break or interruption of the activation of FS..I1 and FS..I4.	Return of the foot switch to position 0.
Timing out of the enable time ED.	Return of the foot switch to position 0.

General information on Errors and how the easySafety reacts to them is provided in section “Diagnostics using the ER contact” on page 622.

**Example**

Monitoring of a 2-channel foot switch with cross-circuit monitoring of the external wiring. Activation coil FS01SA is triggered by a key switch.

**h**

The foot switch must only be active at reduced speed.

This condition is scanned with the OM (maximum speed monitoring) function block. The wiring of the OM function block is described in section "OM, Maximum speed monitoring" on page 434.

Moving the switch from position 0 to 1 triggers the enable. The enable contact FS01QS of the function block closes and the signal is assigned to the safety marker MS05 for further processing.

The enable is removed if you continue to hold down the switch in position 2 or take your foot off the switch to thus return it to position 0. When returning to switch position 2 from switch position 0, there is no enable when passing through position 1.

The guard can only be bridged for up to 3 minutes.

The electrical circuit is as follows:

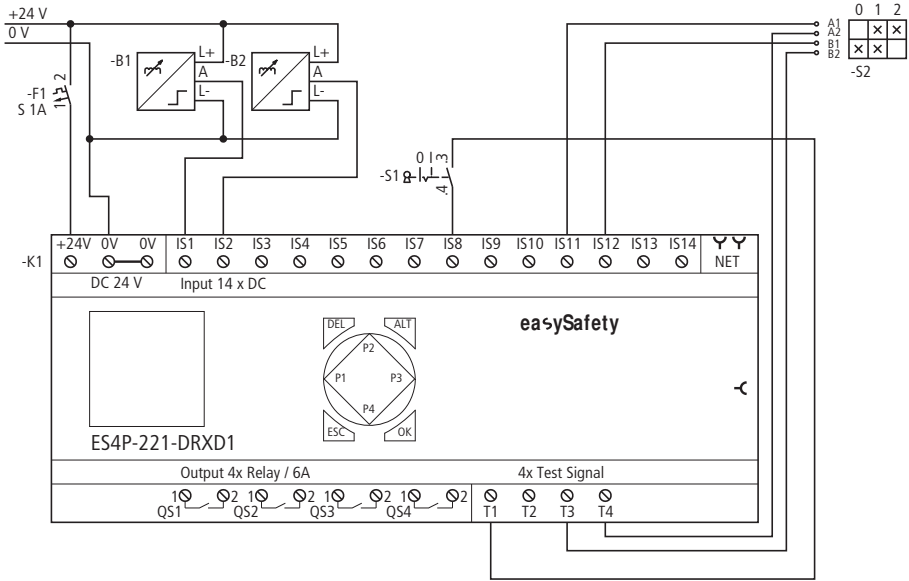

Figure 196: Foot switch example: Electrical circuit diagram

The circuit diagram in easySafety has only five rungs:

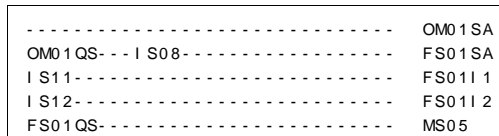

Figure 197: Foot switch example: Circuit diagram in easySafety

The enable contact of the overspeed monitoring function block OM01QS and the key switch S1 at IS08 switch coil FS01SA. The test signals T3 and T4 supply the foot switch S11 connected to the device terminals IS12 and IS2.

```

FS01 NEN *** *
      *** 2CH
>ED 3.0 min
    
```

The parameters for the enable stay in the default setting, you set the number of channels to 2 (2CH) and the maximum permissible enable time to 3.0 minutes.

```

I S01 <- -
...
I S08 <- T1
...
I S11 <- T4
I S12 <- T3
I S14 <- -

```

The test signals for cross-circuit monitoring are assigned to the corresponding device inputs in the TEST SIGNALS menu.

The signal diagram of the function block for this application shows the dependence of the enable contact FS01QS on the status of coils FS01SA, FS01I1 and FS01I2 as well as the timeout of the enable time:

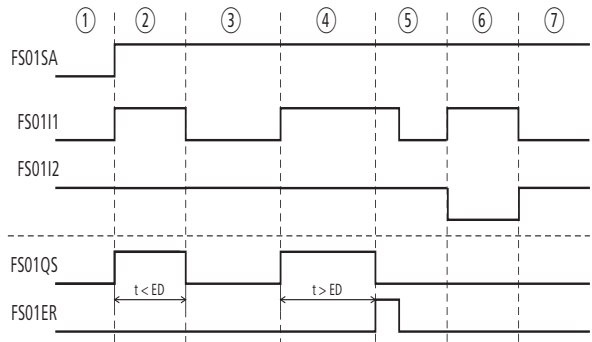

Figure 198: "Foot switch" example: signal diagram

Foot switch positions:

- ① The key switch is in the position for setting operation and the motor speed is slow. The foot switch can therefore be activated.
- ② Actuation of the foot switch (switch position 1). The enable time is less than the time set at ED.
- ③ Release of the foot switch, the enable at FS01QS is removed.
- ④ Actuation of the foot switch (switch position 1). The enable time is greater than the time set at ED. The enable at FS01QS is removed after the enable time has elapsed. The function block outputs an error signal via FS01ER.
- ⑤ Acknowledgement of the error signal by releasing the foot switch.
- ⑥ The foot switch is operated past the pressure point and engages (positively opening contact is activated).
- ⑦ After unlocking the foot switch with an additional pushbutton, the switch assumes its basic position again.

**LC, light curtain**

The light curtain function block is used for the safety-related monitoring of two-channel light curtains. These light curtains are used for example for:

- protection of hazardous locations.
- protection of hazardous areas.
- access protection.

easySafety allows the monitoring of up to 7 electro-sensitive protective equipment (ESPE) devices.

**Function block**

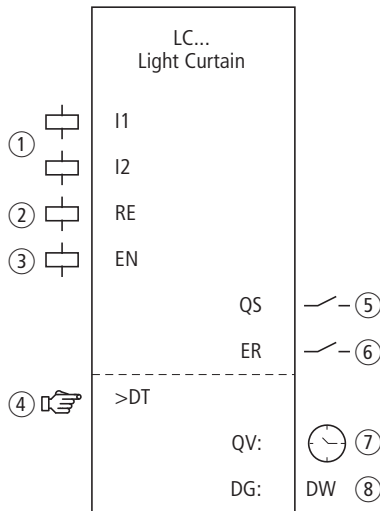

Figure 199: "Light curtain" function block

- ① Coils LC..I1 and LC..I2: OSSD (Output Signal Switching Device) monitoring, channels 1 and 2.  
Use only in safety circuit diagram.
- ② Coil LC..RE: Reset of the function block to Manual Start (MST) and Controlled Start (CST) modes and starting of normal operation.  
Use only in the safety circuit diagram.
- ③ Coil LC..EN: Selective activation or deactivation of the function block function (optional).  
Use either in the safety or standard circuit diagram.

- ④ Parameter LC..DT: Discrepancy time within which both coils LC..I1 and LC..I2 must have the same status. If the discrepancy time is not activated, the status change of an LC..I input coil will immediately cause a check whether the other reacted at the same time. If this does not occur, no enable is initiated and an error signal is output.  
Can be used as an adjustable constant.
- ⑤ Contact LC..QS: Closes when conditions for safe operation are fulfilled and enables the hazardous movement.  
Use only in the safety circuit diagram.
- ⑥ Contact LC..ER: Closes in the event of an error.  
Use in the safety and in standard circuit diagram.
- ⑦ Actual value output LC..QV: Indicates the current actual value of the discrepancy time.  
Indicated on the device or in easySoft-Safety.
- ⑧ Diagnostics output LC..DG: Provides information about the states of the function block.  
Evaluation only in the standard circuit diagram with the diagnostics function block DG.

### Wiring of the function block

Wire its coils LC..I1 and LC..I2 directly to the device terminals IS1 to IS14. Example of a light curtain function block:

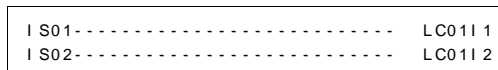

Figure 200: Wiring of input coils

You can associate the function block contact LC..QS directly with one or several safety device outputs, for example:

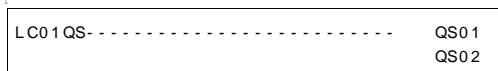

Figure 201: Wiring the enable contact to two device outputs

LC01	NEN	MST	*
	OFF	***	
>DT	3.0s		

### Parameters

When using the function block in the circuit diagram for the first time, use OK to automatically enter the general display of function block parameters, as shown in the figure on the left. Enter the function block settings here. The display contains the following elements:

LC01	Function block: light curtain, number 01
NEN	Enable: None required
MST	Operating mode: Manual start
OFF	Startup test: deactivated
>DT	Discrepancy time: 3.0 seconds

The parameters consist of the following:

**Enable**

The Enable parameter specifies whether an external function block enable is required. Further information can be found at section "Enable parameter, EN enable coil" on page 345.

Parameters	Function, parameterisation in the function block
EN	External enable required
NEN	No external enable required

This parameter is factory set to NEN, the function block is active without an external enable.

**Operating mode**

After easySafety has determined the conditions for safe operation, there are different kinds of restarts possible. They are described in greater detail as operating modes in section "Operating mode parameter, RE reset coil" on page 346.

Parameters	Function, parameterisation in the function block
AST	Automatic start, no manual restart
MST	Manual start
CST	Controlled start

The factory setting of this parameter is MST, Manual Start.



### Startup test

The protected area must be explicitly interrupted for the startup test and the Reset command initiated.

The startup test is carried out

- Every STOP-RUN change of the easySafety device.
- Every time the function block is deactivated and then activated with the EN enable coil.

The startup test is further described in section "Parameter SUT (Startup test)" on page 347.

Parameters	Function, parameterisation in the function block
OFF	No startup test required (default setting)
SUT	The startup test must be carried out

### Discrepancy time

The discrepancy time LC..DT can be set when activated for 2-channel light curtain monitoring.

Parameters	Function, parameterisation in the function block
>DT	OFF; 0.5 - 3.0 s; adjustable in increments of 0.5 s

easySafety is factory set with a discrepancy time of 3.0 s.

**Outputs**

The actual value output QV: Indicates the current actual value of the discrepancy time.

Diagnostics output DG: Provides information the states of the function block. It is evaluated in the standard circuit diagram e. g. with the diagnostics function block.

Parameters	Function, parameterisation in the function block
QV:	Actual value discrepancy time: Time
DG:	Diagnostics: double word a table 15

Table 15: Diagnostics-/Error codes

Status number		Plain text
Hexadecimal (0–F)	decimal (0-9)	
0000	0000	No Enable.
2001	8193	Enable issued; waiting for first (or only) input.
2002	8194	Waiting for second input.
2003	8195	Waiting for rising edge at Reset.
2004	8196	Waiting for falling edge at Reset.
2005	8197	Only one channel has been opened.
200E	8206	Waiting for inputs during startup testing.
8005	32773	Light curtain free (QS = 1).
F001	61441	Error: Discrepancy time expired.
F00B	61451	Error: Reset and inputs operated on function block startup.
F00E	61454	Error: Only one channel was opened and closed.

Further information on these outputs is provided in section "Common features", page 348.

### Coils and contacts

Function block coils initiate the functions of the function block and monitor the connected safety transmitters.

The contacts of a safety function block confirm the enable conditions present, selected operating modes or indicate errors.

#### Coils

Connect the function block coils LC..I1 and LC..I2 directly to the device terminals IS1 to IS14. The coils monitor the signal of the light curtain in the safety circuit diagram. The coils monitor the signal of the light curtain in the safety circuit diagram.

The Reset coil LC..RE resets the function block in Manual Start (MST) and Controlled Start (CST) operating modes and starts normal operation. It is used in the safety circuit diagram.

The function block is enabled either in the safety circuit diagram or in the standard circuit diagram via its enable coil LC..EN.

Coil	Function
LC. . I 1	OSSD channel 1
LC. . I 2	OSSD channel 2
LC. . RE	Reset
LC. . EN	Function block enable

**Contacts**

The LC..QS contact enables hazardous movement in the safety circuit diagram. It closes if the light curtain is not triggered.

If the LC..ER contact is wired in the standard and/or safety circuit diagram, it indicates the presence of an error by closing.

Contact	Function
LC..QS	Enable (contact closed -> light curtain not triggered)
LC..ER	Error message (contact closed -> Error)

**Memory requirement**

The LC function block requires 28 bytes of memory.

**Operation of the function block**

The ESPE triggers a switch off command when there is an intervention in the hazardous area, the coils LC..I1 and LC..I2 drop out. The enable contact LC..QS opens and the hazardous movement can be stopped.

**Error detection and acknowledgement**

The light curtain function block detects the timing out of the discrepancy time.

Error	Error acknowledgement
Timeout of discrepancy time DT	Dropping out of LC..I1 and LC..I2

General information on Errors and how the easySafety reacts to them is provided in section "Diagnostics using the ER contact" on page 622.

**Example 1 - Architecture of Category 2 according to EN ISO 13849-1**

Access control of an area with a 2-channel light curtain. Interruption of the light beam removes the enable, the re-enabling is automatic and without a manual startup after the protected area is vacated. The monitoring of the discrepancy time is set to 1 second and a startup test is to be carried out after every RUN/STOP change of the device.

**h**

Using suitable measures, ensure that any hazard is excluded after automatic re-enabling.

The enable contacts of the light curtain are connected to IS2 and IS3, the safety relay output QS1 switches contactor Q1 directly.

This looks as follows in the electrical circuit diagram:

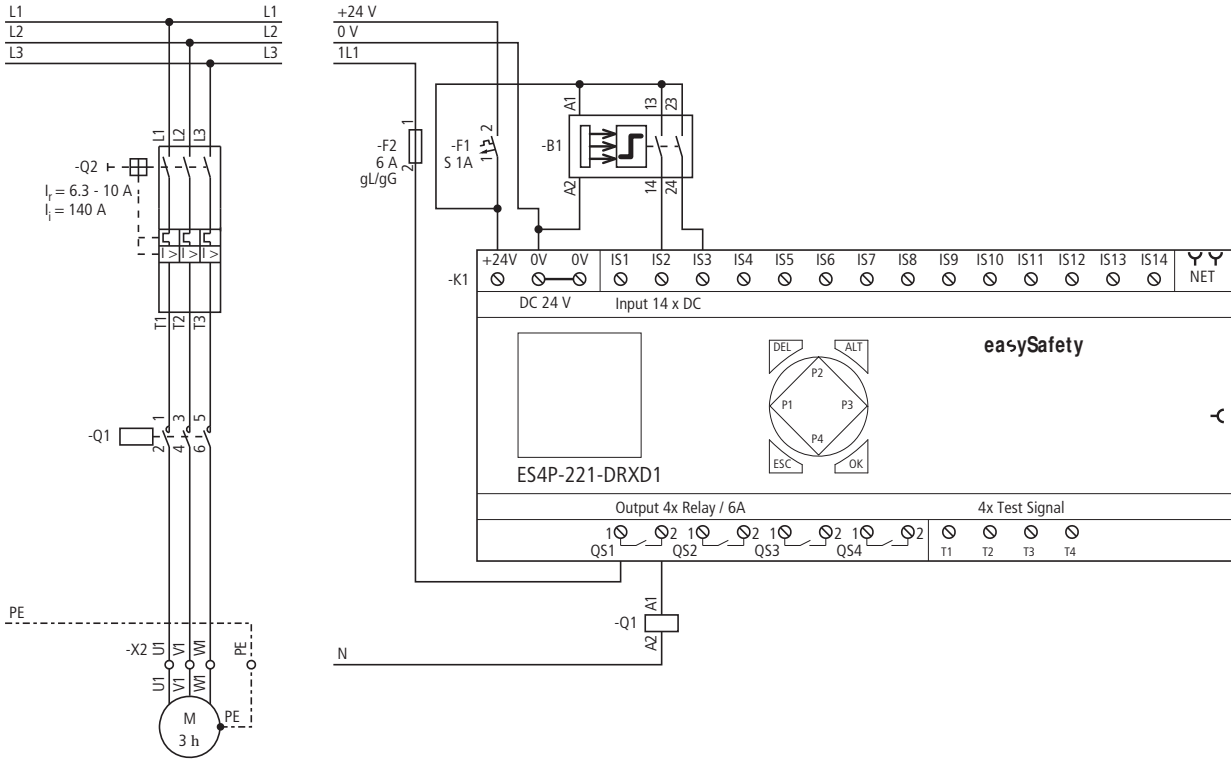

Figure 202: Light curtain example: Electrical circuit diagram

The circuit diagram in easySafety only has three rungs:

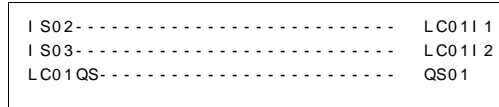

Figure 203: Example 1 "light curtain": Circuit diagram in easySafety

LC01	NEN	AST	*
	SUT	***	
>DT	1.0s		

The LC0111 and LC0112 input coils of the function block are directly associated with the device terminals IS2 and IS3, and the LC01QS enable contact switches the device output QS1.

The enable parameter stays in the default setting. The operating mode is changed to AST "Automatic Start". The SUT startup test is also activated.

The signal diagram for this application shows the dependence of the enable contact LC01QS on the status of coils LC0111 and LC0112:

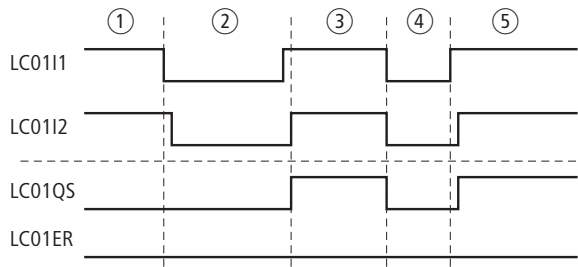

Figure 204: Example 1 Light curtain: signal diagram

- ① Light curtain free but startup test not yet completed
- ② Intervention, light curtain interrupted
- ③ Enable after leaving hazardous zone
- ④ Light curtain interrupted, enable removed
- ⑤ Light curtain clear, automatic enable via LC01QS

**Example 2 - Architecture of Category 4 according to EN ISO 13849-1**

Monitoring of a 2-channel light curtain and cross-circuit monitoring of its external wiring. The interruption of the light curtain triggers the protective function. After the area monitored by the light curtain is vacated, the controlled re-enabling is completed by actuating the Reset key switch. The discrepancy time is set to 0.5 seconds.

The make contacts of the light curtain -B1 are connected to the device terminals IS2 and IS3 and are supplied with test signals T3 and T4. Test signal T2 supplies the Reset button - S1 connected to IS6. The safety device outputs QS2 and QS4 switch the contactors Q1 and Q2 directly.

This looks as follows in the electrical circuit diagram:



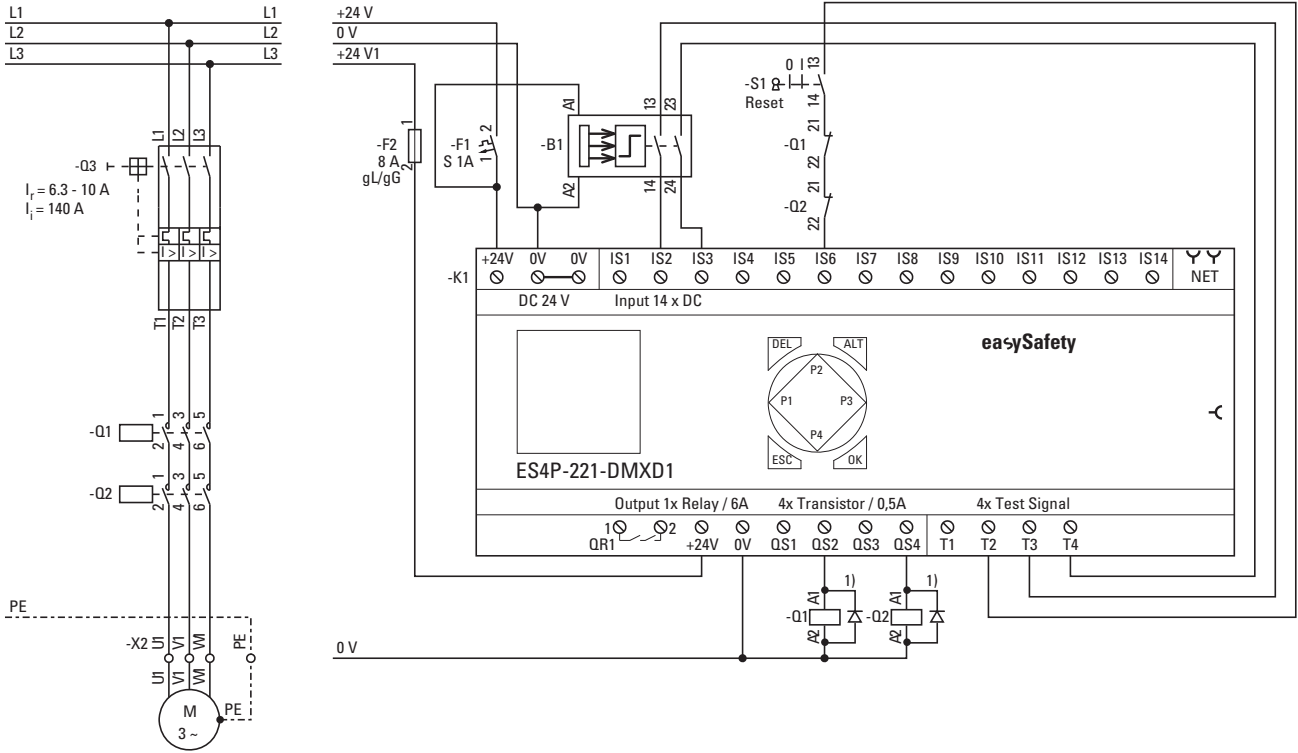

Figure 205: Light curtain example 2: Electrical circuit diagram  
 1) Use free-wheel diode suppressors for ES4P-221-DMX.. devices with device version 02 and 10

The circuit diagram in easySafety now has five rungs:

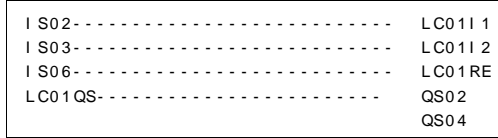

Figure 206: Example 2 "light curtain": Circuit diagram in easySafety

The LC0111 and LC0112 input coils are directly associated with the device terminals IS2 and IS3 and the Reset coil LC01RE is linked to IS06. The LC01QS enable contact switches the device outputs QS2 and QS4 directly.

```
LC01 NEN CST *
    ***
    >DT 0.5s
```

The enable parameter stays at NEN, i.e. no external enable. The operating mode is changed to CST "Controlled Start". The discrepancy time is set to 0.5 seconds.

```
I S01 <- -
I S02 <- T3
I S03 <- T4
...
```

The test signals for cross-circuit monitoring are assigned to the corresponding device inputs in the TEST SIGNALS menu.

```
I S06 <- T2
...
I S14 <- -
```

The signal diagram of the function block for this application shows:

- the dependence of the enable contact of LC01QS on the state of coils LC0111 and LC0112.
- the relationship between elapsed discrepancy time LC01DT and the error output LC01ER.
- the error acknowledgement with coils LC0111 and LC0112.
- the controlled re-enabling after the Reset coil LC01RE has dropped out.

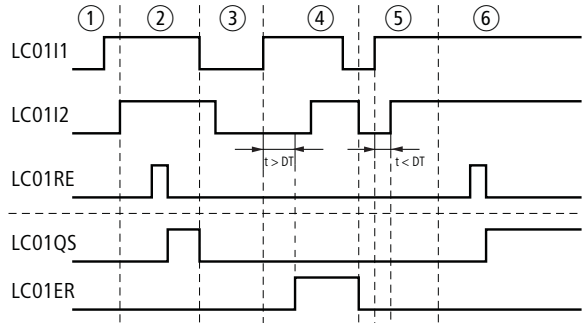

Figure 207: Example 2 Light curtain: Signal diagram

- ① Clearing of the light curtain.
- ② Monitored enabling at the Reset coil, LC01QS initiates enable.
- ③ Intervention in the protected area of the light curtain with the removal of the enable.
- ④ Discrepancy time exceeded when the light curtain is cleared again: error.
- ⑤ Acknowledgement of the error signal at LC01ER by repeated interruption of light curtain and renewed operation of LC0111 and LC0112 within the discrepancy time DT of 0.5 seconds.
- ⑥ Monitored re-enabling after the Reset coil has dropped out.

**LM, light curtain muting**

Muting is the process-related temporary suspension of a guard. This function is required if material has to be moved through the protected area of the guard without stopping the operating sequence.

**h**

The muting state must be removed immediately after the material has passed through and the guard must be restored to function. The muting system must therefore be able to distinguish between objects and persons.

The muting system must therefore be able to distinguish between objects and persons.

The Light curtain muting function block (LM) enables you to implement muting functions on your light curtain.

easySafety enables you to monitor up to 2 light curtains with muting sensors arranged in parallel and in series.

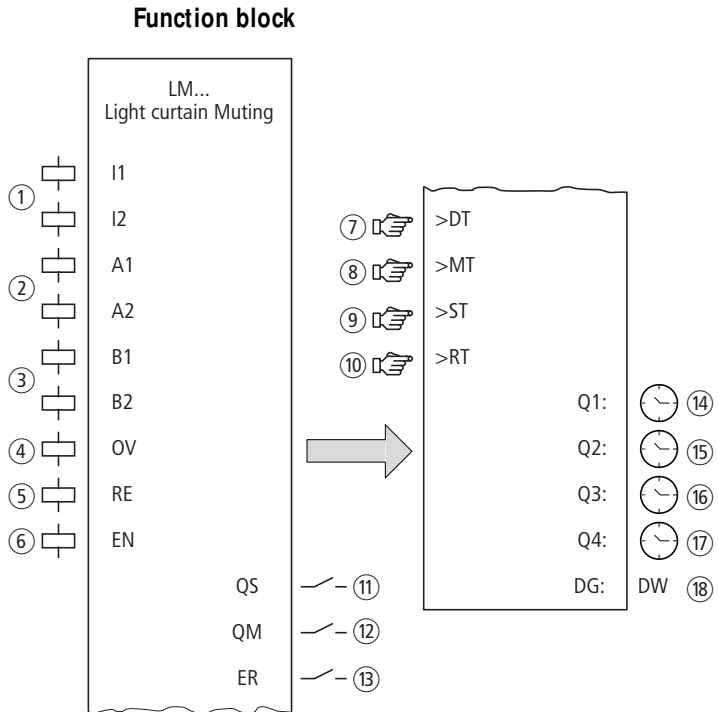

Figure 208: "Light curtain muting" function block

- ① Coils LM..I1 and LM..I2: Monitoring of the light curtain channels 1 and 2.  
Use only in the safety circuit diagram.
- ② Coils LM..A1 and LM..A2: Monitoring of muting sensors group A.  
Use only in the safety circuit diagram.
- ③ Coils LM..B1 and LM..B2: Monitoring of the muting sensors group B.  
Use only in the safety circuit diagram.
- ④ Coil LM..OV: Override, bridging of the protective function in muting mode.  
Use only in the safety circuit diagram.
- ⑤ Coil LM..RE: Reset of the function block to Manual Start (MST) and Controlled Start (CST) modes and starting of normal operation.  
Use only in the safety circuit diagram.

- ⑥ Coil LM..EN: Selective activation or deactivation of the function block function (optional).  
Use either in the safety or standard circuit diagram.
- ⑦ Parameter LM..DT: Discrepancy time within which both coils LM..I1 and LM..I2 must have picked up (logic 1).  
Can be used as an adjustable constant.
- ⑧ Parameter LM..MT: Muting time, the maximum bridging time between entering and vacating the hazardous zone.  
Can be used as an adjustable constant.
- ⑨ Parameter LM..ST: Synchronisation time within which the muting coils within a group must reach the same state in order to allow or end the bridging of the safety function in a controlled manner.  
Can be used as an adjustable constant.
- ⑩ Parameter LM..RT: Duration of override release time, within which the protection function can be bridged during muting in the event of a fault.  
Can be used as an adjustable constant.
- ⑪ Contact LM..QS: Closes when conditions for safe operation are fulfilled and enables the hazardous movement.  
Use only in the safety circuit diagram.
- ⑫ Contact LM..QM: Closes during muting.  
Use only in the safety circuit diagram.
- ⑬ Contact LM..ER: Closes in the event of an error.  
Use in the safety and in standard circuit diagram.
- ⑭ Actual value output LM..Q1: Indicates the current actual value of the discrepancy time.  
Indicated on the device or in easySoft-Safety.
- ⑮ Actual value output LM..Q2: Indicates the current actual value of the muting time.  
Indicated on the device or in easySoft-Safety.
- ⑯ Actual value output LM..Q3: Indicates the current actual value of the synchronisation time.  
Indicated on the device or in easySoft-Safety.
- ⑰ Actual value output LM..Q4: Indicates the current actual value of the override release time.  
Indicated on the device or in easySoft-Safety.
- ⑱ Diagnostics output LM..DG: Provides information about the states of the function block.  
Evaluation only in the standard circuit diagram with the diagnostics function block DG.

### Wiring of the function block

Wire its coils I1 and I2, A1 and A2, as well as B1 and B2 directly to the device terminals IS1 to IS14. Example of an LM function block:

I S01	-----	L M0 1 I 1
I S02	-----	L M0 1 I 2
I S03	-----	L M0 1 A1
I S04	-----	L M0 1 A2
I S05	-----	L M0 1 B1
I S06	-----	L M0 1 B2
I S07	-----	L M0 1 OV

Figure 209: easySafety circuit diagram with light curtain muting function block.

You can associate the function block contacts QM and QS directly with one or several safety device outputs, for example:

L M0 1 QM	-----	QS1
L M0 1 QS	-----	QS2
		QS3

Figure 210: Wiring the enable contact to two device outputs.

LM01	NEN	MST	*
	OFF	2P	
>DT	3.0S		
>MT	OFF		
>ST	4.0s		
>RT	OFF		

**Parameters**

When using the function block in the circuit diagram for the first time, use OK to automatically enter the general display of function block parameters, as shown in the figure on the left. Enter the function block settings here. The display contains the following elements:

LM01	Function block: Light curtain muting, no. 01
NEN	Enable: None required
MST	Operating mode: Manual start
OFF	Startup test: deactivated
2P	Muting sensors: <ul style="list-style-type: none"> <li>• 2 sensors, A1 and A2</li> <li>• P, parallel muting</li> </ul>
>DT	Discrepancy time: 3.0 seconds
>MT	Muting time: OFF
>ST	Synchronisation time: 4.0 seconds
>RT	Override release time: OFF

The parameters consist of the following:

**Enable**

The Enable parameter specifies whether an external function block enable is required. Further information can be found at section "Enable parameter, EN enable coil" on page 345.

Parameters	Function, parameterisation in the function block
EN	External enable required
NEN	No external enable required

This parameter is factory set to NEN, the function block is active without an external enable.



### Operating mode

After easySafety has determined the conditions for safe operation, there are different kinds of restarts possible. They are described in greater detail as operating modes in section "Operating mode parameter, RE reset coil" on page 346.

Parameters	Function, parameterisation in the function block
AST	Automatic start, no manual restart
MST	Manual start
CST	Controlled start

The factory setting of this parameter is MST, Manual Start.

### Startup test

The protected area must be explicitly interrupted for the startup test and the Reset command initiated. The startup test is further described in section "Parameter SUT (Startup test)" on page 347.

Parameters	Function, parameterisation in the function block
OFF	No startup test required (default setting)
SUT	The startup test must be carried out

### Muting sensors

The setting of this parameter depends on the arrangement of muting sensors and the muting procedure selected.

Parameters	Function, parameterisation in the function block
2P	Use of 2 sensors A1 and A2 for parallel muting, crossed arrangement (default settings)
2S	Use of 2 sensors A1 and A2 for serial muting, adjacent arrangement
4P	Use of 4 sensors A1, A2 and B1, B2 for parallel muting, opposing arrangement
4S	Use of 4 sensors A1, A2 and B1, B2 for sequential muting, adjacent arrangement

### Discrepancy time

The discrepancy time LM..DT can be set when activated for 2-channel light curtain monitoring.

Parameters	Function, parameterisation in the function block
>DT	OFF; 0.5 - 3.0 s; adjustable in increments of 0.5 s

easySafety is factory set with a discrepancy time of 3.0 s.

### Muting time

The muting time MT is the maximum bridging time between entering and vacating the hazardous zone.

Parameters	Function, parameterisation in the function block
>MT	OFF; 1 - 600 s; adjustable in increments of g?s

easySafety is factory set with the muting time of OFF (corresponds to infinitely).

### Synchronisation time

The synchronisation time ST is the time within which the muting coils within a group must reach the same state in order to allow or end the bridging of the safety function in a controlled manner.

Parameters	Function, parameterisation in the function block
>ST	OFF; 0.5 - 10.0 s; adjustable in increments of g?B s

easySafety is factory set with a synchronisation time of 4.0 s. The sensors A1 and A2 must therefore reach the same state within the 4.0 s. If this is not the case, the function block signals an error at LM..ER and the enable at LM..QS is removed.

**Override release time**

The override release time is the time within which the protection function can be bridged during muting in the event of a fault.

Parameters	Function, parameterisation in the function block
>RT	OFF; 1 s - 600 s; adjustable in increments of 0.1 s

easySafety is delivered with the override release time set to OFF by default (i.e. override release is not activated, see section "Override" on page 427).

**Outputs**

The actual value outputs Q1: to Q4: indicate the actual value of the monitored times:

- Q1 = discrepancy time DT.
- Q2 = muting time MT.
- Q3 = synchronisation time ST.
- Q4 = override release time RT.

Diagnostics output DG: Provides information the states of the function block. It is evaluated in the standard circuit diagram e. g. with the diagnostics function block.

Parameters	Function, parameterisation in the function block
Q1 :	Actual value discrepancy time: Time
Q2:	Actual muting time: Time
Q3:	Synchronisation time actual value: Time
Q4 :	Override release time actual value: Time
DG:	Diagnostics: double word table 16

Tabelle 16: Diagnostics-/Error codes

Status number		Plain text
Hexadecimal (0–F)	decimal (0-9)	
0000	0000	No Enable.
2001	8193	Enable issued; waiting for first (or only) input.
2002	8194	Waiting for second input.
2003	8195	Waiting for rising edge at Reset.
2004	8196	Waiting for falling edge at Reset.
2005	8197	Only one channel has been opened.
200E	8206	Waiting for inputs during startup testing.
8006	32774	Light curtain free (QS = 1).
8011 - 8037	32785 - 32823	States within the muting sequence: The flow sequence of the safety function block's muting states depends on the input signals and the muting procedure. The current states within the muting sequence can be evaluated based on the diagnostic codes.
8018	32792	Muting state Move Clear.
F001	61441	Error: Discrepancy time expired.
F003	61443	Error: Muting duration exceeded.
F004	61444	Error: Synchronization duration exceeded.
F005	61445	Error: Clearing duration exceeded.
F00B	61451	Error: Reset and inputs operated on function block startup.
F00E	61454	Error: Only one channel was opened and closed.
F019	61465	Error: Implausible processing sequence.
F01A	61466	Error: Muting sequence completed, light curtain not free.
F01B	61467	Error: Clearing completed; light curtain or sensors not free.

More information on the diagnostics output DG: is provided in section "Common features", page 348.

**Coils and contacts**

Function block coils initiate the functions of the function block and monitor the connected safety transmitters.

The contacts of a safety function block confirm the enable conditions present, selected operating modes or indicate errors.

**Coils**

Connect the following function block coils directly to the device terminals IS1 to IS14. Monitor the signal of the connected encoders in the safety circuit diagram.

- LM..I1 to LM..I2.
- LM..A1 to LM..A2.
- LM..B1 to LM..B2.

Coil	Function
LM . I 1	Light barrier, channel 1
LM . I 2	Light curtain, channel 2
LM . A 1	Muting sensor group A, sensor 1
LM . A 2	Muting sensor group A, sensor 2
LM . B 1	Muting sensor group B, sensor 1
LM . B 2	Muting sensor group B, sensor 2

The override coil LM..OV makes it possible to bridge the protective function during the muting in the safety circuit diagram, in order to rectify a fault.

Coil	Function
LM . OV	Override

The override function is limited by the override release time LM..RT.

The Reset coil LM..RE resets the function block in Manual Start (MST) and Controlled Start (CST) operating modes and starts normal operation. It is used in the safety circuit diagram.

The function block is enabled either in the safety circuit diagram or in the standard circuit diagram via its enable coil LM..EN.

<b>Coil</b>	<b>Function</b>
L.M. . RE	Reset
L.M. . EN	Function block enable

**Contacts**

The LM..QS contact enables hazardous movement in the safety circuit diagram. It closes if the hazardous area is not interrupted and stays closed while muting is correctly activated.

The signal contact LM.:QM likewise indicates the muting operation in the safety circuit diagram. The safety function is suspended by muting and is monitored by the muting sensors. The signal contact closes in order to indicate muting operation, i.e. that the safety function has been removed.

If the LM..ER contact is wired in the standard and/or safety circuit diagram, it indicates the presence of an error by closing.

Contact	Function
LM . QS	Enable (contact closed -> light curtain not triggered)
LM . QM	Muting: The safety function is suspended by muting
LM . ER	Error message (contact closed -> Error)

**Memory requirement**

The LM function block requires 56 bytes of memory.

**Operation of the function block**

Access is generally controlled by an ESPE device (electro-sensitive protective equipment) which consists of light barriers, light grids and light curtains.

The ESPE triggers a switchoff command when there is an intervention in the hazardous area, the channel coils LM..I1 and LM..I2 drop out. The enable contact LM..QS opens and the hazardous movement can be stopped.



### Muting

Unlike the LC light curtain function block, this function block also has the muting function. The muting function makes it possible to automatically bridge the safety function of the EPSE for a specific time. This enables goods to be transported through the hazardous area of the guard without stopping the cyclical operation.

Two muting sensors fitted in front of the protected area of the EPSE initiate the bridging:

- They detect entry into the protected area.
- You start the monitoring of the maximum permissible muting time while the muting contact QM of the function block indicates the activated muting function.

Optical pushbutton actuators or inductive proximity sensors are used as muting sensors.

j

#### Danger!

Ensure suitable measures for preventing danger to persons or objects during muting.

If the sensors determine that the transported material has not yet left the muting area (muting area including light curtain) after the maximum permissible muting time MT has elapsed, the LM..QS enable contact opens and the LM..ER error contact closes.

j

#### Danger!

The bridging must also be removed automatically after the material has passed through and the guard must be restored to function.

Various sensor arrangements can be used. Parallel and sequential muting are possible.

h

The illustrations below of light curtain muting the basic sensor arrangements.

For the exact arrangement of the sensors for each application, see the (preliminary) standard IEC/TS 62046 02/2008.

The easySafety is adapted to the different muting arrangements using the Muting sensors parameter described below.

The following figure is used to illustrate the different muting procedures used. This shows the top view of a conveyor belt which moves the transported material through a light curtain into the hazardous area.

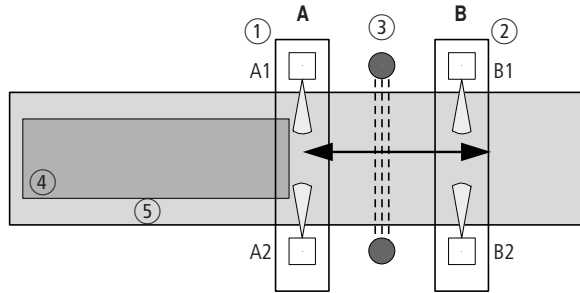

Figure 211: Light curtain muting: Example figure, the arrows point to the possible direction of motion of the transported material that is supported by the muting process.

- ① Group A of the muting sensors, consisting of A1 and A2
- ② Group B of the muting sensors, consisting of B1 and B2
- ③ Light curtain
- ④ Transported material
- ⑤ Conveyor belt

**Muting sensors parameter: 2P**

Retro-reflective sensors can be used to initiate muting if they are suitably arranged. For this the sensor beams must be arranged so that their crossing point is located behind the light curtain.

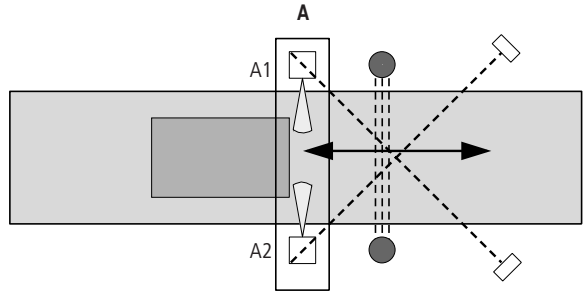

Figure 212: Light curtain for muting: Parallel muting with 2 muting sensors

h

The sensors and the reflectors must be arranged so that they remain triggered until the transported material has left the protected area.

Both directions of motion are permissible and therefore any signal sequence is possible.

The sensors are connected to function block coils LM..A1 and LM..A2.

The synchronization time ST must be set very low as this muting process requires the parallel triggering of both muting sensors A1 and A2.

**Muting sensors parameter: 4P**

Parallel muting with 4 sensors enables a second group of muting sensors to detect the end of the movement of the transported good.

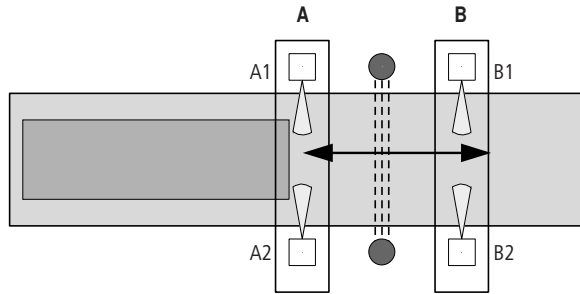

Figure 213: Light curtain for muting: Parallel muting with 4 muting sensors

h

The sensors of group B must be arranged so that they remain triggered as long as the sensors of group A at the entry are still triggered. As soon as the sensor group A and the light curtain no longer detect an interruption in the protected area, the sensor group B reactivates the protective function of the light curtain (with motion direction A to B) after the muting area is vacated.

As soon as the sensor group A and the light curtain no longer detect an interruption in the protected area, the sensor group B reactivates the protective function of the light curtain (with motion direction A to B) after the muting area is vacated.

Both directions of motion are permissible and there any signal sequence is possible:

- Group A -> Group B
- Group B -> Group A

Sensor group A is connected to function block coils LM..A1 and LM..A2. Sensor group B is connected to function block coils LM..B1 and LM..B2.

The synchronization time  $ST$  must be set very low as this muting process requires the parallel triggering of both muting sensors A1 and A2 as well as B1 and B2.

### Muting sensors parameter: 2S

Sequential muting with 2 sensors enables a group of muting sensors arranged in sequence to detect the start of the movement of the transported goods.

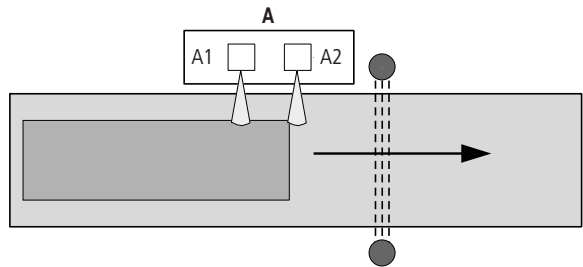

Figure 214: Light curtain for muting: Sequential muting with 2 muting sensors

With this signal sequence, only the direction of motion A1 - > A2 is permissible:

The sensors are connected to the function block coils LM..A1 and LM..A2.

The protective function of the light curtain is reactivated after the transported material leaves the light curtain.

**Muting sensors parameter: 4S**

Sequential muting with 4 sensors enables two groups of muting sensors arranged in sequence to detect the start and the end of the movement of the transported goods.

Muting is initiated after the second sensor A2 or B1 picks up.

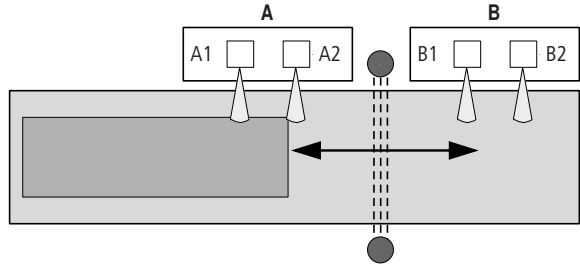

Figure 215: Light curtain for muting: Sequential muting with 4 muting sensors

The bridging of the safety function must be initiated and then terminated in a specific order.

Both directions of motion are permissible with these signal sequences:

- A1-A2-B1-B2
- B2-B1-A2-A1

Sensor group A is connected to the LM..A1 and LM..A2 function block coils. Sensor group B is connected to the LM..B1 and LM..B2 function block coils.

The sensors of group B must be arranged so that they remain triggered as long as the sensors of group A at the entry are still triggered. As soon as the sensor group A and the light curtain no longer detect an interruption in the protected area, the sensor group B reactivates the protective function of the light curtain (with motion direction A to B) after the muting area is vacated.

**Override**

The override function enables you to bridge the muting sequence and thus clear, for example, the jammed transported material. Override is only possible if the function block LM has detected an error in the muting sequence. In order to activate override, you must set a maximum override release time RT. When the coil LM..OV picks up, the muting sequence is bridged and the enable is initiated at function block output LM..QS. The override is terminated after the override release time RT has elapsed or the coil LM..OV is opened. The override function is also terminated if the muting system detects the default state. This is the case when no muting sensors have been triggered and the light curtain is clear.

If the function block has the Manual Start (MST) or Controlled Start (CST) operating mode, the LM..RE reset input must be activated in order to reset the function block and start uninterrupted operation.

**h**

Install the override pushbutton in a location with a clear view of the hazardous zone.

The override function must only be executed by authorised personnel and should only be activated using something like a key switch.

**Error detection and acknowledgement**

The light curtain muting function block detects the timing out of the following times:

- Discrepancy time DT.
- Synchronisation time ST.
- Muting time MT.
- Override release time RT.

The function block also monitors the order of the muting sequence for sequential muting.

Error	Error acknowledgement
Timeout of discrepancy time DT	Dropping out of LM..I1 and LM..I2
Timeout of the synchronisation time ST.	Dropping out of LM..A1 and LM..A2 as well as LM..B1 and LM..B2
Timeout of the muting time MT	Dropping out of LM..I1 and LM..I2, LM..A1 and LM..A2 as well as LM..B1 and LM..B2
Timeout of the override release time RT	Dropping out of LM..I1 and LM..I2, LM..A1 and LM..A2 as well as LM..B1 and LM..B2
Muting sequence	Dropping out of LM..OV or picking up of LM..RE

General information on Errors and how the easySafety reacts to them is provided in section "Diagnostics using the ER contact" on page 622.

**Example - Architecture of Category 4 according to EN ISO 13849-1**

Access control of an area with a 2-channel light curtain. The protective function is bridged automatically by 2 muting sensors arranged in parallel and reactivated when the transported material has passed through.



An override button enables the conveyed material to be moved out of the hazardous area during muting in the event of damage.

MST (Manual Start) operating mode is selected in order to avoid an automatic enabling after the occurrence of faults or the interruptions in the light curtain.

Cross-circuit monitoring of the external wiring is implemented using the test signals and also the monitoring of the following times are set.

- Discrepancy time DT: 0.5 s.
- Muting time MT: 60 s.
- Synchronization time ST: 1 s.
- Override release time RT: 60 s.

The connections are implemented as follows:

- Enable contacts of the B1 light curtain to the device terminals IS5 and IS6.
- Muting sensors B2 and B3 to IS10 and IS14.
- Override key switch to IS1.
- The feedback loop including Reset button to IS2.

The safety relay outputs QS1 and QS2 switch contactors Q2 and Q3 directly.

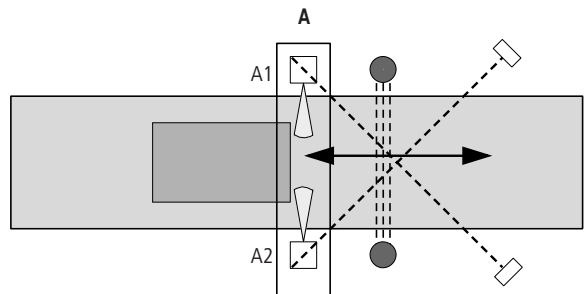

Figure 216: Light curtain for muting: Parallel muting with 2 muting sensors

This looks as follows in the electrical circuit diagram:

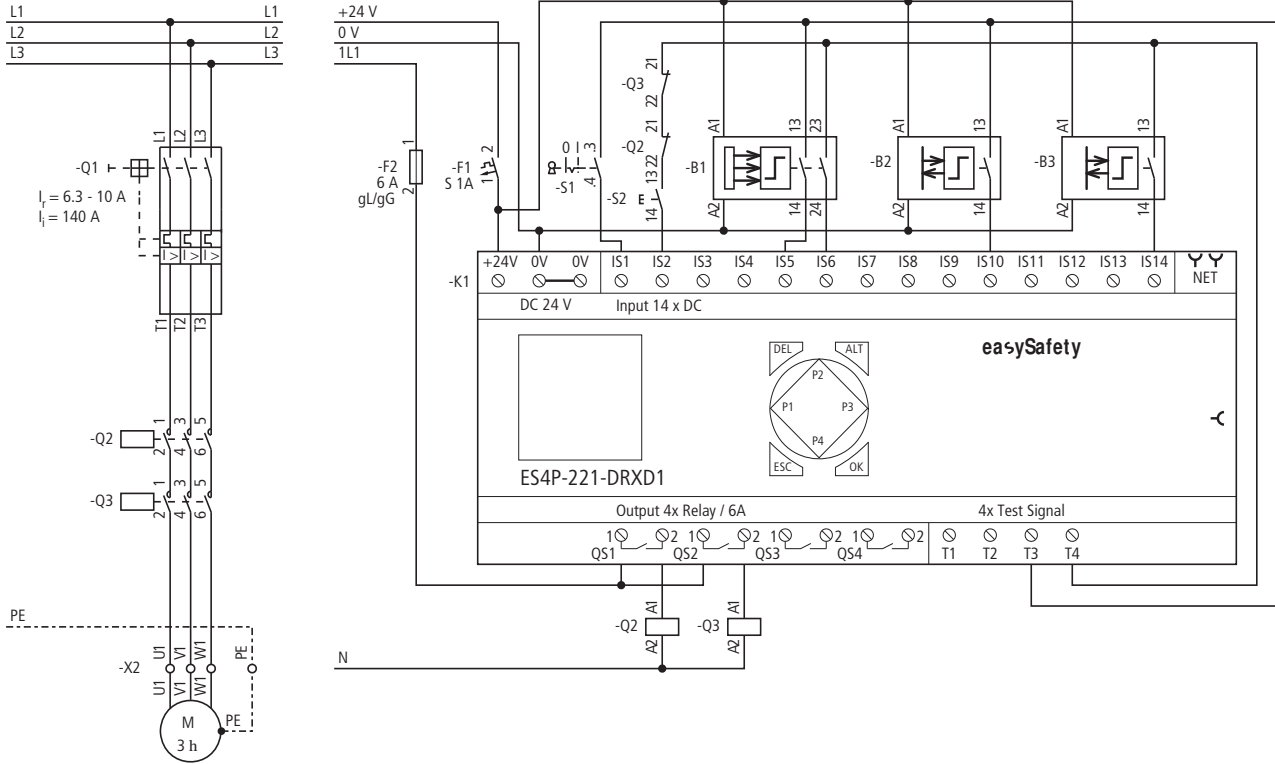

Figure 217: Light curtain muting example: Electrical circuit diagram

The circuit diagram in easySafety has eight rungs:

I S05	-----	LM01 I 1
I S06	-----	LM01 I 2
I S10	-----	LM01 A1
I S14	-----	LM01 A2
I S01	-----	LM01 OV
I S02	-----	LM01 RE
LM01 QS	-----	QS0 1
		QS0 2

Figure 218: Example of light curtain muting: Circuit diagram in easySafety.

The input coils LM01I1 and LM01I2 of the function block are associated directly with the device terminals IS5 and IS6, the muting coils LM01A1 and LM01A2 with the terminals IS10 and IS14, the override coil LM01OV with IS1 and the Reset coil with the input IS02.

The enable contact LM01QS switches the device outputs QS1 and QS2.

LM01	NEN	MST	*
	OFF	2P	
>DT	0.5s		
>MT	60s		
>ST	1.0s		
>RT	60s		

The default parameters for the enable (NEN), muting process (2P) and the operating mode (MST) are retained. A startup test is also not required (OFF).

I S01	<-	T3	*
I S02	<-	T4	*
...			
I S05	<-	T3	*
I S06	<-	T4	*
...			
I S10	<-	T3	*
...			
I S14	<-	T4	*

The test signals for cross-circuit monitoring are assigned to the corresponding device inputs in the TEST SIGNALS menu.

The signal diagram for this application shows the dependence of the enable contact LM01QS on the status of the following coils:

- LM01I1 and LM01I2.
- LM01A1 and LM01A2.
- LM01RE.
- LM01OV.

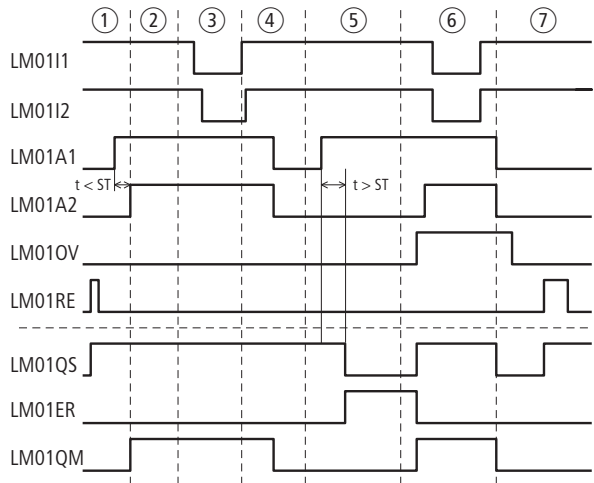

Figure 219: Example of "Light curtain muting": Signal diagram for normal operation

- ① Manual Start and subsequent entry of the transported material in the muting area.
- ② Muting mode active.
- ③ Transported material interrupts light curtain.
- ④ Transported material leaves the light curtain and muting area. The exit of the transported material ends the muting mode.
- ⑤ The subsequent transported material tilts so that the status of the second muting sensor A2 cannot follow the status change of the muting sensor A1 within the synchronisation time ST. The enable at LM01QS is removed and the error is signalled via LM01ER.
- ⑥ Actuating the override key switch (LM01OV) enables the transported material to be moved through the light curtain. If the default state is reached again (light curtain and muting sensors clear), the enable at LS01QS is removed again as MST (Manual Start) is set.
- ⑦ Actuating the Reset button causes the LM01RE coil to pick up and restarts the LM01 function block. As the light curtain is not interrupted and there is no error, the enable is issued via LS01QS.

**OM, Maximum speed monitoring**

The function block is used for the safety-related speed monitoring of a motor or a shaft. If the set maximum speed is exceeded, the function block removes the enable for the drive and outputs an error signal at the same time.

The function block always operates with 2 rotary encoders. easySafety allows the monitoring of 2 maximum speeds on the same shaft or motor for different operating modes.

**Function block**

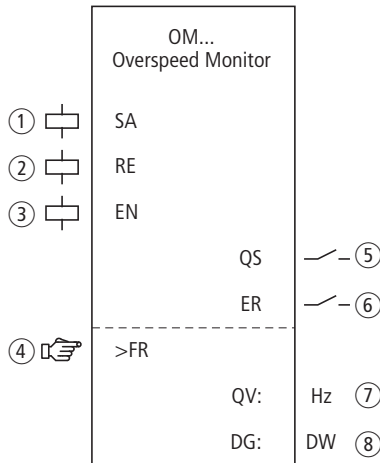

Figure 220: Overspeed monitoring function block

- ① Coil OM..SA: safety activation of the function block. Use only in the safety circuit diagram.
- ② Coil OM..RE: Reset of the function block to Manual Start (MST) and Controlled Start (CST) modes and starting of normal operation. Use only in the safety circuit diagram.
- ③ Coil OM..EN: Selective activation or deactivation of the function block function. Use either in the safety or standard circuit diagram.
- ④ Parameter OM..FR: Maximum permissible rotation frequency. Can be used as an adjustable constant.
- ⑤ Contact OM..QS: Closes if the rotation frequency is less than the permissible frequency and enables the hazardous move-

ment.

Use only in the safety circuit diagram.

- ⑥ Contact OM..ER: Closes in the event of an error. Use in the safety and in standard circuit diagram. In a fault scenario the contact TS..QS stays open.
- ⑦ Actual value output OM..QV: Indicates the current actual value of the rotation frequency. Indicated on the device or in easySoft-Safety.
- ⑧ Diagnostics output OM..DG: Provides information about the states of the function block. Evaluation only in the standard circuit diagram with the diagnostics function block DG.

### Wiring of the function block

The relay uses different coils and contacts.

h

<p>The speed input coils of the OM function block are connected directly to device inputs IS1 and IS2 so that the rotary encoder is always connected here and no function block wiring is required.</p>
---

j

#### **Danger!**

The device always regards two static High signals at easySafetydevice inputs IS1 and IS2 as standstill, so that the OM..QS contact is not switched off.

This behaviour applies also for two static Low signals if these are applied to IS1/IS2 immediately after a change into operating state RUN until the first Low-High edge is detected.

h

<p>easySafety enables the simultaneous operation of both function blocks for zero speed and overspeed speed monitoring using the same sensors.</p>
--

The coils OM..RE and OM..SA can be associated within the safety circuit diagram. The following is an example of an overspeed monitoring function block.

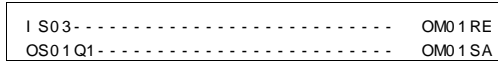

Figure 221: Wiring of input coils

You can associate the enabling contact OM..QS directly for further processing, for example:

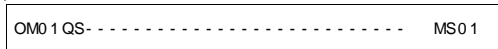

Figure 222: Wiring of the enable contact to a safety marker for further processing in the safety circuit diagram



**Warning!**

When using function block OM, make sure that it enables the dangerous motion through its contact OM..QS.

Keep in mind that the easySafety device can change into its safe state when the dangerous motion is already enabled before the easySafety device is switched on.

**Parameters**

When using the function block in the circuit diagram for the first time, use OK to automatically enter the general display of function block parameters, as shown in the figure on the left. Enter the function block settings here. The display example contains the following elements: MST

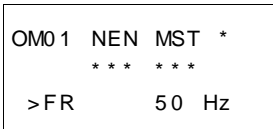

OM0 1	Function block, overspeed monitoring, number 01
NEN	Enable: None required
MST	Operating mode: Manual start
>FR	Maximum rotation frequency: 50 Hz

The parameters consist of the following:

**Enable**

You use the enable coil OM..EN to activate or deactivate the function block as required. Further information can be found at section "Enable parameter, EN enable coil" on page 345.



Parameters	Function, parameterisation in the function block
EN	External enable required
NEN	No external enable required

This parameter is factory set to NEN, the function block is active without an external enable.

### Operating mode

After easySafety has determined the conditions for safe operation, there are different kinds of restarts possible. They are described in greater detail as operating modes in a chapter "Operating mode parameter, RE reset coil" on page 346.

Parameters	Function, parameterisation in the function block
AST	Automatic start, no manual restart
MST	Manual start
CST	Controlled start

The factory setting of this parameter is MST, Manual Start.

### Maximum rotation frequency

The maximum permissible rotation frequency FR is the frequency that the motor must not exceed. The setpoint for this frequency is entered as parameter >FR, the actual value is determined via the two encoders on the motor.

Parameters	Function, parameterisation in the function block
>FR	50 - 1000 Hz; adjustable in increments of g1 Hz (default setting = 50 Hz)



#### Warning!

The highest permissible rotating frequency at device inputs IS1 and IS2 is 1000 Hz.

Higher frequencies are not reliably detected by the easySafety device and can cause malfunction.

It is the engineer's responsibility to ensure that no higher rotary frequencies can be applied at IS1 and IS2.

### Outputs

The actual value output QV: Indicates the actual value of the rotation frequency. The maximum frequency is 3 %.

Diagnostics output DG: Provides information the states of the function block. It is evaluated in the standard circuit diagram e. g. with the diagnostics function block.

Parameters	Function, parameterisation in the function block
QV:	Actual rotation frequency: 50 - 1 000 Hz
DG:	Diagnostics: double word a table 17

Table 17: Diagnostics-/Error codes

Status number		Plain text
Hexadecimal (0–F)	decimal (0-9)	
0000	0000	No Enable.
2001	8193	Enable issued, waiting for safe activation via input OM..SA.
2003	8195	Waiting for rising edge at Reset.
2004	8196	Waiting for falling edge at Reset.
2009	8201	Measurement started.
8007	32775	Maximum speed not exceeded (QS = 1).
F007	61447	Error: Both channels on Low (open circuit).
F008	61448	Error: Frequency measuring range exceeded (>1200 Hz).
F009	61449	Error: Different input frequencies.
F00A	61450	Error: No pulses on one channel.
F013	61459	Error: Reset operated on function block startup.

Further information on these outputs is provided in section "Common features", page 348.

### Coils and contacts

Function block coils initiate the functions of the function block and monitor the connected safety transmitters.

The contacts of a safety function block confirm the enable conditions present, selected operating modes or indicate errors.

#### Coils

The OM..SA function block coil is used to start the monitoring function of the function block.

Associate the coil here for example with the enable contact of another safety function block.

The Reset coil OM..RE resets the function block in Manual Start (MST) and Controlled Start (CST) operating modes and starts normal operation. It is used in the safety circuit diagram.

The function block is enabled either in the safety circuit diagram or in the standard circuit diagram via its enable coil OM..EN.

Coil	Function
OM. . SA	Safety activation of the function block
OM. . RE	Reset
OM. . EN	Function block enable

### Contacts

The OM..QS contact in the safety circuit diagram enables hazardous movement. It is closed for as long as the measured frequency is less than the entered maximum frequency.

If the OM..ER contact is wired in the standard and/or safety circuit diagram, it indicates the presence of an error by closing.

Contact	Function
OM. . QS	Enable (contact closed -> maximum speed not exceeded)
OM. . ER	Error message (contact closed -> Error)

### Memory requirement

The OM function block requires 36 bytes of memory.

### Operation of the function block

A gear or cam wheel and two PNP sensors are required to measure the rotation frequency.

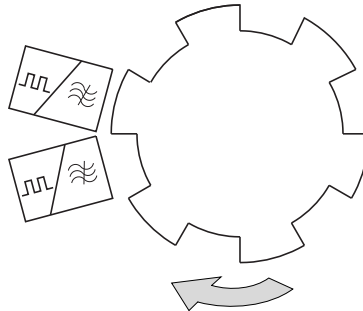

Figure 223: Overspeed monitoring, rotation frequency

h

The proximity switches must be arranged so that at least one sensor is actuated at any time, in order for the function block to detect that the encoders are connected and that they are installed correctly.

- A wire break is indicated and the enable is removed if both sensors have not switched.

- If both function block coils receive a synchronous signal, a fault is indicated and the enable may possibly be removed.
- After each change of easySafety into operating state RUN the two sensors can issue the same level without a fault message being generated. In operating mode AST contact OM..QS is closed at that time.  
Only when the first edge is detected at one of the two inputs IS1/IS2 does the function block signal a fault if both sensors output the same level. Contact OM..QS then opens.

The speed is determined by the frequency measured. The frequency depends on the number of pulses per rotation:

With a gear wheel on a shaft with 6 cams and a maximum speed of 800 rpm, the maximum rotation frequency FR is calculated using the formula:

$$f \text{ [Hz]} = C * n[\text{rpm}] / 60$$

$$80 \text{ Hz} = 6 * 800 [\text{rpm}] / 60$$

If the set frequency is exceeded, the enable for the drive is removed. The enable is issued again in the following cases:

- After the reset coil OM..RE has picked up at zero speed.
- In AST - automatic restart without manual restart - if the actual rotation speed is below the set rotation speed by at least 5 %.

**j****Danger!**

In order to avoid unexpected restarts, use Manual Start (MST) or Controlled Start (CST) operating mode.

**Error detection and acknowledgement**

The function block detects when the maximum permissible rotation frequency is exceeded, as well as the failure of the sensors at device terminals IS1 and IS2.

h

The maximum permissible rotation frequency on device inputs IS1 and IS2 is 1000 Hz.

<b>Error</b>	<b>Error acknowledgement</b>
Maximum permissible rotation frequency exceeded	Drop out of coil OM..SA for activation of the safety function block
Failure of sensors	Drop out of coil OM..SA for activation of the safety function block

General information on Errors and how the easySafety reacts to them is provided in section "Diagnostics using the ER contact" on page 622.

**Example - Architecture of Category 2 according to EN ISO 13849-1**

The speed of a shaft is required to not exceed 400 rpm. Two inductive proximity switches in conjunction with a cam disk with 10 cams on the shaft record the speed.

The function block is required to remove the enable for driving the shaft as soon as the maximum speed is exceeded. The drive must stand still before the function block allows a re-enabling via OM01RE. This is implemented using the ZM zero monitoring function block. The wiring of the ZM function block is not explained further in this example. Further information can be found in section "ZM, zero (standstill) monitoring", page 509.

The connections are implemented as follows in this example:

- The feedback loop including Reset button to IS9.
- Both sensors to IS1 and IS2.
- Enabling contact OM..QS switches device output QS1.
- The coil SA is always active for the safe activation in this example.

The rotation frequency to be set on easySafety:  
 $10 \times 400 \text{ rpm} / 60 = 66 \text{ Hz}$ .

This looks as follows in the electrical circuit diagram:



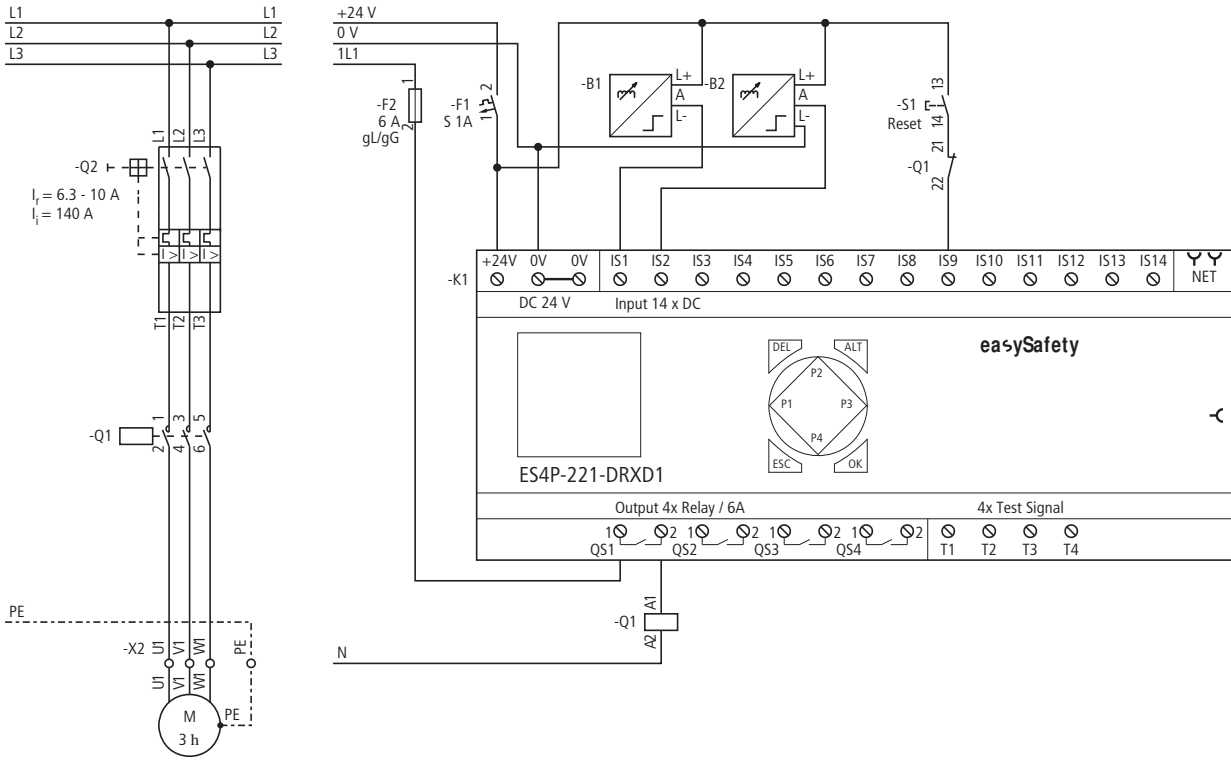

Figure 224: Example of overspeed monitoring: Electrical circuit diagram

The circuit diagram in easySafety has only five rungs:

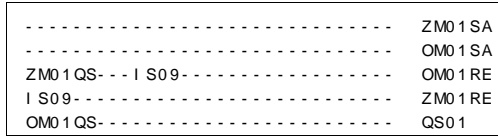
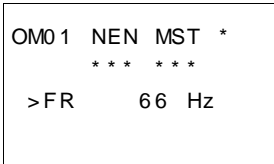

Figure 225: Example of overspeed monitoring: Electrical circuit diagram in easySafety

The coil OM01SA is always active in this example. The function block is often activated via mode selector switch, (a section "OS, operating mode selector", page 449). You do not have to wire function block inputs OM0111 and OM0112, since these are automatically connected to device inputs IS01 and IS02. The safe Enable contact OM01QS switches off device output QS1 – and with it contactor Q1 – when the maximum speed is exceeded. Re-enabling is implemented via OM01RE if the motor stands still (ZM01QS = 1) and the Reset button is actuated (IS09 = 1).



The enable parameter as well as the operating mode are kept in the default setting and the maximum rotation frequency is 66 Hz.

The signal diagram of the function block for this application shows the dependence of the enable contact OM01QS on the measured frequency at the function block coils I1 and I2:

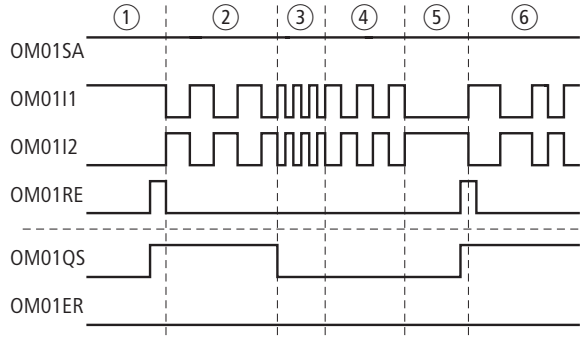

Figure 226: Example of overspeed monitoring: signal diagram

- ① The overspeed monitoring function block OM01 is activated via OM01SA, speed monitoring is started via the Reset input OM01RE. As the motor is standing still, the function block issues the enable via OM01QS (OM01QS = 1).
- ② The motor rotates below the parameterized limit frequency of 66 Hz.
- ③ The motor rotation exceeds the limit frequency. The OM01 function block removes its enable (OM01QS = 0).
- ④ The motor gets slower and runs down.
- ⑤ The motor is at a standstill. The function block OM01 is reset via the Reset input and issues its enable again, OM01QS closes.
- ⑥ The motor rotates below the maximum rotation frequency.

The following graph shows the time requirements for the signals to IS1 and IS2 with the resulting valid and invalid states at the maximum rotational frequency of 1000 Hz:

- Valid signal level and time interval for a start.
- Minimum time for the Low signal at IS1 and IS2.
- Minimum time interval between the edge changes at IS1 and IS2.

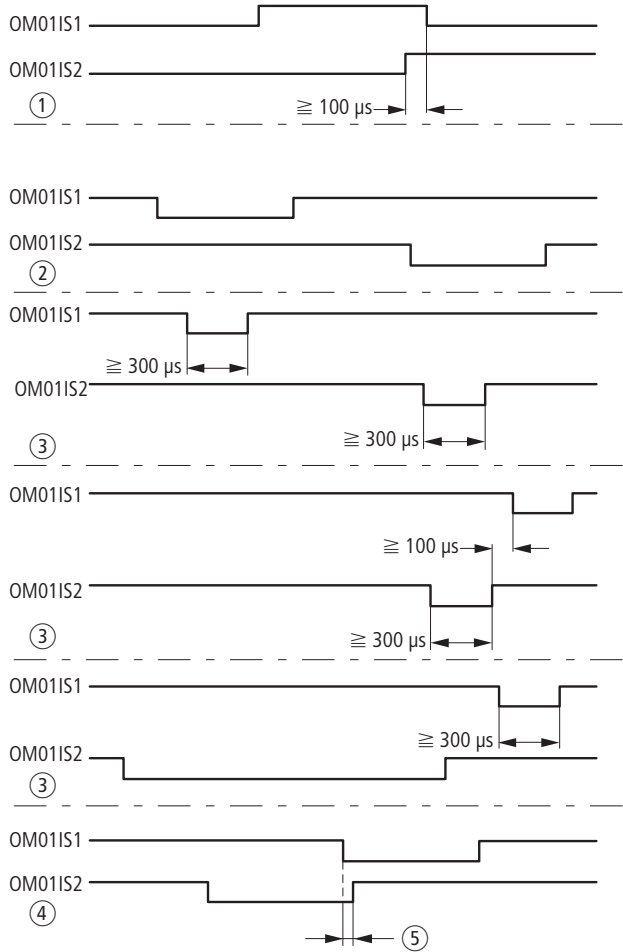

Figure 227: Time behaviour of the signals at IS1/IS2

- ① Start with the first edge
- ② Optimum duration and intervals
- ③ Permissible duration and intervals
- ④ Non-permissible intervals lead to overlapping
- ⑤ Overlap

**OS, operating mode selector switch**

The function block is used for the selection of up to five modes. It enables the safe selection and safe acceptance of a mode.

easySafety allows the safe use of up to 7 mode selector switches.

**Function block**

Figure 228: Operating mode switch function block

- ① Coils OS..I1 to OS..I5: Monitoring of operating mode switch. Use only in the safety circuit diagram.
- ② Coil OS..UL: Allowing the mode change. Use only in the safety circuit diagram.
- ③ Coil OS..EN: Selective activation or deactivation of the function block function. Use either in the safety or standard circuit diagram.
- ④ Coil OS..SM: Allowing the mode change. Use either in the safety or standard circuit diagram.

- ⑤ Contacts OS..Q1 to Q5: Close on acceptance of the selected operating mode and enable it.  
Use only in the safety circuit diagram.
- ⑥ Contact OS..ER: Closes in the event of an error.  
Use in the safety and in standard circuit diagram.
- ⑦ Diagnostics output OS..DG: Provides information about the states of the function block.  
Evaluation only in the standard circuit diagram with the diagnostics function block DG.

**Wiring of the function block**

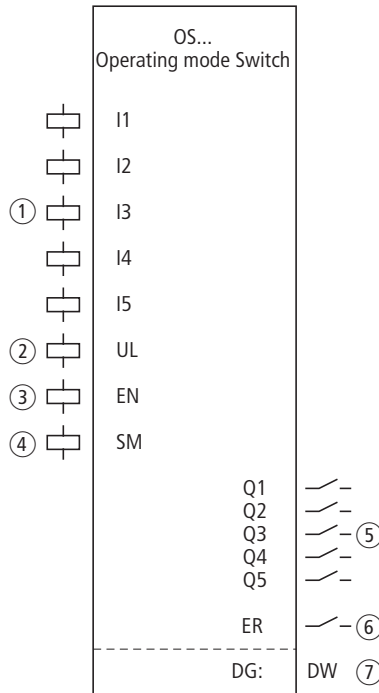
Wire its coils OS..I1 to OS..I5 directly with the device terminals IS1 to IS14. Example of an operating mode switch with 5 switch positions:

I S01	-----	OS011 1
I S02	-----	OS011 2
I S03	-----	OS011 3
I S04	-----	OS011 4
I S05	-----	OS011 5
I S06	-----	OS01 SM
I S07	-----	OS01 UL

Figure 229: Wiring of input coils

The function block contacts OS..Q1 to OS..Q5 can be used for the further processing in the circuit diagram. Example:

OS01 Q1	-----	MS0 1
OS01 Q2	-----	MS0 2
OS01 Q3	-----	MS0 3
OS01 Q4	-----	MS0 4
OS01 Q5	-----	MS0 5

Figure 230: Wiring the contacts of the operating mode switch to safety markers

OS0 1	NEN	*** *
	***	***

### Parameters

When using the function block in the circuit diagram for the first time, use OK to automatically enter the general display of function block parameters, as shown in the figure on the left. Enter the function block settings here. The display contains the following elements:

OS0 1	Function block: operating mode switch, number 01
NEN	Enable: none required

The parameters consist of the following:

### Enable

The Enable parameter specifies whether an external function block enable is required. Further information can be found at section "Enable parameter, EN enable coil" on page 345.

Parameters	Function, parameterisation in the function block
EN	External enable required
NEN	No external enable required

This parameter is factory set to NEN, the function block is active without an external enable.

**Output**

Diagnostics output DG: Provides information the states of the function block. It is evaluated in the standard circuit diagram e. g. with the diagnostics function block.

Parameters	Function, parameterisation in the function block
DG:	Diagnostics: double worda table 18

Table 18: Diagnostics-/Error codes

Status number		Plain text
Hexadecimal (0–F)	decimal (0-9)	
0000	0000	No Enable.
200A	8202	Operating mode can be selected.
802A	32810	Operating mode 1 selected (Q1 = 1).
802B	32811	Operating mode 2 selected (Q2 = 1).
802C	32812	Operating mode 3 selected (Q3 = 1).
802D	32813	Operating mode 4 selected (Q4 = 1).
802E	32814	Operating mode 5 selected (Q5 = 1).
803A	32826	Operating mode 1 fixed (Q1 = 1).
803B	32827	Operating mode 2 fixed (Q2 = 1).
803C	32828	Operating mode 3 fixed (Q3 = 1).
803D	32829	Operating mode 4 fixed (Q4 = 1).
803E	32830	Operating mode 5 fixed (Q5 = 1).
F014	61460	Error: More than one operating mode selected at the same time.
F015	61461	Error: No operating mode selected.

Further information on this output is provided in section "Common features", page 348.



### Coils and contacts

Function block coils initiate the functions of the function block and monitor the connected safety transmitters.

The contacts of a safety function block confirm the enable conditions present, selected operating modes or indicate errors.

#### Coils

Connect the function block coils OS..I1 and OS..I5 directly to the device terminals IS1 to IS14. The coils monitor the signal of the light curtain in the safety circuit diagram.

If the coil OS..UL picks up in the safety circuit diagram, the selection of the new operating mode is accepted with function block coil OS..SM.

The function block is enabled either in the safety circuit diagram or in the standard circuit diagram via its enable coil OS..EN.

If the coil OS..UL picks up in the safety circuit diagram, the function block accepts the new operating mode with a rising edge at the function block coil OS..SM. If it has not picked up, the coil OS..SM has no function.

Coil	Function
OS..I1 to OS..I5	Operating mode 1 to 5
OS..UL	Enable for operating mode change
OS..EN	Function block enable
OS..SM	Acceptance of the new operating mode

**Contacts**

In the safety circuit diagram, the contacts OS..Q1 to OS..Q5 transfer the operating mode. They close according to the operating mode. Example: if operating mode 2 is selected, the contact OS..Q2 closes.

If the OS..ER contact is wired in the standard and/or safety circuit diagram, it indicates the presence of an error by closing.

Contact	Function
OS..Q1 To OS..Q5	Operating mode: 1 to 5
OS..ER	Error message (contact closed -> Error)

**Memory requirement**

The OS function block requires 24 bytes of memory.

**Operation of the function block**

The input coils OS..I1 to OS..I5 accept the switch positions of the operating mode switch.

The enable coil OS..UL allows a safe change of the operating mode.

If the mode change is permitted, the new operating mode is accepted as soon as the acceptance coil OS..SM picks up.

**Error detection and acknowledgement**

The operating mode switch function block detects the simultaneous selection of more than one operating mode.

Error	Error acknowledgement
Simultaneous selection of more than one operating mode	Selection of only one operating mode, allow operating mode change via OS..UL and pick up of the acceptance coil OS..SM

General information on Errors and how the easySafety reacts to them is provided in section "Diagnostics using the ER contact" on page 622.

**Example**

Use of the operating mode switch with 3 switch positions. Actuating a key switch allows the operating mode change. The actual change is implemented with an acceptance button.

The connections are implemented as follows:

- Operating mode switch S1 at device terminals IS1 to IS3.
- Key switch S2 at device terminal IS6.
- Acceptance button S3 at device terminal IS8.

This looks as follows in the electrical circuit diagram:

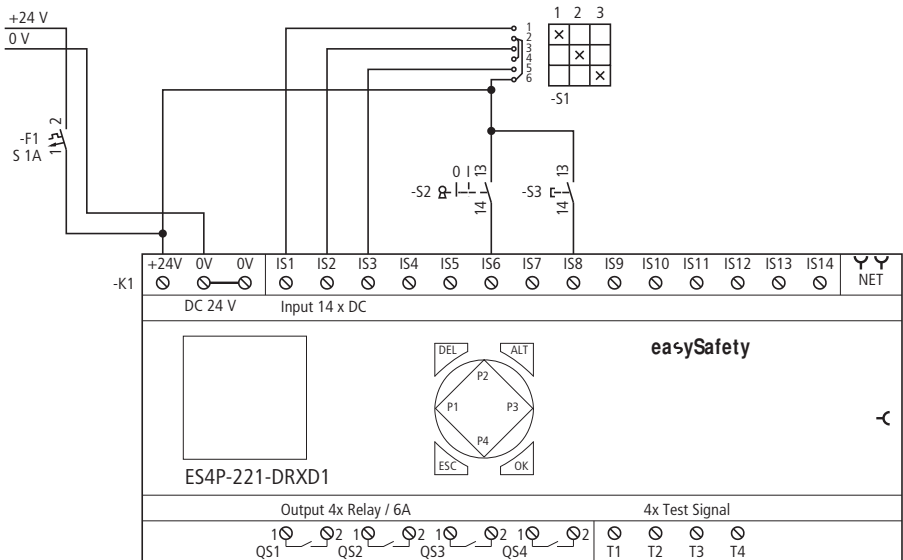

Figure 231: "Operating mode switch" example: electrical circuit diagram

The circuit diagram in easySafety has eight rungs:

I S01	-----	OS01 I 1
I S02	-----	OS01 I 2
I S03	-----	OS01 I 3
I S06	-----	OS01 UL
I S08	-----	OS01 SM
OS01 Q1	-----	MS01
OS01 Q2	-----	MS02
OS01 Q3	-----	MS03

Figure 232: "Operating mode switch" example: circuit diagram in easySafety

The input coils OS01I1 to I3 of the function block are directly associated with the device terminals IS1 to IS3. The coil OS01UL that allows the operating mode change and the coil OS01SM that carries out the operating mode change are likewise connected to the corresponding input terminals of the device.

The operating mode contacts OS01Q1 to OS01Q3 are further processed in the safety circuit diagram via safety markers.

The enable parameter stays in the default setting.

OS01	NEN	***	*
	***	***	

The timing diagram of the function block for this application shows the dependence of operating mode contacts OS01Q1 and OS01Q2 on the state of coils OS01I1 and OS01I2, the enable coil OS01UL and the acceptance coil OS01SM.

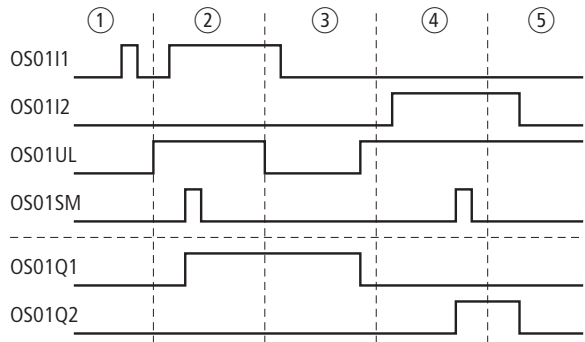

Figure 233: "Operating mode switch" example: timing diagram

- ① Operating mode 1 is not accepted as no enable is present via OS01UL for the operating mode change.
- ② Enable for operating mode change present via OS01UL. Operating mode 1 is accepted with a rising edge at OS01SM.
- ③ Enable for operating mode change is removed. As operating mode 1 was active at this point, this mode is retained until the enable is present again at OS01UL. If the coil OS01UL picks up, the function block detects that no operating mode is selected and the closed contact OS01Q1 opens.
- ④ Acceptance of operating mode 2.
- ⑤ Operating mode 2 is taken again, since an enable for the operating mode is present via OS01UL

**SE, Start element**

The Start element function block is used for the safe starting of an application by an external start button or for adding a start condition in the safety circuit diagram with the Manual Start (MST) or Controlled Start (CST) modes.

easySafety allows the monitoring of up to 16 starting circuits.

**Function block**

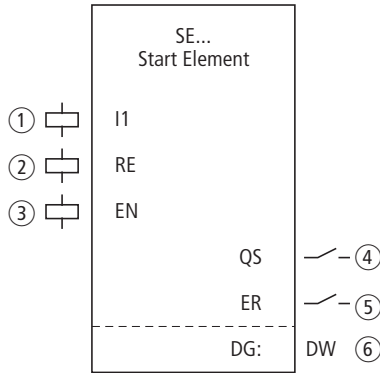

Figure 234: Start element function block

- ① Coil SE..I1: acceptance of the Start command.  
Use only in the safety circuit diagram.
- ② Coil SE..RE: Reset of the function block in the Manual Start (MST) and Controlled Start (CST) mode and the starting of normal operation.  
Use only in the safety circuit diagram.
- ③ Coil SE..EN: Selective activation or deactivation of the function block.  
Use either in the safety or standard circuit diagram.
- ④ Contact SE..QS: Closes when the corresponding Start command is present at coil SE..I1 and starts an additional action in the safety circuit diagram.  
Use only in the safety circuit diagram.
- ⑤ Contact SE..ER: Closes in the event of an error.  
Use in the safety and in standard circuit diagram.
- ⑥ Diagnostics output SE..DG: Provides information on the states of the function block.

Evaluation only in the standard circuit diagram with the diagnostics function block DG.

### Wiring of the function block

The function block uses various different coils and contacts.

The coils SE..I1 and SE..RE can be addressed via any possible association. Example of a start element function block:

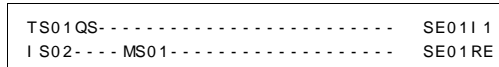

Figure 235: Wiring of input coils

The SE..QS function block can likewise be used in the safety circuit diagram, for example:

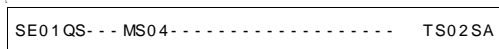

Figure 236: Wiring of the enable contact



### Parameters

When using the function block in the circuit diagram for the first time, use OK to automatically enter the general display of function block parameters, as shown in the figure on the left. Enter the function block settings here. The display contains the following elements:

SE01	Function block: Start element, number 01
NEN	Enable: none required
MST	Operating mode: Manual start

The parameters consist of the following:

**Enable**

The Enable parameter specifies whether an external function block enable is required. Further information can be found at section “Enable parameter, EN enable coil” on page 345.

Parameters	Function, parameterisation in the function block
EN	External enable required
NEN	No external enable required

This parameter is factory set to NEN, the function block is active without an external enable.

**Operating mode**

After easySafety has determined the conditions for safe operation, there are different kinds of restarts possible. They are described in greater detail as operating modes in chapter “Operating mode parameter, RE reset coil” on page 346.

Parameters	Function, parameterisation in the function block
MST	Manual start
CST	Controlled start

This parameter is factory set to MST, manual start.

**Output**

Diagnostics output DG: Provides information the states of the function block. It is evaluated in the standard circuit diagram e. g. with the diagnostics function block.

Parameters	Function, parameterisation in the function block
DG:	Diagnostics: double word a table 19

Table 19: Diagnostics-/Error codes



Status number		Plain text
Hexadecimal (0–F)	decimal (0-9)	
0000	0000	No Enable.
2001	8193	Enable issued; waiting for input.
2003	8195	Waiting for rising edge at Reset.
2004	8196	Waiting for falling edge at Reset.
8008	32776	Start signal triggered (QS = 1).
F00B	61451	Error: Reset operated on function block startup.

Further information on this output is provided in section “Common features”, page 348.

### Coils and contacts

Function block coils initiate the functions of the function block and monitor the connected safety transmitters.

The contacts of a safety function block confirm the enable conditions present, selected operating modes or indicate errors.

#### Coils

You close the function block coil SE..I1 directly at the device terminals IS1 to IS14 or associate it with any combination of contacts and connections. The coil initiates the safe start command in the safety circuit diagram.

The actual Start command is triggered via the Reset coil SE..RE. If you have set MST (Manual Start), the coil responds to the rising edge. If you have selected CST (Controlled Start), the coil responds to the falling edge. Use the coils only in the safety circuit diagram.

The function of the function block is enabled either in the safety or in the standard circuit diagram with its enable coil SE..EN.

Coil	Function
SE..I1	Start element channel 1
SE..RE	Reset
SE..EN	Enable, see above

**Contacts**

In the safety circuit diagram, the contact SE..QS closes if the coil ES..I1 is addressed (logic 1) and the Start command is received via the Reset coil. The contact SE..QS stays closed until the coil SE..I1 is energized.

If you wire the contact SE..ER in the standard and/or safety circuit diagram, it indicates the presence of an error by closing.

Contact	Function
SE..QS	Enable (contact closed -> Safety Start command triggered)
SE..ER	Error message (contact closed -> Error)

**Memory requirement**

The function block SE requires 20 bytes of memory.

**Operation of the function block**

The Start command at coil SE..I1 prepares the function block for enabling the safe start of an application. Depending on the operating mode selected, the Start enable is triggered by the Reset coil SE..RE.

### Error detection and acknowledgement

If the function block detects on activation that the coils I1 and RE are already activated, it prevents the automatic start.

Error	Error acknowledgement
I1 and RE are on when the function block is activated	Dropping out of I1 and RE

General information on Errors and how easySafety reacts to them, is provided in the section "Diagnostics using the ER contact" on page 622.

### Example

Safe Start enable if the marker contact MS03 is closed and the external Reset button S1 (connected at the device input IS2). The Start enable should only be initiated when the Reset button is released and is retained until the MS03 marker contact is closed. The Start enable is assigned to the marker coil MS10 for further processing.

The circuit diagram in easySafety only has three rungs:

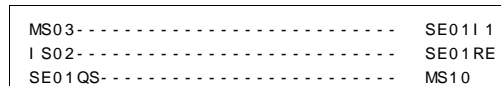

Figure 237: Example of Start element circuit diagram in easySafety

The safety marker MS03 is associated with the function block coil SE011 and the Reset coil SE01RE with the device terminal IS2. The enable contact SE01QS of the function block switches the marker MS10 directly.



The enable parameter stays in the default setting, the mode is set to CST (Controlled Start).

The signal diagram of the function block for this application shows the dependence of the enable contact SE01QS on the status of coil SE0111 and SE01RE:

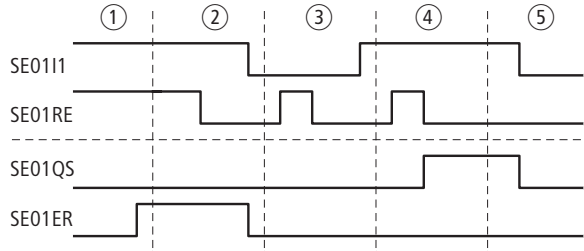

Figure 238: Example Start element signal diagram

- ① Coils SE0111 and SE01RE have picked up. Error contact SE01ER closes when the function block is activated.
- ② Dropping off of coils SE0111 and SE01RE. Error contact SE01ER opens.
- ③ Coil SE0111 dropped out. Controlled enable when SE01RE drops out has no effect on the contact SE01QS.
- ④ Coil SE0111 picked up. Drop out of SE01ER initiates the controlled enable.
- ⑤ Coil SE0111 drops, enable contact SE01QS opens.

**SG, safety gate (optionally  
with guard locking)**

The safety gate function block is used for the safety-related monitoring of safety gates. These gates are required to prevent persons from entering a hazardous area. For this a 1-channel or 2-channel switch monitors the position of the gate as well as the guard if required.

easySafety allows the monitoring of up to fourteen 1-channel safety gate circuits or seven 2-channel safety gate circuits.

**Function block**

Figure 239: Function block: "Safety gate"

- ① Coils SG..I1 to SG..I3: connection of the monitoring switches:
  - I1 and I2: Gate switch channel 1 and 2
  - I3: Guard locking
 Use only in the safety circuit diagram.
- ② Coil SG..RE: Reset of the function block in the Manual Start (MST) and Controlled Start (CST) modes and the starting of normal operation.
 Use only in the safety circuit diagram.

- ③ Coil SG..EN: Selective activation or deactivation of the function block.  
Use either in the safety or standard circuit diagram.
- ④ Parameter SG..DT: Discrepancy time within which both coils SG..I1 and SG..I2 must have picked up.  
Use with 2-channel safety gate monitoring as adjustable constant
- ⑤ Contact SG..QS: Closes when conditions for normal operation present and enables the hazardous movement.  
Use only in the safety circuit diagram.
- ⑥ Contact SG..ER: Closes in the event of an error.  
Use in the safety and in standard circuit diagram.
- ⑦ Actual value output DG..QV: Indicates the current actual value of the discrepancy time.  
Indicated on the device or in easySoft-Safety.
- ⑧ Diagnostics output SG..DG: Provides information on the states of the function block.  
Evaluation only in the standard circuit diagram with the diagnostics function block DG.

### Wiring of the function block

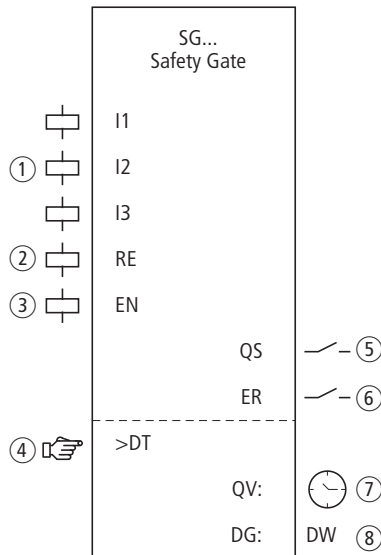
Wire its coils I1 to I3 directly to the device terminals IS1 to IS14, for example:

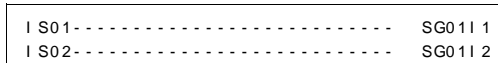

Figure 240: Wiring of input coils for 2-channel safety gate monitoring

You can associate the function block contact QS directly with one or several of the safety device outputs, for example:

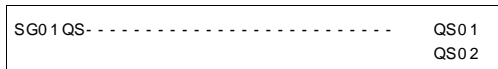

Figure 241: Wiring the enable contact to two device outputs

SG01	NEN	MST	*
	OFF	2CH	
>DT	3.0s		

### Parameters

When using the function block in the circuit diagram for the first time, use OK to automatically enter the general display of function block parameters, as shown in the figure on the left. Enter the function block settings here. The display contains the following elements:

SG01	Function block: Safety gate, No. 01
NEN	Enable: none required
MST	Operating mode: Manual start
OFF	Startup test: deactivated
2CH	Evaluation: 2-channel
>DT	Discrepancy time: 3.0 seconds

The parameters consist of the following:

#### Enable

The enable coil SG..EN allows the selective activation or deactivation of the function block. Further information can be found at section "Enable parameter, EN enable coil" on page 345.

Parameters	Function, parameterisation in the function block
EN	External enable required
NEN	No external enable required

This parameter is factory set to NEN, the function block is active without an external enable.

#### Operating mode

After easySafety has determined the conditions for safe operation, there are different kinds of restarts possible. They are described in greater detail as operating modes in chapter "Operating mode parameter, RE reset coil" on page 346.

Parameters	Function, parameterisation in the function block
MST	Manual start
CST	Controlled start
AST	Automatic start, no manual restart

The factory setting of this parameter is MST, Manual Start.

**Startup test**

The safety gates must be opened explicitly for the startup test. The startup test is carried out

- with every STOP-RUN change of easySafety or after
- each deactivation and subsequent activation of the function block via the function block coil EN.

With MST or CST mode, the Reset coil must be activated afterwards. The startup test is further described in section “Parameter SUT (Startup test)” on page 347.

Parameters	Function, parameterisation in the function block
OFF	No startup test required
SUT	The startup test must be carried out

The factory setting of this parameter is OFF.

h

If you are using the SG (safety gate) function block in the operating mode 1L or 2L (with guard locking monitoring) the startup test (SUT parameter) is not possible.



### Evaluation

The parameter checks the function block for the monitoring of the safety gate with one or two switches, as well as the operation with monitored guard locking.

Parameters	Function, parameterisation in the function block
1 CH	1-channel gate monitoring
2 CH	2-channel gate monitoring
1 L	1-channel gate monitoring with monitored guard locking
2 L	2-channel gate monitoring with monitored guard locking

easySafety is defined with a default setting for 2-channel evaluation.

### Discrepancy time

When activated, the discrepancy time SG..DT can be defined for 2-channel gate monitoring.

Parameters	Function, parameterisation in the function block
>DT	OFF; 0.5 - 3.0 s; adjustable in increments of 0.5 s

easySafety is factory set with a discrepancy time of 3.0 s.

**Outputs**

The actual value output QV: Indicates the current actual value of the discrepancy time.

Diagnostics output DG: Provides information the states of the function block. It is evaluated in the standard circuit diagram e. g. with the diagnostics function block.

Parameters	Function, parameterisation in the function block
QV:	Actual value discrepancy time: Time
DG:	Diagnostics: Double word

Table 20: Diagnostics-/Error codes

Status number		Plain text
Hexadecimal (0–F)	decimal (0-9)	
0000	0000	No Enable.
2001	8193	Enable issued; waiting for first (or only) input.
2002	8194	Waiting for second input.
2003	8195	Waiting for rising edge at Reset.
2004	8196	Waiting for falling edge at Reset.
2005	8197	Only one channel has been opened.
200E	8206	Waiting for inputs during startup testing.
2015	8213	Waiting for activation of guard locking.
8009	32777	Protective door closed (QS = 1).
F001	61441	Error: Discrepancy time expired.
F00B	61451	Error: Reset and inputs operated on function block startup.
F00E	61454	Error: Only one channel was opened and closed.

Further information on these outputs is provided in section "Common features", page 348.

### Coils and contacts

Function block coils initiate the functions of the function block and monitor the connected safety transmitters.

The contacts of a safety function block confirm the enable conditions present, selected operating modes or indicate errors.

#### Coils

Connect the function block coils SG..I1 and SG..I3 directly to the device terminals IS1 to IS14. The coils monitor the signal of the light curtain in the safety circuit diagram. Monitor the signal of the door switch and guard locking in the safety circuit diagram.

The reset coil SG..RE resets the function block in the Manual Start (MST) and Controlled Start (CST) mode and the starts of normal operation. Used in the safety circuit diagram.

The function block is enabled either in the safety or in the standard circuit diagram with its enable coil SG..EN.

Coil	Function
SG. . I 1	Gate switch 1
SG. . I 2	Gate switch 2
SG. . I 3	Monitoring of guard locking
SG. . RE	Reset
SG. . EN	Function block enable

#### Contacts

In the safety circuit diagram, the contact SG..QS enables the hazardous movement. It closes as soon as the contacts of the gate switches are closed (with AST operating mode). If monitoring of the guard locking is required, the contact SG..QS closes if the gate switches are closed and the guard locking is active.

If you wire the contact SG..ER in the standard and/or safety circuit diagram, it indicates the presence of an error by closing.

- Timeout of discrepancy time
- With 2-channel operation, only 1 channel opens and closes.

Contact	Function
SG..QS	Enable (contact closed -> safety gates and guard locking closed)
SG..ER	Error message (contact closed -> Error)

**Memory requirement**

The SG function block requires 28 bytes of memory.

**Operation of the function block**

If all conditions for the safe operation are fulfilled, the enable coil contact SG...QS is closed and enables operation.

If one of the coils SG..I1 and SG..I2 drops out, and also SG..I3 with the monitoring of guard locking, the enable is removed, the enable contact SG..QS opens the hazardous movement can be stopped.

**Error detection and acknowledgement**

The safety gate function block detects the timeout of the discrepancy time.

Error	Error acknowledgement
Timeout of discrepancy time DT	Dropping out of SG..I1 and SG..I2

General information on Errors and how easySafety reacts to them, is provided in the section "Diagnostics using the ER contact" on page 622.

**Example 1 - Architecture of Category 4 according to  
EN ISO 13849-1**

2-channel monitoring of a safety gate with cross-circuit monitoring of its external wiring. When the safety gate opens, the motor stops and the hazardous movement comes to a standstill. Pressing the Reset button after the safety gate closes initiates the re-enabling and the motor is started. The discrepancy time is set to 0.5 seconds.

The safety gate is monitored with two position switches B1 and B2. Both position switches are supplied with the test signals T3 and T4. They are connected to the device inputs IS13 and IS14. The safety device outputs QS1 and QS2 switch directly the contactors Q1 and Q2. The function block initiates the enable after the safety gate is closed and after the pressing and subsequent release of the Reset button that is connected to IS9.

This looks as follows in the electrical circuit diagram:

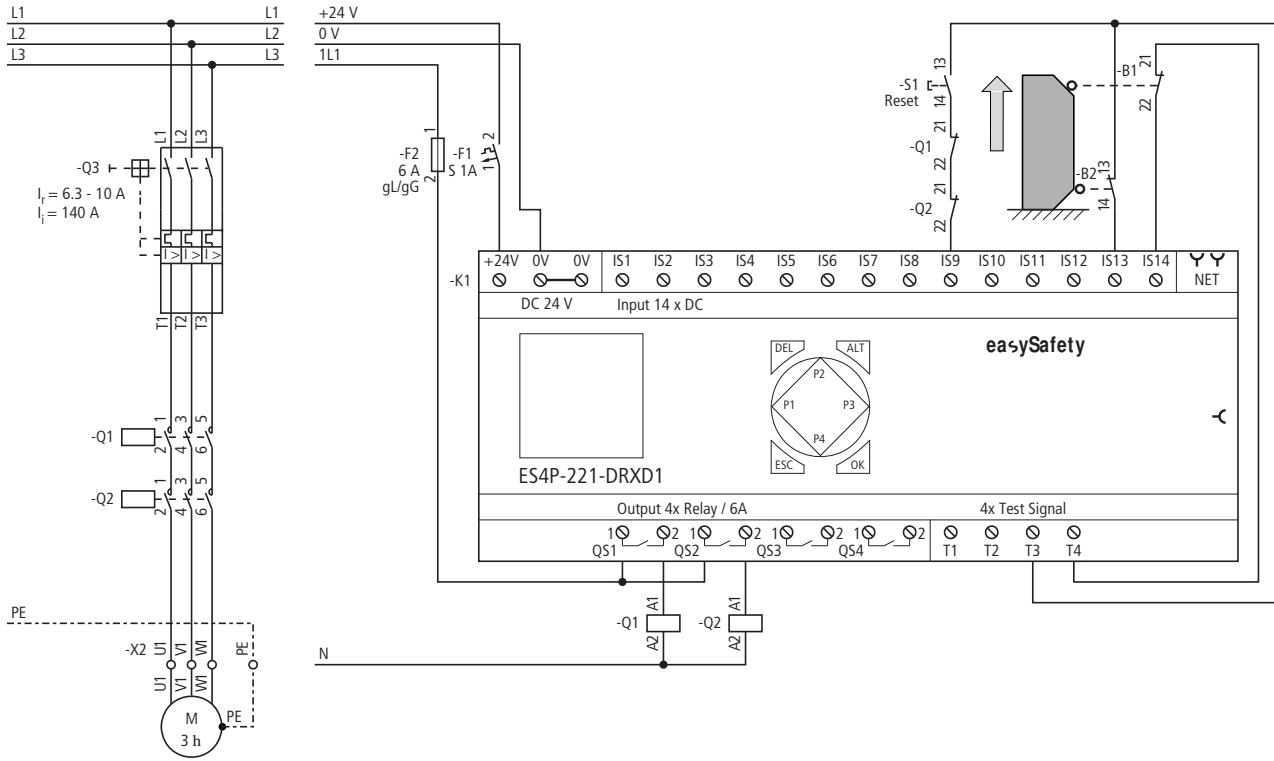

Figure 242: Example 1 "safety gate": electrical circuit diagram

The circuit diagram in easySafety now has five rungs:

I S13-----	SG01 I 1
I S14-----	SG01 I 2
I S09-----	SG01 RE
SG01 QS-----	QS01
	QS02

Figure 243: Example 1 "safety gate": Circuit diagram in easySafety

The input coils SG01I1 and SG01I2 of the function block are associated directly with the device terminals IS13 and IS14, the Reset coil SG01RE with IS9. The enable contact SG01QS switches the device outputs QS1 and QS2 directly.

```
SG01 NEN CST *
      OFF 2CH
      >DT 0.5s
```

The enable parameter stays at NEN, i.e. no external enable. The operating mode is changed to CST (Controlled Start). The evaluation of the gate monitoring switch stays at 2-channel (2CH) and the discrepancy time at 0.5 second.

```
I S01 <- -
...
I S09 <- T3 *
...
I S13 <- T3 *
I S14 <- T4
```

The test signals for cross-circuit monitoring are assigned to the corresponding device inputs in the TEST SIGNALS menu.

The signal diagram of the function block for this application shows:

- The dependencies of the enable contact of SG01QS on the status of coils SG01I1 and SG01I2
- The interrelationship between timed out discrepancy time SG01DT and the error output SG01ER
- The error acknowledgement with the coils SG01I1 and SG01I2
- the controlled re-enabling after the safety gate is closed and the Reset coil SG01RE has dropped out.

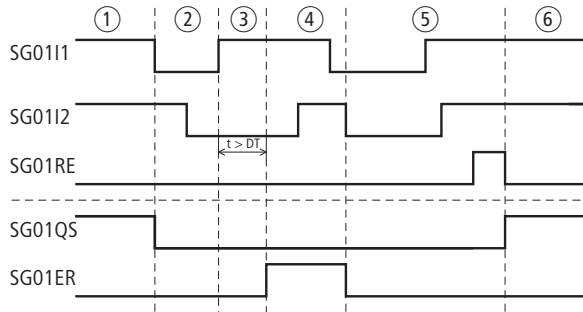

Figure 244: Example 1 safety gate signal diagram

- ① Closed safety gate.
- ② Opening of the safety gate.
- ③ Closing of the safety gate, timeout of the discrepancy time.
- ④ Error acknowledgement by opening the safety gate.
- ⑤ Closing of the safety gate and subsequent actuation of the Reset button.
- ⑥ Controlled enabling after dropping out of the Reset coil.



**Example 2 - Architecture of Category 4 according to  
EN ISO 13849-1**

2-channel monitoring of a safety gate with guard locking and cross-circuit monitoring of its external wiring. The actuation of the release button opens the guard, the safety gate is enabled and removes the enable from the hazardous movement. Pressing the Reset button after the safety gate closes initiates the re-enabling. The discrepancy time is set to 0.5 seconds.

The safety gate is monitored with a safety position switch B1 with a tumbler and another position switch B2. Both limit switches and the feedback of the tumbler are fed with test signals T1 to T3 and are connected to device inputs IS2, IS5 and IS6. Safety device outputs QS1 and QS2 switch contactors Q1 and Q2 directly. The function block issues the enable after the safety gate is closed and the reset pushbutton that is connected to IS9 is activated.

This looks as follows in the electrical circuit diagram:

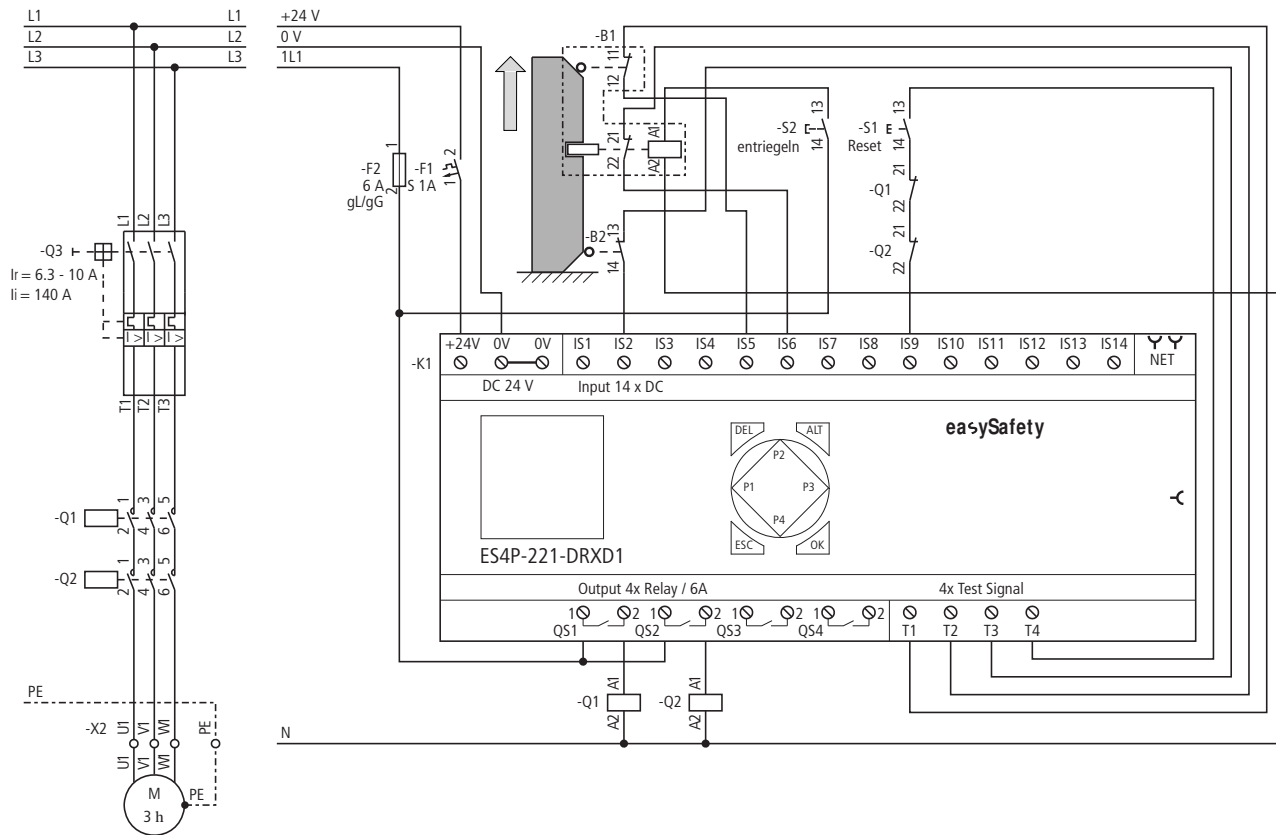

Figure 245: Example 2 "safety gate": electrical circuit diagram

The circuit diagram in easySafety now has six rungs:

I S02	-----	SG01 1
I S05	-----	SG02 2
I S06	-----	SG02 3
I S09	-----	SG01 RE
SG01 QS	-----	QS0 1
		QS0 2

Figure 246: Example 2 "safety gate": Circuit diagram in easySafety

The input coils SG0111 and SG0113 of the function block are associated directly with the device terminals IS2, IS5 and IS6, the Reset coil SG01RE with IS9. The enable contact SG01QS switches the device outputs QS1 and QS2 directly.

SG01	NEN	MST	*
	OFF	2L	
>DT	0.5s		

The enable parameter and operating mode stay in the default setting. The evaluation of the safety gate monitoring is set to 2L (2-channel with guard locking) and the discrepancy time to 0.5 seconds.

I S01	<-	-
I S02	<-	T3
I S03	<-	-
I S04	<-	-

The test signals for cross-circuit monitoring are assigned to the corresponding device inputs in the TEST SIGNALS menu.

I S05	<-	T1
I S06	<-	T2
...		
I S09	<-	T4
...		
I S14	<-	-

The signal diagram of the function block for this application shows:

- the dependencies of the enable contact of SG01QS on the status of coils SG0111, SG0112 and SG0113.
- the interrelationship between timed out discrepancy time SG01DT and the error output SG01ER.
- the error acknowledgement with the coils SG0111 and SG0112.
- the manual re-enabling after the safety gate is closed and the Reset coil SG01RE has dropped out.

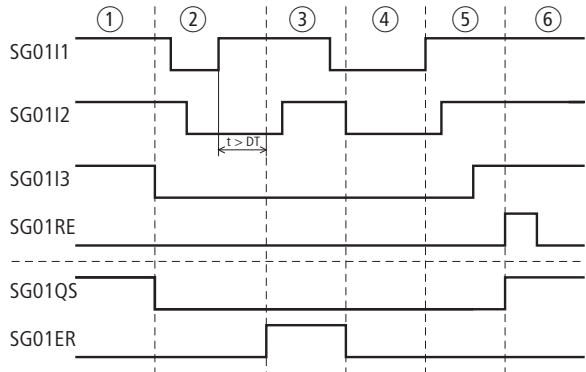

Figure 247: Example 2 safety gate signal diagram

- ① Closed safety gate, release of guard locking.
- ② Opening of the safety gate, timeout of the discrepancy time.
- ③ Error acknowledgement by opening the safety gate.
- ④ Closing of the safety gate.
- ⑤ Guard locking.
- ⑥ Manual re-enabling after the Reset coil has picked up.

**TH, two-hand button**

The two hand button function block is used for the safety-related monitoring of safety 1 or 2-channel two hand buttons. It enables the safe enabling of a hazardous movement while the operator actuates the two hand button.

**h**

The function block supports two hand buttons in accordance with EN 574, Type IIIC. The two hand buttons can be configured with 1 or 2 channels.

easySafety allows the monitoring of up to seven 1-channel or three 2-channel two hand buttons.

**Function block**

Figure 248: Function block "two hand button"

- ① TH..I1 and TH..I2 coils: 1-channel: Monitoring of both two hand buttons (make). 2-channel: Monitoring of the connected two hand button 1 (make/break combination). Use only in the safety circuit diagram.
- ② Coils TH..I3 and TH..I4: Only for 2-channels: Monitoring of connected two hand button 2 (make/break combination). Use only in the safety circuit diagram.
- ③ Coil TH..EN: Selective activation or deactivation of the function block. Use either in the safety or standard circuit diagram.

- ④ Contact TH..QS: Closes when conditions for normal operation present and enables the hazardous movement.  
Use only in the safety circuit diagram.
- ⑤ Contact TH..ER: Closes in the event of an error.  
Use in the safety and in standard circuit diagram.
- ⑥ Diagnostics output TH..DG: Provides information on the states of the function block.  
Evaluation only in the standard circuit diagram with the diagnostics function block DG.

**Wiring of the function block**

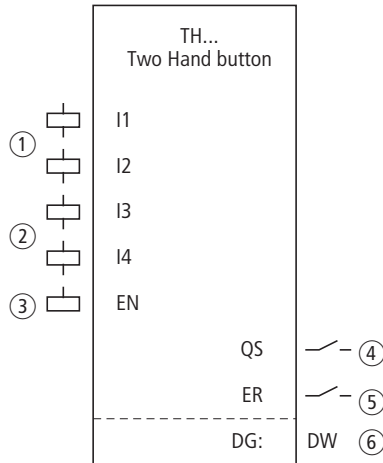
The relay uses different coils and contacts.

Wire its coils TH..I1 to TH..I4 directly to the device terminals IS1 to IS14. Example of a 2-channel function block:

I S01-----	TH011 1
I S02-----	TH011 2
I S06-----	TH011 3
I S08-----	TH011 4

Figure 249: Wiring of input coils

h

Make-break combinations are used as 2-channel two hand buttons. The following fixed assignment between the function block inputs and the two hand button must therefore be observed:

- Button 1a: make contact to TH..I1
- Button 1b: break contact to TH..I2
- Button 2a: make contact to TH..I3
- Button 2b: break contact to TH..I4

You can associate the function block contact TH..QS directly with one or several of the safety device outputs, for example:

TH01QS-----	QS0 1
	QS0 2

Figure 250: Wiring the enable contact to two device outputs

```

TH01 NEN * * * *
      * * * 2CH

```

### Parameters

When using the function block in the circuit diagram for the first time, use OK to automatically enter the general display of function block parameters, as shown in the figure on the left. Enter the function block settings here. The display contains the following elements:

TH01	Function block: two hand button, No. 01
NEN	Enable: none required
2CH	Evaluation: 2-channel two hand button

The parameters consist of the following:

#### Enable

The enable coil TH..EN allows the selective activation or deactivation of the function block. Further information can be found at section "Enable parameter, EN enable coil" on page 345.

Parameters	Function, parameterisation in the function block
EN	External enable required
NEN	(default settings)

#### Evaluation

This parameter defines how two hand buttons are to be monitored:

- 1-channel with two make contacts or
- 2-channel with two make/break contact combinations

Parameters	Function, parameterisation in the function block
1CH	1-channel evaluation
2CH	2-channel evaluation (default setting)

**Output**

Diagnostics output DG: Provides information the states of the function block. It is evaluated in the standard circuit diagram e. g. with the diagnostics function block.

Parameters	Function, parameterisation in the function block
DG:	Diagnostics: double worda table 21

Table 21: Diagnostics-/Error codes

Status number		Plain text
Hexadecimal (0–F)	decimal (0-9)	
0000	0000	No Enable.
2001	8193	Enable issued; waiting for first (or only) input.
2005	8197	Only one channel has been opened.
2016	8214	Two-hand pushbutton in normal position.
2017	8215	Two-hand pushbutton 1: undefined position.
2018	8216	Two-hand pushbutton 2: undefined position.
800B	32779	Two-hand pushbutton operated (QS = 1).
F006	61446	Error: Second pushbutton pressed too late (> 500 ms).
F00E	61454	Error: Only one channel was opened and closed.
F018	61464	Error: At least one input operated on function block startup.

Further information on this output is provided in section "Common features", page 348.



### Coils and contacts

Function block coils initiate the functions of the function block and monitor the connected safety transmitters.

The contacts of a safety function block confirm the enable conditions present, selected operating modes or indicate errors.

#### Coils

You connect the function block coils TH..I1 to TH..I4 directly to the device terminals IS1 to IS14. They monitor the signal of the two hand circuit in the safety circuit diagram.

The function of the function block is enabled either in the safety or in the standard circuit diagram with its enable coil TH..EN.

Coil	Function
TH. . I 1	Two-hand button channel 1
TH. . I 2	Two-hand button channel 2
TH. . I 3	Two-hand button channel 3
TH. . I 4	Two-hand button channel 4
TH. . EN	Function block enable

#### Contacts

In the safety circuit diagram, the contact TH..QS enables the hazardous movement. It closes if the two hand button is actuated correctly.

If you wire the contact TH..ER in the standard and/or safety circuit diagram, it indicates the presence of an error by closing.

Contact	Function
TH. . QS	Enable (contact closed -> two hand button actuated)
TH. . ER	Error message (contact closed -> Error)

**Memory requirement**

The function block TH requires 24 bytes of memory.

**Operation of the function block**

If you actuate the two hand button, the function block coils will switch as follows:

- 1-channel operation:
  - the coils TH..I1 and TH..I2 pick up.
  
- 2-channel operation:
  - the coils TH..I1 and TH..I3 pick up.
  - the coils TH..I2 and TH..I4 drop out.

If this occurs within a fixed time of 500 ms, the enable contact TH..QS closes and enables operation.

If one of coils picks up or drops out, the enable is removed, the enable contact TH..QS opens and the hazardous movement is stopped.

**Error detection and acknowledgement**

The function block detects the non-synchronous switching of the two hand buttons. Both switches must achieve the same switch state within a fixed time of 500 ms.

Error	Error acknowledgement
Timeout of the 500 ms	<ul style="list-style-type: none"> <li>• 1-channel operation:                             <ul style="list-style-type: none"> <li>– Dropping out of TH..I1 and TH..I2</li> </ul> </li> <li>• 2-channel operation:                             <ul style="list-style-type: none"> <li>– Dropping out of TH..I1 and TH..I3</li> <li>– Picking up of TH..I2 and TH..I4</li> </ul> </li> </ul>

General information on Errors and how easySafety reacts to them, is provided in the section “Diagnostics using the ER contact” on page 622.

**Example 1 - Architecture of Category 2 according to EN ISO 13849-1**

Monitoring of a 1-channel two hand button with cross-circuit monitoring between the connected make contacts. Actuation of the button triggers the enable.

The two hand button S1 is connected to the device terminals IS10 and IS11, the safety transistor output QS1 switches the contactor Q1 directly.

This looks as follows in the electrical circuit diagram:

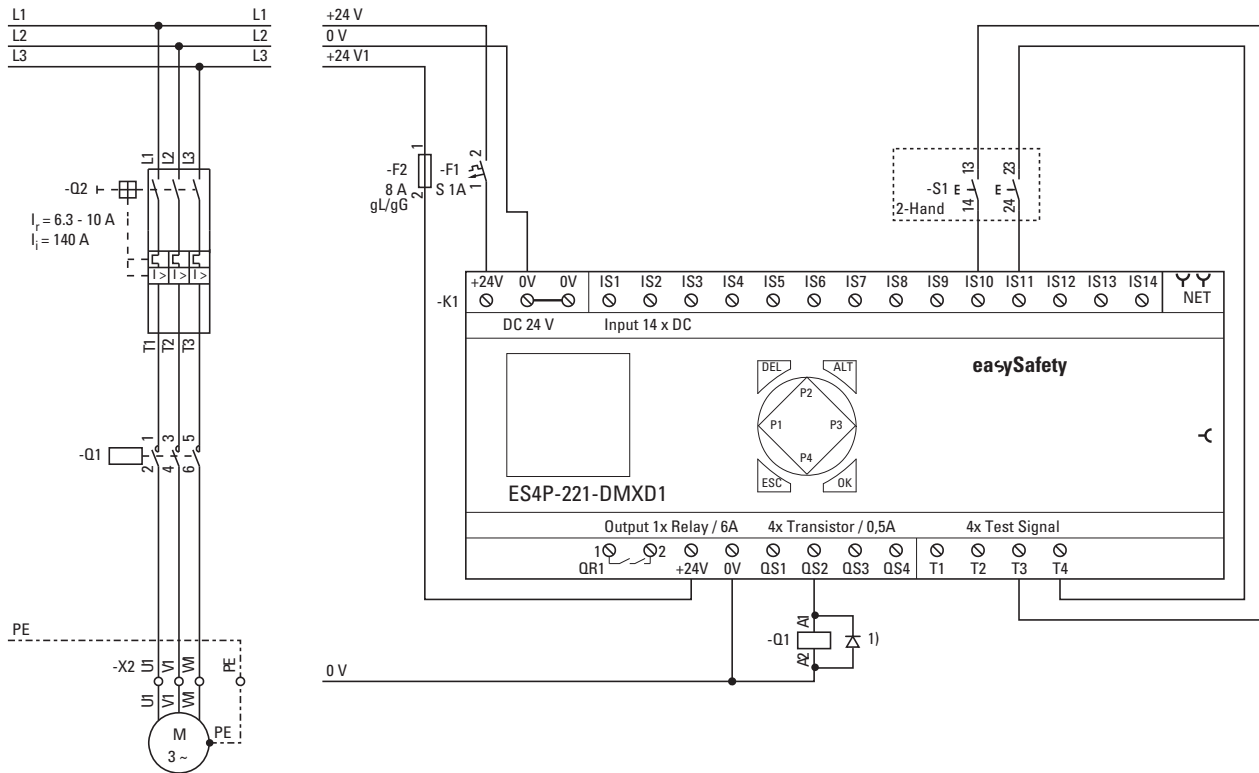

Figure 251: Example 1: Two hand button – electrical circuit diagram  
 1) Use free-wheel diode suppressors for ES4P-221-DMX.. devices with device version 02 and 10

The circuit diagram in easySafety has three rungs:

I S10-----	TH011 1
I S11-----	TH011 2
TH01QS-----	QS02

Figure 252: Example 1 two hand button: electrical circuit diagram in easySafety

The input coils TH011 and TH012 of the function block are associated directly with the device terminals IS10 and IS11, the enable contact TH01QS switches the device output QS2 directly.

```
TH01 NEN *** *
      *** 1CH
```

The enable parameter stays in the default setting, the evaluation of the two hand button is switched to 1-channel (1CH).

```
I S01 <- -
...
I S10 <- T3
I S11 <- T4
...
I S14 <- -
```

The test signals for cross-circuit monitoring are assigned to the corresponding device inputs in the TEST SIGNALS menu.

The signal diagram of the function block for this application shows the dependence of the enable contact TH01QS on the status of coils TH0111 and TH012:

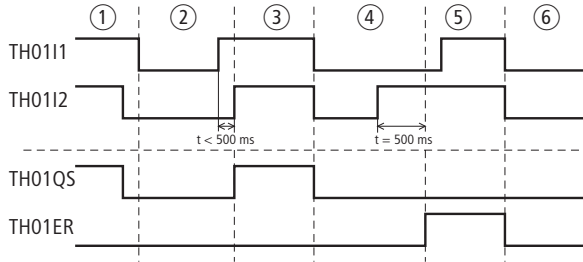

Figure 253: 1 two hand button example: Signal diagram

- ① Release of the two hand button, enable contact TH01QS opens.
- ② Renewed actuation with delayed pickup of TH0112  $< 500 \text{ ms}$ .
- ③ No error and enable contact TH01QS closes.
- ④ Release of the two hand button, TH01QS opens, renewed actuation and delayed pickup of TH0112  $> 500 \text{ ms}$ .
- ⑤ Error, TH01ER closes.
- ⑥ Error acknowledgement with the dropping out of TH0111 and TH0112.

**Example 2 - Architecture of Category 4 according to EN ISO 13849-1**

Monitoring of a 2-channel two hand button with cross-circuit detection. Actuation of the button triggers the enable.

The two hand button S2 is connected to the device terminals IS10 to IS13, the safety relay outputs QS1 and QS2 switch the contactors Q1 and Q2 directly.

This looks as follows in the electrical circuit diagram:

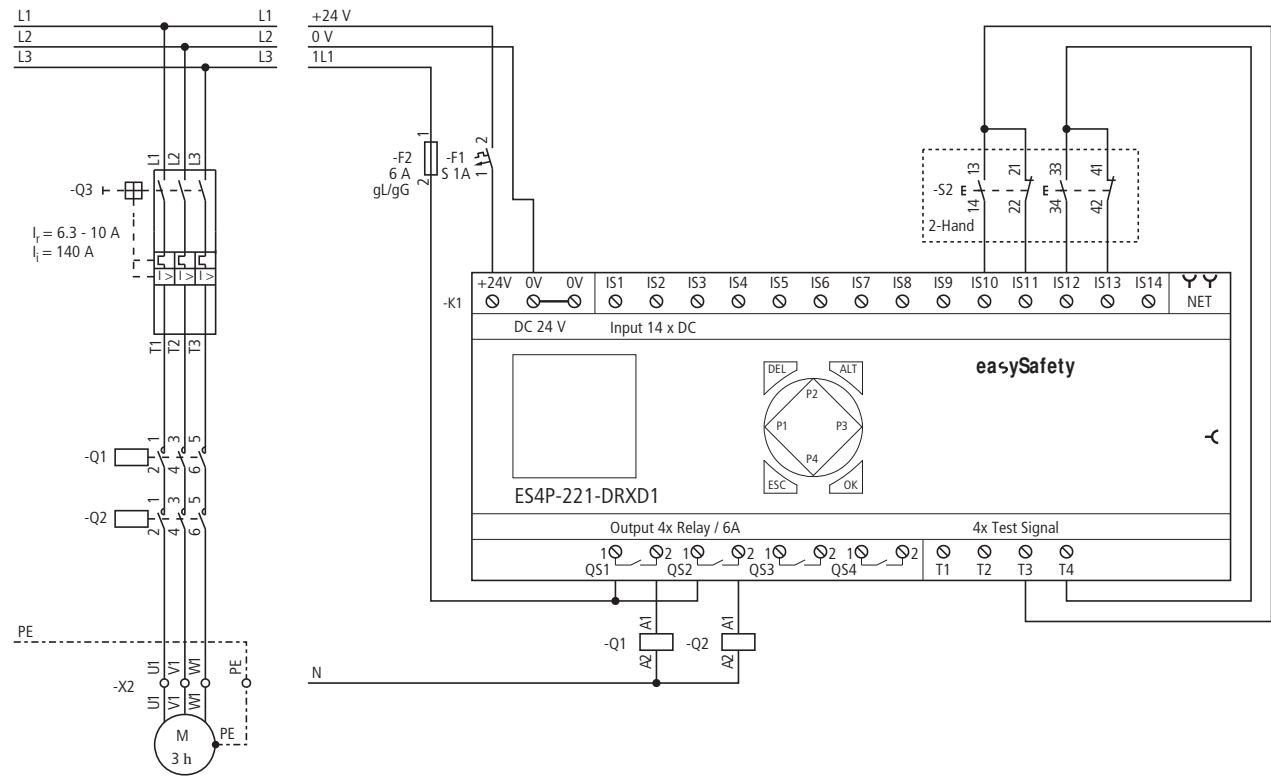

Figure 254: Example 2 two hand button: electrical circuit diagram

The circuit diagram in easySafety has six rungs:

I S10-----	TH011 1
I S11-----	TH011 2
I S12-----	TH011 3
I S13-----	TH011 4
TH01QS-----	QS01
	QS02

Figure 255: Example 2 two hand button: electrical circuit diagram in easySafety

The TH011 input coils of the function block are associated directly with the device terminals IS10 to IS13, the enable contact TH01QS switches the device outputs QS1 and QS2 directly.

TH01	NEN	***	*
	***	2CH	

The enable parameter and the parameter display stay in the default setting, the evaluation of the two hand button is switched to 2-channel (2CH).

I S01	<-	-
...		
I S10	<-	T3 *
I S11	<-	T3 *

The test signals for cross-circuit monitoring are assigned to the corresponding device inputs in the TEST SIGNALS menu.

The signal diagram of the function block for this application shows the dependence of the enable contact TH01QS on the status of coil TH0111 and TH0114:

I S12	<-	T4 *
I S13	<-	T4 *
...		
I S14	<-	-



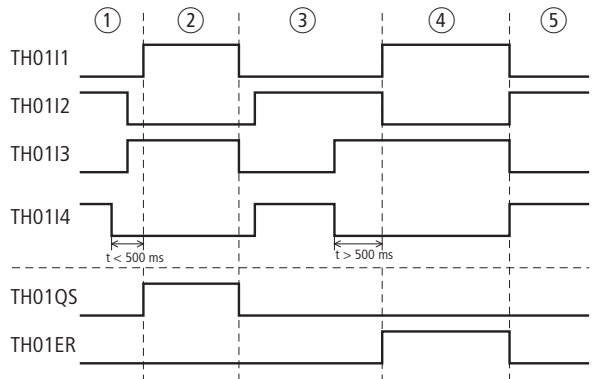

Figure 256: 2 two hand button example: Signal diagram

- ① Two-hand button not pressed, followed by operation of both N/O–N/C combinations within  $t < 500$  ms.
- ② No error: TH01QS closes.
- ③ Releasing of the two-hand button. TH01QS opens. Subsequent renewed actuation of both N/O–N/C combinations at an impermissible time interval ( $> 500$  ms).
- ④ Error: TH01ER closes.
- ⑤ Error acknowledgement: TH0111 and TH0113 drop out and pickup of TH0112 and TH0114.

**TS, Safety timing relay**

A safety timing relay allows you to change the switch time and the on/off time of an enable contact in the safety circuit diagram. The delay times can be configured between 50 ms and 99 h 59 min.

easySafety has 16 safety timing relays.

**h**

If you require a timing relay in the standard circuit diagram, use the 16 non-safety timing relays provided there with a similar function.

**Function block**

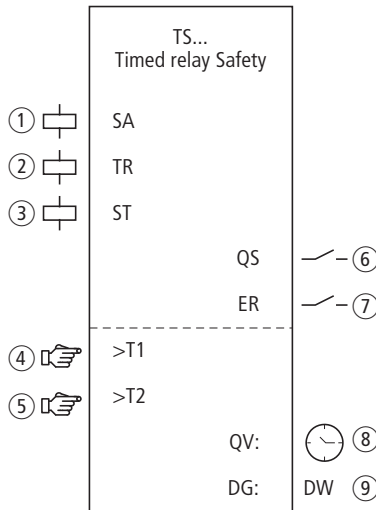

Figure 257: Timing relay function block

- ① Coil TS..SA: Safety activation of the function block.  
Use only in the safety circuit diagram.
- ② Coil TS..TR: Start of the timing relay.  
Use only in the safety circuit diagram.
- ③ Coil TS..ST: Stopping of the timing relay.  
Use only in the safety circuit diagram.
- ④ Parameter TS..I1: Time value 1.  
Can be used as an adjustable constant.
- ⑤ Parameter TS..I2: Time value 2.  
Can be used as an adjustable constant.

- ⑥ Contact TS..QS: Value changes according to the operating mode after expiry of reference times T1 and T2.  
Used only in safety circuit diagram.
- ⑦ Contact TS..ER: Closes in the event of an error.  
Use in the safety and in standard circuit diagram.
- ⑧ Actual value output TS..QV: Outputs the currently elapsed time.  
Indicated on the device or in easySoft-Safety.
- ⑨ Diagnostics output TS..DG: Provides information on the states of the function block.  
Evaluation only in the standard circuit diagram with the diagnostics function block DG.

### Wiring of the function block

The safety timing relay uses various different coils and contacts. Example of a timing relay function block:

I S01 -----	TS01 SA
ES01 QS-----	TS01 TR
MS01 -----	TS01 ST

Figure 258: Wiring of input coils

You can associate the function block contact TS.QS directly with one or several of the safety device outputs, for example:

TS01 QS-----	QS01
	QS02

Figure 259: Wiring the enable contact to two device outputs

TS01	S	X	*
	***	***	
>T1	000		
>T2	000		

**Parameters**

When using the function block in the circuit diagram for the first time, press OK to enter the general display of the function block parameters automatically, as shown in the figure on the left for an on-delayed timing relay. Enter the function block settings here. The display contains the following elements:

TS01	Function block: Safety timing relay No. 01
X	Operating mode: On-delayed
s	Time range: Seconds
>T1	Time value T1: 000s.000ms
>T2	Time value T2: 000s.000ms

The parameters consist of the following:

**Operating mode**

The Operating mode parameter defines the switch function of the timing relay.

Parameters	Switch function
x	On-delayed switching (one time value required)
	Off-delayed switching (one time value required)
x	On and off-delayed (two time values required)
#	Off delayed switching, setpoint retriggerable (one time value required)
	Single pulse switching (one time value required)
	Flash switching (two time values required)

### Time base

This parameter set is used to define the switch times.

Parameters	Time base and set time	Resolution
S 000.000	[Seconds], 0.00 to 999.95 s for constants and variable values	50 ms
M: S 00: 00	[Minutes: Seconds] 00:00 to 99:59 only for constants and variable values	1 s
H: M 00: 00	[Hours: Minutes] 00:00 to 99:59 only for constants and variable values	1 min.

## h

Minimum time resolution: 0.05 s (50 ms)

If a time value is less than the easySafety cycle time, the elapsed time will only be recognised in the next cycle.

The function block has a tolerance of **g** 50 ms.

### Time values

The parameters >T1 and >T2 are used to define one or two time values depending on the switch function of the relay.

Parameters	Function
>T1	Time value 1
>T2	Time value 2

**Outputs**

Actual value output QV: indicates the currently elapsed time.

Diagnostics output DG: Provides information the states of the function block. It is evaluated in the standard circuit diagram e. g. with the diagnostics function block.

Parameters	Function, parameterisation in the function block
QV:	Actual elapsed time value: Time
DG:	Diagnostics: double word a table 22

Table 22: Diagnostics-/Error codes

Status number		Plain text
Hexadecimal (0–F)	decimal (0-9)	
0000	0000	No Enable.
2001	8193	Enable issued; waiting for start via input TS..TR.
200B	8203	Waiting for decreasing trigger signal; output not active.
200C	8204	Allocated time running, output not active.
200D	8205	Allocated time stopped, output not active.
800C	32780	Timing relay output is active (QS = 1).
800D	32781	Waiting for decreasing trigger signal; output active (QS = 1).
800E	32782	Allocated time running, output is active (QS = 1).
800F	32783	Allocated time stopped, output is active (QS = 1).

Further information on these outputs is provided in section “Common features”, page 348.

### Coils and contacts

Function block coils initiate the functions of the function block and monitor the connected safety transmitters.

The contacts of a safety function block confirm the enable conditions present, selected operating modes or indicate errors.

#### Coils

The trigger coil TS..SA activates the timing relay in the safety circuit diagram.

The trigger coil TS..TR starts the run down of the timing relay. Used in the safety circuit diagram.

The Stop coil TS..ST interrupts the run down of the timing relay in the safety circuit diagram.

Parameters	Function
TS..SA	Safety activation of the timing relay
TS..TR	Start of the timing relay
TS..ST	Stop of the timing relay

#### Contacts

The TS..QS contact closes and/or opens in the safety circuit diagram, according to the operating mode, after the allocated time(s) has expired. For example, the TS..QS closes with the on-delayed safety timing relay after the allocated time has expired. It opens again if trigger coils TS..TR or TS..SA drop out.

If you wire the contact TS..ER in the standard and/or safety circuit diagram, it indicates the presence of an error by closing.

Contact	Function
TS..QS	Enable (contact closed -> time function active)
TS..ER	Error message (contact closed -> Error)

**Memory requirement**

The function block TS requires 40 bytes of memory.

**Operation of the function block**

The relay is activated through coil TS..SA and started through trigger coil TS..TR. The stop coil TS..ST interrupts the time lapse.

At function block inputs TS..T1 and TS ..T2 you enter the constants for the times. The time values are transferred depending on the time range selected.

- [S], Value in milliseconds, the penultimate position is rounded up to 0 or 5.
- [M:S], value in seconds.
- [H:M], value in minutes.

Different methods are used depending on the operating modes of the TS function block:

**Timing relay, on-delayed**

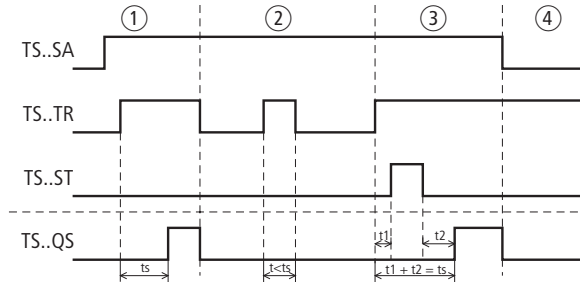

Figure 260: Operating diagram: time relay, on-delayed

- ① The set time  $t_s$  runs down without interruption.
- ② The set time does not run down because the trigger coil TS..TR drops out prematurely.
- ③ The Stop coil stops the run down of the time.
- ④ The dropping out of the coil TS..SA causes the timing relay to deactivate and the contact TS..QS opens.



### Timing relay, off-delayed

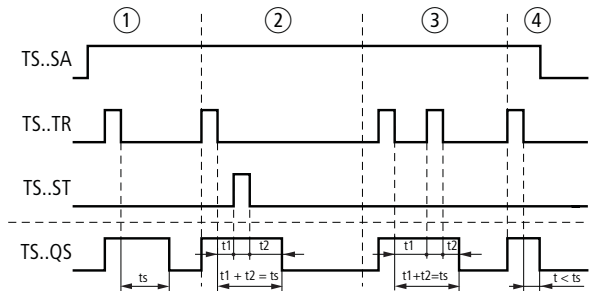

Figure 261: Operational diagram timing relay off-delayed

- ① The set time  $t_s$  elapses after the trigger coil is deactivated.
- ② The Stop coil stops the run down of the set time  $t_s$ .
- ③ The Trigger coil drops out twice. The set time  $t_s$  consists of  $t_1$  plus  $t_2$ .
- ④ The dropping out of the coil TS..SA causes the timing relay to deactivate and the contact TS..QS opens.

**Timing relay, off-delayed with retriggering**

If the time is running and the trigger coil is operated again, the actual value of the time already elapsed is set to zero. The complete setpoint value elapses again; with the subsequent drop-out of the trigger coil, the complete allocated time elapses again.

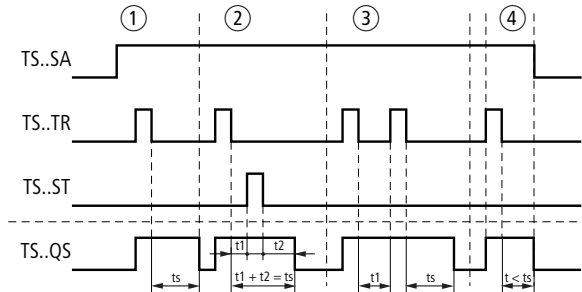

Figure 262: Signal diagram of timing relay, off-delayed (with/without retriggering)

- ① The set time  $t_s$  elapses after the trigger coil is deactivated.
- ② The Stop coil stops the run down of the set time  $t_s$ .
- ③ The Trigger coil drops out twice. The actual time  $t_1$  is cleared and the set time  $t_s$  elapses completely (retriggerable switch function).
- ④ The dropping out of the coil TS..SA causes the timing relay to deactivate and the contact TS..QS opens.

### Timing relay, on and off-delayed

Time value T1: on-delay time

Time value T2: off-delay time

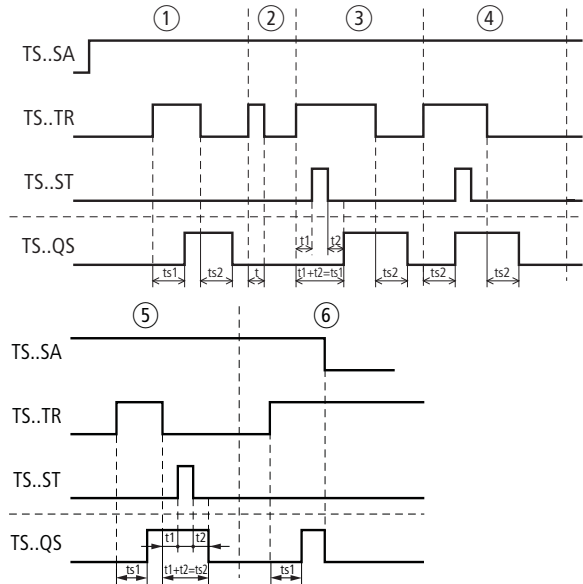

Figure 263: Signal diagram of "timing relay, on and off-delayed"

- ① The relay runs down both times ( $t_{s1}$  = on-delayed and  $t_{s2}$  = off-delayed) without any interruption.
- ② The Trigger coil drops out before the on-delay time  $t_{s1}$  is reached. The contact TS..QS stays open.
- ③ The Stop coil stops the run down of the on-delay time  $t_{s1}$ .
- ④ The Stop coil has no effect in this range.
- ⑤ The Stop coil stops the run down of the off-delayed time  $t_{s2}$ .
- ⑥ The dropping out of the coil TS..SA causes the timing relay to deactivate and the contact TS..QS opens.

### Timing relay, single pulse

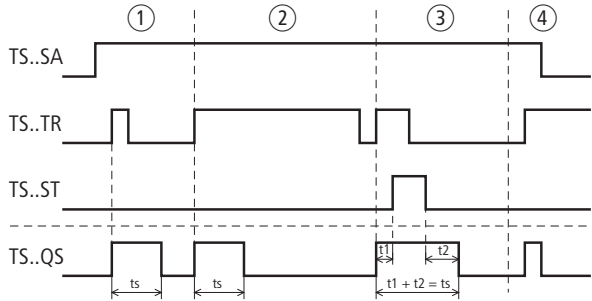

Figure 264: Signal diagram "timing relay, pulse shaping"

- ① The Trigger pulse is short, the contact TS..QS stays closed for the duration of the  $t_s$  pulse.
- ② The trigger pulse is longer than the set time for pulse duration  $t_s$ . The contact TS..QS stays closed only for the pulse duration  $t_s$ .
- ③ The Stop coil stops the run down of the time  $t_s$ .
- ④ The dropping out of the coil TS..SA causes the timing relay to deactivate and the contact TS..QS opens.

### Timing relay, synchronous and asynchronous flashing

Time value I1: mark time

Time value I2: space time

Synchronous (symmetrical) flashing: T1 equals T2

Asynchronous flashing: T1 not equal T2

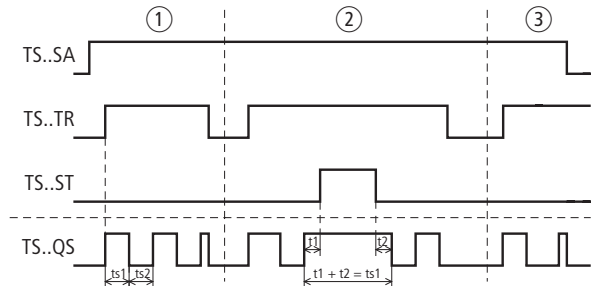

Figure 265: Signal diagram of timing relay, synchronous and asynchronous flashing

- ① The relay flashes via the TS..QS contact, for as long as the trigger coil TS..TR is activated.
- ② The Stop coil stops the run down of the flash time.
- ③ The dropping out of the coil TS..SA causes the timing relay to deactivate and the contact TS..QS opens.

### Example - Architecture of Category 4 according to EN ISO 13849-1

If the emergency-stop button is actuated, the motor should not stop immediately but only after 2 seconds (stop category 1 to EN IEC 60204-1).

This looks as follows in the electrical circuit diagram:

h

For information on the use of the emergency-stop safety function block, see the example concerning how to monitor a 2-channel emergency-stop button on page 368.

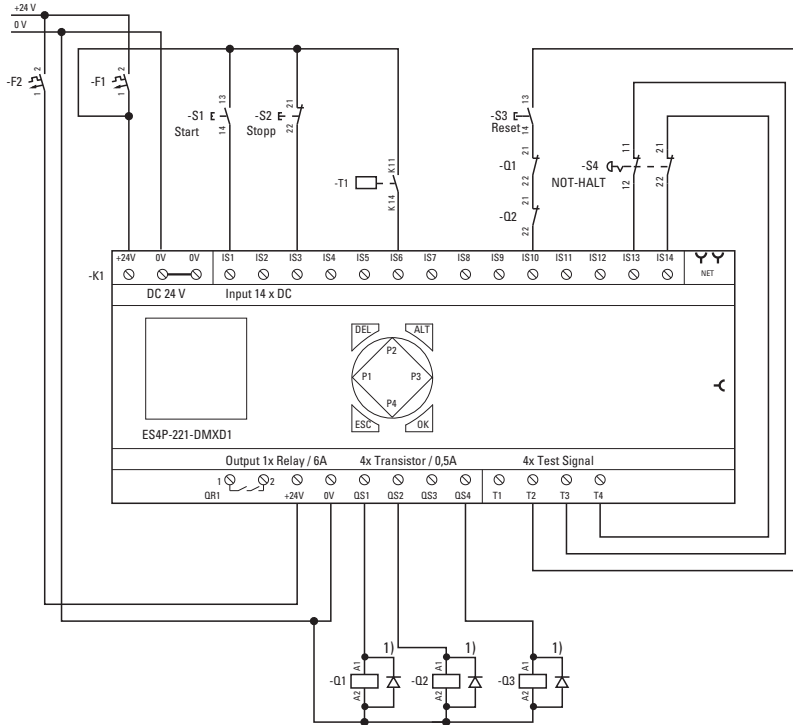
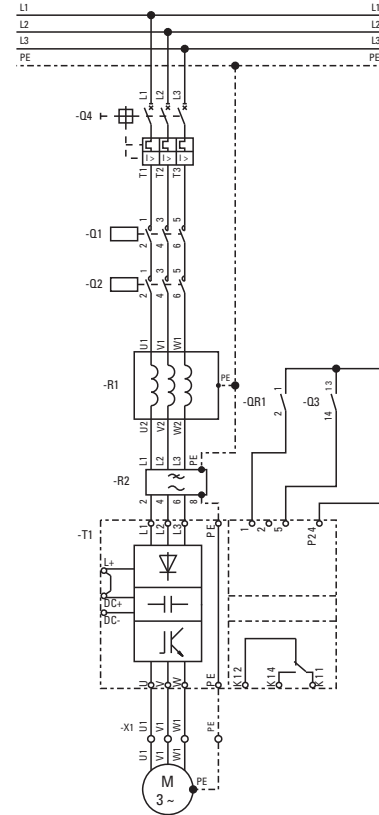

Figure 266: Example, Emergency switching off: electrical circuit diagram

1) Use free-wheel diode suppressors for ES4P-221-DMX.. devices with device version 02 and 10



The circuit diagram in easySafety now has seven rungs:

I S09-----	ES01 I 1
I S10-----	ES01 I 2
I S13-----	ES01 RE
-----	TS01 SA
ES01 QS-----	TS01 TR
TS01 QS-----	QS01
	QS03

Figure 267: Example, emergency-stop, stop category 1 according to IEC 60204-1: Circuit diagram in easySafety

The timing relay TS01 is always active as the coil TS01SA is always energized. The output of the emergency-stop function block ES01QS controls the trigger coil TS01TR of the timing relay. The output of the timing relay, i.e. the contact TS01QS, switches the device outputs QS1 and QS3.

The settings of the emergency-stop function block as well as the assignment of the test signals are shown in the figures on the left.

```
ES01 NEN CST *
      *** 2CH
>DT  0.5S
DG:
```

```
I S01 <- -
...
I S09 <- T3
I S10 <- T4 *
...
I S13 <- T4 *
I S14 <- -
```

```
TS01 S          *
      ***  ***
>T1  002.000
>T2  000
```

The timing relay is set to Off-delayed operating mode and the time value T1 to 2 seconds.

The signal diagram of the function block for this application shows:

- The start of the timing relay, triggered by the emergency-stop function block.
- The deactivation of the outputs after the delay time of 2 seconds has elapsed.

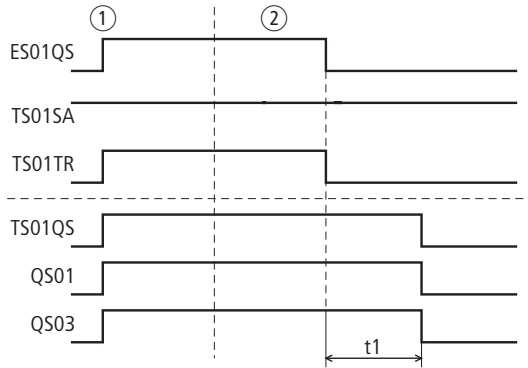

Figure 268: Example 2 emergency-stop: signal diagram

- ① Normal operation, emergency-stop not actuated, ES01QS closed.
- ② Emergency-stop is actuated, enable contact ES01QS opened. The assignment of the contact ES01QS to the trigger coil of the timing relay causes the off-delayed time to run down. After two seconds, the contact of timing relay TS01QS opens and switches off the two device inputs QS01 and QS03.



**ZM, zero (standstill) monitoring**

The zero monitoring function block is used where entry or access to the hazardous area is only permissible when the machine has come to a standstill. The function block does not enable access until the connected rotary encoder indicates the standstill of the machine.

The function block always operates with 2 rotary encoders.

A easySafety device can monitor the standstill of a shaft or a motor.

**Function block**

Figure 269: Zero speed monitoring function block

- ① Coil ZM..SA: Safety activation of the function block. (use mandatory).  
Use only in the safety circuit diagram.
- ② Coil ZM..RE: Reset of the function block in the Manual Start (MST) and Controlled Start (CST) mode and the starting of normal operation.  
Use only in the safety circuit diagram.
- ③ Coil ZM..EN: Selective activation or deactivation of the function block function (optional).  
Use either in the safety or standard circuit diagram.
- ④ Parameter ZM..FR: When the rotary frequency reaches or falls below this value, a standstill is signaled.  
Can be used as an adjustable constant.

- ⑤ Contact ZM..QS: When the parameterized rotary frequency reaches or falls below this value, this contact closes.  
Used only in the safety circuit diagram.
- ⑥ Contact ZM..ER: Closes in the event of an error.  
Use in the safety and in standard circuit diagram. In a fault scenario the contact TS..QS stays open.
- ⑦ Actual value output DG..QV: Indicates the current actual value of the rotation frequency.  
Indicated on the device or in easySoft-Safety.
- ⑧ Diagnostics output ZM..DG: Provides information on the states of the function block.  
Evaluation only in the standard circuit diagram with the diagnostics function block DG.

**Wiring of the function block**

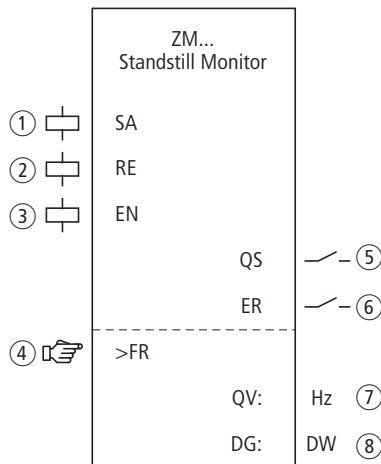
The relay uses different coils and contacts.

h

The rotation frequency input coils of the ZM function block are connected directly with the device inputs IS1 and IS2 so that the rotary encoders are always connected here and no function block wiring is required.

j

**Danger!**

Two static High signal levels at device inputs IS1 and IS2 are always regarded as standstill by the easySafety device; contact ZM01QS is not switched off.

This behaviour applies also to two static Low signal levels if these are applied to IS1/IS2 immediately after a change to operating mode RUN and until the first Low-High edge is detected.

h

easySafety enables the simultaneous operation of both function blocks for zero speed and overspeed speed monitoring using the same sensors.

Coils ZM..RE and ZM..SA allow an internal association inside the safety circuit diagram. Example of a function block for zero speed monitoring:

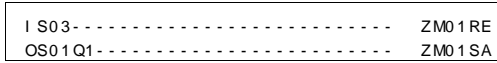

Figure 270: Wiring of input coils

You can associate the enabling contact ZM..QS directly for further processing, for example:

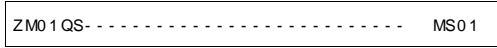

Figure 271: Wiring of the enable contact to a safety marker for further processing in the safety circuit diagram



**Warning!**

When using function block ZM, make sure that it enables the dangerous motion through its contact ZM..QS.

Keep in mind that the easySafety device can change into its safe state when the dangerous motion is already enabled before the easySafety device is switched on.

**Parameters**

When using the function block in the circuit diagram for the first time, use OK to automatically enter the general display of function block parameters, as shown in the figure on the left. Enter the function block settings here. The display contains the following elements:

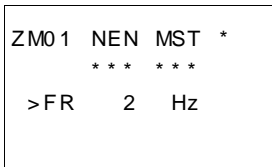

ZM01	Function block: Zero speed monitoring, No. 01
NEN	Enable: none required
MST	Operating mode: Manual start
>FR	Maximum rotation frequency: 2 Hz

The parameters consist of the following:

**Enable**

The enable coil ZM..EN allows the selective activation or deactivation of the function block. Further information can be found at section "Enable parameter, EN enable coil" on page 345.

Parameters	Function, parameterisation in the function block
EN	External enable required
NEN	No external enable required

The default setting for this parameter is NEN; the function block is active without an external enable.

**Operating mode**

After easySafety has determined the conditions for safe operation, there are different kinds of restarts possible. They are described in greater detail as operating modes in chapter "Operating mode parameter, RE reset coil" on page 346.

Parameters	Function, parameterisation in the function block
AST	Automatic start, no manual restart
MST	Manual start
CST	Controlled start

The factory setting of this parameter is MST, Manual Start.

### Standstill rotation frequency

The standstill rotation frequency FR is the maximum permissible rotation frequency at which the ZM function block detects the standstill. Enter the set value for this frequency as a parameter >FR. You determine the actual value via the two encoders on the motor.

Parameters	Function, parameterisation in the function block
>FR	2 - 50 Hz; adjustable in increments of 1 Hz

The default setting for this parameter is 2 Hz.



#### Warning!

The highest permissible rotational frequency at device inputs IS1 and IS2 is 1000 Hz. Frequencies above 1000 Hz are no longer reliably detected by the easySafety-device and can cause malfunction.

It is the engineer's responsibility to ensure that no higher rotary frequencies can be applied at IS1 and IS2.

**Outputs**

The actual value output QV: Indicates the actual value of the rotation frequency with a tolerance of less than 3 percent..

Diagnostics output DG: Provides information the states of the function block. It is evaluated in the standard circuit diagram e. g. with the diagnostics function block.

Parameters	Function, parameterisation in the function block
QV:	Rotation frequency actual value: 2 - 50 Hz
DG:	Diagnostics: double worda table 23

Table 23: Diagnostics-/Error codes

Status number		Plain text
Hexadecimal (0-F)	decimal (0-9)	
0000	0000	No Enable.
2001	8193	Enable issued, wait for safe activation via ZM..SA input.
2003	8195	Waiting for rising edge at Reset.
2004	8196	Waiting for falling edge at Reset.
2009	8201	Measurement started.
8010	32784	Standstill detected (QS = 1).
F007	61447	Error: Both channels on Low (open circuit).
F008	61448	Error: Frequency measuring range exceeded (>1200 Hz).
F009	61449	Error: Different input frequencies.
F00A	61450	Error: No pulses on one channel.
F013	61459	Error: Reset operated on function block startup.

Further information on these outputs is provided in section "Common features", page 348.

### Coils and contacts

Function block coils initiate the functions of the function block and monitor the connected safety transmitters.

The contacts of a safety function block confirm the enable conditions present, selected operating modes or indicate errors.

#### Coils

The ZM..SA function block coil is used to start the monitoring function of the function block.

You can link the coil, for example, with the Enable contact of another safety function block.

The reset coil ZM..RE resets the function block in the Manual Start (MST) and Controlled Start (CST) modes and starts normal operation. Used in the safety circuit diagram.

The function block is enabled either in the safety or in the standard circuit diagram with its enable coil ZM..EN.

Coil	Function
ZM . SA	Safety activation of the function block
ZM . RE	Reset
ZM . EN	Function block enable

#### Contacts

The contact ZM..QS indicates the standstill of the motor in the safety circuit diagram. This signal can be used for example for the release device of a guard.

If you wire the contact ZM..ER in the standard and/or safety circuit diagram, it indicates the presence of an error by closing.

Contact	Function
ZM . QS	Enable (contact closed -> zero speed reached)
ZM . ER	Error message (contact closed -> Error)

**Memory requirement**

The ZM function block requires 36 bytes of memory.

**Operation of the function block**

A gear or cam wheel and two PNP sensors are required to measure the rotation frequency.

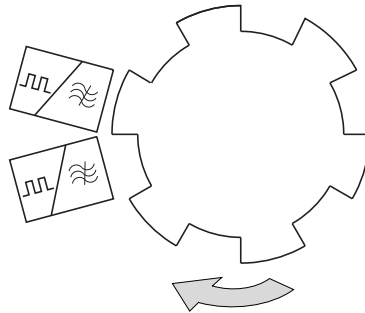

Figure 272: Zero speed monitoring: rotation frequency measuring

h

The proximity switches must be arranged so that at least one sensor is actuated at any time, in order for the function block to detect that the encoders are connected and that they are installed correctly.

- A wire break is indicated and the enable is removed if both sensors have not switched.
- If both function block coils receive a synchronous signal, a fault is indicated and the enable may possibly be removed.
- After each change of easySafety into operating state RUN the two sensors can issue the same level without a fault message being generated. In operating mode AST contact ZM..QS is closed at that time.  
Only when the first edge is detected at one of the two inputs IS1/IS2 does the function block signal a fault if both sensors output the same level. Contact ZM..QS then opens.

The speed is determined by the frequency measured. The frequency depends on the number of pulses per revolution.



With a gearwheel on the shaft with 6 cams and a maximum speed of 20 rpm, the maximum rotation frequency FR can be calculated with the following formula:

$$FR [Hz] = C * n [rpm] / 60$$

$$2Hz = 6 * 20 rpm / 60$$

If the set idleness rotation frequency (FR) is exceeded, the enable for the drive is withdrawn. The enable is issued again in the following cases:

- In the MST and CST operating modes:
  - After the operation and following drop-out of reset coil ZM..RE.
  - When the rotation frequency falls a minimum of 5% below the set idleness rotation frequency.
- In the AST operating mode - automatic restart without restart interlock - immediately when the rotation frequency falls 5% below the set idleness rotation frequency.

**j****Danger!**

In order to avoid unexpected restarts, use Manual Start (MST) or Controlled Start (CST) operating mode.

**Error detection and acknowledgement**

The function block detects the fact that the maximum permissible rotation frequency (1000 Hz) has been exceeded, or the failure of the sensors at device inputs IS1 and IS2.

Error	Error acknowledgement
Maximum permissible rotation frequency exceeded	Drop out of coil ZM..SA for activation of the safety function block
Failure of sensors	Drop out of coil ZM..SA for activation of the safety function block

General information on Errors and how easySafety reacts to them, is provided in the section "Diagnostics using the ER contact" on page 622.

**Example**

The standstill of a machine is to be detected and transferred to marker MS01 as a signal for further processing. A standstill is recognised at a rotation speed of less than 10 rpm. Two inductive proximity switches in conjunction with a cam disk with 12 cams on the shaft measure the speed.

The zero speed monitoring function is always active (ZM01SA = 1).

The rotation frequency to be set on the easySafety is:  
 $12 \times 10 \text{ rpm} / 60 = 2 \text{ Hz}$ .

This looks as follows in the electrical circuit diagram:

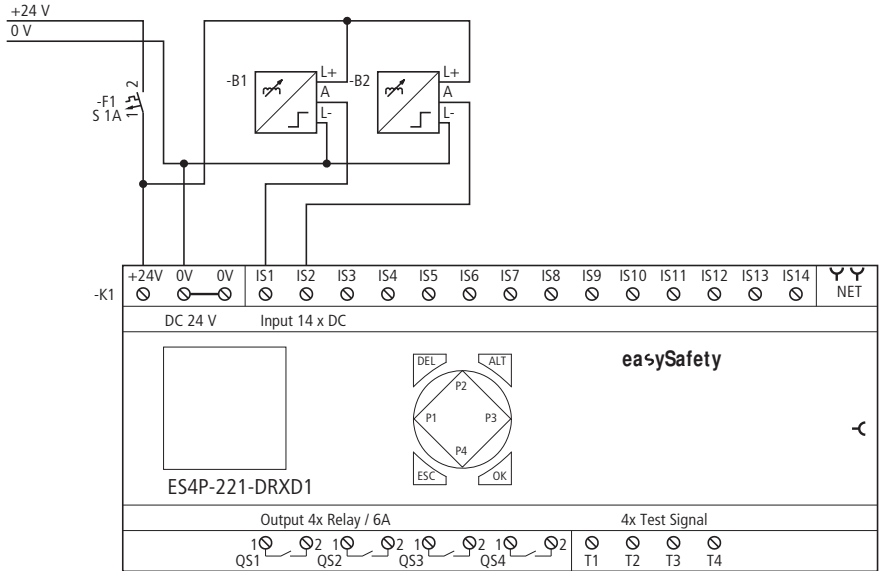

Figure 273: Zero speed monitoring example: Electrical circuit diagram

The circuit diagram in easySafety only has two rungs:

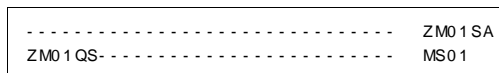

Figure 274: Zero speed monitoring example: Circuit diagram in easySafety

In this example, the activation coil ZM01SA is always active. ZM01QS switches the safety marker MS01 in the event of a standstill. If the speed of the motor is greater than 2 Hz, the contact ZM01QS opens and sets the safety marker MS01 to logic 0. The function block inputs ZM0111 and ZM0112 do not have to be wired as these are automatically connected with device inputs IS01 and IS02.

```

ZM01  NEN  AST  *
      ***  ***
      >FR   2   Hz

```

The enable parameter stays in the default setting, the operating mode is set to AST, Automatic Start without manual restart, the maximum zero speed rotation frequency is 2 Hz.

The signal diagram of the function block for this application shows the dependence of the enable contact ZM01QS on the measured frequency at the function block coils ZM01I1 and ZM01I2:

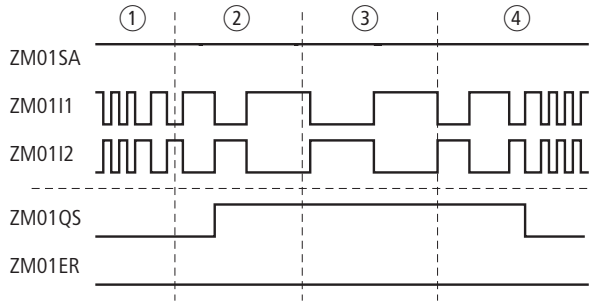

Figure 275: Zero speed monitoring example: signal diagram

- ① The speed is more than 10 rpm, ZM01QS signals: "no standstill".
- ②, ③ The speed is less than 10 rpm, ZM detects the standstill and closes contact ZM01QS.
- ④ The speed of the motor increases and exceeds 10 rpm + 5 % hysteresis (= 11 rpm). ZM01QS opens and thus no zero speed indicated.

## 7 easyNet network

### Introduction to the easyNet network

The easyNet network, termed the NET in the following document, is based on the CAN (Controller Area Network) serial bus system. CAN complies with the ISO 11898 standard.

The NET is designed for a maximum of 8 stations. It enables the exchange of process and system data as well as the transfer of the safety circuit diagram from and to the NET stations.

j

#### **Danger!**

easyNet is a network designed for non-safety applications. Data transferred via this network must **not** be used for safety-relevant applications.

NET stations on the non-safety network can include all easySafety devices (safety control relays). Mixed operation of other NET stations such as easy800/MFD-Titan and easySafety NET stations can be implemented in an overall NET topology.

h

Distribute tasks amongst several devices which can exchange data with each other via the NET: easySafety devices for safety-related switching and MFD-Titan devices for display and operating tasks.

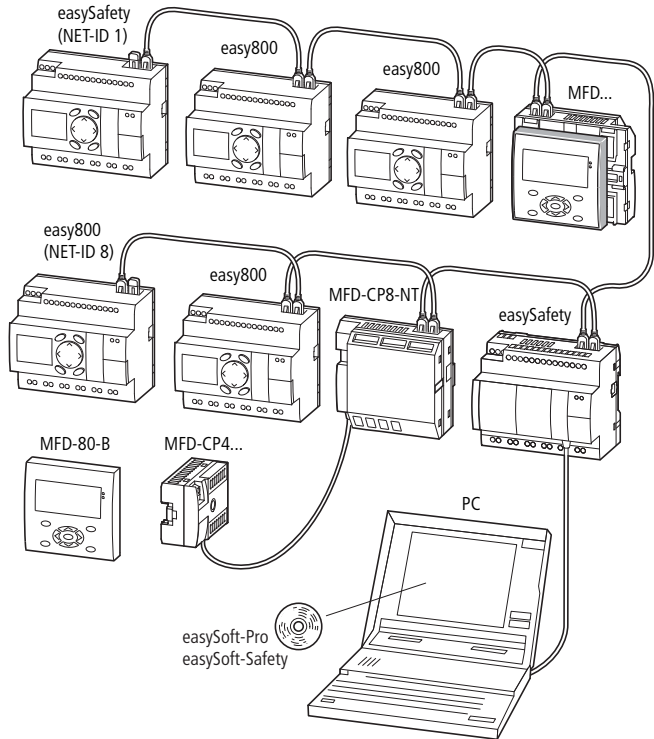

Figure 276: Mixed operation of NET stations

The safety control relay easySafety write and read accesses the data of other NET stations irrespective of whether these are safety devices. In this way, its send data can be further processed by the easy800 control relay and the MFD...-CP8-NT visualization device.

h

Remember that only data of the standard circuit diagram can be transferred via the non-safety easyNet network. You can therefore only control the data exchange with other NET stations in the standard circuit diagram.

The physically first NET station that is located at the beginning of the network manages the network and therefore the configuration, commissioning and diagnostics of the NET. This station with NET ID 1 is given the most extensive write/read access within the network.

In this way, the commissioning of NET stations is very simple. Apart from the installation with prefabricated cables, this only requires the following for the standard loop through topology:

- Definition of the first NET station by assigning NET ID 1 and the possible necessary modification of the baud rate in the NET PARAMETERS menu.
- Creation of the station list with automatic assignment of the NET IDs for the connected devices in the STATION menu.
- Configuration via the CONFIGURATION menu.

Further information on the configuration of the NET can be found on page 536.

Commissioning is even simpler with easySoft-Safety and easySoft-Pro. From easySoft-Pro version V6.30 Pro you can create NET configurations that contain easySafety devices from the ES4P device family in addition to previously established devices. This easySoft-Pro software covers all easySafety device versions under the heading ES4P device.

**h**

The complete configuration of the ES4P device can only be carried out with easySoft-Safety. However, easySoft-Pro allows you to transfer NET settings for commissioning such as "NET-ID", the baud rate and "Bus-Delay" to the easySafety device. This may be necessary in order to also address the other devices and test their functions.

Further information on this is provided in the Online Help of easySoft-Pro.

If you wish to configure a mixed operation of easySafety devices and previous NET stations, such as easy800, in certain circumstances the easySoft-Safety configuration software is sufficient. This is the case if the previous NET stations are only operated in REMOTE IO mode without a circuit diagram. Only if a circuit diagram is required for these conventional NET stations is the use of easySoft-Pro recommended. The parallel use of easySoft-Pro and easySoft-Safety is possible without any restrictions.

The NET network allows the following operations:

- Processing of additional inputs and outputs in the standard circuit diagram.
- Implementation of faster and more effective controls using distributed circuit diagrams.
- Date and time synchronisation of the NET stations.
- Read the inputs and outputs of all other NET stations in the standard circuit diagram.
- Read the inputs and outputs of previous NET stations that do not execute their own circuit diagrams, and write to their outputs, in the standard circuit diagram.
- Send 32-bit values to other stations using PUT function blocks in the standard circuit diagram and receive data from them using GET function blocks.
- Loading safety configurations from and to every station (a section "Transfer of the standard- and safety circuit diagram via the NET", page 529).
- Control the STOP/RUN operating mode of NET stations 2 to 8 based on the operating mode of station 1 (master). In order to do this, the REMOTE RUN option must be activated in NET stations 2 to 8.

**j****Danger!**

Ensure that the automatic starting of easySafety will not cause the unwanted starting of machines and plants.



### **Transfer behaviour of the NET stations**

Prior to every circuit diagram cycle the network data is written from the NET receive buffer to the operand image of the standard circuit diagram . The standard circuit diagram processes the next cycle with this data. At the end of the circuit diagram cycle the refreshed network data from the operand image is written to the NET send buffer and then transferred.

### **Reading and sending the data via the NET**

The communication process of a NET station reads every message on the NET and checks whether any messages are meant for its own address (NET ID). If yes, they are transferred to a receive memory.

If the content of the send memory changes, a message is sent provided that no other message is being transferred on the NET at this time. The NET ensures that each station can send its messages. This means that each station must maintain a delay time between the sending of messages.

The pause time increases the higher the number of stations and the lower baud rate setting.

The number of NET stations present is recognised by every station by means of a "sign of life" signal.

**h**

The following applies to a fast message transfer:

- Set the fastest possible baud rate to suit the network length and cable cross-section.
- Fewer messages means faster messages.
- Avoid transferring (download/upload) a circuit diagram while the NET stations are in RUN mode.

## Functions of the NET stations

There are various different NET station types that differ according to their type of programming and scope of functions, and some of which do not execute their own program.

### Net stations with or without program

- NET stations **with** their own program.
  - Possible NET IDs: 1-8
  - Possible devices: All
- NET stations **without** their own program, as input/output devices in REMOTE IO mode. In this type of application, NET station 1 must always have a program.
  - Possible NET IDs: 2-8
  - Possible devices: MFD-Titan and easy800

h

easySafety devices cannot be run in REMOTE IO mode as a NET station. These always require a safety circuit diagram.

### Types of programming

- NET stations of easy (programming in the form of a standard circuit diagram):
  - easy800 control relay
  - Operating and visualization devices (MFD-CP8-...-NT)
  - Safety control relay (ES4-...)
- NET stations for IEC programming (programming in accordance with IEC 61131-3 standard):
  - XC200 controllers
  - EC4-200 controllers (see AWB2724-1584GB)

### Function terminal mode

Terminal mode allows you to use the operating buttons of an MFD-CP8-...-NT, which is run as a NET station to create or modify the standard circuit diagram (the program) of another NET station.

h

Terminal mode access to easySafety devices via the NET is not permissible and therefore disabled.

On the other hand, this type of access is possible for a local connection of the MFD-CP8-... via the multi-function interface in terminal mode.

You can use the MFD-CP8-...-NT to establish in succession a connection to a NET stations.

Simultaneous operation of several logical terminal connections between two NET stations is possible apart from the easySafety devices.

h

Do not allow terminal mode access to a NET station from two sides at the same time as this will cause a fault on the NET. This also applies to simultaneous access to a device via the NET and via easySoft-Pro or an MFD-CP8-...-NT in terminal mode.

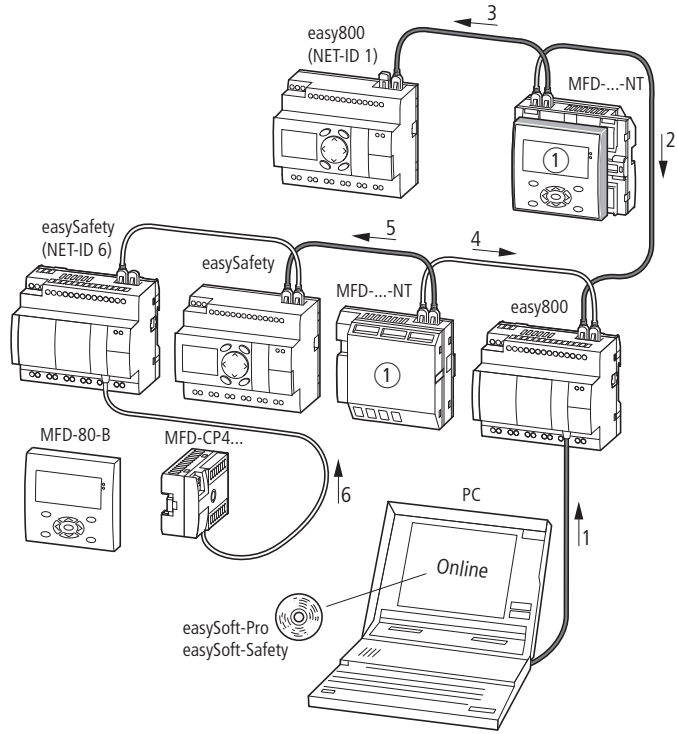

Figure 277: Access options in terminal mode

① Terminal mode

logical connection	Access permitted/not permitted	Explanation
1 + 2, 1 + 4	Not permissible	Simultaneous access to a NET station from 2 sides
2 + 3	not possible	In terminal mode, the display/operator system establishes only one logical connection at a time.
5	Not permissible	Terminal mode through the NET to easySafety
1 + 3, 3 + 4	Permissible	Simultaneous operation of several terminal connections to different stations
6	Permissible	Local terminal operation to a device that is also a NET station
1, 2, 3, 4	Permissible	Local terminal operation to one device in each case

## Transfer of the standart- and safety circuit diagram via the NET

From easySoft-Safety, the safety configuration can be transferred (PC => Device/Device => PC), compared (PC = Device ?) and deleted via the NET.

h

A safety configuration consists of the safety circuit diagram, a possible standard circuit diagram (incl. the function block diagram in each case) and the safety settings.

With this configuration you access via the NET the target device via the NET station that is connected to the PC with a programming cable. The NET provides this routing function automatically under the following conditions.

- The NET must be configured correctly and be in operation.
- The easySafety must have been assigned a safety ID (SID).

### Safety ID (SID1 - SID8)

You can also transfer the safety circuit diagram from easySoft-Safety to the target device via the NET.

To do this, you must assign a safety ID to the target device.

This safety ID identifies it uniquely and reliably as the receiver of the safety configuration. For the transfer, the values of the safety ID on the safety control relay and in the easySoft-Safety project must coincide.

The safety ID is permanently assigned to the safety control relay and is also retained if, for example, the device is given another position or NET ID in the NET.

The safety ID is a property of the device and does not have to be the same as the NET ID (although this recommended). It is not password protected and is not part of the configuration. You assign the safety ID in the following way:

- Via keypad and display directly on the device. In this case move to the system menu and select here the SAFETY ID menu.
- Via MFD-CP4.../CP8... in TERMINAL MODE if this is directly connected to the safety control relay.
- Via easySoft-Safety if the safety control relay to be parameterised is directly connected to the PC via a programming cable and the Local setting is selected in the Communication View.

---

### Commissioning NET stations

Requirements for commissioning the NET:

- All stations must be properly connected to the NET (a section "Connecting network easyNet", page 59), the bus terminating resistors on the physically first and last NET stations must be fitted and the power supply must be connected to all NET stations. The POW LED of all NET stations must be lit or flashing.
- As the first NET station, use a device with a display.
- The device to be parameterised must be in STOP mode. The POW LED of this NET station must be permanently lit.

When commissioning for the first time, the NET LED is "Off".

**h**

Your NET can only be configured by the station with NET-ID 1 if it has been set up according to the "loop-through" (a page 65) topology. In order to simplify the process, you should define all parameters through this NET station with NET-ID 1.

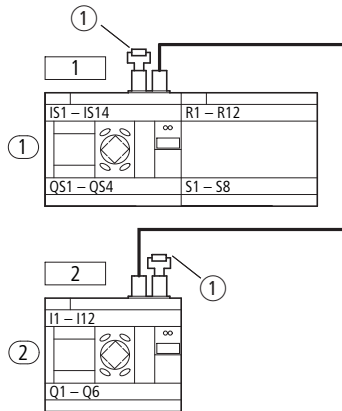
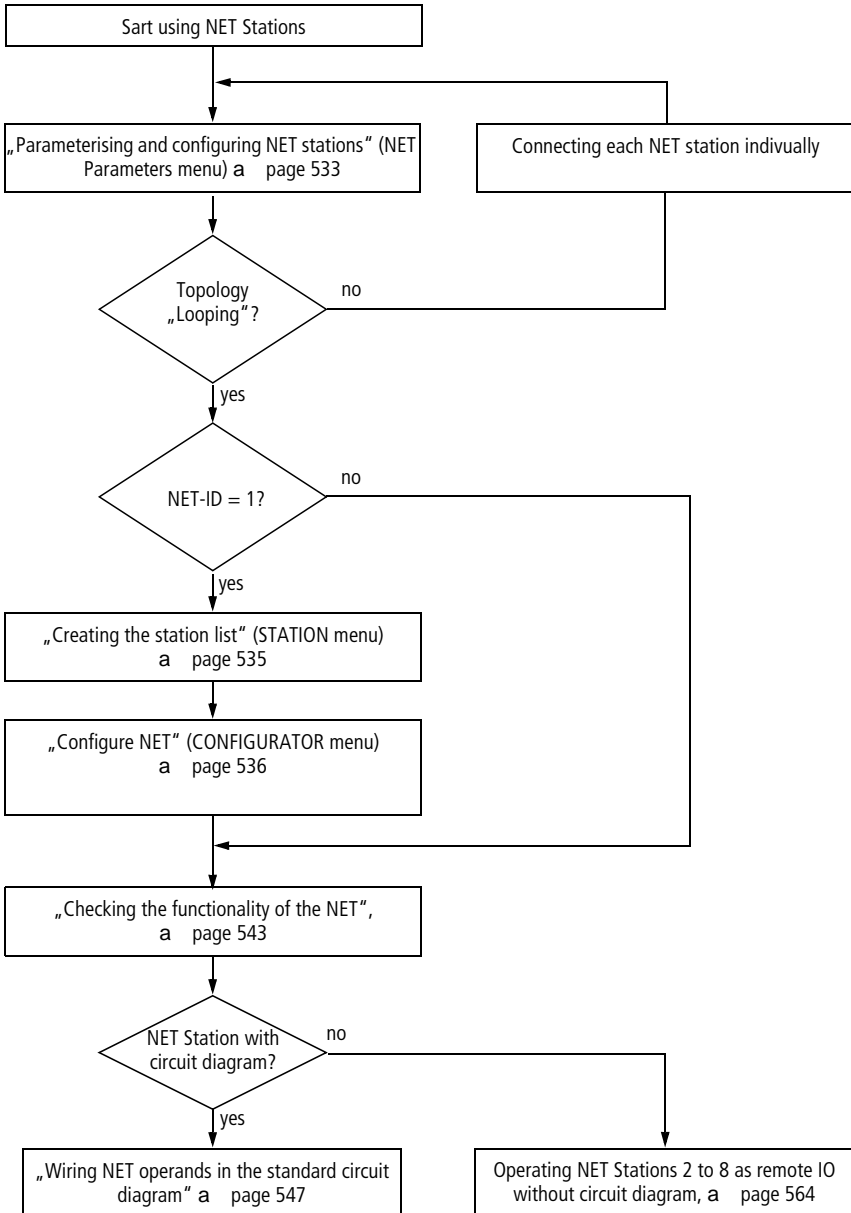

Figure 278: Example topology with two NET stations

① Bus termination resistor

□ physical location ○ station number

### "Commissioning NET stations" quick guide





## Parameterising and configuring NET stations

If you wish to work with the non-safety NET and exchange non-safety data with several stations, you must complete the parameterisation and configuration for this beforehand. This can be carried out conveniently with easySoft-Safety for easySafety devices or by using the operating buttons of a device with a display, as described below. For a detailed description of the description this NET-parameters, see page 559.

h

Start the parameterisation with the physically first device on the NET, the station with NET ID 1. This NET station can be used to configure the entire NET. You should only configure the device locally when you are replacing individual devices.

Carry out the parameter and configuration settings of a NET station in the NET PARAMETERS menu:

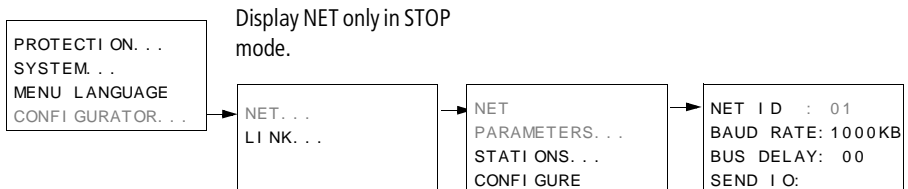

Figure 279: Menu NET PARAMETERS

You can access the NET PARAMETERS menu of the easySafety device in the following way:

X Simultaneously press the DEL and ALT buttons with the status display active.

```

S- PARAMETERS...
STD PARAMETERS
ACTI VATE PW
DELETE ALL
  
```

X Select the STD PARAMETERS menu option and press the OK button.

```

PROTECTI ON
SYSTEM
MENU LANGUAGE
CONFI GURATOR

```

X Select the CONFIGURATOR menu option and press the OK button.

h

The following steps, starting from the opening of the NET menu, are only possible in STOP mode.

```

NET . . .
LI NK . . .

```

X Select the NET menu option and press the OK button.

```

NET PARAMETER. . .
STATI ONS. . .
CONFI GURE. . .

```

X Select the NET PARAMETERS menu option and press the OK button.

```

NET I D : 01
BAUD RATE: 125 KB
BUSDELAY: 00
SEND I O
REMOTE RUN

```

X Use the and buttons to assign the NET ID (in this case: NET ID 01) in the NET PARAMETERS menu and confirm the setting with OK.

X Move to the baud rate and set here the maximum permissible transfer rate that your NET allows (a page 669). This will save you any unnecessary delay times:

The remaining parameters are not described further here. They are described in detail on page 559.

h

The functions REMOTE RUN and REMOTE IO are not required for the station with NET ID 1 and are therefore not available here. easySafety devices cannot be run in REMOTE IO mode.

X If all settings are ok, press ESC to exit the menu.

As you are currently parameterising the station with NET ID 1, you can now create the NET station list in the STATION menu, then assign the NET IDs via the CONFIGURATION menu and set a standard baud rate and bus delay time.

## Creating the station list

You create the station list in the STATION menu.

Only the physically first station with NET ID 1 manages a station list. You can only register other NET stations via this NET station or via easySoft-Pro and easySoft-Safety.

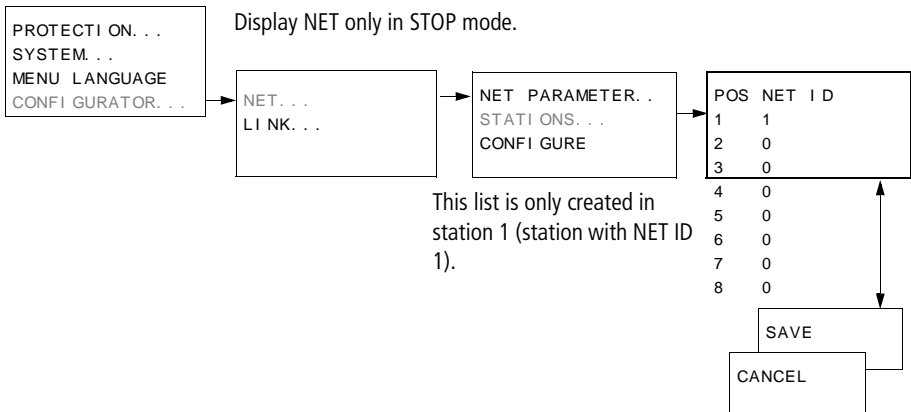

Figure 280: STATION menu

```

NET PARAMETERS...
STATI ONS...
CONFI GURE...
  
```

X Use the and cursor buttons to select the STATION... menu and press the OK button.

```

1 1
2 0
3 0
4 0
  
```

X Proceed to the station with physical address 2.

h

The left-hand column shows the geographical position of the device on the network. Use the number in the right-hand column to assign a NET ID to the device at this position. Position 1 is always assigned to NET ID 1.

You can only assign unused NET IDs.

1	1
2	2
3	0
4	0

x Select the required physical location, in this case position 2, with the and cursor buttons and press OK.

x Select the NET ID 2 with the and cursor buttons and confirm your input with the OK button.

At physical location 2, the station has been assigned station address 2.

x Press ESC to return to the STATIONS menu item.

### Configure NET

Once you have completed the parameter assignment of the NET stations and created a station list, you can then configure the easyNet. Carry out this configuration in the CONFIGURE menu.

You can only configure the NET network by entering settings on the NET station 1.

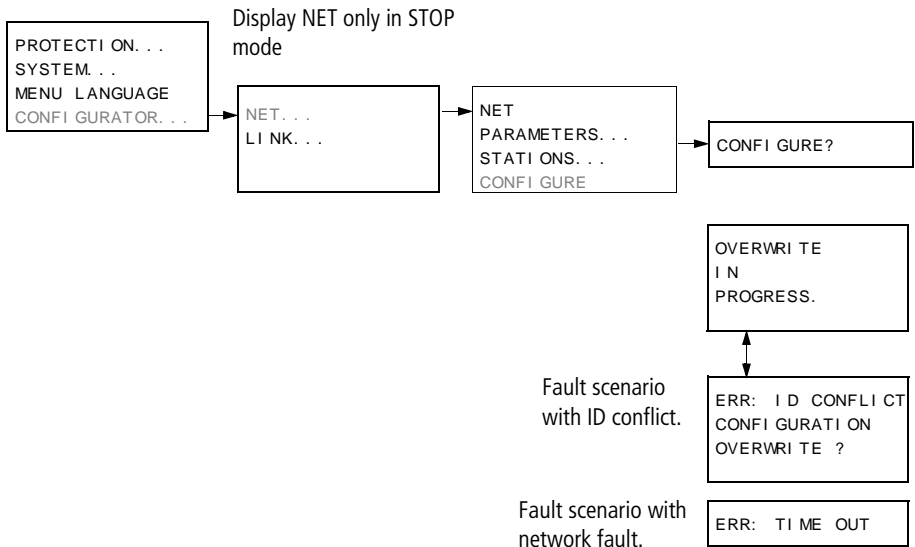

Figure 281: CONFIGURE menu

Requirement for the configuration using NET station 1:

- You must have wired your network as a “loop through” topology.
- All stations must be correctly connected to the NET and the termination resistors must have been connected.
- All stations have power, show the basic menu in the device display (the status display) and are in operating mode STOP. The POW and NET LEDs must be permanently lit.

For the configuration, all devices connected on the NET are assigned their NET ID in the order in which they were entered in the station list in the STATION menu. Furthermore, all devices are automatically set with the baud rate and bus delay time set on NET station 1.

# h

### Caution!

The SEND IO and REMOTE RUN parameters required for operation are not transferred to the connected device with the NET configuration.

If you require a parameter setting that is different to the factory setting, you can do this locally via the NET PARAMETERS menu of the NET station concerned. It is much simpler, however, to change the parameter settings via easySoft-Pro and easySoft-Safety in connection with a program transfer or a transfer of the safety configuration to the device concerned.

# h

During the NET configuration, all connected stations switch automatically to STOP. The NET LED for the stations with NET ID 2-8 switches to OFF.

```
NET_PARAMETERS . .
STATION . . .
CONFIGURE
```

### Procedure

X Proceed to the CONFIGURE menu item and press the OK button.

You will be asked to acknowledge whether you want to configure the system.

```
CONFIGURE?
```

X Press OK.

```
CONFIGURATION
IN
PROGRESS.
```

The configuration is successfully completed if the message on the left appears. The NET menu is displayed again and the NET LEDs of all stations flash. The NET is operational.

X Press the ESC key to exit the menu.

# h

Any errors during the configuration are indicated by messages or via the NET LEDs.

Further information can be found in section "Checking the functionality of the NET" on page 543.

## Messages

The following messages may be output during the configuration:

Table 24: Possible messages during the configuration

Message	Meaning
CONFIGURATION IN PROGRESS.	The configuration is error-free, the NET is then operational with the connected stations.
ERR: ID CONFLICT OVERWRITE CONFIGURATION ?	At least two NET stations have the same NET ID a section "Error message: ID conflict".
ERR: TIME OUT	Network fault, for example if the cable is not correctly fitted or interrupted. Or you are trying to assign NET ID 1 to a NET station, although a master with NET ID 1 is already present on the NET. Solution: Check the plug connection or the assigned NET IDs and restart the configuration.

### Error message: ID conflict

An error message will appear if a station has a NET ID that does not correspond to the physical location in the station list:

```
ERR: ID CONFLICT
CONFIGURATION
OVERWRITE ?
```

If you wish to correct the NET ID ( a section "Changing NET ID and position"), confirm the prompt with OK. Otherwise you can cancel the configuration with ESC.

### Changing the NET configuration

The configuration of the NET network can be modified at any time at NET station 1, physical location 1.

### Changing NET PARAMETERS

X The NET parameters are modified as described on page 533.

### Changing NET ID and position

- X Go to the physical location which is to be modified (a section "Creating the station list" on page 535).
- X Press the OK button.

h

Existing NET IDs can only be modified to free, non-assigned NET IDs. If all eight numbers are assigned, all NET IDs which are to be modified must be set to zero. After that all NET IDs can be reassigned.

For greater simplicity, the device sets all NET IDs to zero that have a physical location behind the first assigned zero.

- X Select the required NET ID with the and cursor buttons and confirm your input with the OK button.
- X Configure NET stations again using the CONFIGURATION menu, a page 538.



# h

**Caution!**

Operating the NET with two masters (two stations with NET-ID 1) is not allowed, and leads to malfunctions on the NET.

Possible effects of this type of incorrect configuration with two masters competing against each other, and in which one is operated in the STOP operating mode and the other in the RUN operating mode, are as follows:

NET stations with NET-ID 2 - 8 that should follow the operating mode changes of the NET station with NET-ID 1 automatically during operation (REMOTE RUN parameter definition) keep toggling constantly between the STOP and RUN operating modes.

When integrating a master that is already configured into an existing NET, please make sure that there is no other station with NET-ID 1 on the NET.

Also, when performing the configuration from easySoft-Pro or easySoft-Safety and a local connection to a station, please make sure you do not assign NET-ID 1 to this station if there is a master on the NET already.

Tip: Carry out a NET configuration through NET station 1 after every change to the NET.

**Deleting the safety configuration of a NET station**

Selecting DELETE ALL on a configured NET station will also delete its NET ID.

The device concerned is no longer a NET station, indicated by its switched off LED. The NET LED of all other configured NET stations in operation indicates the NET fault with a permanent light.

h

**Caution!**

If you delete the standard and safety configuration in NET station 1, the NET configuration managed by this station will also be deleted.

**Solution for the accidental deletion of the NET configuration**

- With "loop-through" topology

You must create a new NET configuration via the NET station 1 (a page 533).

- With "T-piece and spur line" topology.

Locally reassign a NET ID to the device concerned.

### Checking the functionality of the NET

You can make a visual check the functionality of the NET by means of the NET LED and in the circuit diagram via diagnostics bit ID01-ID08.

Table 25: Checking the functionality of the NET using the NET LED

Status of the NET LED	Meaning
Off	NET not operational, fault in configuration
Continuous light	NET station fault, possible causes: <ul style="list-style-type: none"> <li>• Net is initialized and at least one station has not been detected. Check the plug-in connections.</li> <li>• You have modified the NET ID or baud rate for at least one station after the configuration has been completed. Change the configuration.</li> <li>• On a NET station you have changed the configuration and thus deleted its NET configuration, a page 542. Reconfigure the NET via station 1.</li> <li>• You have expanded an existing NET station and replaced it with a new device which cannot be assigned parameters.</li> </ul>
Flashing	NET operating fault-free

### Diagnostics

Diagnostic bits ID01 - ID08 provide information on the presence or absence of NET stations. The state of the diagnostic bits is defined by the reception of a sign of life signal that every NET station sends.

The sign of life signal is sent cyclically depending on the baud rate.

The presence of the configured NET stations is evaluated at the following time intervalls:

Baud rate [kB]	Station must send a “sign of life” every ... [ms]	Station detects a missing sign of life signal from ... [ms]
1000	60	180
500	60	180
250	120	360
125	240	720
50	600	1800
20	1500	4500
10	3000	9000

If the sign of life signal of a configured NET station is no longer received, the diagnostics bit ID01 -ID08 for the missing NET station is immediately set to 1 for all remaining stations.

Diagnostics contact	Failure
ID 01	Fault in easyNet station 1
ID 02	Fault in easyNet station 2
...	...
ID 07	Fault in easyNet station 7
ID 08	Fault in easyNet station 8

If, for example, the station with NET ID 7 is missing, the diagnostics bit ID7 changes to 1 on every remaining NET station. The missing station is also indicated by means of a permanent light on the LED NET for all remaining NET stations.

# h

### Caution!

To ensure that a standard circuit diagram with NET operands (e.g. 3GT01) is always functioning with the latest data, you must scan the diagnostics bit ID.. of the sending NET station (see example below).

If you do not evaluate the appropriate diagnostics bit, this may cause malfunctions in your application.

Example of scanning the diagnostics bit ID..

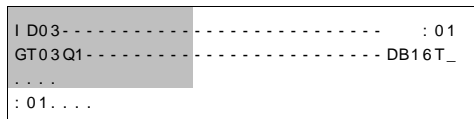

Figure 282: Scanning the diagnostics bit in standard circuit diagram

■ = Visible area

Table 26: Reaction to a missing sign of life signal on a NET station with or without safety configuration.

Station with circuit diagram	NET station 1 detects the failure of a NET station 2 to 8 without a circuit diagram: Input values received via nI., nR., nQ., nS., nRN.. and GT.. are set to 0. The output values for this NET station are not changed.
Station without circuit diagram NET station with a NET ID 2...8 in REMOTE IO mode	The output values Q01 - Q08 and S01 - S08 received from NET station 1 are set to 0.

h

After the power supply is switched on, the other NET stations and NET stations of type easySafety start up NET communication at different speeds. When these different types are used on a NET in mixed operation and are started simultaneously, a faster starting NET station will set its diagnostics contact ID.. = 1 to indicate a NET station of type easySafety as missing.

Solution: On all other NET stations delay the evaluation of the diagnostics bit ID.. for the NET stations of type easySafety by approx. 5 s by using the T function block (timing relay).

### Displaying the status display of other stations

On each device with a configuration and a display with operating buttons, you display the status of the inputs and outputs of every other NET station.

X For this change to the status display and press the ESC button.

```

1 I 12 . . . . .
      NT1
MO 06: 42
1 Q1 . . . . .   RUN

```

The cursor switches to the display of NET station NT1 and flashes. The NET ID precedes the display of the input/output ID (e.g. 1I..).

```

3 I 12 . . . . . 7 . . .
      NT3
MO 06: 42
3 Q1 . 3 . . 6 . .   RUN

```

X Change the number of the required NET station with the and cursor buttons.

The input/output states of this NET station are shown in the display (e.g. 3I../3Q..).

```

3 R12 . . . . . 7 . . .
      NT3
MO 06: 45
3 S1 . 3 . . 6 . .   RUN

```

X Press the ALT button several times if you wish to see the locally set time, the date or the group fault alarms for transistor outputs on this NET station.

Pressing the ESC button further will terminate the display of the input and output states of this NET station and will activate the local display of NET station NT1.

h

The NET station that shows the status on its display, cannot read out its own data from the NET (see the following example).

Example:

You are viewing the display of NET station NT3, and NT3 is flashing in the display. The inputs and outputs 3I.., 3R.., 3Q.. and 3S.. cannot be displayed.

After you have switched to the local display by pressing ESC, the NT3 display is no longer flashing and the states of the local inputs and outputs are displayed.

### Wiring NET operands in the standard circuit diagram

h

You use the NET operands only in the standard circuit diagram.

The NET operands that can be used depend on the operation of the devices on the NET and the following types of application:

Operating devices on the NET	Usable NET operands of data type...	
	Bit	32 Bit
REMOTE IO mode; only NET station 1 processes a circuit diagram.	nI.., nR.., nQ.., nS...	–
All NET stations each process a circuit diagram.	nI.., nR.., nQ.., nS.., nRN.., nSN...	nPT.. and nGT...
Mixed operation of NET stations with and without a circuit diagram.	nI.., nR.., nQ.., nS.., nRN.., nSN...	nPT.. and nGT...

Table 27: Position and addressing of the operands via easyNet

Station	Basic device via NET		Local expansion via NET		Bit data via NET		Word data via NET	
	Input nI	Output nQ	Input nR	Output nS	Input nRN	Output nSN	Receive	Send
1	2 I 1...2 I 16	2 Q 1...2 Q 8	2 R 1...2 R 16	2 S 1...2 S 8	2 RN 1...2 RN 32	2 SN 1...2 SN 32	GT 1	PT 1
	...	...	...	...	...	...	...	...
	8 I 1...8 I 16	8 Q 1...8 Q 8	8 R 1...8 R 16	8 S 1...8 S 8	8 RN 1...8 RN 32	8 SN 1...8 SN 32	16	16
2	1 I 1...1 I 16	1 Q 1...1 Q 8	1 R 1...1 R 16	1 S 1...1 S 8	1 RN 1...1 RN 32	1 SN 1...1 SN 32	GT 1	PT 1
	3 I 1...3 I 16	3 Q 1...3 Q 8	3 R 1...3 R 16	3 S 1...3 S 8	3 RN 1...3 RN 32	3 SN 1...3 SN 32	...	...
	...	...	...	...	...	...	16	16
3	8 I 1...8 I 16	8 Q 1...8 Q 8	8 R 1...8 R 16	8 S 1...8 S 8	8 RN 1...8 RN 32	8 SN 1...8 SN 32		
	1 I 1...1 I 16	1 Q 1...1 Q 8	1 R 1...1 R 16	1 S 1...1 S 8	1 RN 1...1 RN 32	1 SN 1...1 SN 32	GT 1	PT 1
	2 I 1...2 I 16	2 Q 1...2 Q 8	2 R 1...2 R 16	2 S 1...2 S 8	2 RN 1...2 RN 32	2 SN 1...2 SN 32	...	...
4	4 I 1...4 I 16	4 Q 1...4 Q 8	4 R 1...4 R 16	4 S 1...4 S 8	4 RN 1...4 RN 32	4 SN 1...4 SN 32	16	16
	...	...	...	...	...	...		
	8 I 1...8 I 16	8 Q 1...8 Q 8	8 R 1...8 R 16	8 S 1...8 S 8	8 RN 1...8 RN 32	8 SN 1...8 SN 32		
4	1 I 1...1 I 16	1 Q 1...1 Q 8	1 R 1...1 R 16	1 S 1...1 S 8	1 RN 1...1 RN 32	1 SN 1...1 SN 32	GT 1	PT 1
	2 I 1...2 I 16	2 Q 1...2 Q 8	2 R 1...2 R 16	2 S 1...2 S 8	2 RN 1...2 RN 32	2 SN 1...2 SN 32	...	...
	3 I 1...3 I 16	3 Q 1...3 Q 8	3 R 1...3 R 16	3 S 1...3 S 8	3 RN 1...3 RN 32	3 SN 1...3 SN 32	16	16
	5 I 1...5 I 16	5 Q 1...5 Q 8	5 R 1...5 R 16	5 S 1...5 S 8	5 RN 1...5 RN 32	5 SN 1...5 SN 32		
	...	...	...	...	...	...		
	8 I 1...8 I 16	8 Q 1...8 Q 8	8 R 1...8 R 16	8 S 1...8 S 8	8 RN 1...8 RN 32	8 SN 1...8 SN 32		



Station	Basic device via NET		Local expansion via NET		Bit data via NET		Word data via NET	
	Input nI	Output nQ	Input nR	Output nS	Input nRN	Output nSN	Receive	Send
5	1 I 1...1 I 16	1 Q 1... Q 8	1 R 1...1 R 16	1 S 1...1 S 8	1 RN 1...1 RN 32	1 SN 1...1 SN 32	GT 1	PT 1
	...	...	...	...	...	...	...	...
	4 I 1...4 I 16	4 Q 1...4 Q 8	4 R 1...4 R 16	4 S 1...4 S 8	4 RN 1...4 RN 32	4 SN 1...4 SN 32	16	16
	6 I 1...6 I 16	6 Q 1...6 Q 8	6 R 1...6 R 16	6 S 1...6 S 8	6 RN 1...6 RN 32	6 SN 1...6 SN 32		
	7 I 1...7 I 16	7 Q 1...7 Q 8	7 R 1...7 R 16	7 S 1...7 S 8	7 RN 1...7 RN 32	7 SN 1...7 SN 32		
8 I 1...8 I 16	8 Q 1...8 Q 8	8 R 1...8 R 16	8 S 1...8 S 8	8 RN 1...8 RN 32	8 SN 1...8 SN 32			
6	1 I 1...1 I 16	1 Q 1...1 Q 8	1 R 1...1 R 16	1 S 1...1 S 8	1 RN 1...1 RN 32	1 SN 1...1 SN 32	GT 1	PT 1
	...	...	...	...	...	...	...	...
	5 I 1...5 I 16	5 Q 1...5 Q 8	5 R 1...5 R 16	5 S 1...5 S 8	5 RN 1...5 RN 32	5 SN 1...5 SN 32	16	16
	7 I 1...7 I 16	7 Q 1...7 Q 8	7 R 1...7 R 16	7 S 1...7 S 8	7 RN 1...7 RN 32	7 SN 1...7 SN 32		
	8 I 1...8 I 16	8 Q 1...8 Q 8	8 R 1...8 R 16	8 S 1...8 S 8	8 RN 1...8 RN 32	8 SN 1...8 SN 32		
7	1 I 1...1 I 16	1 Q 1...1 Q 8	1 R 1...1 R 16	1 S 1...1 S 8	1 RN 1...1 RN 32	1 SN 1...1 SN 32	GT 1	PT 1
	...	...	...	...	...	...	...	...
	6 I 1...6 I 16	6 Q 1...6 Q 8	6 R 1...6 R 16	6 S 1...6 S 8	6 RN 1...6 RN 32	6 SN 1...6 SN 32	16	16
	8 I 1...8 I 16	8 Q 1...8 Q 8	8 R 1...8 R 16	8 S 1...8 S 8	8 RN 1...8 RN 32	8 SN 1...8 SN 32		
8	1 I 1...1 I 16	1 Q 1...1 Q 8	1 R 1...1 R 16	1 S 1...1 S 8	1 RN 1...1 RN 32	1 SN 1...1 SN 32	GT 1	PT 1
	...	...	...	...	...	...	...	...
	8 I 1...8 I 16	8 Q 1...8 Q 8	8 R 1...8 R 16	8 S 1...8 S 8	7 RN 1...7 RN 32	7 SN 1...7 SN 32	16	16

**NET operands nI.., nR.., nQ.. and nS..**

The following NET operands can be written to and/or read.

**Reading of nI.., nR.., nQ.. and nS..**

n = NET ID of the station with NET operands that are read or written.

h

The operands \*RN.. and \*SN.. are always NET operands and must only be used with the preceding NET ID as nRN.. and nSN... The NET operands are only available in the standard circuit diagram. Placing a NET ID in front of the operand is explained on page 551. Without a preceding NET ID, the circuit diagram test SAFETY TEST will report that Rule 29 has been broken (a section "Rules in the safety circuit diagram", page 344).

Each NET station with a standard circuit diagram can read the signal states at the input and output terminals of each other NET station via these operands wired as contacts. This is possible regardless of whether a circuit diagram is being processed or not on the NET station to be read.

Use these nI.., nR.., nQ.. and nS.. NET operands to read the signal states of NET stations (NET-ID 2 - 8).

### Setting the NET ID of a NET operand

Requirement: You must have selected an I., R., Q., R., RN., S. or SN.. operand in the standard circuit diagram and Entry mode must have been selected.

I 01  
L: 1 C: 1 B: 7732

This mode is displayed by a flashing operand.

X Use the cursor buttons to move the cursor to the position to the left of the operand. A flashing zero appears as the initial value.

7I 01  
L: 1 C: 1 B: 7732

Enter the cursor buttons or to define the required NET ID; in this case NET ID 7.

Confirm the entry with the OK button.

The local I., R., Q. or S. operand has been changed to a NET operand nI., nR., nQ. and nS...

The following figure shows how the IS../QS. inputs/outputs of an easySafety device are assigned to the nI.. and nQ.. NET operands.

Table 28: Reading inputs/outputs IS../QS. of a easySafety device in the standard circuit diagram of another station via the NET (see also figure 283)

Input in the standard circuit diagram	easySafety input with NET ID n	Output in the standard circuit diagram	easySafety output with NET ID n
nI	IS	nQ	QS/QR
n I 1	q IS1	n Q 1	q QS1
...	...	...	...
n I 14	q IS14	n Q 4	q QS4
		n Q 7	q QR1

j

### Danger!

The safety inputs and outputs of an easySafety device operating as a NET station can be read in the standard circuit diagram of another NET station, however, they lose their safety properties.

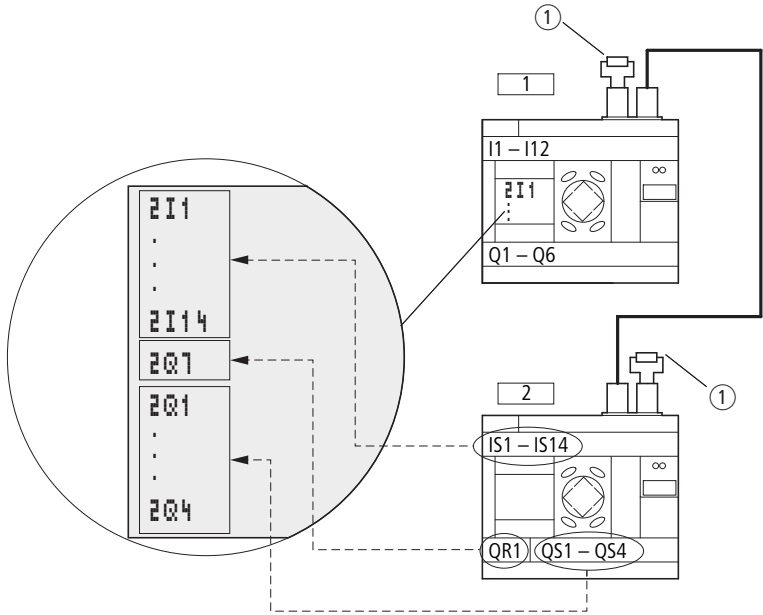

Figure 283: Using the inputs and outputs of an easySafety device in the standard circuit diagram of a different station

- ① Bus termination resistor
- Station 1 = easy800, Station 2 = easySafety

Example of how to read an IS.. input of an easySafety device:

A NET station is required to read data from input IS14 of NET station 4 via the NET in a standard circuit diagram and buffer it in its marker M01.

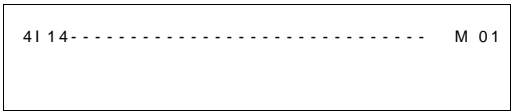

Figure 284: Standard circuit diagram for reading a safety input from a different NET station

**Writing of nQ.. and nS..**

Only NET station 1 has write access via the nQ.. and nS.. operands. It writes via coils nQ.. and nS.. to the output terminals of another NET station which is running in REMOTE IO mode without a circuit diagram.

Example 1:

NET station 1 is required to read data from input I1 of NET station 2 and write data to output Q1 of NET station 2. NET station 2 does not have a circuit diagram.

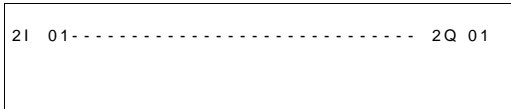

```
2I 01----- 2Q 01
```

Figure 285: Circuit diagram in NET station 1

### NET operands nRN.. (input) and nSN.. (output)

To use these NET operands, the sending and receiving station must each have a circuit diagram.

h

The operands \*RN.. and \*SN.. are always NET operands and must only be used with the preceding NET ID as nRN.. and nSN... The NET operands are only available in the standard circuit diagram. Placing a NET ID in front of the operand is explained on page 551. Without a preceding NET ID, the circuit diagram test SAFETY TEST will report that Rule 29 has been broken (a section "Rules in the safety circuit diagram", page 344).

The NET stations for bit exchange must always use the RN and SN in pairs (a figure 286 and 287).

#### Writing via SN

The NET operand SN (**S**end **N**ET) is used for sending bit data from one NET station to another. To do this you select the SN operand in a coil field.

#### Reading using RN

The RN (**R**eceive **N**ET) NET operand is used to receive the bit data that another NET station has sent. To do this you select the RN operand in a contact field.

#### SN-RN combination

As the RN and SN must always be used in pairs, the following rule applies:

- on the sending station and receiving station use the same operand number for each SN/RN pair to be formed.
- in the circuit diagram of the sending station you set for the SN operand (coil) the station number (NET ID) of the receiving station.
- in the circuit diagram of the receiving station you set for the RN operand (contact) the station number (NET ID) of the sending station.

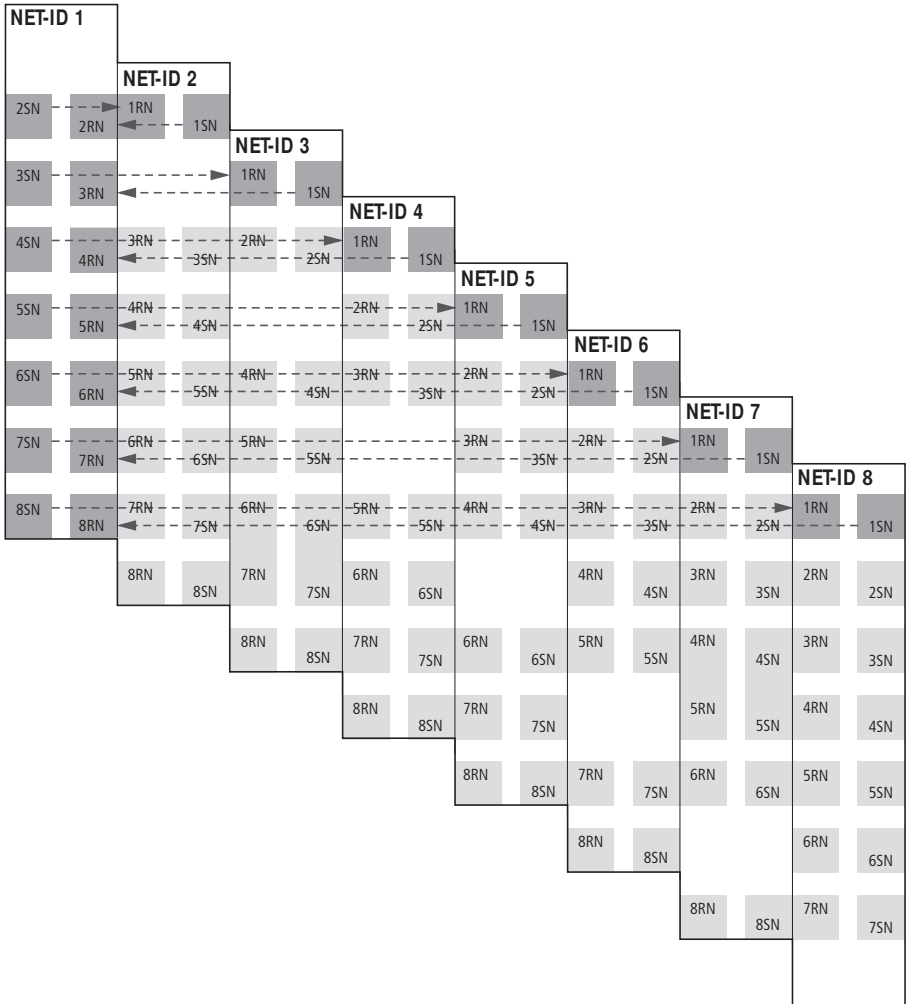

Figure 286: SN-RN combinations of NET station 1

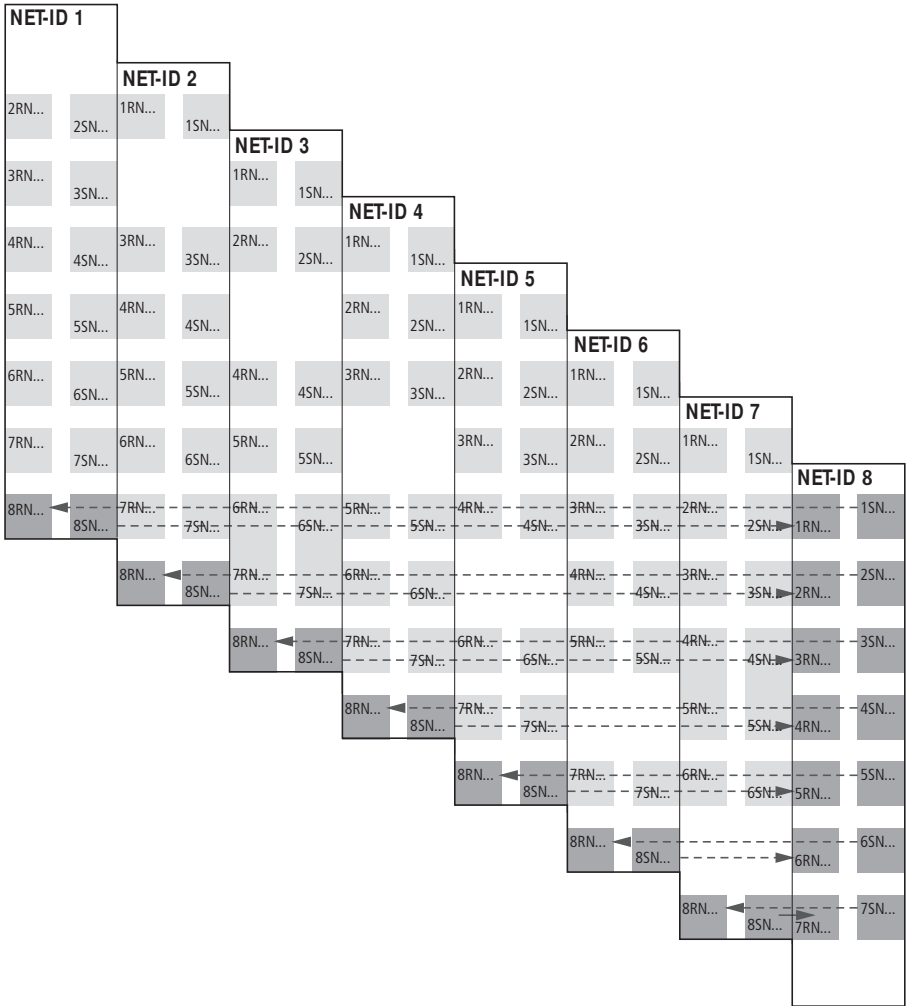
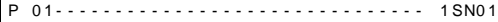

Figure 287: SN-RN combinations of NET station 8



**SN-RN example**

NET station 2 sends the status of the P button P01 via SN1 to NET station 1.



```
P 01----- 1 SN01
```

On NET station 1 the status of P1 is associated via RN01 as a count pulse for the counter relay C01.

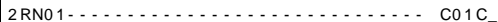

```
2 RN01----- C01 C_
```

**NET operand GT.. (receive), PT.. (send) and SC.. (set date and time)**

The function blocks are of data type 32-bit. On easySafety devices you can use up to 16 GT and 16 PT function blocks in the standard circuit diagram. They only function if the NET is operating correctly (a section "Checking the functionality of the NET", page 543).

**GT..**

The GET function block GT.. allows you to read a specific 32-bit value from the NET. The GET function block fetches the data automatically as soon as it is provided on the NET by another NET station using the PUT function block. The receipt of new data is indicated by status 1 at output Q1 for one cycle.



```
GT01 Q1----- DB16 T
```

Figure 288: easySafety circuit diagram with GET function block

Further information on the GET function block can be found on page 242.

**PT..**

The PUT function block PT.. enables you to transfer the value of an operand to the NET. The maximum length of this operand value is 32 bits.

A rising edge at the T\_ input initially buffers the value set at I1 and then transfers it to the NET.

The operand value is transferred and automatically read by the corresponding GET function block of another NET station.

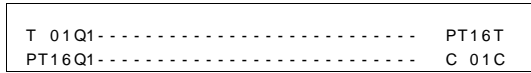

Figure 289: easySafety circuit diagram with PUT function block

Further information on the PUT function block can be found on page 293.

**Description of the NET-  
PARAMETERS**

The NET parameters described below can be found in the NET PARAMETERS menu:

X Simultaneously press the DEL and ALT buttons with the status display active. Then choose STD PARAMETERS -> CONFIGURATOR -> NET -> NET PARAMETERS and press the OK button.

**NET ID (Station number)**

Factory setting NET ID = 00.

Selectable NET IDs 1 - 8.

The NET ID of a device is used to give it a unique identification on the NET. A NET ID can therefore only be assigned once within a network.



The factory setting NET ID 00 prevents the possibility of double addressing when an existing NET station (NET ID 1-8) has to be replaced.

**BAUD RATE**

Data transfer rate of the NET

Factory set baud rate = 125 KB.

The devices allow a NET transfer speed of 10 - 1000 Kbaud, selectable in defined steps. Possible baud rates are: 10, 20, 50, 125, 250, 500 and 1000 KB

X Use  and  to select a baud rate of 10 - 1000 KB and confirm your selection with OK.

**h**

All NET stations must have an identical transfer speed set. This is achieved automatically if you carry out the NET configuration via NET station 1 (a  page 533).

The maximum transmission speed depends on the total length of the network cables (a  Technical data, section "Network easyNet" on page 669).

h

The reaction speed of devices connected via the NET depends essentially on the baud rate, the delay time and the volume of transferred data.

Therefore always set the maximum transfer speed. The factory set baud rate depends on the total length of the network cables of 125 m.

A maximum baud rate is therefore very important if an MFD-Titan is required to work on the NET since additional NET transfer time is needed.

**BUS DELAY**

(Bus delay time)

Factory setting: Bus delay time = 0 (recommended setting that you should only change for the reasons stated below).

Use BUS DELAY to change a multiplier that increases the bus delay time [tp] between the transmission cycles of user data in the NET.

- A value 1 means that the bus delay time is doubled.
- A value 15 means that the bus delay time is increased tenfold.

h

All NET stations must have an identical bus delay time set. This is achieved automatically if you carry out the NET configuration via NET station 1 (a section "Configure NET" on page 536).

X If necessary, use and to set a multiplier of 1 - 15 and confirm your selection with OK.

$$tp_{new} = tp \times (1 + n)$$

tp<sub>new</sub> = new bus delay time

tp = bus delay time determined by the network

n = Value at BUS DELAY

In normal operation, the NET stations organise their data exchange independently. The NET stations also determine the minimum delay time required so that all messages can be sent.

Even if a maximum baud rate is set, it may be necessary to increase the bus delay time for the following reasons:

- In addition to the user data, additional data is transferred to the PC, i.e. to easySoft-Pro in online status or to an MFD-Titan in terminal mode.
- The transfer rate is low.

By increasing the bus delay time you increase the time window for online services such as the power flow display, status display of actual values of function block operands and the forcing of markers.

An increase of the bus delay time is only really necessary in the following conditions:

- You use an MFD-Titan in terminal mode via the NET and see the message "Connection establishment in progress..." In this case the bus delay time must be increased permanently.
- You wish to use the online services of the easySoft-Safety configuration software via the NET. In Communication View, however, you will receive the error message "Device not responding". This fault message appears if you wish to establish an online connection or are already online. In this case, a temporary increase of the bus delay time is useful. It should be reduced after commissioning.

Remember also that the easySoft-Safety configuration software displays status changes more quickly on the device if you select the maximum PC baud rate.

h

An increase in the bus pause time means that fewer messages (inputs, outputs, bit data, word data) are transferred per time unit.

The reaction speed of all devices connected via the NET depends essentially on the baud rate, the delay time and the volume of transferred data.

You should therefore retain the proposed bus delay of the multiplier 0!

**SEND IO**

(Send each change on the inputs/outputs)

Factory setting SEND IO = On

Activate the SEND IO if you require short reaction times to each status change on the input or output of a NET station (e.g. at 2I 02, 8Q 01, etc.). In addition to the cyclical data transfer, the status change will be sent to all other NET stations in a separate telegram.

NET stations without a circuit diagram send each status change of an input or output, without taking the SEND IO setting into account.

An activated SEND IO function will considerably increase the number of telegrams on the NET and can slow down the transfer of other user data.

SEND IO

h

If you are using a high-speed counter (e.g. CH01) with constantly changing input data in the circuit diagram of a NET station, SEND IO should be deactivated for this station. Otherwise the station changes at the counter input will unnecessarily increase the number of telegrams on the NET.

**REMOTE RUN**

(operating mode change according to the operating mode of the NET station with NET ID 1)

Factory setting REMOTE RUN = On

REMOTE RUN must be activated on NET stations with NET ID 2 - 8 which are required to automatically follow the operating mode change of the NET station with NET ID 1.

h

If you are currently setting the station with NET ID 1, the REMOTE RUN function is therefore not required and is not available here.

j

**Danger!**

Ensure that the automatic starting of easySafety will not cause the unwanted starting of machines and plants.

h

NET stations with a circuit diagram and a display only follow the operating mode change if the status display or a text is showing in the display on the device.

**REMOTE IO**

(Operation as input/output device, without own circuit diagram)

Factory setting REMOTE RUN = On

h

The operation of an easySafety device exclusively as an input/output device is not possible. For this reason the easySafety does not support the REMOTE IO function. The easySafety device can only be operated on the NET as a station with a circuit diagram. Accordingly, the outputs can only be written to via the standard circuit diagram of the respective device, and not by NET station 1 by using the nQ.. and nS.. operands.

If the REMOTE IO mode is switched on, and only if they do not have their own circuit diagram, the conventional NET stations with NET-ID 2 - 8 function as input/output devices.

h

By default all devices except easySafety are configured as input and output devices, which make their inputs and outputs available to the NET station with NET-ID 1. This has the advantage that devices can be used immediately as I/O devices, regardless of whether they have a display or not. You must only assign the NET-ID, baud rate and bus delay to this type of device.

As soon as you enter a circuit diagram on this kind of NET station with NET ID 2 - 8, the REMOTE IO function is automatically deactivated.

This prevents write access to the outputs of this kind of NET station, both locally from its own circuit diagram as well as from REMOTE station 1.

The standard settings for the input and output devices are:

```
SEND I O
REMOTE RUN
```



---

**Replacing a NET station**

If you wish to replace a NET station NT2 - NT8 in a running plant, you should take preparatory measures in order to ensure fault-free commissioning of this NET station.

**Example**

In a network run with a baud rate of 250 KB, the NET station NT7 is to be replaced.

If you are using a easySafety device as replacement that is still in its default state and does not have a NET-ID, this device is not automatically integrated in the network. Even connected to the power supply and the NET, the LED NET remains off. In this case a configuration can not be written to it with the configuration software easySoft-Safety (Communications view -> Device list field, NT7).

The following procedure ensures fault-free commissioning of the replacement device.

- X Connect the easySafety replacement device to the power supply and connect it at the same position to the NET as the device to be replaced.
- X Switch the device display of all NET stations to Status display.
- X Start the automatic configuration of the NET. The procedure is described in section "Configure NET" on page 536. However, you can also do this via the configuration software. As an alternative to the automatic configuration, you can also switch the power supply of the configured NET stations off and on.

All NET stations in the NET configuration will temporarily switch to STOP.

**Power supply failure on station with NET-ID 1**

If the power supply of the station with NET-ID 1 fails during operation or a factory reset is carried out on this station, the other NET stations can no longer be notified of the associated operating mode change. This also applies if the standard and safety circuit diagram stop due to a class A fault (see Behaviour of easySafety after a fault, a page 624).

NET stations with NET-ID 2 - 8 on which REMOTE RUN is activated therefore stay in RUN mode until the missing sign of life is detected. The time until the missing sign of life is detected depends on the baud rate and is from 180 - 9000 ms (a section "Diagnostics" , page 544). Up to this time, a NET station 2 - 8 operates with the data previously received via the NET.

The further behaviour of the NET stations 2 - 8 depends on whether REMOTE IO is also activated as well as REMOTE RUN:

- NET station 2 - 8 with activated REMOTE RUN  
This type of NET station sets the data received via the NET to zero. It retains its operating state and sets the diagnostics bit ID1 to 1 (see following safety measure).
- NET stations 2 - 8 with activated REMOTE RUN and REMOTE IO that function as input/output devices, i.e. without their own circuit diagram (does not apply for easySafety)

This type of NET station sets the data received via the NET to zero. It switches to the STOP mode if the device display is showing the Status menu. The device follows NET station 1 when it switches to RUN mode.

h

The easySafety device can only be operated on the NET as a station with a circuit diagram.

**Safety measure:** On every NET station with a program, monitor the diagnostics bits ID.. in order to detect a missing NET station as quickly as possible (a section "Diagnostics" , page 544).

## 8 easySafety Settings

All easySafety settings can only be carried out on models provided with buttons and LCD display.

Alternatively use the easySoft-Safety configuration software to complete all the settings via the software.

---

### Password protection

#### General information

Only authorised persons are permitted to access the configuration of a safety control relay. The configuration consists of the safety circuit diagram as well as the necessary device settings, which have an effect on machine safety.

The access authorisation is protected by password entries. Passwords are part of each configuration, both in the easySoft-Safety configuration software as well as in the device.

The passwords are required when making entries via the operating buttons of the device in the same way as when using the easySoft-Safety configuration software, for (offline) editing and for simulating a configuration or downloading one to the device.

h

The passwords that are currently assigned in the configuration software are required for offline editing.

For online access or operating the device directly, the device is the controlling system. In other words, as soon as access to a protected menu is required, the passwords of the device carrying out the examination must be available.

A device can only be accessed without password entry if it is a new easySafety control relay or a device that has been restored to its factory settings.

Password protection prevents access to different areas such as the CIRCUIT DIAGR., CLOCK or the serial INTERFACE. Further information on the areas concerned is provided on page 572.

h

A password entered in the easySafety device is transferred to the memory card with the circuit diagram, irrespective of whether it was activated or not.  
If this easySafety circuit diagram is reloaded from the card, the password is also transferred to the easySafety device and is activated immediately.

Ⓔ	PARAMETERS. .	+
	STD PARAMETERS.	-
	ACTIVATE PW	
	DELETE ALL	+

The device indicates protected menu areas by means of a symbol behind the menu item, as in the example shown. Unprotected areas are not indicated and remain accessible without a password.

easySafety provides three access levels for different functions, and these are explained in the following section:

+ requires the entry of the master password

l requires the entry of the safety password, alternatively the master password.

- requires the entry of the standard password, alternatively the master password

## Access levels

### Master password ( + )

The obligatory master password has the highest level and allows access to all functions. The editing of the safety circuit diagram in particular is only possible if the master password has been entered. Each easySafety device must have a master password. For this reason, you are requested to assign a master password when entering the safety circuit diagram for the first time. The easySoft-Safety configuration software works in the same way. For this the master password must be assigned in all cases when adding a device in Project View.

### Safety password ( | )

The safety password protects the viewing of the safety configuration. You can assign the password if required, for example, if you wish to protect your know-how. The safety password is also advisable if there is a danger of third-parties examining the safety configuration in order to bypass or manipulate it. Without the safety password, the safety configuration can be viewed at any time but not modified. The master password is always required in order to edit it.

If the safety password is assigned and if this is active, the printing or display of the safety configuration in the circuit diagram, communication and simulation views of easySoft-Safety is only possible if the safety or master password has been entered. The safety password does not allow the modification of the safety configuration.

**Standard password ( - )**

The standard password protects the viewing of the safety configuration. You can assign the password if required, for example, if you wish to protect your know-how. Without the standard password, the standard circuit diagram can be viewed or modified at any time.

If you have assigned the standard password, activated it and selected the CIRCUIT DIAGR. area (a page 572), the printing or editing of the standard configuration is only possible if the standard or master password has been entered. This applies to the display of the standard configuration in the circuit diagram, communication or simulation view of easySoft-Safety. Remember that you can protect certain areas of the standard configuration with the standard password. The standard password does not allow the modification of the safety configuration.

**Entering passwords**

You set up a password using the system menu, irrespective of whether the device is in RUN or STOP mode.

The password can consist of any number between 0 and 9. A value between 000001 and 999999 can be entered as a password.

**h**

Assign different master, safety and standard passwords. Repeat entries will cause the error message PASSWORD ALREADY ASSIGNED!

```
ENTRY
PASSWORD
-----
```

### Master and safety password

The master password (+) must have been assigned before the safety password is entered for the first time. Otherwise this will be requested automatically.

Alternatively, you can call the master password as well as the safety password (l) via the menus:

```
M PASSWORD. . .
S PASSWORD. . .
```

x Press DEL and ALT to call up the System menu. Enter first of all the S PARAMETERS menu and then enter the PROTECTION menu. Press OK.

x To set up the master password move to the M PASSWORD menu or the S PASSWORD to set up the safety password.

```
ASSI GN
M PASSWORD
-----
```

x Press OK once more to enter the password entry mode, in the left hand example, for the master password.

If a master or safety password has not been entered, the easySafety moves directly to the password display and shows six dashes: indicating that there is no password set.

x Press OK, six zeros will appear.

x Set the password using the cursor buttons:

- select position in the password,
- Select a value between 0 and 9.
- use to select other positions in the password as required and select a value between 0 to 9.

```
ASSI GN
M PASSWORD
  119345
```

x Press OK to save the new password. This also closes the entry screen.

**Standard password**

- X Press DEL and ALT to call up the System menu.
- X Start password entry via STD PARAMETERS -> PROTECTION.
- X Press the OK button and enter the STD PASSWORD.
- X Press OK once more to enter password entry mode.

```

ASSI GN
STD PASSWORD
  - - - - -
  
```

If a standard password has not been entered, the easySafetydevice moves directly to the password display in this case as well and shows six dashes: indicating that there is no password set.

- X Press OK to cause six zeros to appear.
- X Set the password using the cursor buttons:
  - select position in the password,
  - set a value between 0 to 9.
  - use to select other positions in the password as required and select a value between 0 to 9.

```

ASSI GN
STD PASSWORD
  957468
  
```

X Press OK to save the new password. This also closes the entry screen.

```

STD PASSWORD. . .
RANGE. . .
  
```

You must now select the standard areas that you wish to protect. To do this use the to select the AREA menu and press OK.

**Protecting special standard areas**

- X Press OK.
- X Select the function or the menu to be protected.
- X Press the OK in order to protect the function or the menu ( = protected).

```

CI RCUI T
DI AGR. . . .
PARAMETERS
CLOCK
  
```

```

I NTERFACE
DELETE PROGRAM
  
```



h

At least one area must be protected. In the default setting the standard circuit diagram is selected.

- **CIRCUIT DIAGRAM:** The password is applied to the standard circuit diagram as well as function blocks that are not enabled, a section "Changing standard function block parameters", page 167. This area also prevents the transfer of a standard circuit diagram from and to the memory card.
- **PARAMETER:** The PARAMETER menu is protected.
- **CLOCK:** Date and time are protected with the password.
- **MODE:** It is not possible to change the operating mode from RUN to STOP and vice versa using the operating buttons of the device concerned. The same applies for the Run/Stop buttons of easySoft-Safety.

j

### **Danger!**

This password protection does not prevent operating mode changes in the following cases:

- With REMOTE RUN activated the NET station 2-8 follows the operating mode change of the NET station with NET-ID 1, a section "Description of the NET-PARAMETERS" -> „REMOTE RUN" on page 563.
- Operating mode changes can also be triggered through local expansion units (communication modules).
- **INTERFACE:** Protects against access to the multi-function interface of this device. Data exchange via the easyNet is not affected. Take into account the restricting effect of a protected interface if you have to reset the easySafety device to factory settings (a section "Master password no longer known", page 578).
- **DELETE PROGRAM:** When this function is not activated, the question "DELETE PROG?" will appear if the standard password entry is entered incorrectly four times. This question does not appear if you activate this function and protect the DELETE PROGRAM area. However, it is no longer possible to make changes in protected areas if you have forgotten the password.

The password is now valid but not yet activated.

**Activating the password**

An already entered password can be activated in four ways in order to activate password protection:

- via the password menu (see below)
- automatically when the device is switched on again.
- automatically after a configuration is loaded.
- automatically if 30 minutes after unlocking
  - a telegram is not sent from easySoft-Safety via the multi-function interface.
  - a button is not actuated.

**Activating password via the password menu**

- X Enter the first page of the system menu and move to ACTIVATE PW.
- X Then press the OK button.

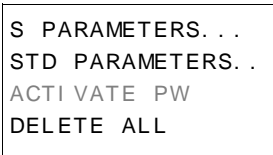

h

**Caution!**

If the master and standard password are unknown or lost and the interface was protected: The device can only be restored to factory settings at the manufacturer. The program and all data will be lost.

All passwords are now active. In other words, password protection is active.

Before you then activate a protected function or protected menu, you must unlock the device with the respective password or master password.

## Unlocking easySafety

Unlocking easySafety deactivates password protection. Which password is required where is indicated in the menu line by the character mentioned on .page 568 A password request starts up when a protected function is called. You can reactivate password protection later via the system menu or by switching the power supply off and on again.

h

For security reasons, only one password can be deactivated at a time. This means that you must enter the master password if you want to enable simultaneous access to the areas protected by safety and standard password. In this case, the safety configuration is not protected!

h

The function of an area is accessible if a password is entered to unlock an area. All other functions protected by this password are now also unlocked.

The procedure to unlock the configuration or parts of it is always the same. The unlocking of the safety circuit diagram for editing is therefore used as an example:

- x Press OK to enter the main menu from the status menu. This will cause the SECURITY menu to flash.
- x Press the OK button once more to enter the next submenu of the safety configuration. This will cause S PROGRAM to flash.

```
S PROGRAM. . .
S SAFETY TEST
T TEST SI GNALS. . .
```

As a safety password was not assigned in this example, the | symbol will not appear at the end of the S PROGRAM line.

- x Now press the OK button in order to view the safety circuit diagram.

```
ENTRY
PASSWORD
XXXXXX
```

If you then want to edit the safety circuit diagram (by pressing the OK button), the password entry dialog (see figure left). The safety circuit diagram is now protected from modification by the master password.

- x Press OK, six zeros will appear.

- X Now enter the master password.
- X Confirm your entry with OK.

You will be returned to the safety circuit diagram automatically and can edit this.

The device is fully unlocked and all functions can be accessed once the master password is entered.

## Changing passwords

- x Unlock the easySafety device as previously described.
- x Press DEL and ALT to call up the System menu.
- x Open the password menu, for example, via menu items S PARAMETERS -> PROTECTION -> M PASSWORD for changing the master password.

h

The safety password is changed in the same way via S PARAMETERS -> PROTECTION -> S PASSWORD. For this standard password use STD PARAMETERS -> PROTECTION -> STD PASSWORD.

```
CHANGE
M PASSWORD
XXXXXX
```

- x Press OK to enter the password entry menu.
- x Press OK to move to the 6-digit entry field.

The current password will be displayed.

```
CHANGE
M PASSWORD
254752
```

- x Modify the six password digits using the cursor buttons.
- x Confirm with OK.

Use ESC to close the entry screen.

```
ASSIGN
S PASSWORD
000000
```

## Delete password

- x Press DEL and ALT to call up the System menu.
- x Open the password menu to delete the password:
  - for the safety password via menu items S PARAMETERS -> PROTECTION -> S PASSWORD.
  - For the standard password use STD PARAMETERS -> PROTECTION -> STD PASSWORD.

h

The master password is protected specially and can therefore be changed but cannot be deleted!

If a password is not entered, the easySafety device shows six dashes. An existing password is displayed with XXXXXX.

- x Delete the safety or standard password by entering the value 000000.

**Standard password no longer known or incorrectly entered**

If you no longer know the standard password precisely, you repeat your password entry several times. If the DELETE PROG function is activated in the AREAS menu, the password can be entered as often as required.

ENTRY  
STD PASSWORD  
XXXXXX

Have you entered an incorrect standard password?

X Enter the standard password once more.

DELETE  
STANDARD  
PROGRAM?

On the fifth incorrect entry the easySafety device asks whether the password should be deleted, to which you reply with OK or ESC.

X Press OK.

Password protection for the standard configuration is removed. The easySafety device returns to the status display.

**h**

**Caution!**

The stored standard circuit diagram and all parameters of the easySafety device are lost.

X Alternatively press ESC.

Data is not deleted. Standard circuit diagram and data are retained. You can now start entry attempts once more.

**Master password no longer known**

If the master password is no longer available, you must restore the device to its default settings. This can be done in two ways:

- via the PC with easySoft-Safety, irrespective of RUN or STOP.
- by the manufacturer.

# h

**Caution!**

Both reset procedures remove all circuit diagrams, parameters and passwords.

**Reset with easySoft-Safety**

Requirement: You have opened the communication view and established the connection to the device (online).

x Select Communication -> Factory Reset.

x Enter the factory password CLEAR DEVICE.

The configuration is completely deleted.

# h

When the multi-function interface is protected, you cannot restore the device factory settings via easySoft-Safety. You must first open the protected interface using the master or standard password.

# h

If operating mode changes are protected, the only mode in which the device can be reset to default settings without entering the password is the STOP operating mode. In the RUN operating mode, you will first have to enable operating mode changes by entering the master password or standard password.

**Reset by the manufacturer**

Your local Eaton branch will be glad to offer you further help with the repair.

**Sealing the safety configuration**

The safety configuration is a part of the configuration. It consists of:

- the safety circuit diagram and its startup behaviour.
- the permission to overwrite from the card
- master and safety password.

**h**

If it is necessary to prevent the changing of a created safety configuration that has been tested and found to be correct and valid, it can be sealed and thus protected from any change.

- X Press DEL and ALT to call up the System menu.
- X Choose here S PARAMETERS -> SYSTEM -> S SEAL.

<p>SEALING IS NOT REVERSIBLE! OK- &gt;ACTIVATE ESC- &gt;CANCEL</p>
--

OK seals the safety configuration, ESC breaks the process and returns you to the menu.

The safety configuration and its system parameters are not protected from unwanted changes but can still be viewed. If modifications are required after sealing, a new safety configuration must be entered or loaded.

The sealing function has no effect on the standard configuration.



## Enabling overwriting from the card

The easySafety device is factory set to disallow the automatic overwriting of the newly entered safety configuration in the device with the configuration from the memory card. However, setting the system parameter TRNSF FROM CARD can allow this.

### j

#### Danger

Remember that by activating this function, the safety configuration can be overwritten from the card automatically. The master password does not offer any protection if a card with a different safety configuration is fitted.

Ensure that no unwanted safety configuration is transferred to the device. For example, this may occur by the accidental mixing of two memory cards.

If a new safety configuration is loaded to the device, you must check the safety equipment of your machine/plant and test it.

X Press DEL and ALT to call up the System menu.

X Choose S PARAMETERS -> SYSTEM to access TRNSF FROM CARD.

**SEAL SAFETY**  
TRNSF FROM CARD

X Press OK. The tick indicates that the configuration in the device is automatically overwritten from the card after the memory card is fitted and the operational voltage is switched on.

After a memory card is fitted, this system setting is checked after the device is switched on. If the TRNSF FROM CARD is activated , the existing configuration in the device is overwritten on the memory card.

If it is not activated, the existing safety configuration is not overwritten in the device. However, if the safety configurations on the device and on the card are identical, the standard configuration is transferred to the device.

The following table shows how the easySafety behaves according to the set function and the conditions shown when the power supply is switched on.

Table 29: Behavior on power supply switched on

Condition							Behaviour easySafety
Card fitted	Device in RUN	Device contains the configuration	Same safety configurations in the device and on the card	Allow automatic loading from card	Fault scenario 1: Error on card	Actual device type and selected device type on card identical	
Yes	No	No	No	No	No	Yes	easySafety configuration is loaded from card.
Yes	No	Yes	No	No	No	Yes	Configuration from card is not loaded and the old configuration is retained. easySafety cannot be started as long as the card is fitted in the device.
Yes	No	not relevant			Yes	not relevant	
Yes	No	not relevant			No	No	
Yes	No	Yes	Yes	No	No	Yes	easySafety configuration is loaded from card.
Yes	No	Yes	No	Yes	No	Yes	

## Changing the menu language

The easySafety device first provides three menu languages for selection which you can select via the system menu.

Language	Display
English	ENGLISH
German	DEUTSCH
Italian	ITALIANO

### h

Language selection is only available if the easySafety device is protected by a standard password.

French is also available as an alternative to the three menu languages in the device. This language is downloaded via easySoft-Safety. Depending on your selection, the download will overwrite one of the two existing languages, German or Italian. Menu language English is kept permanently in the device.

After the languages are transferred, select the menu language on the device as follows:

- x Press DEL and ALT to call up the System menu.
- x Select here the STD PARAMETERS -> MENU LANGUAGE... to change the menu language.

```
ENGLISH
DEUTSCH
FRANCAIS
```

The language selection for the first entry ENGLISH is displayed.

- x Use `←` or `→` to select the new menu language, e.g. French FRANÇAIS.
- x Confirm with OK. FRANÇAIS is provided with a tick.
- x Exit the menu with ESC.

```
PROTECTION...
SYSTEME...
LANGUE MENUS...
CONFIGURATEUR...
```

easySafety sets the new menu language.

Press ESC to return to the Status display.

The menu language setting is a device function. This means that when the configuration is deleted this does not result in the loss of the setting selected.

**Setting date and time**

The easySafety feature a real-time clock with date and time functionality. This allows the use of the time switch function blocks for implementing time switch functions.

If the clock is not set or easySafety is switched on after the battery back-up time has elapsed, the clock starts with the setting MI 1:00 01.05.2002. The easySafety operates with date and time so that hour, minute, day, month and year have to be set.

X Select SET CLOCK... from the main menu.  
This will open the menu for setting the time.

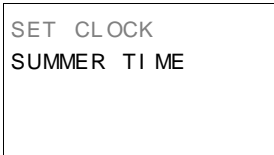

X Choose SET CLOCK here.

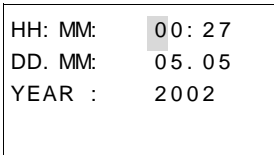

X Set the values for time, day, month and year.

X Press OK to activate Entry mode:

- Select the position.
- Change the value of a parameter
- OK: Save day and time
- ESC: Retain previous setting.

Press ESC to leave the time setting display.

**Changing between winter/  
summer time (DST)**

The easySafety models are fitted with a real-time clock. These devices can be automatically switched between summer and winter time.

**h**

The DST setting you have made is always associated with of the configuration. If you are commissioning easySafety-controlled plants worldwide, it may be necessary to also set and store this configuration with the regional time settings.

For these kinds of easySafety devices for worldwide use, use the "Rule" option for a DST setting.

The following options are available for setting DST parameters:

- NONE: No DST setting.
- MANUAL: User-defined daylight saving time setting.
- EU: Date for European Union; Start: Last Sunday in March; End: Last Sunday in October.
- GB: Date for United Kingdom (the rules of the European Union now apply to GB); Start: Last Sunday in March; End: Last Sunday in October.
- US: date defined in the United States of America: Commences: second Sunday in March; Ends: first Sunday in November.
- RULE: User-defined dates and changeover times as well as time difference selectable between 0 and 3 hrs; can be set in stages of 0.5 hrs.

### Setting DST parameters

Select SET CLOCK... from the main menu and press OK.



This will open the menu for setting the time.

X Select the DST menu and press OK.

The time change option is shown in the next menu.

### Selecting the DST setting option

The standard setting is NONE for automatic DST changeover ( at NONE).

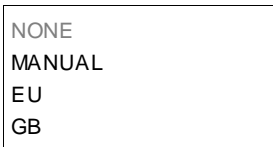

X Select the required option for the DST setting and press OK.

US  
RULE

### Manual option

To set your own date.

h

---

Manual parameterization of the daylight saving time changeover is recommended **only** for easy800 devices with a device version number of 04 or less. Later easySafety devices can be more easily parameterized with the "Rule" option if you can not use any of the regional default settings.

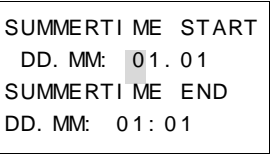

X Change to the MANUAL menu and press OK 2 x .

- Select the position.
- Change the value.
- Press OK to save day and time or press ESC to restore the previous setting.

X Press ESC to leave the display.

X Select the day and the month on which the summer time is to start.

X Select the day and the month on which the summer time is to end.

h

The same time for conversion applies as for the legally specified variants for EU.

#### “EU”, “GB” or “US” options

- x Move to one of the EU, GB or US menus and press OK.
- x Exit the menu with ESC.

The time setting is active and the easySafety device switches to the following times according to these regional presets:

The following applies to the winter h → summer time change with the regional presets EU, GB or US: On the changeover day the clock will switch from 2:00 to 3:00.

The following applies to the summer h → winter time change with the regional presets EU or GB: On the changeover day the clock will switch back from 3:00 to 2:00. US: On the changeover day the clock will switch back from 2:00 to 1:00.

#### Rule option

h

If you create a rule in the rule editor of the easySoft-Safety, you can access the national time scenarios provided on a row. These include possible worldwide time scenarios both for the northern and for the southern hemisphere. In special cases you can create your own special rules based on these.

```
SUMMERTIME START
SUMMERTIME END
```

- x Change to the RULE menu and press OK.
- x Change to the SUMMER TIME START and press OK.

The flashing cursor is located in line 1, column 1 on the word ON.

```
ON LAST SU
OF MONTH 03
AT 02:00
DIFF: + 1:00
```

- x Press OK gain to move to Entry mode in order to set the changeover day parameters for summer time.
- x Use cursor buttons or to set day 1 to 4 or the last day and press OK.
- x Position the cursor in succession with the or buttons at the required entry locations and change the Weekday parameter (SO), Month (OF xx. Month), Time (AT

xx:xx) or the time difference (DIFF:.) as previously described for the changeover day.

- X Press ESC to exit the SUMMER TIME START and choose SUMMER TIME END.
- X Set the changeover data to winter time as previously described for the changeover day to summer time and exit the menu with ESC.

The time difference (DIFF:.) parameter corresponds to the entry for the changeover day to summer time and cannot be changed in this menu. The easySafety device now alternates between summer and winter time according to your rule.



---

**Activating/deactivating  
DEBOUNCE**

The easySafety device is factory set to evaluate input signals with an input delay, the so-called DEBOUNCE function. This ensures that any contact bouncing of switches and pushbuttons is masked out.

However, for many applications, it is necessary to evaluate very short input signals. In this case, it is possible to deactivate the debounce for each input individually as required.

- x Press DEL and ALT to call up the System menu.
- x Change to the system menu via STD PARAMETERS and choose the DEBOUNCE menu item.

## h

---

If the easySafety device is protected with an STD PASSWORD, you must remove password protection before you can call the system menu.

P BUTTONS  
RUN MODE  
DEBOUNCE. .  
DI SPLAY

**Activating DEBOUNCE**

- x To activate **DEBOUNCE**, choose **DEBOUNCE** and press OK.

The menu for selective debounce settings opens in which you can activate or deactivate the debounce for each individual input.

DEBOUN. ALL ON  
DEBOUN. ALL OFF  
I S01  
I S02

- x Use the cursor buttons or to select the required DEBOUNCE setting and press OK.

The debounce is activated.

## h

---

**Caution!**

Debounced inputs may not be used in the safety circuit diagram.

- x Press ESC to return to the previous menu.

### Deactivating DEBOUNCE

If menu I-DEBOUNCING displays inputs with a checkmark (for example IS7 ), I-debouncing is enabled for this input. To disable I-debouncing, select the input and click ok.

The debounce is deactivated and the display changes to an input number without a tick.

h

How easySafety input signals are processed internally is explained in section "Input delay (debounce)", page 609.

### Activating and deactivating the P buttons

If you have used cursor buttons (P buttons) as pushbutton inputs, these are not automatically active. In this way, the cursor buttons are protected against unauthorised actuation. The P buttons can be activated in the System menu.

h

If easySafety is protected with a password, you must remove password protection before you can call the system menu.

The P buttons are activated and deactivated via the P BUTTONS menu.

P BUTTONS  
RUN MODE  
DEBOUNCE. .  
DI SPLAY. . .

- X Press DEL and ALT to call up the System menu.
- X Change to the system menu via STD PARAMETERS.
- X Move the cursor to the P BUTTONS menu.

P	BUTTONS
RUN	MODE
DEBOUNCE	
DI	SPLAY. . .

### Activating the P buttons

If is displaying easySafety P BUTTONS , this means that the P buttons are active.

x Otherwise select P BUTTONS and press OK.

easySafety changes the display to P BUTTONS and the P buttons are activated.

x Press ESC to return to the status display.

**h**

---

The P buttons are only active in the status display and the text display. In this display you can use the P buttons to activate inputs in your circuit diagram.

### Deactivating the P buttons

x Select P BUTTONS and press OK.

The tick behind P BUTTONS disappears and the P buttons are deactivated.

**h**

---

When deleting a circuit diagram in the easySafety-device, the P buttons are deactivated automatically.

---

## Startup behaviour

The startup behavior is an important aid during the commissioning phase. The configuration contained in the easySafety is not fully wired and parameterized. Or the plant/machine is in a state that easySafety cannot control. If easySafety is then switched on, it should not be possible to activate the outputs.

### Setting the startup behaviour

h

To change to RUN mode without using the configuration software the startup behaviour RUN START must be enabled for easySafety devices without display.

Requirement: easySafety must contain a valid configuration.

X Change to the system menu via -> STD PARAMETERS -> SYSTEM.

h

If easySafety is password protected, easySafety the system menu area cannot be accessed until has been unlocked (a section "Unlocking easySafety", from page 575).

Set whether easySafety should start in RUN or STOP mode when the power supply is switched on.

**Activating RUN mode**

If easySafety shows RUN START , easySafety starts in RUN mode when the supply voltage is switched on. If the device does not contain a circuit diagram, it remains in operating mode STOP.

P BUTTONS  
 RUN MODE  
 DEBOUNCE. . .  
 DI SPLAY

X Otherwise select RUN MODE and press OK.  
 RUN mode is activated.

X Press ESC to return to the status display.

h

After the device power supply is switched on, easySafety switches to RUN mode after approx. 7 seconds.

P BUTTONS  
 RUN MODE  
 DEBOUNCE. . .  
 DI SPLAY

**Deactivating RUN mode**

X Choose CARD MODE and press OK.  
 The RUN mode function is deactivated.

The easySafety is factory set to show RUN START on the display; i.e. easySafety switches to RUN mode when the power supply is switched on without a memory card fitted.

Menu displayed	Status of easySafety after startup
RUN MODE	easySafety is in STOP mode
RUN MODE	easySafety switches to RUN mode

### Behaviour when the circuit diagram is deleted

The setting for the startup behaviour is an easySafety device function. When the circuit diagram is deleted this does not result in the loss of the setting selected.

### Behaviour during upload/download to card or PC

The setting is retained if a valid circuit diagram is transferred from easySafety to a memory card or PC. This also applies in the opposite direction, i.e. from the memory card or PC to the easySafety.

h

The easySafety devices without a display can only be started in RUN mode.

### Possible faults

easySafety will not start in RUN mode:

- A program is not available in easySafety.
- You have put easySafety in STOP mode (RUN MODE menu).

## Setting contrast and backlight

The background illumination of the LCD display can be switched off. The display contrast can be set to one of five stages. The display is not required during operation. The backlight only needs to be active during maintenance operations or when texts have to be displayed.

If the backlight is switched off, it will switch back on when a button is pressed. The backlight switches off automatically 60 s after a button was last pressed.

The contrast and backlight settings are device settings.

x Switch to the system menu.

h

If easySafety is password protected, the system menu cannot be accessed until easySafety has been unlocked (a section "Unlocking easySafety", from page 575).

x In the system menu choose STD PARAMETERS -> SYSTEM -> DISPLAY and press OK.

CONTRAST:  
LI GHTI NG 0

The menus for setting the contrast and backlight are displayed.

x Press the OK button and change the contrast setting.

CONTRAST:  
LI GHTI NG +1

x Use the cursor buttons and to set a contrast between -2 and +2 and press OK to confirm the setting.

The contrast setting is valid until it is changed again.

CONTRAST:	+ 1
LI GHTI NG	

X Use the cursor buttons and to enter the LIGHTING menu.

X Press the OK button to define whether the backlight is to be activated or deactivated.

CONTRAST:	+ 1
LI GHTI NG	

The tick indicates that the backlight is activated.

### h

The default setting of easySafety is as follows:

- The contrast is set to 0.
- The backlight is permanently activated. Menu setting: LIGHTING . The backlight is set to 75 %.



---

**Retention**

Plant and machine controls require the possibility to retentively set operating states or actual values, i.e. the values should be retained safely even after the power supply of a machine or plant has been switched off and should be left unchanged until the actual value is overwritten.

The following operands and function blocks of the standard circuit diagram can be set retentively:

- Markers.
- Counter function blocks.
- Data function block.
- Timing relays.

**Hours-run counter**

**easySafety** features 4 retentive operating hours counters. They are always retentive and can only be selectively deleted with a reset command.

**Data volume, retentive data**

The maximum memory range for retentive data is 200 bytes (operating hours counters are not included).

**Markers**

A user-definable and contiguous marker byte range can be declared as retentive.

**Counters**

All C.. function blocks can be operated with retentive actual values.

**Data function blocks**

A user-definable consistent function block DB range can be operated with retentive actual values.

**Timing relays**

A user-definable and contiguous range for timing relays T can be run with retentive actual values.

**Requirements**

In order to make data retentive, the relevant markers and function blocks must have been declared as retentive.

# h

### Caution!

The retentive data is stored every time the power supply is switched off and read when the power supply is switched on. The data security of the memory is guaranteed for 10<sup>10</sup> write-read cycles.

### Setting retentive behaviour

Requirement:

easySafety must be in STOP mode.

X Switch to the system menu.

# h

If easySafety is password protected, the system menu cannot be accessed until easySafety has been unlocked (a section "Unlocking easySafety", page 575).

The factory setting of easySafety is for retentive actual values. If easySafety is in STOP mode or the power supply is switched of, all actual values are cleared.

```

RUN MODE
DEBOUNCE. .
DI SPLAY. . .
RETENTI ON. . .

```

X Switch to STOP mode.

X Switch to the system menu.

X Enter the system menu via STD PARAMETERS and then on to the RETENTION... menu.

X Press the OK button.

```

MB 00 -> MB 00
C 00 -> C 00
DB 00 -> DB 00
          B: 200

```

The first screen that appears is a selection dialog for operand marker bytes (MB). The display on the lower right B: 200 indicates the number of free bytes.

X Use to select the operand.

X Press OK to access the Entry modes.

- Select position from to,
- Set a value.

MB 01 -> MB 04
C 12 -> C 16
DB 01 -> DB 16
B: 076

RETAIN MARKERS

T 08 -&gt; T 14

If required, select the next operand. In all, you can select six different operand ranges.

Example:

MB 01 to MB 04, C 12 to C 16, DB 01 to DB 16, T 08 to T 14 should be retentive.

124 bytes have been assigned to the retentive data range.  
76 bytes are still available.

x Save the entry from .. to .. with OK.

Press **ESC** to exit the input for the retentive ranges.

### Deleting areas

Set the ranges to be erased to the values from 00 to 00.

e.g.: MB 00 -> MB 00. The markers are no longer retentive.

## Deleting retentive actual values of markers and function blocks

The retentive actual values are cleared if the following is fulfilled (applies only in STOP mode):

- When transferring the circuit diagram from the easySoft-Safety (PC) or memory card to the easySafety, the retentive actual values are reset to 0, provided that the RETAIN MARKERS option has not been selected. This also applies when there is no program on the memory card; in this case the old circuit diagram is retained in easySafety.
- When changing the respective retentive range.
- When the circuit diagram is deleted via the DELETE PROG menu.

## Retain retentive markers during transfer

Selecting the RETAIN MARKERS option tells the device that it must handle the retentive markers as recipe markers. This means that the states of these markers are not changed by a configuration transfer (using the configuration software or the external memory card) nor by editing the circuit diagram on the device.

However, the retentive markers will be cleared in the following circumstances even if the RETAIN MARKERS option is activated:

- if the DELETE ALL item in the device's System menu is selected;
- if the retentive marker ranges are changed with the device's System menu item STD PARAMETERS..., SYSTEM..., RETENTION...;
- if the retentive marker range has been modified through a transfer from the configuration software or the external memory card.

### **Transferring retentive behaviour**

The retentive behaviour setting is a standard circuit diagram. In other words, the setting of the Retention menu is included in any transfer on the memory card or when uploading/downloading to/from the PC.

### **Changing the operating mode or the standard circuit diagram**

The retentive data is normally stored with its actual values when the operating mode or the easySafety standard circuit diagram is changed. The actual values of no longer used relays are not retained.

### **Changing the operating mode**

If you change from RUN to STOP and then back to RUN, the actual values of the retentive data will be retained.

### **Changing the easySafety standard circuit diagram**

The actual values are retained if the easySafety circuit diagram is changed.

### **Changing the startup behaviour in the SYSTEM menu**

The retentive values in easySafety are retained irrespective of the setting.

### **Modification of the retentive range**

If the set retentive ranges are reduced, only the actual values saved in the range will remain.

If the retentive range is extended, the older data is retained. The new data is written with the current actual values in RUN mode.



## 9 easySafety internal

---

**easySafety circuit diagram** In conventional control systems, a relay or contactor control processes all the rungs in parallel. The speed with which a contactor switches is thus dependent on the components used, and ranges from 15 to 40 ms for relay pick-up and drop-out.

With easySafety the circuit diagram is processed with a microprocessor that simulates the contacts and relays of the circuit concerned and thus processes all switching operations considerably faster. Safety and standard circuit diagrams are processed in succession from the beginning to the end. In this time, the easySafety device first runs through the six segments of the safety circuit diagram and then the six segments of the standard circuit diagram.

If the operands of the inputs and outputs are addressed in the easySafety configuration, the signal states of the digital inputs/outputs are not scanned but a memory range in the device system memory is accessed. This memory range is called the process image. The process image is divided into two sections: the process image for the inputs and the process image for the outputs.

### How the easySafety device evaluates the safety and standard circuit diagram as well as the function blocks

Safety circuit diagram

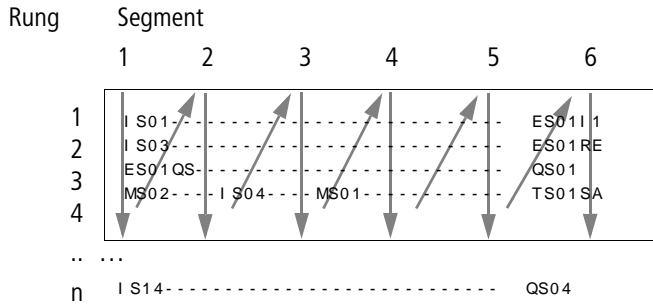

Standard circuit diagram

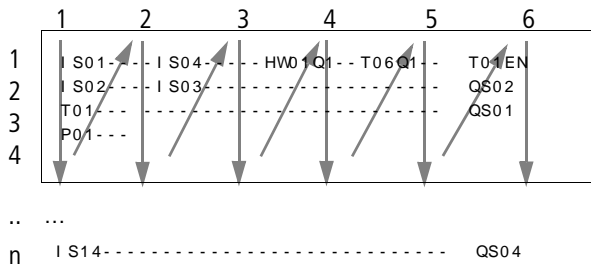

#### Segment 1 - 4

The easySafety device evaluates the contact fields within the first four segments. The evaluation starts in the first segment in circuit diagram line 1 of the safety circuit diagram and continues from top to bottom until circuit diagram line n is reached. The easySafety device then moves to the next contact segment and continues to evaluate from top to bottom until it has reached the last contact in the fourth segment.



**Segment 5**

In the fifth segment the easySafety device assigns all coils in one pass, from the safety circuit diagram line 1 - n, with the new switch states from the process image of the outputs.

**Segment 6**

The safety function blocks present are evaluated in the sixth segment which is outside of the circuit diagram.

If a standard circuit diagram was created, the easySafety device then passes through the six segments of this circuit diagram in the same order. The sixth segment the function blocks present in the function block list are then reevaluated.

The easySafety device uses this sixth segment in order to:

- process the existing function blocks.  
The easySafety device processes the safety function blocks in the order in which they were transferred to the safety circuit diagram, i.e. irrespective of their position in the circuit diagram. The output data of a function block is immediately up-to-date after it has been processed. The output data (32-bit) of a safety function block is processed in the standard circuit diagram. In this way you can represent the actual value output TS..QV of a safety timing relay function block on the device display using the D text display function block.  
The standard function blocks are processed by the easySafety device in the order of the function block list (a FUNCTION BLOCKS menu).

h

To change the order in which the standard function blocks are processed, for example, so that the output value of one function block can be used at the input of another standard function block, you can rearrange the function block with the easySoft-Safety programming software.

- to contact the "outside world"  
Output relays QS 1 to QS 4 or QR are switched and inputs IS 1 to IS 14 are re-read. For the expansion modules the S... output relays are switched and the R... inputs are read accordingly.

- to exchange easyNet data if this easySafety device receives new read data or provides new send data (a section "easyNet network" on page 521).
- to copy all new switching states to the process image.

The easySafety device uses a fixed process image that lasts for the duration of a cycle. This ensures that each rung is evaluated with the same switching states for one cycle, even if the input signals at IS1 to IS14, for example, change their status several times within a cycle.

### What you must consider when creating the circuit diagram

The easySafety device evaluates the circuit diagram in segments, and from top to bottom within a segment, from circuit diagram line 1 - n. You should therefore remember two points when you create your circuit diagrams.

- The changeover of a relay coil does not change the switching state of an associated contact until the next cycle starts.
- Always wire forward or from top to bottom. Never work backwards.

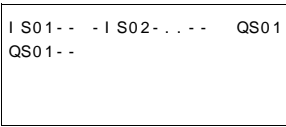

#### Example: Self-latching with own contact

Start condition:

Inputs IS01 and IS02 are switched on.

QS01 is switched off.

This is the circuit diagram of a self-latching circuit. If IS01 and IS02 are closed, the switching state of relay coil QS01 is "latched" via contact QS01.

**1 st cycle:** Inputs IS01 and IS02 are switched on. Coil QS01 picks up.

Switching contact QS01 remains off because the easySafety device processes the circuit diagram segment for segment from top to bottom and from left to right from the first segment. By the time the easySafety device refreshes the process image of the outputs and therefore the coil field with

QS0 1 in the fifth segment, contact field QS0 1 in the second line of the circuit diagram has already been processed.

**2nd cycle:** The self-latching only now becomes active. The easySafety device has transferred the coil states at the end of the first cycle to contact QS0 1.

**Example: Do not wire backwards**

In the third rung, the easySafety device finds a connection to the second rung in which the first contact field is empty. The output relay is not switched.

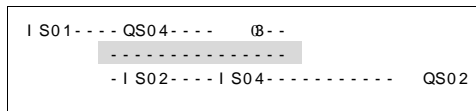

Figure 290: Circuit diagram with five contacts, invalid

h

Use one of the auxiliary relays MS.. if you have to connect more than four contacts in series.

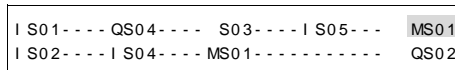

Figure 291: Circuit diagram with marker relay MS01

---

**Time behaviour of the inputs and outputs**

The reaction time, which is measured from the reading in of a digital input signal to the setting of the associated output, is determined by the timing characteristics of the device inputs and outputs as well as the size and design of the circuit diagram. How to estimate the reaction time is explained in section "Reaction time of an easySafety device", page 612.

**Filtering input signals < 1 ms**

Intelligent sensors (e.g. light curtains) can switch off their output signal for test purposes momentarily. Thus, an easySafety device filters out changes to input signals that are shorter than 1 ms.

**Time behaviour of easySafety transistor outputs**

A easySafety device switches the output signal at its transistor outputs momentarily for testing, i.e. from 1 to 0. The maximum off time is approx. 0.8 ms.

**h**

---

Take this off time into account when selecting the actuator that the easySafety device is to control.

**Input delay (debounce)**

The time required to switch the contacts in the circuit diagram can be increased on the easySafety device using an input delay, the so-called DEBOUNCE, a section "Activating/deactivating DEBOUNCE", page 589.

This function is useful, for example, in order to ensure a clean switching signal despite contact bounce.

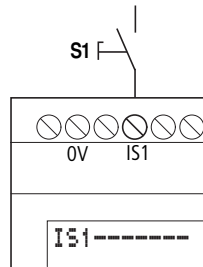

Figure 292: easySafetyinput assigned a switch

# h

**Caution!**

Debounced inputs may not be used in the safety circuit diagram.

### Delay time with DEBOUNCE activated

When DEBOUNCE is activated, the delay time for DC signals is 24 ms.

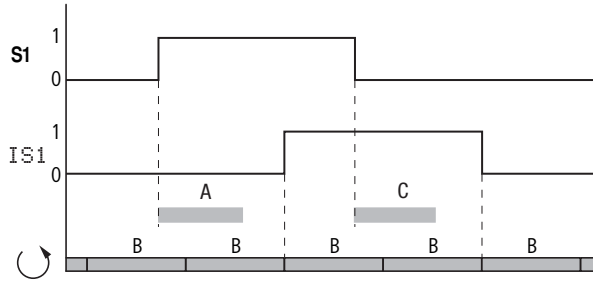

Figure 293: Delay times for evaluating an input signal and an activated DEBOUNCE

An input signal S1 must therefore be  $> 24\text{ V}$  on the input terminal for at least 15 ms before the switch contact will change from 0 to 1 (A). If applicable, this time must also include the cycle time (B) since a easySafety device does not detect the signal until the start of a cycle.

When the DC signal drops from 1 to 0 with DEBOUNCE active, the same delay time (C) of 24 ms applies.

**Delay time with DEBOUNCE deactivated**

When DEBOUNCE is deactivated, the typical delay time for DC signals on the input caused by the hardware lies between 0.06 (IS1, IS2) and 0.17 ms (IS3 - IS14) (A). The cycle time (B) must be added as well before the signal is safely detected in the circuit diagram.

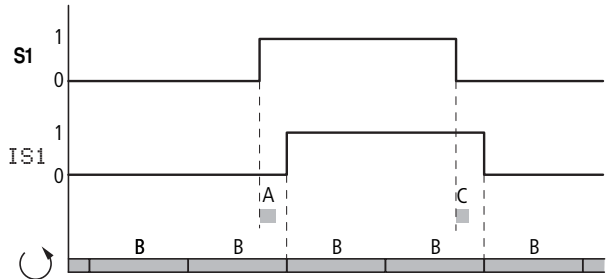

Figure 294: Switching behaviour with DEBOUNCE deactivated

h

When DEBOUNCE is deactivated ensure that input signals are free of noise. The easySafety device responds to very short signals.

h

To allow reliable recognition and processing of the input signal, it must be applied stably for a certain duration, the length of which depends on the circuit diagram processing cycle time.

For a guide to estimating the required minimum duration, see Table 30 „Maximum circuit diagram processing time as a function of the number current rungs“ on page 613.

The rule-of-thumb is: Minimum duration if an input signal = max. circuit diagram processing time  $\cdot 0.5$ .

---

**Reaction time of an easySafety device**

The easySafety reaction time of the device is often required to calculate the time of your safety application. For example, you need this if you have to calculate the distance between a separating or non-separating guard and the hazardous area of a machine (see also EN 294/ISO 13852 and EN 811/ISO 13853).

The reaction time is calculated from the maximum circuit diagram processing time and the output delay. If, however, the maximum circuit diagram processing time is shorter than the error detection time of the easySafety device, which is 150 ms, the reaction time is calculated only from the error detection time and the output delay.

The output delay is:

- For transistor output (QS): 1 ms
- For relay output (QR): 50 ms (worst case scenario)

The circuit diagram processing times stated in Table 30 are worst case values. For example, two cycles are taken into account for the processing times to ensure that the actual input image is processed in the circuit diagram. These times may be actually be shorter, however they are never longer.

Only determine the reaction time for calculating your application in the following manner:

- X Determine the number of the last processed rung in your safety circuit diagram and in your standard circuit diagram respectively, and add both values together. The empty rungs located in front of the last processed rung, which you can use as comment aids, for example, are also added to the calculation.
- X Refer to Table 30 for the maximum circuit diagram processing time.

If the calculated circuit diagram processing time is shorter than the detection time of the easySafety device (150 ms), the following applies in regard to the reaction time:

Reaction time = 150 ms + output delay



- Transistor output:  $150 \text{ ms} + 1 \text{ ms} = 151 \text{ ms}$
- Relay output:  $150 \text{ ms} + 50 \text{ ms} = 200 \text{ ms}$

If the calculated circuit diagram processing time is longer than the detection time of the easySafety device (150 ms), the following applies in regard to the reaction time:

Reaction time = circuit diagram processing time + output delay

- Transistor output:  
circuit diagram processing time (ms) + 1 ms
- Relay output:  
circuit diagram processing time (ms) + 50 ms

Table 30: Maximum circuit diagram processing time as a function of the number current rungs

Number of circuit connections	Max. circuit diagram processing time <sup>1)</sup> [ms]
1 - 39	100
40 - 79	135
80 - 119	170
120 - 159	205
160 - 199	245
200 - 239	275
240 - 253	300

1) The maximum circuit diagram processing time is achieved under maximum load, i.e. the following conditions are applied to the maximum utilization of the system in addition to the configuration with safety and standard circuit diagram:

- Device in the NET with seven other stations.
- Maximum data volume on the NET through the use of the maximum number of PUT and GET standard function

blocks and clock synchronization with SC standard function blocks.

- Continuous communication through the multi-function interface for online status indication with easySoft-Safety.
- Continuous communication through the easyLink connection and a communication expansion device.
- Configuration with OM and ZM safety function blocks for frequency measurement, at a rotational frequency of 950 Hz.

### Example

I S09-----	ES011 1
I S10-----	ES011 2
I S13-----	ES01 RE
ES01 QS-----	QS01
	QS03

Figure 295: Circuit diagram in easySafety

- 1) The circuit diagram in easySafety has six rungs (five programmed rungs + an empty rung).
- 2) According to Table 30 the maximum circuit diagram processing time for this is 100 ms.
- 3) Since the calculated circuit diagram processing time is shorter than the error detection time, the following applies in regard to this device with transistor outputs:

**Reaction time** = error detection time (150 ms) + output delay (1 ms) = **151 ms**

**Diagnostics****Diagnostics using the ID diagnostics contact**

The easySafety devices use diagnostics outputs ID.. to provide information about its own operating state. This information is evaluated in the standard circuit diagram.

<b>Diagnostics contact</b>	<b>Error</b>
ID 01	Fault in easyNet station 1.
ID 02	Fault in easyNet station 2.
...	...
ID 07	Fault in easyNet station 7.
ID 08	Fault in easyNet station 8.
ID 09	Free
ID 10	Safety circuit diagram stopped due to fault (class B, a page 624).
ID 11	Free
ID 12	Free
ID 13	Free
ID 14	Fault in expansion unit.
ID 15	Free
ID 16	Free

### Diagnostics using the DG diagnostics function block

A DG diagnostics function block is used to evaluate the status/fault messages of an assigned safety function block and can initiate up to eight appropriate message texts (a chapter "Standard function blocks", „DG, diagnostics", page 237). For the meaning of the fault messages see Table 31 on page 618.

The diagnostics and safety function block can only be assigned with the easySoft-Safety configuration software in its standard circuit diagram or function block diagram. Here you also assign in a list a special status/fault message of the selected safety function block to each output Q1-Q8 of the DG function block.

Example using the safety function block ES, EMERGENCY-STOP:

- Assign the safety function block ES01 to the standard function block DG01.
- Assign the safety function block status "Wait for rising edge at Reset" (see figure) of the function block ES01 to the DG01Q1 output.

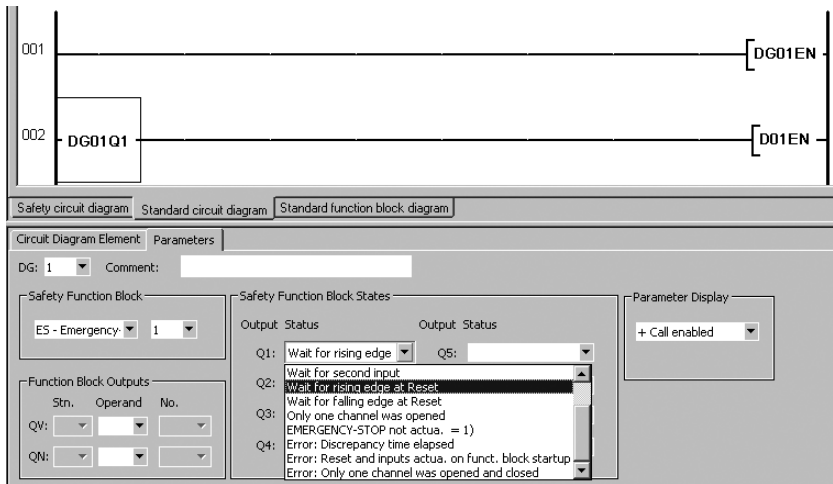

Figure 296: Assigning the diagnostics and safety function block with easySoft-Safety

In the standard circuit diagram, the contact DG01Q1 indicates with status 1 that the status "Wait for rising edge at Reset" is present on safety function block ES01.

With DG01Q1 set, you start the appropriate text output via the text output function block of an easySafety device, or alternatively via the easyNet to a message text screen element on an MFD-Titan. The text or message text must have been created beforehand. The example shows the Reset message using function block D01.

With the message text screen element you can also use the status code at output DG..QV (diagnostics register) as a status value for switching between different message texts.

### Diagnostics-/-Error codes

Table 31: Diagnostic /Failure code, sorted by status number

Status number		Plain text
Hexadecimal (0–F)	decimal (0-9)	
0000	0000	No Enable.
2001	8193	Enable issued; waiting for first (or only) input.
2002	8194	Waiting for second input.
2003	8195	Waiting for rising edge at Reset.
2004	8196	Waiting for falling edge at Reset.
2005	8197	Only one channel has been opened.
2007	8199	Waiting until feedback circuit closed.
2009	8201	Measurement started.
200A	8202	Operating mode can be selected.
200B	8203	Waiting for decreasing trigger signal; output not active.
200C	8204	timing element running, output not active.
200D	8205	Timer stopped; output not active.
200E	8206	Waiting for inputs during startup testing.
2011	8209	Foot switch not operated (position 1).
2012	8210	Enable switch in OFF position
2013	8211	Foot switch in panic position (position 3).
2014	8212	Undefined foot switch position
2015	8213	Waiting for activation of guard locking.
2016	8214	Two-hand pushbutton in normal position.
2017	8215	Two-hand pushbutton 1: undefined position.
2018	8216	Two-hand pushbutton 2: undefined position.
201A	8218	Activate test signals
201B	8219	Check test signals T1 and T2 Off

Status number		Plain text
Hexadecimal (0-F)	decimal (0-9)	
201C	8220	Check test signal T1 Off
201D	8221	Check test signal T2 Off
8001	32769	No fault detected in feedback circuit (QS = 1).
8002	32770	Switch in ON position (QS = 1).
8003	32771	Emergency-Stop not operated (QS = 1).
8004	32772	Foot switch operated (position 2).
8005	32773	Light curtain free (QS = 1).
8006	32774	Light curtain free (QS = 1).
8007	32775	Maximum speed not exceeded (QS = 1).
8008	32776	Start signal triggered (QS = 1).
8009	32777	Protective door closed (QS = 1).
800B	32779	Two-hand pushbutton operated (QS = 1).
800C	32780	Timing relay output is active (QS = 1).
800D	32781	Waiting for decreasing trigger signal; output active (QS = 1).
800E	32782	Timer running, output is active (QS = 1).
800F	32783	Timer stopped, output is active (QS = 1).
8010	32784	Standstill detected (QS = 1).
8011	32785	Muting state 1.
8012	32786	Muting state 2.
8013	32787	Muting state 3.
8014	32788	Muting state 4.
8015	32789	Muting state 5.
8016	32790	Muting state 6.
8017	32791	Muting state 7.
8018	32792	Muting state Move Clear.

Status number		Plain text
Hexadecimal (0-F)	decimal (0-9)	
801A	32794	Waiting until feedback circuit open.
801B	32795	Check test signal T1 for short circuit.
801C	32796	Check test signal T2 for short circuit.
8024	32804	Muting state 4 in mode 2P
8027	32807	Muting state 7 in mode 2P
802A	32810	Operating mode 1 selected (Q1 = 1).
802B	32811	Operating mode 2 selected (Q2 = 1).
802C	32812	Operating mode 3 selected (Q3 = 1).
802D	32813	Operating mode 4 selected (Q4 = 1).
802E	32814	Operating mode 5 selected (Q5 = 1).
8034	32820	Muting state 4 in mode 2S
8037	32823	Muting state 7 in mode 2S
803A	32826	Operating mode 1 fixed (Q1 = 1).
803B	32827	Operating mode 2 fixed (Q2 = 1).
803C	32828	Operating mode 3 fixed (Q3 = 1).
803D	32829	Operating mode 4 fixed (Q4 = 1).
803E	32830	Operating mode 5 fixed (Q5 = 1).
F001	61441	Error: Discrepancy time expired.
F002	61442	Error: Enable duration exceeded.
F003	61443	Error: Muting duration exceeded.
F004	61444	Error: Synchronization duration exceeded.
F005	61445	Error: Clearing duration exceeded.
F006	61446	Error: Second pushbutton pressed too late (> 500 ms).
F007	61447	Error: Both channels on Low (open circuit).



Status number		Plain text
Hexadecimal (0–F)	decimal (0-9)	
F008	61448	Error: Frequency measuring range exceeded (>1250 Hz).
F009	61449	Error: Different input frequencies.
F00A	61450	Error: No pulses on one channel.
F00B	61451	Error: Reset and inputs operated on function block startup.
F00C	61452	Error: Reset and OC operated on function block startup.
F00E	61454	Error: Only one channel was opened and closed.
F00F	61455	Error: Undefined switch position.
F010	61456	Error: Position 2 not permissible after panic position.
F011	61457	Error: Feedback circuit not opened after time.
F012	61458	Error: Feedback circuit not closed after time.
F013	61459	Error: Reset operated on function block startup.
F014	61460	Error: More than one operating mode selected at the same time.
F015	61461	Error: No operating mode selected.
F016	61462	Error: Short circuit in input channel after 24 V.
F017	61463	Error: Short circuit in input channel after 24 V.
F018	61464	Error: At least one input operated on function block startup.
F019	61465	Error: Implausible processing sequence.
F01A	61466	Error: Muting sequence completed, light curtain not free.
F01B	61467	Error: Clearing completed; light curtain or sensors not free.

### **Diagnostics using the ER contact**

The safety function blocks detect sequence faults such as when the monitored times are not observed. If this type of error is detected, the QS enable contact opens immediately. The fault code is sent to the diagnostics output DG> which can in turn be processed with the DG standard function block, a section "Diagnostics using the DG diagnostics function block", page 616. The error contact ER of the safety function block concerned is closed until the fault is acknowledged by a correct signal sequence at its input coils.

The type of error that causes the error status of the safety function block, and the coils for resetting it again are stated in the description of the individual function blocks, a chapter "Safety function blocks" on page 341.

## Diagnostics of faults inside and outside the device

The easySafety safety control relay monitors itself and also the external wiring.

h

Use the test signal outputs T1 - T4 for optimum monitoring of the external wiring, a chapter "Connecting test signal outputs", page 57.

easySafety is able to detect faults during operation and trigger an appropriate response. easySafety distinguishes between three error classes:

- **Class C**  
If an error does not impair the safety behaviour of easySafety, the device remains in the RUN operating mode. The error is signaled via a diagnostics contact.  
Error example: Error in easyLink protocol or in easyNet.
- **Class B**  
If an error does impair the behaviour of easySafety, but the execution of the device's internal safety test routines is unaffected by this, a safety circuit diagram STOP occurs. The standard circuit diagram continues to be executed. All device outputs are switched off.  
Error example: There is an error present in the device's external wiring, e.g. a short circuit due to faulty insulation in the input circuit.
- **Class A**  
If an error impairs the safety behaviour inside the easySafety, both circuit diagrams are switched to STOP (class A); for example: error in the device. All device outputs are switched off.

The following table provides an overview of the behaviour of the easySafety when an error occurs.

Table 32: Behaviour of easySafety after an error

Error class	Behaviour of the device in the event of a fault			Acknowledgement
	Fault occurs in STOP mode	STOP/ RUN change-over possible?	Fault occurs in RUN mode	
C (minor)	LED FAULT continuously lit green	yes	<ul style="list-style-type: none"> <li>LED FAULT flashes green (0.5 Hz)</li> <li>Safety circuit diagram in RUN</li> <li>Standard circuit diagram in RUN</li> <li>All device outputs are switched.</li> <li>Output via diagnostics contact ID., e.g. ID14 = 1 for an easyLink error.</li> <li>Flashing on the Status display.</li> </ul>	Automatic error acknowledgement after rectification.
B (serious)	<ul style="list-style-type: none"> <li>LED FAULT continuously lit orange</li> <li>Fault indication visible on display</li> <li>Local device outputs are switched off</li> </ul>	no	<ul style="list-style-type: none"> <li>LED FAULT flashes orange (flash frequency 0.5 Hz).</li> <li>Safety circuit diagram stopped</li> <li>Standard circuit diagram in RUN</li> <li>All device outputs are switched off.</li> <li>Output at the diagnostics contact IG (ID10 = 1).</li> <li>Fault indication visible on display</li> </ul>	Error acknowledgement by switching from STOP to RUN. If necessary the power supply must be switched off/on.
A (fatal)	<ul style="list-style-type: none"> <li>LED FAULT continuously lit red</li> <li>Fault indication visible on display</li> <li>Local device outputs are switched off</li> </ul>	no	<ul style="list-style-type: none"> <li>LED FAULT continuously lit red</li> <li>Safety circuit diagram stopped</li> <li>Standard circuit diagram stopped</li> <li>All device outputs are switched off.</li> <li>Fault indication visible on display</li> </ul>	Error acknowledgement is not possible. Device is faulty.

```
EXTERNAL ERROR  
ERROR- TYPE: B  
MODULE I D: 84
```

### Error class B (Error-Type)

If easySafety detects a class B external fault, the red FAULT LED flashes and a message also appears on the display (if present). The message indicates the possible cause of the fault using the module ID. The following table lists some module IDs of class B and a short description of recommended troubleshooting measures.

When in an error condition, you can press the ESC push-button to suppress the error message on the display. You can access the main menu by pressing the OK pushbutton.

h

To learn how to acknowledge errors from all error classes, refer to Table 32 on page 624.

MODULE ID	Possible fault and troubleshooting information	
06	There are deviations between the configuration in the device and on the inserted card: <ul style="list-style-type: none"> <li>• The device stored on the card is not the actual device.</li> <li>• The safety circuit diagram stored on the card is not the same as that in the actual device.</li> </ul> This error cannot occur if the "Allow card overwriting" option has been activated.	
11	There is a short circuit to 24 V DC or GND on a transistor. Check the wiring of the outputs.	
24/25	The 24 V DC power supply of the transistor output is not provided. Feed the transistor outputs with 24 V DC or check the terminal connection for possible incorrect polarity.	
63/101	Short-circuit to 24 V DC. Check the wiring at QS1.	
64/102	Short-circuit to 24 V DC. Check the wiring at QS2.	
65/103	Short-circuit to 24 V DC. Check the wiring at QS3.	
66/104	Short-circuit to 24 V DC. Check the wiring at QS4.	
67/68	The configuration on the device is damaged. Use easySoft-Safety or the memory card to transfer the configuration to the device.	
85 <sup>1)</sup>	Error on test signal cable T1	Possible errors include, for example:
86 <sup>1)</sup>	Error on test signal cable T2	cross-circuits between test signal cables
87 <sup>1)</sup>	Error on test signal cable T3	or a short circuit to 24 VDC, or an error in the assignment to the IS device inputs.
88 <sup>1)</sup>	Error on test signal cable T4	Please check the wiring and routing for test signals T1-T4. Please also check that the T1-T4 test signals are correctly assigned to the device's IS safety inputs.

1) Do not apply any test signals to inputs that have not been assigned a test signal. In this case, easySafety may generate an error message during the power up and prevent the automatic switch to RUN mode. (a chapter "easySafetyoperating modes", page 79)

## Expanding an easySafety device

You can expand an easySafety device using the non-safety easyLink network:

# j

### Danger!

easyLink is a non-safety interface. Safety-related data must not be transferred via this interface.

- Locally with the non-safety expansion modules EASY618-..-RE, EASY620-DC-TE, EASY202-RE.
- Remotely via the non-safety coupling module EASY200-EASY and one of the above mentioned easy600 expansions connected to it.

You can also continue to use easy network modules, such as:

- EASY204-DP for PROFIBUS-DP.
- EASY221-CO for CANopen-Bus.
- EASY205-ASI for the Actuator-Sensor-Interface bus.
- EASY222-DN for DeviceNet.

Install the units and connect the inputs and outputs as described (a section "Connecting the expansion device", page 43).

The expansion device inputs are processed in the standard circuit diagram of a easySafety device as contacts in the same way as the inputs of the basic unit. The input contacts are assigned the operand identifiers R1 to R12.

R15 and R16 are group fault alarms for the expansion devices with transistor outputs (a section "Monitoring the functionality of the expansion device", page 629).

The outputs of the expansion devices are processed as relay coils or contacts like the outputs in the basic unit. The output relays are S1 to S8.

# h

EASY618-..-RE provides the outputs S1 to S6. The other outputs S7, S8 can be used internally.

The operation on the non-safety easyNet is described in a chapter "Introduction to the easyNet network", starting on page 521.

### **How is an expansion device detected?**

If at least one R contact or contact/coil S is used in the circuit diagram, the basic unit assumes that an expansion unit is connected.

### **Transfer behaviour**

The input and output data of the expansion units is transferred serially in both directions.

### **Reaction times of the inputs/outputs of the expansion devices**

The debounce setting has no effect on the expansion unit.

Transfer times for input and output signals:

- Local expansion
  - Time for inputs R1 to R12: 30 ms + 1 cycle.
  - Time for outputs S1 to S6 (S8): 15 ms + 1 cycle.
  
- Remote expansion
  - Time for inputs R1 to R12: 80 ms + 1 cycle.
  - Time for outputs S1 to S6 (S8): 40 ms + 1 cycle.

For an approximate cycle time, you can use the circuit diagram processing time divided in half, a table 30 on page 613.



## Monitoring the functionality of the expansion device

If the power supply of the expansion unit is not present, no connection can be established between it and basic unit. The expansion inputs R1 to R12, R15, R16 are incorrectly processed in the basic unit and show status 0. The outputs S1 to S8 in the expansion device cannot be set.

# j

### Danger!

Ensure the continuous monitoring of easySafety expansion devices in order to prevent switching faults in machines or systems.

The status of the diagnostics contact ID14 of the basic unit indicates the status of the expansion unit:

- ID14 = 0: expansion unit is functional.
- ID14 = 1: expansion unit is not functional.

### Example

The expansion unit may be powered up later than the basic unit. This means that the basic unit is switched to RUN when an expansion unit is missing. The following easySafety circuit diagram detects if the expansion unit is functional or not functional.

```

I D14---- 01----- : 08
----- S M 01
I D14----- : 08
I S01-- - I S02----- QS01
QS01--
...
: 08

```

Figure 297: Standard circuit diagram for expansion testing

As long as ID14 is 1, the remaining standard circuit diagram is skipped. If ID14 is 0, the standard circuit diagram is processed. If the expansion unit drops out for any reason, the standard circuit diagram is skipped again. M01 detects whether the standard circuit diagram was processed for at

least one cycle after the power supply is switched on. If the standard circuit diagram is skipped, all the outputs retain their previous state.

### Checking the transistor output for short-circuit/overload

You can use diagnostics contact R15, R16 to scan whether a short-circuit or overload is present at a transistor output of an EASY620-DC-TE expansion device.

- R16: Group fault alarm for outputs S1 - S4.
- R15: Group fault alarm for outputs S5 - S8.

State	
Fault alarms	R15 or R16
No fault found	0 = switched off (make contact)
At least one output has a fault	1 = switched on (make contact)

## Displaying device information

The device information is provided for service tasks or in order to determine the performance level of the device.

This function is only available with devices featuring a display.

SAFETY. . .  
STANDARD. . .

```
STOP    RUN
SET CLOCK
MODE
I NFORMATI ON. . .
```

X Switch to the main menu and use the cursor button or to move to the INFORMATION menu.

X Press OK.

This will display all device information:

```
Saf et y _Test _APP
22. 12. 2007 17: 07
CRC 9031 V0001
DC TRN
```

```
OS- VER 1. 10. 58
OS- CRC 2177
```

Line 1: shows a program name of max. 16 characters. This can be entered separately for each device under Name in the Information tab in Project View. Line 1 will remain empty if this name is not entered.

Line 2: always shows the date/time of the last change to the safety configuration. Independently of whether the change was made in easySoft-Safety or locally with the easySafety device's operator buttons. In the case of a local change, the version is shown as V0000.

Line 3: Shows the check sum of the configuration in the device as a four digit hexadecimal value with CRC xxxx. Vxxxx shows as four-digit hexadecimal number the version of the configuration created and managed in easySoft-Safety. The display will always show V0000 if you are entering and storing the safety circuit diagram locally via the operator buttons of the easySafety device.

Line 4: shows the result of the hardware detection (power supply, interfaces, I/O type etc).

- DC/AC
  - AC (AC voltage)
  - or DC (DC voltage).
- TRN/R N
  - T: Transistor output,

- or R: Relay output,
- N: easyNet interface available.
  
- X/-
  - Display present/not present. This information can only be displayed by a locally connected MFD-CP4/-CP8 device in Terminal mode. If the remote device is run without a display, the MFD-CP4/-CP8 shows a blank this position.

Line 5: OS-VER e.g. 1.00.60, version of the operating system.

Line 6: OS-CRC e.g. 5825, Checksum of the operating system is only displayed in STOP operating mode.

---

## Device version

Every easySafety has the device version number printed on the left of the device housing. The device version is indicated by the first two digits of the device number.

Example: 01-402110000404

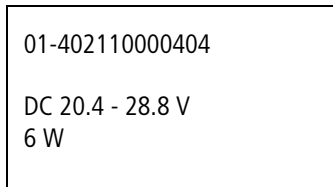

This device is of device version 01.

The device version provides useful service information about the hardware version and the version of the operating system.

## Appendix

<b>List of function blocks</b>			
<b>Element</b>	<b>Meaning of abbreviation</b>	<b>Function block name</b>	<b>Page</b>
A	<b>A</b> nalog value comparator	Analog value comparator	174
AR	<b>A</b> rithmetic	Arithmetic	181
BC	<b>B</b> lock <b>C</b> ompare	Data block comparator	186
BT	<b>B</b> lock <b>T</b> ransfer	Data block transfer	186
BV	<b>B</b> oolean <b>o</b> peration	Boolean sequence	210
C	<b>C</b> ounter	Counter	215
CP	<b>C</b> om <b>P</b> arators	Comparators	223
D	<b>D</b> isplay	Text function block	226
DB	<b>D</b> ata <b>B</b> lock	Data function block	233
DG	<b>D</b> ia <b>G</b> nostic	Diagnostics	237
EM	<b>E</b> xternal device <b>M</b> onitor	Feedback loop monitoring (safety function block)	349
EN	<b>E</b> Nable switch	Enable switch	360
ES	<b>E</b> mergency- <b>S</b> top	Emergency-Stop (safety function block)	371
FS	<b>F</b> oot <b>S</b> witch	Foot switch (safety function block)	382
GT	<b>G</b> ET	GET network	242
HW	<b>H</b> ora <sup>(lat)</sup> <b>W</b> eek	Seven-day time switch	246
HY	<b>H</b> ora <sup>(lat)</sup> <b>Y</b> ear	Year time switch	254
JC	<b>J</b> ump <b>C</b> onditional	Conditional jump	268
LB	<b>L</b> abel	Jump label	272
LC	<b>L</b> ight <b>C</b> urtain	light curtain (safety function block)	394

<b>Element</b>	<b>Meaning of abbreviation</b>	<b>Function block name</b>	<b>Page</b>
LM	<b>L</b> ight curtain <b>M</b> uting	Light curtain muting (safety function block)	408
MR	<b>M</b> aster <b>R</b> eset	Master reset	273
MX	<b>M</b> ultiple <b>X</b> er	Data multiplexer	276
NC	<b>N</b> umeric <b>C</b> oding	Numerical converter	282
OM	<b>O</b> verspeed <b>M</b> onitor	Overspeed monitoring (safety function block)	434
OS	<b>O</b> perating mode <b>S</b> witch	Operating mode switch (safety function block)	449
OT	<b>O</b> perating <b>T</b> ime	Hours-run counter	289
PT	<b>P</b> UT	PUT network	293
SC	<b>S</b> ynchronize <b>C</b> locks	Synchronise clock via network	298
SE	<b>S</b> tart <b>E</b> lement	Start Element (safety function block )	458
SG	<b>S</b> afety <b>G</b> ate	Safety gate with guard locking (safety function block)	465
SR	<b>S</b> hift <b>R</b> egister	Shift register	300
T	<b>T</b> iming relays	Timing relays	315
TB	<b>Ta</b> Bl <b>e</b> function	Table function	330
TH	<b>T</b> wo- <b>H</b> and-button	Two-hand button Type III (safety function block)	481
TS	<b>T</b> ime relay <b>S</b> afety	Time relay Safety (safety function block)	494
ZM	<b>Z</b> ero-speed <b>M</b> onitor	Stand still monitoring (safety function block)	509

### Function block coils

The following table is a general overview of the function block contacts. A detailed overview of all contacts used in the standard and safety circuit diagram is provided in section "Contacts and coils used in the circuit diagram" on page 643.

Table 33: General overview of the function block coils

Coil	Meaning of abbreviation	Description
A	Muting sensor <b>A</b>	Muting Sensor group A
B	Muting sensor <b>B</b>	Muting Sensor group B1
BD	<b>B</b> ackward <b>D</b> irection	Bit data input, backwards shift direction
BP	<b>B</b> ackward <b>P</b> ulse	Trigger coil Clock input, backward shift direction
C_	<b>C</b> ount input	Counter input
D_	<b>D</b> irection input	Count up/down indicator
EN	<b>E</b> nable	Enable function block
FD	<b>F</b> orward <b>D</b> irection	Bit data input, forwards shift direction
FL	<b>F</b> eedback <b>l</b> oop	Signal of the feedback loop
FP	<b>F</b> orward <b>P</b> ulse	Trigger coil Clock input, forward shift direction
I	<b>I</b> nput	Controlled switch
OC	<b>O</b> utput <b>C</b> ontrol	Output signal of the monitored upstream function block
OV	<b>O</b> verride safety function	Override
RE	<b>R</b> Eset	Reset the function block
RF	<b>R</b> ead <b>F</b> irst	Trigger coil On detecting a rising edge (trigger) and EN = 1 the oldest value entered in the table is read out and supplied at output QV (FIFO function)

<b>Coil</b>	<b>Meaning of abbreviation</b>	<b>Description</b>
RL	<b>Read Last</b>	Trigger coil On detecting a rising edge (trigger) and EN = 1 the newest value entered in the table is read out and output at output QV (LIFO function)
SA	<b>Safe Activate</b>	Safe activation of the function block
SE	<b>Set Enable</b>	Set to a predefined value
SM	<b>Set Mode</b>	Acceptance of the new operating mode
ST	<b>STop</b>	Stop block processing
T_	<b>Trigger</b>	Trigger coil for starting the standard timing relay
TR	<b>TRigger</b>	Trigger coil for starting the safety timing relay
UL	<b>UnLock</b>	Ready to accept the new operating mode
WP	<b>Word Pulse</b>	Trigger coil On detecting a rising edge (trigger) and EN = 1 the value is entered in the table



### Function block contacts

The following table is a general overview of the function block contacts. A detailed overview of all contacts used in the standard and safety circuit diagram is provided in section "Contacts and coils used in the circuit diagram" on page 643.

Table 34: General overview of the function block contacts

Contact	Meaning of abbreviation	Description
AC	<b>AC</b> tive	Status 1, as long as the input value has been buffered but not yet transferred to the easyNet with the PUT function block.
CY	<b>C</b> arry	Status 1, if the value range is exceeded; ( <b>carry</b> )
E1	<b>E</b> rror 1	Error 1, dependent on function block
E2	<b>E</b> rror 2	Error 2, dependent on function block
E3	<b>E</b> rror 3	Error 3, dependent on function block
ER	<b>E</b> Rror	Error, dependent on function block
EQ	<b>E</b> Qual	Comparison result, status 1 if values equal.
FB	<b>F</b> all <b>B</b> elow	Status 1, if the actual value is less than or equal to the lower setpoint value;
GT	<b>G</b> reater <b>T</b> han	Status 1 if the value at I1 > I2;
LT	<b>L</b> ess <b>T</b> han	Status 1 if the value at I1 < I2;
OF	<b>O</b> ver <b>F</b> low	Status 1, if the actual value is greater than or equal to the upper setpoint value;
Q	Output ( <b>Q</b> ...)	Standard-switch output
QC	Output ( <b>Q</b> ...) <b>C</b> ommon	Group information of the type of outputs
QM	Output ( <b>Q</b> ) <b>M</b> uting	Muting output
QS	Output ( <b>Q</b> ) <b>S</b> afe	safe switch output

<b>Contact</b>	<b>Meaning of abbreviation</b>	<b>Description</b>
TE	Table <b>E</b> mpy	Status 1 if the table is empty
TF	Table <b>F</b> ull	Status 1 if the table is full
ZE	<b>Z</b> Ero	Status 1, if the value of the element input QV is equal to zero;

## Function block inputs (constants, operands)

Input	Meaning of abbreviation	Description
DT	<b>Discrepancy Time</b>	Discrepancy time
DY1	<b>Day 1</b>	Day 1 of the period
DY2	<b>Day 2</b>	Last day of the period
ED	<b>Enable Duration</b>	Enable time
F1	<b>Factor 1</b>	Gain factor for I1 ( $I1 = F1 \times \text{Value}$ )
F2	<b>Factor 2</b>	Gain factor for I2 ( $I2 = F2 \times \text{Value}$ )
FR	Rotational <b>F</b> requency	Actual value rotation frequency
FT	<b>Feedback Time</b>	Monitoring time of the feedback loop
HY	<b>HY</b> steresis	Switching hysteresis for value I2 (Value HY applies to positive and negative hysteresis.)
I1	<b>Input 1</b>	1st input word
I2	<b>Input 2</b>	2nd input word
KP	<b>Channel</b>	Input channel that is switched through to the output.
MT	<b>M</b> uting <b>T</b> ime	Muting time
NO	<b>N</b> umbers <b>O</b> f elements	Number of elements
ON	<b>ON</b>	Closing delay or on date
OFF	<b>OFF</b>	Off time or date
OS	<b>OffSet</b>	Offset for the value I1
R T	Over <b>R</b> ide <b>T</b> ime	Override release time
SH	<b>S</b> etpoint <b>H</b> igh	Upper limit value
SL	<b>S</b> etpoint <b>L</b> ow	Lower limit value
ST	<b>S</b> ynchronisation <b>T</b> ime	Synchronisation time
SV	<b>S</b> et <b>V</b> alue	Defined actual value (Preset)
T1	<b>Time 1</b>	1. Time value
T2	<b>Time 2</b>	2. Time Value

### Function block output (operands)

Output	Meaning of abbreviation	Description
D1..8	Data Value 1 - 8	Register value 1 - 8
DG	<b>D</b> ia <b>G</b> nostic	Diagnostics
QN	Output Number	Number output, dependent on function block
Q1	Output Time 1	Actual discrepancy time value
Q2	Output Time 2	Actual muting time
Q3	Output Time 3	Synchronisation time actual value
Q4	Output Time 4	Override release time actual value
QV	<b>O</b> utput <b>V</b> alue	Output value

### Other operands

Others	Meaning of abbreviation	Description
MB	<b>M</b> arker <b>b</b> yte	8-Bit value
MW	<b>M</b> arker <b>W</b> ord	16-Bit value
MD	<b>M</b> arker <b>D</b> ouble Word	32-Bit value
NU	<b>N</b> umber	Constant, value range from -2 147 483 648 to +2 147 483 647

## Other function block parameters

Parameters	Meaning of abbreviation	Description
GT	Greater Than	Compare I1 > I2
EQ	Equal	Compare I1 = I2
LT	Less Than	Compare I1 < I2
ADD	Addition	Addition I1 + I2
SUB	Subtraction	Subtraction I1 - I2
MUL	Multiplication	Multiplication I1 x I2
DIV	Division	Division I1 / I2
INI	Initiate	Initialize data storage area
CPY	Copy	Copy data storage area
AND	AND	AND operation
OR	OR	OR operation
XOR	XOR	XOR-Association
NOT	NOT	NOT-Association
BCD	BCD-Value	BCD-to-binary conversion
BIN	Binary-Value	Binary-to-BCD conversion
BIT	Bit	Bit operating mode
DW	Double Word	Operating mode Double word
EN	Enable necessary	Enable required
NEN	No Enable Necessary	Enable not required
MST	Manual Start	Manual start
CST	Controlled Start	Controlled start
AST	Automatic Start	Automatic start
1CH	1 channel	Single-channel Operation

Parameters	Meaning of abbreviation	Description
2 CH	2 channel	Dual-channel Operation
4 CH	4 channel	Four-channel operation
SUT	Start Under Test	With startup test
2 P	2 parallel	Double parallel muting
2 N/ O	2 sequential	Double sequential muting
4 P	4 parallel	Quadruple parallel muting
4 N/ O	4 sequential	Quadruple sequential muting
1 L	1 Locked	Single-channel operation with guard locking
2 L	2 Locked	Dual-channel operation with guard locking
X	-	On-delayed switching
	-	Off-delayed switching
	-	Switching with On-delay and Off-delay
#	-	Off-delayed with random time range, setpoint retriggerable
	-	Single pulse switching
	-	Switching with flashing

**Contacts and coils used in the circuit diagram**

The following table shows a list of all contacts and coils used in the standard circuit diagram. The contacts and coils used in the safety circuit diagram are provided on page 652.

Table 35: Contacts and coils in the standard circuit diagram

Function	Coil contact (* = NET ID 1-8)	Number	Configurable	Page
<b>Inputs</b>				
Safety inputs IS.. of other stations via NET	* I .	01-14	?	552
Inputs (basic device) IS..	I S	01-14	?	—
Cursor button	KP	01-04	?	—
Inputs (standard expansion) of other stations via NET	* R .	01-12	?	548
Inputs (standard expansion device)	R	01-12	?	—
Bit inputs via NET	* RN .	01-32	?	548
<b>Diagnostics inputs</b>				
Diagnostics messages			?	
Malfunction NET station 1 to 8	I D	01-08	?	
Not used		09	?	
Safety circuit diagram stopped due to fault (class B, a page 625).		10	?	
Not used		11	?	
Not used		12	?	
Not used		13	?	
Fault in expansion unit		14	?	

Function	Coil contact (* = NET ID 1-8)	Number	Configurable	Page
Not used		15	?	
Not used		16	?	
Short-circuit/overload with standard expansion	R	15-16	?	615
Short-circuit/overload with standard expansion of other stations via NET	* R *	15-16	?	615

### Outputs

<b>h</b>	The device outputs can only be connected as coils in the standard circuit diagram if these were not already used in the safety circuit diagram. Certain inputs/ outputs of safety function blocks (such as enable inputs or error outputs) can be connected in the safety circuit diagram or also in the standard circuit diagram.			
Outputs (basic device) of other station via NET, can only be written by station with NET ID 1.	* Q	01-08	—	
Outputs QS.. of other station via NET	Q	01-04	?	552
Output, redundant relay	QR	01	?	—
	QR	01		
Output, redundant relay, of other station, via NET	* Q *	07	—	552
Safety outputs (basic device) Relay or transistor	QS	01-04	?	—
	QS			
Outputs (standard expansion)	S	01-08	—	—
	S			



Function	Coil contact (* = NET ID 1-8)	Number	Config- urable	Page
Outputs (standard expansion) of other station via NET	* S * S *	01-08	—	548
Bit outputs via NET	* SN * SN *	01-32	—	548
<b>j</b>	<b>Danger!</b> Device outputs (QS., QR.) used in the standard circuit diagram are not safety outputs, and may only be used for standard tasks. Make sure that these outputs do not trigger any safety-related actions on the machine or plant.			
<b>Other contacts</b>				
Jump label	: :	01-32	—	300
Diagnostics messages	I D	01-16	?-	615
<b>Safety - function blocks</b>				
<b>h</b>	The safety function blocks' EN function block input can only be used in the standard circuit diagram if the enable has been specified as mandatory in the parameter setting. The use of the EN input is either only possible in the safety circuit diagram or in the standard circuit diagram, a section "Enable parameter, EN enable coil", page 345			
Return circuit monitor failure	EM X EN EM X ER X ER	X = 01-14	?-	349
Enable switch failure	EN X EN EN X ER X ER	X = 01-07	?-	360

Function	Coil contact (* = NET ID 1-8)	Number	Configurable	Page
Emergency-Stop failure	ES X EN	X = 01-14	?	371
	ES X ER X ER			
Safety foot switch failure	FS X EN	X = 01-07	?	382
	FS X ER X ER			
Light curtain failure	LC X EN	X = 01-07	?	394
	LC X ER X ER			
Light curtain muting failure	LM X EN	X = 01-02	?	408
	LM X ER X ER			
Maximum speed monitoring failure	OM X EN	X = 01-02	?	434
	OM X ER X ER			
Operating mode selector switch failure	OS X EN	X = 01-07	?	449
	OS X ER X ER			
Start device failure	SE X EN	X = 01-16	?	458
	SE X ER X ER			
Protective door failure	SG X EN	X = 01-14	?	465
	SG X ER X ER			
Two-hand button failure	TH X EN	X = 01-07	?	481
	TH X ER X ER			
Safety timing relay failure	TS X ER	X = 01-16		494
	X ER			
Zero speed monitoring Fault	ZM X EN	X = 01	?	509
	ZM X ER X ER			

Function	Coil contact (* = NET ID 1-8)	Number	Configurable	Page
<b>Standard function blocks</b>				
Analog value comparator			j	174
Value overflow (carry)	A X CY X CY	X = 01-16		
Condition fulfilled	A X Q1 X Q1			
Arithmetic			j	181
Value overflow (carry)	AR X CY X CY	X = 01-16		
Value zero	AR X ZE X ZE			
Data block comparator			j	186
Enable	BC X EN	X = 01-16		
Failure: number of elements exceeded	BC X E1 X E1			
Failure: range overlap	BC X E2 X E2			
Failure: invalid offset	BC X E3 X E3			
Comparison result	BC X EQ X EQ			
Data block transfer			j	196
Trigger coil	BT X T_	X = 01-16		
Failure: number of elements exceeded	BT X E1 X E1			
Failure: range overlap	BT X E2 X E2			
Failure: invalid offset	BT X E3 X E3			
Boolean sequence			j	210
Value zero	BV X ZE X ZE	X = 01-16		

Function	Coil contact (* = NET ID 1-8)	Number	Configurable	Page
Counter			j	215
Count input	C X C_	X = 01-16		
Direction	C X D_			
Reset count value	C X RE			
Set counter value (preset)	C X SE			
Actual value has exceeded counter range (carry)	C X CY X CY			
Lower setpoint value under-shot (Fall below)	C X FB X FB			
Upper setpoint value exceeded (overflow)	C X OF X OF			
Actual value equal to zero	C X ZE X ZE			
Comparison, for variables / constants	CP	X = 01-16	j	223
Equal to	CP X EQ X EQ			
Greater than	CP X GT X GT			
Less than	CP X LT X LT			
Text output			j	226
Enable	D X EN	X = 01-16		
active	D X Q1 X Q1			
Data function block			j	233
Transfer 32-bit value Trigger coil	DB X T_	X = 01-16		
Block is active	DB X Q1 X Q1			

Function	Coil contact (* = NET ID 1-8)	Number	Configurable	Page
Diagnostics			j	237
Enable	DG X EN	X = 01-16		
Failure 1 to 8	DG X Q1 . . 8 X Q1 . . 8			
Group message	DG X QC X QC			
Get value from NET (GET)			j	242
New transferred value present	GT X Q1 X Q1	X = 01-16		
Week time switch			j	246
Switch on condition fulfilled	HW X Q1 X Q1	X = 01-16		
Year time switch			j	254
Switch on condition fulfilled	HY X Q1 X Q1	X = 01-16		
Conditional jump			—	268
Enable	JC X EN	X = 01-16		
Fault: No corresponding jump label present or backward jump	JC X E1 X E1			
Jump Label (Label)	x:	X = 01-32	?	272
Passive jump destination for JC	x:			
Master reset			j	273
Trigger coil	MR X T_	X = 01-16		
Set all outputs and markers to zero state	MR X Q1 X Q1			
Data multiplexer			j	276
Enable	MX X EN	X = 01-16		
Fault: Incorrect parameter setting, $0 > K > 7$	MX X E1 X E1			

Function	Coil contact (* = NET ID 1-8)	Number	Configurable	Page
Numerical converter			j	282
Enable	NC X EN	X = 01-16		
Hours-run counter			j	289
Enable	OT X EN	X = 01-04		
Reset	OT X RE			
Set time reached	OT X Q1 X Q1			
Put value on NET (PUT)			j	293
Trigger	PT X T_	X = 01-16		
Enable active	PT X Q1 X Q1			
Operand in send buffer	PT X Q1 X Q1			
Error: operand not sent	PT X E1 X E1			
Synchronize clock via NET (Set clock)			—	298
Trigger	SC X T_	X = 01		
Trigger acknowledgement	SC X Q1 X Q1			
Shift register			j	300
Enable	SR X EN	X = 01-16		
Pulse input forward	SR x FP			
Pulse input, reverse	SR x BP			
Reset	SR x RE			
Data input forward	SR x FD			
Data input backward	SR x BD			
Shift register	SR X Q1-8 X Q1-8			

Function	Coil contact (* = NET ID 1-8)	Number	Config- urable	Page
Timing relays			j	315
Trigger control coil (enable)	T X EN	X = 01-16		
Timing relay reset	T X RE			
Timing relay Stop	T X ST			
Timer relay	T X Q1 X Q1			
Table function			j	330
Enable	TB X EN	X = 01-16		
Trigger: Enter input	TB x WP			
Trigger: output oldest value	TB x RF			
Trigger: output most recent value	TB x RL			
Trigger: delete table	TB x RE			
Table empty	TB X TE X TE			
Table full	TB X TF X TF			

Table 36: Contacts and coils in the safety circuit diagram

Function	Coil Contact	Number	Configurable	Page
<b>Inputs</b>				
Incoming terminals	I S	X = 01-14	?	–
<b>Outputs</b>				
Safety output				
Redundant relay	QR	X1	j	–
	QR			
Relay or transistor outputs	QS	1- 4	j	–
	QS			
<b>Others</b>				
Safety marker	MS	X = 01-32	j	
	MS			
<b>Safety - function blocks</b>				
<b>h</b>	EN can be used either in the safety circuit diagram or in the standard circuit diagram. The ER function block contact can be used both in the safety circuit diagram and in the standard circuit diagram.			
Return circuit monitor			j	349
Enable	EM X EN	X = 01-14		
Feedback circuit	EM X FL			
Safety activation	EM X OC			
Reset	EM X RE			
Enable	EM X QS X QS			



Function	Coil Contact	Number	Config- urable	Page
Faults	EM X ER X ER			
Enable switch			j	360
Enable	EN X EN	X = 01-07		
Channels 1 to 2	EN X I 1-1 2			
Safety activation	EN X SA			
Enable	EN X QS X QS			
Faults	EN X ER X ER			
Emergency-Stop			j	371
Enable	ES X EN	X = 01-07		
Channels 1 and 2	ES X I 1-1 2			
Reset	ES X RE			
Enable	ES X QS X QS			
Faults	ES X ER X ER			
Safety foot switch			j	382
Enable	FS X EN	X = 01-07		
Channels 1 to 4	FS X I 1-1 4			
Safety activation	FS X SA			
Enable	FS X QS X QS			
Faults	FS X ER X ER			

Function	Coil Contact	Number	Configurable	Page
Light curtain			j	394
Enable	LC X EN	X = 01-07		
Channels 1 and 2	LC X I 1-1 2			
Reset	LC X RE			
Enable	LC X QS X QS			
Faults	LC X ER X ER			
Light curtain muting			j	408
Enable	LM X EN	X = 01-02		
Channels 1 and 2	LM X I 1-1 2			
Muting sensors Group A	LM X A1 - A2			
Muting sensors Group B	LM X B1 - B2			
Override	LM X OV			
Reset	LM X RE			
Muting	LM X QM X QM			
Enable	LM X QS X QS			
Faults	LM X ER X ER			
High rev monitor			j	434
Enable	OM X EN	X = 01-02		
Reset	OM X RE			
Safety activation	OM X SA			
Enable	OM X QS X QS			
Faults	OM X ER X ER			

Function	Coil Contact	Number	Config- urable	Page
Operating mode selector switch			j	449
Enable	OS X EN	X = 01-07		
Channels 1 to 5	OS X I 1-1 5			
Enable for operating mode change	OS X UL			
Assuming an operating mode	OS X SM			
Operating mode 1 to 5	OS X Q1-Q5 X Q1-Q5			
Faults	OS X ER X ER			
Start device			j	458
Enable	SE X EN	X = 01-16		
Channel 1	SE X I 1			
Reset	SE X RE			
Enable	SE X QS X QS			
Protective door			j	465
Enable	SG X EN	X = 01-14		
Channels 1 through 2 (gate switch)	SG X I 1-1 2			
Channel 3 (guard locking)	SG X I 3			
Reset	SG X RE			
Enable	SG X QS X QS			
Faults	SG X ER X ER			

Function	Coil Contact	Number	Configurable	Page
Two-hand button			j	481
Enable	TH X EN	X = 01-07		
Channels 1 to 4	TH X I 1-4			
Enable	TH X QS X QS			
Faults	TH X ER X ER			
Safety timing relay			j	494
Safety activation	TS X SA	X = 01-16		
Safe start (trigger)	TS X TR			
Safety stop	TS X ST			
Enable	TS X QS X QS			
Faults	TS X ER X ER			
Stand still monitoring			j	509
Enable	ZM X EN	X = 01		
Reset	ZM X RE			
Safety activation	ZM X SA			
Enable	ZM X QS X QS			
Faults	ZM X ER X ER			

**Memory requirement**

The following table serves as an overview of the memory requirement of the easySafety for rungs, function blocks and their associated constants.

h

Avoid empty rungs dispersed between written rungs after operands have been deleted. These kinds of empty rungs take up just as much space as a written rung.

	Space requirement per rung/function block	Space requirement per constant at function block input
	Byte	Byte
<b>Rung</b>	20	-
:	-	-
<b>Function blocks</b>		
A	68	4
AR	40	4
BC	48	4
BT	48	4
BV	40	4
C	52	4
CP	32	4
D	160	-
DB	36	4
DG	136	4
EM	28	-
EN	32	-
ES	28	-
FS	32	-
GT	28	-
HW	68	4 (per channel)

	Space requirement per rung/function block	Space requirement per constant at function block input
	Byte	Byte
HY	68	4 (per channel)
JC	20	-
LB	-	-
LC	28	-
LM	56	-
MR	20	-
MX	96	4
NC	32	4
OM	36	-
OS	24	-
OT	36	4
PT	36	4
SC	20	-
SE	20	-
SG	28	-
SR	96	4
T	48	8
TB	112	4
TH	24	-
TS	40	-
ZM	36	-

Technical data		General
		<b>ES4P...</b>
<b>General</b>		
Standards		EN ISO 13849-1 EN 50156-1 EN 50178 EN 50581 EN 61000-6-2 EN 61000-6-3 IEC 61508 IEC 62061
Dimensions (W x H x D)	mm	107.5 (6 space units) x 90 x 72
	inch	4.23 x 3.54 x 2.84
Weight	kg	0,35 (ES4P-22.-DM..) 0.38 (ES4P-22.-DR..)
	lb	0,77 (ES4P-22.-DM..) 0.84 (ES4P-22.-DR..)
Mounting		Top-hat rail IEC/EN 60715, 35 mm or screw fixing usingfixing brackets ZB4-101-GF1 (accessories).

		ES4P...
<b>safety-relevant characteristic value</b>		
Category	EN ISO 13849-1	Cat. 4
PL		to e
SILCL according to	IEC 62061	Up to 3
SIL according to	IEC 61508	Up to 3
Proof Test		20 Years
<b>2-channel architecture/HFT 1</b>		
EN ISO 13849-1		
MTTF <sub>d</sub>	Years	<b>Relay output</b> 1 $K1 + K2 \times c$ $K1 = 1.7 \times 10^{-3}$ $K2 = 1.2 \times 10^{-3}$ $c = \text{operating frequency}$
		<b>Transistor output</b> 315
T10 <sub>d</sub>	Years	10 % von MTTF <sub>d</sub>
IEC 62061		
PFH <sub>D</sub>	1/h	<b>Relay output</b> $K1 + K2 \times c^2 + K3 \times c$ $K1 = 6.4 \times 10^{-10}$ $K2 = 2.6 \times 10^{-11}$ $K3 = 3.2 \times 10^{-10}$ $c = \text{operating frequency}$
		<b>Transistor output</b> $6,57 \times 10^{-10}$



			ES4P...
IEC 61508			
PFD			<b>Relay output</b> $K1 + K2 \times c^2 + K3 \times c$  $K1 = 5.1 \times 10^{-5}$ $K2 = 1.5 \times 10^{-6}$ $K3 = 2.4 \times 10^{-5}$ $c = \text{operating frequency}$
			<b>Transistor output</b> $5.29 \times 10^{-5}$
PFH		1/h	<b>Relay output</b> $K1 + K2 \times c^2 + K3 \times c$  $K1 = 6.4 \times 10^{-10}$ $K2 = 2.6 \times 10^{-11}$ $K3 = 3.2 \times 10^{-10}$ $c = \text{operating frequency}$
			<b>Transistor output</b> $6.57 \times 10^{-10}$
<b>1-channel architecture/HFT 0</b>			
EN ISO 13849-1			
MTTF <sub>d</sub>		Years	<b>Relay output</b>  $1$ $K1 + K2 \times c$  $K1 = 1.7 \times 10^{-3}$ $K2 = 1.2 \times 10^{-3}$ $c = \text{operating frequency}$
			<b>Transistor output</b> 315
T10 <sub>d</sub>		Years	10 % von MTTF <sub>d</sub>

			ES4P...
IEC 62061			
PFH <sub>D</sub>			<b>Relay output</b> $K1 + K2 \times c$  $K1 = 1.3 \times 10^{-9}$ $K2 = 1.3 \times 10^{-8}$ $c = \text{operating frequency}$
			<b>Transistor output</b> $2.52 \times 10^{-9}$
IEC 61508			
PFD			<b>Relay output</b> $K1 + K2 \times c$  $K1 = 1,1 \times 10^{-4}$ $K2 = 1,1 \times 10^{-3}$ $c = \text{operating frequency}$
			<b>Transistor output</b> $2.06 \times 10^{-4}$
PFH		1/h	<b>Relay output</b> $K1 + K2 \times c$  $K1 = 1.3 \times 10^{-9}$ $K2 = 1.3 \times 10^{-8}$ $c = \text{operating frequency}$
			<b>Transistor output</b> $2.52 \times 10^{-9}$

			ES4P...
<b>Times</b>			
Inputs			
Max. duration of external test pulse		ms	1
Semiconductor output (transistor)			
Off test pulse		ms	< 1
Off-delay		ms	< 1
Relay output			
Off-delay		ms	<50
Response time	a page 612		
<b>Terminal capacity</b>			
solid		mm <sup>2</sup>	0.2 – 4 (AWG 22 – 12)
flexible with ferrule		mm <sup>2</sup>	0,2 – 2,5 (AWG 22 – 12)
standard screwdriver		mm	3.5 x 0.8
standard screwdriver		inch	0.14 x 0.03
Max. tightening torque		Nm	0.6

ES4P...

**Ambient climatic conditions**

Cold to IEC 60068-2-1, heat to IEC 60068-2-2, damp heat, constant, to IEC 60068-2-78; Damp heat, cyclical to IEC 60068-2-30)

Operating ambient temperature	°C, (°F)	–25 to +55, (–13 to +131)
Condensation		Prevent condensation with suitable measures
LCD display (reliably legible)	°C, (°F)	0 to +55, (–+32 to +131)
Storage	°C, (°F)	–40 to +70, (–40 to +158)
Relative humidity, non-condensing (IEC 60068-2-30)	%	5 to 95
Air pressure (in operation)	hPa	795 to 1080

**Ambient mechanical conditions**

Degree of protection EN 50178, IEC 60529, VBG4			IP20
Oscillations (IEC 60068-2-6)			
Constant amplitude 0.15 mm		Hz	10 to 57
Constant acceleration 2 g		Hz	57 to 150
Mechanical shock resistance (IEC 60068-2-27) semi-sinusoidal 15 g/11 ms	Shocks		18
Drop (IEC 60068-2-31)	Drop height	mm	50
Free fall, packaged (EN 61131-2)		m	0.3

ES4P...

**Electromagnetic compatibility (EMC) according to IEC 61000-4, IEC 61000-6-2**

Electrostatic discharge (ESD), to IEC 61000-4-2			
Air discharge	kV		8
Contact discharge	kV		6
Electromagnetic fields (RFI), to IEC 61000-4-3	V/m		20
Radio interference suppression	EN 55011		Class B,
Burst, to IEC 61000-4-4			
Power lines	kV		4
Signal lines	kV		4
Power pulses (surge), to IEC 61000-4-5	kV		1 (supply cables inputs, symmetrical) 2 (semi-conductor outputs, symmetrical)
radiated RFI, to IEC 61000-4-6	V		20

**Increased EMV requirements to IEC 62061 for safety-related functions.**

Electrostatic discharge (ESD), to IEC 61000-4-2			
Air discharge	kV		15
Contact discharge	kV		8
Electromagnetic fields (RFI), to IEC 61000-4-3	V/m		30
Burst, to IEC 61000-4-4			
Power lines	kV		4
Signal lines	kV		4
Power pulses (surge), to IEC 62061	kV		2 (supply cables inputs, symmetrical) 4 (semi-conductor outputs, symmetrical)

		ES4P...
radiated RFI, to IEC 61000-4-6	V	20
Conducted Common mode voltage	IEC 61000-4-16	1,5 kHz to 15 kHz 1 to 10 V, 20 dB/Dec
		15 kHz to 150 kHz, 10 V
		DC, 16 ⅔ Hz, 10 V 50/60 Hz 10 V continuous 100 V short duration (1s)
		150/180 Hz, 10 V continuous
voltage dips	IEC 61000-4-29	40% $U_T$ , 10 ms
short interruptions	IEC 61000-4-29	0% $U_T$ , 20 ms

**Insulation resistance**

Overvoltage category/ degree of pollution		III/2
Clearance in air and creepage distances		EN 50178, UL 508, CSA C22.2, No. 142, EN 60664-1
Insulation resistance		EN 50178

**Back-up/accuracy of the real-time clock**

Back-up time

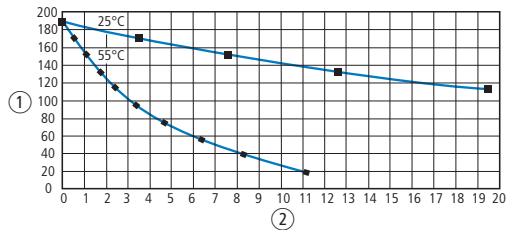

① Back-up time (hours)

② Service life (years)

Accuracy of the real-time  
clock

s/day

Normally  $\pm 2$  ( $\pm 0.5$  h/year)  
The accuracy of the real-time clock can vary, depending on the average ambient temperature, up to  $\pm 5$  s/Day.

		ES4P...
<b>Repetition accuracy of timing relays in the standard circuit diagram/safety circuit diagram</b>		
Accuracy of timing relay (from value)	%	g 0,02
Resolution		
Range "S"	ms	50
Range "M:S"	s	1
Range "H:M"	min	1
<b>Retentive memory</b>		
Read/Write cycles of the retentive memory (minimum)	to 2011	$10^{10}$ (10000000000)
	from 2012	$10^{14}$ (100000000000000)

**Voltage supply:DC**

			ES4P...
Rated operational voltage	$U_e$	V	24 DC (-15/+20%)
permissible range		V DC	20.4 to 28.8
Residual ripple		%	F 5
Input current			
At rated voltage		mA	<250
Voltage dips, IEC 61131-2		ms	10
Power loss		W	<6
Fuse		A	f 1 to F 4



### Network easyNet

		ES4P-2...
easyNet (CAN based)		
Control operating mode easyNet		
Number of users		max. 8
Data transfer rate/ distance		1000 kBit/s, 6 m 500 kBit/s, 25 m 250 kBit/s, 40 m 125 kBit/s, 125 m 50 kBit/s, 300 m 20 kBit/s, 700 m 10 kBit/s, 1000 m
a	The following applies to data transfer rate/distance in the easyNET network: Bus lengths greater than 40 m can only be achieved with enhanced cross-section conductors and terminal adapters, a section "Cable length with cross-sections" on page 66.	
Potential isolation		
From power supply		yes
From the inputs		yes
to the outputs		yes
From the PC interface, memory card, NET network, EASY-Link		yes
Bus termination (first and last station)		yes
Connection type		RJ45, 8-polig

### Digital inputs 24 V DC

			ES4P...
Number			14
Status indication			LCD display (if provided)
Potential isolation			
To power supply			No
Between each other			no
to the outputs			yes
to PC interface, memory card, easyLink			No
to network easyNet			yes
Rated operational voltage	$U_e$	V DC	24
At signal "0"	$U_e$	V DC	< 5
At signal "1"	$U_e$	V DC	> 15.0
Input current at signal "1"			
IS1 to IS14		mA	5.7 (at 24 V DC)
Hardware delay time from 0 to 1			
Debounce ON		ms	24
Debounce OFF		ms	0.06 (IS1, IS2) 0.17 (IS3 to IS14)
Hardware delay time from 1 to 0			
Debounce ON		ms	24
Debounce OFF		ms	0.08 (IS1, IS2) 0.22 (IS3 to IS14)
Cable length (unscreened)		m	100
Single cable length of test signal output to the device input (shielded)		m	1000

		ES4P...
Total of single cable lengths from one test signal output to the device inputs (shielded)	m	3000
Maximum rotational frequency at device inputs IS1 and IS2 when using function blocks OM or ZM.	Hz	1000
Maximum switching frequency at input (applies for I1 and I2 only if one of the function blocks OM or ZM is used)	Operation s/h	900

### Test signal outputs

		ES4P...
Number		4 (T1 to T4)
Voltage	V DC	24
Electrical isolation		no
Cable length		see "digital inputs (24 V DC)"

## Relay outputs

# h

### Caution!

Test the relay outputs at least once in 6 months.

			ES4P-...-DR..., ES4P-...-DM...
Quantity			4 for ES4P-...-DR.. 1 redundant for ES4P-...-DM...
Outputs in groups of			1
Parallel switching of outputs to increase performance			Not permissible
Safety level in accordance with EN 50156			3 redundant relay outputs, 6 months test interval
Protection of an output relay			Fuse: 6 A gL/gG, Circuit-breaker with characteristic C: 24 V DC 4 A, Short-circuit current IK < 250 A
Potential isolation			
To power supply			yes
From the inputs			yes
From the PC interface, memory card, NET network, EASY-Link			yes
Safe isolation according to EN 50178	V AC		300
Basic insulation	V AC		600
Lifespan, mechanical	Switch operations	x 10 <sup>6</sup>	10
Contacts			
Conventional thermal current		A	6
Rated impulse withstand voltage $U_i(t)_{mp}$ contact coil		kV	6
Rated operational voltage	$U_e$	V AC	250

			ES4P-...-DR..., ES4P-...-DM...
Rated insulation voltage	$U_{imp}$	V AC	250
Safe isolation to EN 50178 between coil and contact		V AC	300
Switching capacity, to IEC 60947-5-1			
AC-15, 230 V AC, 3 A	Switch opera- tions		80000
DC-13, 24 V DC, 5 A, 0,1 Hz	Switch opera- tions		40000
Switching frequency			
Mechanical operations		x $10^6$	10
Switching frequency		Hz	15
UL/CSA			
UL 508			B300/R300

### Transistor outputs

			ES4P-...-DT..., ES4P-...-DM...
Number			4
Rated operational voltage	$U_e$	V DC	24
permissible range	$U_e$	V DC	20.4 – 28.8
Residual ripple		%	F 5
Supply current			
at signal "0"	Normal-ly/max.	mA	30/50
at signal "1"	Normal-ly/max.	mA	60/100
Reverse polarity protection			yes
Potential isolation			
To power supply			yes
From the inputs			yes
From the PC interface, memory card, NET network, EASY-Link			yes
Rated operational current at signal "1"	$I_e$	A	
Lamp load without $R_V$		W	5
Output voltage			
With condition "0" at external load < 10 MO		V	F 2.4
with condition "1" at $I_e = 0.5$ A		V	$U = U_e - 1$ V
Short-circuit protection			yes
Short-circuit tripping current for $R_a$ F 10 mO		A	0.7 F $I_e$ F 2 per output
Total short-circuit current		A	8
Peak short-circuit current		A	16

			ES4P-...-DT..., ES4P-...-DM...
Thermal cutout			yes
Back-up fuse		A	F 8
max. load capacity		μF	0.6
max. Cable length (unscreened)		m	50
Max. operating frequency at constant resistive load $R_L < 100 \text{ k}\Omega$ (dependent on program and load)		Operation s/h	13500
Parallel connection of outputs			no
Status display of the outputs			LCD display (if provided)
Inductive load (to EN 60947-5-1: 2004)			
DC-13, $T_{0.95} = 72 \text{ ms}$ , $R = 48 \text{ }\Omega$ , $L = 1.15 \text{ H}$			
DC-14, $T_{0.95} = 15 \text{ ms}$ , $R = 48 \text{ }\Omega$ , $L = 0.24 \text{ H}$			
Utilization factor		g	1
Relative duty factor		% DF	100
Max. switching frequency, max. duty factor = 50%)	f	Hz	0.5

- a For inductive load, without external suppressor circuit, of transistor output is valid:  $T_{0.95}$  = time in ms, until 95 % the stationary current is reached.  $T_{0.95} \geq 3 \times T_{0.65} = 3 \times L/R$ .

## Dimensions

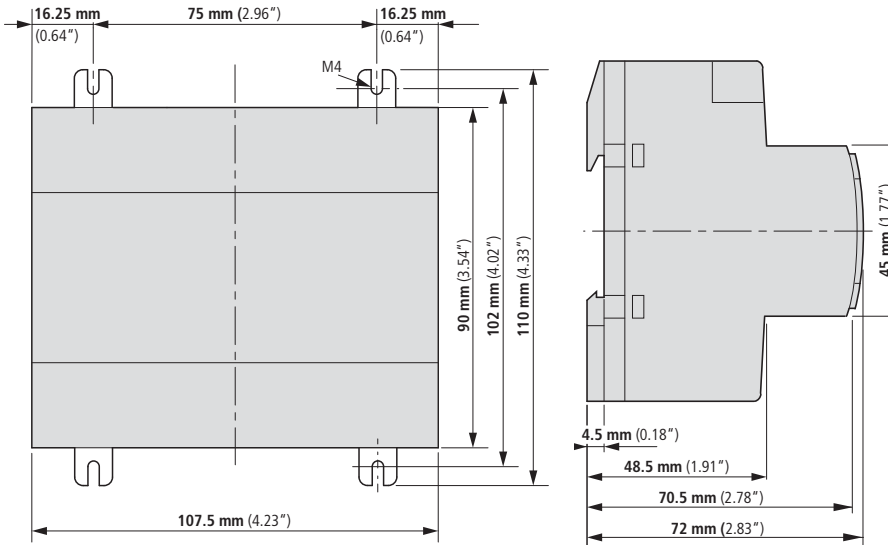

Figure 298: easySafety dimensions in mm (Stated in inches a table 37)

Table 37: Dimensions in inches

mm	inches	mm	inches
4.5	0.177	75	2.95
16.25	0.64	90	3.54
48.5	1.91	102	4.01
70.5	2.78	107.5	4.23
72	2.83	110	4.33



# Index

---

<b>A</b>	A, analog value comparator/threshold value switch (standard FB) .....	174
	Access authorisation .....	568
	Access levels .....	569
	Add .....	181
	Adding	
	Rung .....	89, 139
	Switch contact .....	88, 96, 99
	Addressing examples .....	65
	ALT button .....	110
	Analog value comparator (standard FB) .....	174
	AR, arithmetic function block (standard FB) .....	181
	Arithmetic function block, AR (standard FB) .....	181
	Assigning	
	the diagnostics and safety function block with easySoft-Safety .....	616
	Auxiliary relays -> Markers	

---

<b>B</b>	Backward jumps .....	151
	Basic arithmetic functions .....	181
	BC, data block comparator (standard FB) .....	186
	Break contact .....	114
	Inverting .....	136
	BT, data block transfer (standard FB) .....	196
	Bus connection plug .....	61
	Bus termination resistor .....	62
	Buttons, for editing circuit diagrams and function blocks .....	109

<b>C</b>	<b>C</b> .....	215
	Cable	
	Cross-section .....	66
	Length .....	66
	Point-to-point communication .....	70
	Programming .....	69
	Protection .....	44
	Resistance .....	66
	Cable layout, network cable .....	61
	Cables	
	Network connection .....	60
	Cancel, circuit diagram entry .....	140
	card -> memory card	
	Change	
	Password .....	577
	Changing	
	Coils and contacts .....	132
	Connections .....	137
	Contact, Switch duration and time .....	315
	Function block parameters .....	166
	Menu language .....	583
	NET configuration .....	540
	Value (operating method) .....	24
	Changing input values, on function blocks .....	168
	Circuit diagram	
	Check .....	143
	Creating, example .....	81
	Delete .....	107
	Display .....	85
	Elements .....	111
	Internal evaluation .....	604
	Saving .....	139
	Testing .....	104
	Circuit diagram processing time, maximum .....	613
	Coil	
	Deleting .....	136
	Entry, changing .....	133
	Searching .....	140
	Coil field .....	120

Coil function	
Overview .....	145
Coil negation .....	148
Coils	
Connecting .....	137
Definition .....	114
Comparator, CP (standard FB) .....	223
Compare	
Analog/threshold values .....	174
Marker ranges .....	186
Comparing, Variables/constants .....	223
Conditional jump, JC (standard FB) .....	268
Connect PC .....	69
Connecting	
Contactors, relays, motors .....	50
easyNet network .....	59
Expansion .....	43
Inputs .....	46
Local expansion .....	74
Multi-function interface .....	68
Outputs .....	49
PC .....	69
Point-to-point communication .....	70
Power supply .....	44
Pushbuttons, (proximity) switches .....	47
Relay outputs .....	51
Remote expansion .....	75
Test signal outputs .....	57
Transistor outputs .....	53
Connecting easyNet network .....	59
Connecting remote expansion .....	75
Connecting the expansion device .....	43
Connecting the multi-function interface .....	68
Connecting the power supply .....	44
Connecting the serial interface .....	68
Connecting transistor outputs .....	53
Connecting.(ALT button) .....	110
Connection	
Deleting .....	138
Representation in circuit diagram display ...	121

Constants	
Alphabetical list .....	639
Assigning, FB input .....	164
Contact .....	120
Bounce .....	589
Bounce suppression .....	609
Changing, make contact break contact .....	136
Changing, Switch duration and time .....	315
Connecting .....	137
Cursor buttons .....	142
Definition	
Deleting .....	136
Entry, changing .....	132
Searching .....	140
Contactor function .....	146
Copying	
Data .....	196
Marker ranges (CPY) .....	205
counter relays C (standard FB) .....	215
Counter relays, C (standard FB) .....	215
CP, comparator (standard FB) .....	223
Cursor buttons, function .....	110
Cursor display .....	37
Cycle pulse	
Falling edge .....	149
Rising edge .....	148
<b>D</b>	
D, text display (standard FB) .....	226
Data block comparator, BC (standard FB) .....	186
Data block transfer, BT (standard FB) .....	196
Data function block, DB (standard FB) .....	233
Data multiplexer, MX (standard FB) .....	276
Date display .....	27
Date setting .....	584
Daylight Saving Time .....	585
Daylight saving time .....	585
DB, data function block (standard FB) .....	233
DEBOUNCE .....	589, 609
Default setting .....	578
Delay times .....	610

Delete	
All .....	36
Password .....	577
DELETE ALL .....	36
DELETE FUNCTION .....	573
Deleting	
Circuit diagram on card .....	128
Function blocks .....	170
Operands on FB inputs/outputs .....	165
Retentive actual values .....	600
Retentive area .....	599
Rung .....	139
Deleting retentive actual values .....	600
Detecting cross-circuits (test signals) .....	153
Device	
Brackets .....	42
Overview .....	21
Device Version .....	632
DG, Diagnostics (standard FB) .....	237
Diagnostic codes .....	353
Diagnostics	
-Error codes .....	618
of faults inside and outside the device .....	623
-Register .....	617
Status display .....	26
using the DG diagnostics function block .....	616
using the ER contact .....	622
using the ID diagnostics contact .....	615
Divide .....	181
<hr/>	
<b>E</b>	Electrical isolation, between basic unit and expansion device .....
	74
	EM, external device monitoring (safety FB) .....
	349
	Emergency circuit .....
	95
	Emergency-stop, ES (safety FB) .....
	371
	EN, enable switch (safety FB) .....
	360
	Enable switch, EN (safety FB) .....
	360
	ER contact .....
	622

Error	
Behaviour of easySafety .....	624
Classes .....	624
Codes .....	618
Error -> see also diagnostics	
ES, Emergency-stop (safety FB) .....	371
ESC button .....	110
Evaluating a falling edge .....	149
Evaluating a rising edge .....	148
Evaluating status message, from status FB .....	237
Expanding inputs/outputs .....	73
Expansion units .....	73

---

<b>F</b>	F2 cable protection .....	56
	Failure codes .....	353
	Fault -> Diagnostics	
	Fields .....	120
	FS, safety foot switch (safety FB) .....	382
	Function block -> Function blocks	
	Function block editor .....	159, 162
	Function block list .....	162
	Resorting .....	605
	Function blocks	
	Adding to the circuit diagram for the first time .	157
	Alphabetical list .....	633
	Assigning operands .....	164, 165
	Changing parameters .....	166
	Checking .....	171
	Coils, alphabetical list .....	635
	Contacts, alphabetical list .....	637
	Definition .....	113
	Deleting .....	170
	Editor for parameter setting .....	159, 162
	General notes .....	155
	Inputs, alphabetical list	
	List .....	162
	Memory requirement .....	657
	Parameter dialog .....	159
	Parameter setting .....	158

	Function overview .....	18
	Furnaces .....	50
<hr/>		
<b>G</b>	GO TO other rungs .....	141
	GT, Get value from network (standard FB) .....	242
<hr/>		
<b>H</b>	Hardware Fault Tolerance	
	HFT 0 .....	661
	HFT 1 .....	660
	HW, 7-day time switch (standard FB) .....	246
	HY, year time switch (standard FB) .....	254
<hr/>		
<b>I</b>	Impulse relay .....	146
	Initialising	
	Data .....	196
	Marker ranges .....	200
	Input current .....	47
	Input delay .....	609
	Setting .....	589
	Inputs	
	Connecting .....	46
	Expanding .....	73
	Status display .....	26
	Installation, device .....	39
	INTERFACE .....	573
	Invert	
	Menu items for safety functions .....	31
	Inverting	
	Contact .....	136
	Contactor function .....	148
<hr/>		
<b>J</b>	JC, conditional jump (standard FB) .....	268
	Jump label, LB (standard FB) .....	272
	Jumps .....	150

<b>K</b>	Key to part numbers .....	23
	Keyboard .....	24
<hr/>		
<b>L</b>	Lamp controller .....	86
	Language selection, menu texts .....	583
	Latching relay .....	147
	LB, jump label (standard FB) .....	272
	LC, Light curtain (safety FB) .....	394
	LED display .....	22
	Light curtain muting, LM (safety FB) .....	408
	Light curtain, LC (safety FB) .....	394
	LM, Light curtain muting (safety FB) .....	408
	Local expansion	
	Connecting .....	74
<hr/>		
<b>M</b>	Main menu	
	Change to .....	31
	Overview .....	32
	Make contact .....	114
	Inverting .....	136
	Marker ranges	
	Copying .....	205
	Initialising .....	200
	Markers	
	Assigning, FB input .....	164
	Definition .....	115
	Reset .....	273
	Retention .....	118
	Value range .....	119
	Master password .....	569
	Master reset, MR (standard FB) .....	273
	Memory card .....	122
	Fitting .....	72
	Memory display, circuit diagram .....	121
	Memory requirement, for rungs and function blocks	
	657	



Menu language	
Changing .....	583
Initial switch on .....	78
Menu structure .....	30
Message	
PROG INVALID .....	126, 130
Message text .....	617
Minimum clearances to the device .....	40
Mode	
Entry .....	110
Move .....	110
Mode change .....	104
MODULE ID .....	626
Mounting	
Tightening .....	42
Top-hat rail .....	41
MR, Master reset (standard FB) .....	273
Multiply .....	181
MX, data multiplexer (standard FB) .....	276
<hr/>	
<b>N</b>	
NC, Numerical converter (standard FB) .....	282
Negate, coil .....	148
Network (easyNet)	
Cables .....	63
Network connection cable .....	60
Number formats .....	119
Numerical converter, NC (standard FB) .....	282
<hr/>	
<b>O</b>	
OK button .....	110
OM, Overspeed monitoring (safety FB) .....	434
Operands	
Assigning .....	164
Assigning, FB output .....	165
Deleting on FB inputs/outputs .....	165
Operands, alphabetical list .....	639
Operating buttons, function .....	110
Operating hours counter, OT (standard FB) .....	289
Operating mode	
RUN, STOP .....	79

Operating mode change not detected (NET) .....	566
Operating mode selector switch, OS (safety FB) .	449
OS, Operating mode selector switch (safety FB) .	449
OT, Operating hours counter (standard FB) .....	289
Outputs	
Connecting .....	49
Expanding .....	73
Reset .....	273
Status display .....	26
Overload .....	55
Overspeed monitoring, OM (safety FB) .....	434

---

<b>P</b> P Buttons	
Status display .....	26
P buttons .....	142
Activating and deactivating .....	590
Parallel circuit, outputs .....	54
Parameter dialog, for function blocks .....	159
Parameter setting	
Function blocks .....	158
Parameters	
Enabling/disabling access .....	161
Passing through (network topology) .....	64
Password	
Activation .....	574
Changing .....	577
Deleting .....	577
No longer known .....	574
Password protection .....	567
Point-to-point communication .....	70
Power failure .....	79
Time switch .....	253
Power flow display .....	105
Power supply device .....	55
Process image .....	603
Programming cable .....	69
Protecting areas .....	572
PT, Put value to network (standard FB) .....	293

<b>R</b>	Range of applications .....	17
	Reaction time .....	612
	Redundant relay output .....	51
	Relay	
	Connecting outputs .....	51
	Overview .....	643
	Relays	
	Coil function .....	145
	Definition .....	113
	Reset .....	147
	Device settings via software .....	579
	Factory settings for the device .....	579
	Markers and outputs .....	273
	Retention .....	597
	Setting .....	598
	Timing relay with retentive actual values .....	320
	Retentive markers .....	118
	RJ45 socket, connection assignment .....	59
	Rotation frequency .....	513
	Rotation frequency, maximum .....	438
	RUN (mode) .....	79
	RUN/STOP changeover .....	104
	Rung .....	120
	Adding new rung .....	89
	Adding/deleting .....	139
	Changing .....	141
	Deleting .....	141
<b>S</b>	Safety circuit diagram	
	Testing .....	103
	Safety gate, SG (safety FB) .....	465
	Safety password .....	569
	Safety rules, during installation .....	39
	Safety timing relay, TS (safety FB) .....	494
	Saving	
	Circuit diagram .....	139
	Saving, Values .....	233
	SC, Set time/date (standard FB) .....	298
	Screw mounting .....	42

SE, Start element (safety FB) .....	458
Sealing the safety configuration .....	580
Sealing, safety configuration .....	580
Searching	
Contacts and coils .....	140
Self-latching, Circuit example .....	606
Set .....	147
Setting LCD backlight .....	595
Setting LCD contrast .....	595
Setting the startup behaviour .....	592
Seven day time switch, HW (standard FB) .....	246
SG, Safety gate (safety FB) .....	465
Shift register, SR (standard FB) .....	300
Short-circuit .....	55
Speed monitoring .....	434
Spur line .....	64
SR, Shift register (standard FB) .....	300
Standard password .....	570
Start element, SE (safety FB) .....	458
Startup behaviour .....	80
Station	
Addressing .....	65
Stations	
Connecting (installation) .....	63
Status display .....	26
Basic device .....	25
Local expansion .....	27
Status line, circuit diagram .....	121
STOP (mode) .....	79
Subtract .....	181
Surge impedance .....	66
Switch contact	
Change between make - break contact .....	89
Contact name .....	132
Contact number .....	132
Entering .....	88, 96, 99
Switch contact -> see Contact	
Switching on .....	77
System information .....	26

	System menu	
	Changing to .....	31
	Overview .....	33
<hr/>		
<b>T</b>	T, timing relay (standard FB) .....	315
	Table function, TB (standard FB) .....	330
	Target group .....	17
	TB, Table function (standard FB) .....	330
	Test signal outputs	
	Connecting .....	57
	Wiring example .....	153
	Testing, circuits via the P buttons .....	142
	Text display function block .....	617
	Text display, D (standard FB) .....	226
	TH, Two-hand button (safety FB) .....	481
	Threshold value switch (standard FB) .....	174
	Tightening torque (terminals) .....	44
	Time display .....	27
	Time overlaps, Time switch .....	252
	Time setting .....	584
	Time switch	
	24 hour switching .....	253
	Power failure .....	253
	Time/date setting, SC (standard FB) .....	298
	Timing relay and counter function block, example ...	337
	Timing relay, T (standard FB) .....	315
	Topology, easyNET .....	64
	T-piece and spur line (network topology) .....	64
	Transferring	
	Values to a different marker range .....	196
	TS, Safety timing relay (safety FB) .....	494
	Two-hand button, TH (safety FB) .....	481
<hr/>		
<b>U</b>	Unlocking, device .....	575

<b>V</b>	Value	
	Convert, BCD Binary .....	282
	Get value from network, GT (standard FB) .	242
	Put value to network, PT (standard FB) .....	293
	Saving .....	233
	Setting .....	37
	Value range, Markers .....	119
	Variables	
	Assigning, FB input .....	164
	Voltage range, input signals .....	47
<b>W</b>	Weekday display .....	27
	Weekday setting .....	584
	Winter time .....	585
	Wiring	
	Arrow .....	89, 137
	backwards .....	607
	Grid .....	120
<b>Y</b>	Year time switch	
	Behaviour in the event of a power failure ...	255
	Configuring the parameters for continuous	
	periods of time .....	263
	Configuring the parameters for recurring	
	intervals .....	261
	Sample parameter configurations .....	261
	Year time switch, HY (standard FB) .....	254
<b>Z</b>	Zero speed monitoring, ZM (safety FB) .....	509
	ZM, Zero speed monitoring (safety FB) .....	509
	Zoom function, in the power flow display .....	106

At Eaton, we're energized by the challenge of powering a world that demands more. With over 100 years experience in electrical power management, we have the expertise to see beyond today. From groundbreaking products to turnkey design and engineering services, critical industries around the globe count on Eaton.

We power businesses with reliable, efficient and safe electrical power management solutions. Combined with our personal service, support and bold thinking, we are answering tomorrow's needs today. Follow the charge with Eaton. Visit [eaton.com/electrical](http://eaton.com/electrical).

**Eaton addresses worldwide:**  
**[www.eaton.com/address](http://www.eaton.com/address)**

**E-Mail: [info-bonn@eaton.com](mailto:info-bonn@eaton.com)**  
**Internet: [www.eaton.com/easySafety](http://www.eaton.com/easySafety)**

**Eaton Industries GmbH**  
Hein-Moeller-Str. 7-11  
D-53115 Bonn

© 2006 by Eaton Corporation  
Alle Rechte vorbehalten  
MN05013001Z\_EN Doku/IAB 02/16



*Powering Business Worldwide*