

easyFamily
Moeller® series

Control Relay easy
MFD Titan

Compact PLC easyControl
Control Relay with SmartWire-DT

The Clever easyFamily

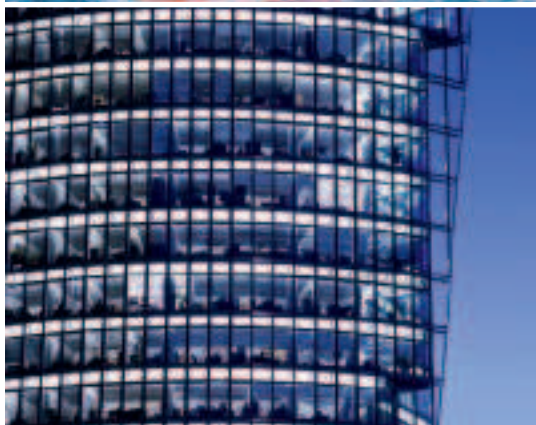

EATON
Powering Business Worldwide





The Versatile easyFamily Clever Control in Trade and Industry

The easyFamily provides a harmonized universal system from the control relay easyRelay to the multi function display MFD-Titan up to the safety-related control relay easySafety and the compact PLC easyControl. The devices are based on a common concept, and, depending on the variant, are designed to solve control tasks ranging from simple to comprehensive. The devices of the easyFamily, which exhibit a high level of functionality, also feature simple operation and handling. Their versatility make them the optimum choice for a wide-range of applications in industry, building automation and trade.



Simple control and setting

With their different performance classes easy500, easy700 and easy800, the easyRelays provide the optimum solution for small, medium and large control and setting tasks. With the easyRelays you can electronically accept existing circuit diagrams 1:1.



Simple visualization

In addition to the control and setting functions of a control relay easy800, the multi function display MFD-Titan provides versatile visualization options. The simplicity of mask design as well as the simple parameterization of ready-made visualization elements make the representation of bargraphs, bitmaps, text and values child's play.

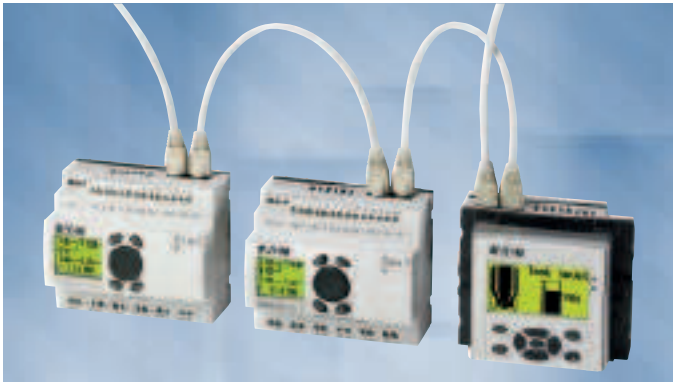
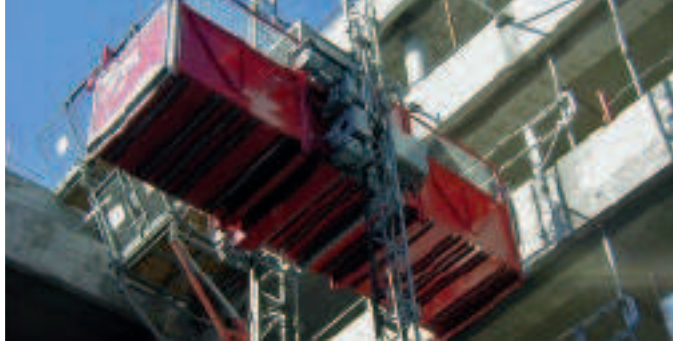

Simple to network and communicate

Devices with integrated connection for the easyNet network can be easily interconnected. Via easyNet, up to 8 devices can communicate with one another at a distance of up to 1,000 meters. Applications with up to 328 I/O points can be implemented in this way.

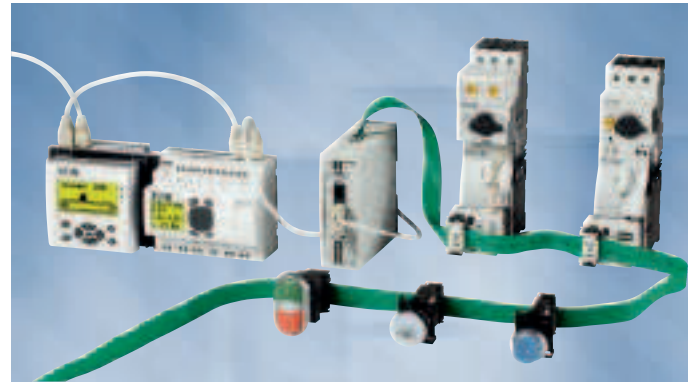

Simple to connect

The combination of a control relay easy800 with direct connection to the communication system for SmartWire-DT switchgear provides an innovative solution in control panel design and construction. The renowned simple handling of easyRelay and the efficient SmartWire-DT connection technology provide considerable savings in terms of time and costs during planning, commissioning and maintenance.

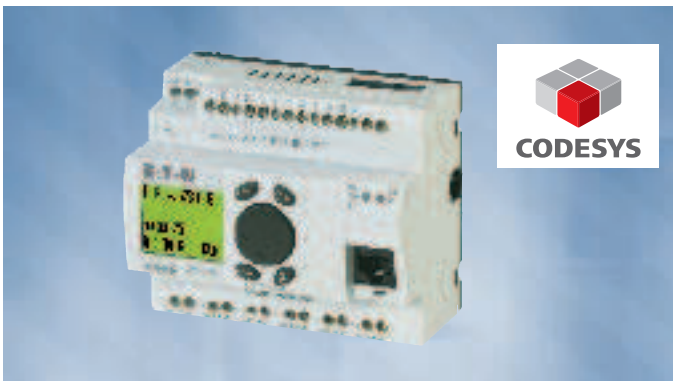

Simple to automate

easyControl as a compact PLC is optimally suited for small and medium-sized automation tasks. The integrated CANopen interface enables the connection to the easyNet network. With Ethernet on board, additional demands such as an OPC server and network programming are taken into consideration. Programming is compliant to IEC 61131-3 with XSoft CoDeSys-2.



Simple safety

The safety-oriented control relay easySafety combines safety and standard control functions efficiently in a single device. easySafety monitors all necessary safety devices on machines and systems and supports the implementation of applications, which comply with the highest safety demands.



Display, Switch, Control and Set – Simply easy



Safety Technology

Control the unexpected

More information concerning the safety-related control relay easySafety and safety technology can be found in the brochure "Safety of machines and systems" and the Safety Manual under www.eaton.eu/shb

The control relay easy500/700/800 as well as the multi function display MFD-Titan offer all the technical opportunities to implement solutions in industry and building automation, machine engineering and in apparatus construction as well as trade applications. A host of different device versions with various functions, voltage types, expansion and networking options are available for implementing the right solution. In addition to the main functions of the easy500/700, such as multifunction timer relays, counters, analog value comparators, timers, etc., the easy800 and MFD-Titan feature a host of function blocks such as PID controllers, maths functions, value scaling, and much more ... In addition to text displays, value entry and value displays with the control relays, the MFD-Titan also offers comfortable operating and visualization options, such as button functions, bitmaps or bargraphs.

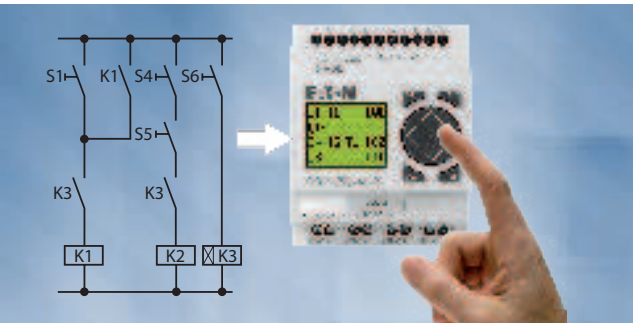

easy500

For small-scale applications with up to 12 I/O:

- 1:1 electronic circuit diagram entry
- Circuit diagram entry directly on the device possible
- 128 rungs with 3 contacts each and 1 coil in series
- Functions such as multi-function timing relays, impulse relays, counters, analog value comparators, week and year time switches, value entry, value display...
- Connection possible to Ethernet (programming and OPC functionality)



easy700

For solving medium-sized control tasks up to 40 I/O:

- Full functional range of an easy500
- 128 rungs with 3 contacts each and 1 coil in series
- Local and remote expansion
- Connection possible to standard bus systems (Profibus, CANopen, DeviceNet, As-i) and Ethernet (programming and OPC functionality)

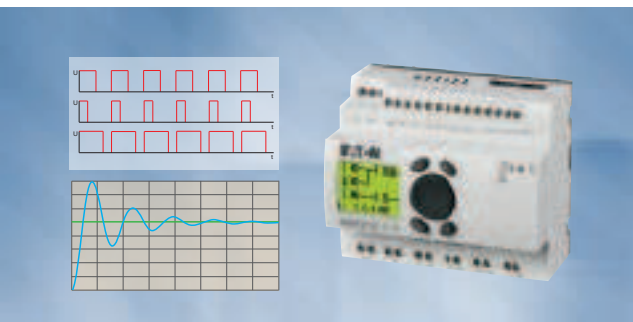

easy800

Ideal for large open-loop and closed-loop control tasks with up to 328 I/O:

- Full functional range of an easy700
- A host of additional functions such as PID controller, maths functions, pulse width modulation...
- 256 rungs with 4 contacts each and 1 coil in series
- Digital and analog expandability
- Integrated communication via easyNet (up to 8 devices – up to 1000 m)
- Connection possible to standard bus systems (Profibus, CANopen, DeviceNet, As-i) and Ethernet (programming and OPC functionality)



easy800 with SmartWire-DT

Combines the functions of an easy800 with the direct connection to the communication system for switchgear SmartWire-DT (SW-DT):

- Exchange of data as well as power supply for the SmartWire-DT devices and contactors via the communication system SmartWire-DT
- Up to 99 SmartWire-DT devices in total with up to 166 inputs/outputs can be connected
- easyNet as well as 4 additional fast inputs, 2 of which can be used as fast outputs
- Serial interface for programming or for connection of a remote text display or touch panel or for connection to the Ethernet



MFD Titan

Combines the functions of an easy800 with comfortable visualization for larger applications with up to 320 I/Os:

- Fast and easy to install in 22.5 mm standard fixing holes
- I/O modules for direct temperature measuring (Pt100 / Ni1000)
- Individual laser inscription of devices, for example with own company name or logo
- Digital and analog expandability
- Communication via easyNet possible (up to 8 devices – up to 1000 m)
- Connection possible to standard bus systems (PROFIBUS-DP, CANopen, DeviceNet, As-i) and Ethernet (programming and OPC functionality)



easyControl

High-performance CPU with large programming memory (256kB) and versatile communication functions:

- CANopen / easyNet bus interface for connection to distributed peripherals
- RS232 / Ethernet programming interface
- Comfortable programming to IEC1131-3 in Ladder Diagram, Function Block Diagram, Instruction List, Structured Text, Sequential Function Chart, Continuous Flow chart
- Powerful libraries for control engineering and communication



Direct Circuit Diagram Entry – Simply easy Control Relay easy500/700

Anyone who can read circuit diagrams immediately feels at home with easyRelay. With the easyRelay, you can electronically accept existing circuit diagrams 1:1. It is possible to directly enter the circuit diagrams on the device. Whether it is a compact device or an expanded variant – easyRelay stands out with its simple operation and handling features.



easy500/700 are used in the electrical trade for a wide range of control tasks, e.g. illumination control.

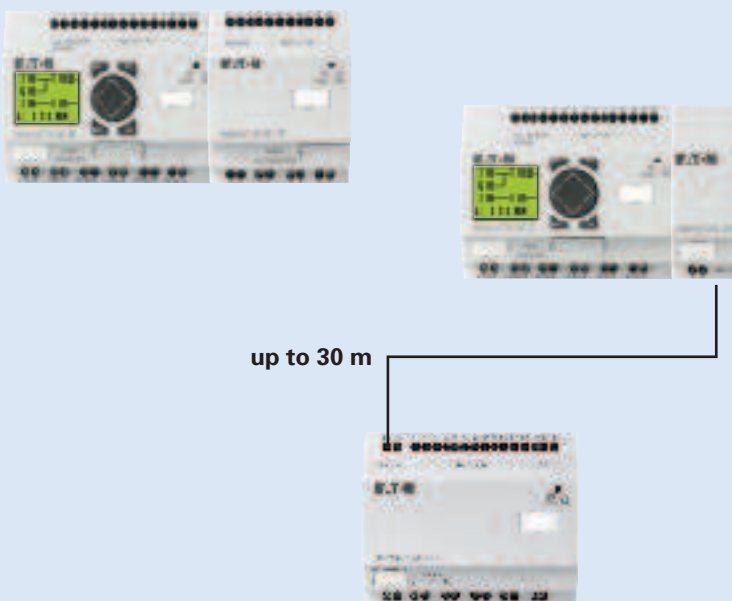

Local and remote expandability

easy700 is digital and can be expanded by up to 40 inputs/outputs. For this purpose, the easy expansion is directly connected locally to the basis device via the side-mounted easyLink interface. The coupling module EASY200-EASY and a simple 2-wire cable up to 30 m in length provide an alternative to the distributed connection of a digital expansion device. Furthermore, easy700 provides the option for the connection of bus modules via easyLink and thus the connection to a higher-level bus systems.

Functions

- 16 counting relays (0 to 32000, up and down counter relays)
- 2 frequency counters (max. 1 kHz)
- 2 high-speed frequency counters (max. 1 kHz)
- 4 operating hours counters (the operating hours value is super retentive, i.e. also retained with program change)
- 8 week time switches (4 channels per time switch, 1 on/off point per channel)
- 8 year time switches
- 16 timing relays (0.01 s – 99 h 59 min, on-delayed and/or off-delayed (optional random switching), single pulse, flashing)
- 8 jump function blocks
- 3 master reset function blocks
- 16 analog value comparators
- 16 comparators
- 16 text displays (4 x 12 characters, editable via programming software)
- Value entry (counter values, setpoints, ...)
- Value display (actual values, ...)
- Date and time entry

	Inputs		Outputs		Further features		Supply voltage	Part no. Article no.
	Digital	Can be used for analog	Relay 10 A (UL)	Transistor	Display + keypad	Real-time clock		
easy500								
Stand alone								
	8	2	4	-	●	●	24 V AC	EASY512-AB-RC 274101
	8	2	4	-	-	●	24 V AC	EASY512-AB-RCX 274102
	8	-	4	-	●	-	100-240 V AC	EASY512-AC-R 274103
	8	-	4	-	●	●	100-240 V AC	EASY512-AC-RC 274104
	8	-	4	-	-	●	100-240 V AC	EASY512-AC-RCX 274105
	8	2	4	-	●	●	12 V DC	EASY512-DA-RC 274106
	8	2	4	-	-	●	12 V DC	EASY512-DA-RCX 274107
	8	2	4	-	●	-	24 V DC	EASY512-DC-R 274108
	8	2	4	-	●	●	24 V DC	EASY512-DC-RC 274109
	8	2	4	-	-	●	24 V DC	EASY512-DC-RCX 274110
	8	2	-	4	●	●	24 V DC	EASY512-DC-TC 274111
	8	2	-	4	-	●	24 V DC	EASY512-DC-TCX 274112
easy700								
Expandable: Digital inputs/outputs and bus systems AS-Interface, PROFIBUS-DP, CANopen, DeviceNet								
	12	4	6	-	●	●	24 V AC	EASY719-AB-RC 274113
	12	4	6	-	-	●	24 V AC	EASY719-AB-RCX 274114
	12	-	6	-	●	●	100-240 V AC	EASY719-AC-RC 274115
	12	-	6	-	-	●	100-240 V AC	EASY719-AC-RCX 274116
	12	4	6	-	●	●	12 V DC	EASY719-DA-RC 274117
	12	4	6	-	-	●	12 V DC	EASY719-DA-RCX 274118
	12	4	6	-	●	●	24 V DC	EASY719-DC-RC 274119
	12	4	6	-	-	●	24 V DC	EASY719-DC-RCX 274120
	12	4	-	8	●	●	24 V DC	EASY721-DC-TC 274121
	12	4	-	8	-	●	24 V DC	EASY721-DC-TCX 274122



Using Clever Functions – Simply easy Control Relay easy800

With its versatile function blocks such as the PID controller, maths function, pulse width modulation, etc., the easy800 offers versatile solutions for control and setting tasks in industry and trade. The digital and analog expandability, the option for connection to the standard bus systems and Ethernet as well as the networkability via easyNet make the easy800 the most powerful control relay on the market.



easy800 can be installed in the control panel as well as in the service distribution board.



Convenient Access to easy800 using Bluetooth

The EASY800-BLT-ADP Bluetooth adapter facilitates convenient online functionality for easy800, MFD-Titan or easyControl using easySoft-Pro or CODESYS. It allows applications to be transferred to the corresponding PLC, tested, commissioned, serviced and run through troubleshooting conveniently away from loud, dangerous areas. The free easyRemote display app for the easy800 also offers convenient access for Android smartphones to all available display and operating functions for the control relay – almost like working on the device itself. Users can view texts and values, change parameters, check and edit the circuit diagram, set the date and time and change the operating mode.

Download easyApp from



Functions

- 32 Counting relays (+/-2³¹, up and down counter relays)
- 4 frequency counters (max. 5 kHz)
- 4 high-speed frequency counters (max. 5 kHz)
- 2 incremental value counters (max. 3 kHz)
- 4 operating hours counters (operating hours value is super retentive, i.e. also retained with program change)
- 32 weekly time switches (4 channels per time switch, 1 on/off point per channel)
- 32 year time switches
- 1 set cycle time function block
- 32 timing relays (0.005 s – 2³² min, on-delayed and/or off-delayed (optional random switching), single pulse, flashing)
- 32 jump function blocks
- 32 conditional jump function blocks
- 32 master reset function blocks
- 32 analog value comparators
- 32 comparators (ADD, SUB, MUL, DIV)
- 32 PID controllers
- 32 PT1 signal smoothing filter
- 32 value scaling function blocks
- 32 numerical converters
- 2 pulse output function blocks
- 2 pulse width modulation function blocks
- 32 value limitation function blocks
- 32 block comparison function blocks
- 32 block transfer function blocks
- 32 Boolean operation (AND, OR, NOT)
- 32 comparators
- 32 data function blocks
- 32 data multiplexer
- 32 shift registers
- 32 table functions
- 32 get value from NET function blocks
- 32 put value in NET function blocks
- 32 bit output from NET function blocks
- 32 bit input from NET function blocks
- 9 diagnostics alarms
- 32 serial protocol function blocks
- 1 synchronize clock via NET function blocks
- 32 text displays (4 x 16 characters, editable via programming software)
- Value entry (counter values, setpoints, ...)
- Value display (actual values, ...)
- Date and time entry
- Date and time display

	Inputs		Outputs		Analog	Further features		Supply voltage	Part no. Article no.
	Digital	Can be used for analog	Relay 10 A (UL)	Transistor		Display + keypad	Real-time clock		
easy800									
Expandable: Digital inputs/outputs and bus systems AS-Interface, CANopen, PROFIBUS-DP, DeviceNet, Bus system easyNet on board customized laser inscription with EASY-COMBINATION * possible									
	12	-	6	-	-	•	•	100-240 V AC	EASY819-AC-RC 256267
	12	-	6	-	-	-	•	100-240 V AC	EASY819-AC-RCX 256268
	12	4	6	-	-	•	•	24 V DC	EASY819-DC-RC 256269
	12	4	6	-	-	-	•	24 V DC	EASY819-DC-RCX 256270
	12	4	6	-	1	•	•	24 V DC	EASY820-DC-RC 256271
	12	4	6	-	1	-	•	24 V DC	EASY820-DC-RCX 256272
	12	4	-	8	-	•	•	24 V DC	EASY821-DC-TC 256273
	12	4	-	8	-	-	•	24 V DC	EASY821-DC-TCX 256274
	12	4	-	8	1	•	•	24 V DC	EASY822-DC-TC 256275
	12	4	-	8	1	-	•	24 V DC	EASY822-DC-TCX 256276

Description	Part no. Article-no.
Bluetooth-Adapter  Programmer and communications adapter for secure Bluetooth connection between controller and PC/Smartphone, from up to 10m away	EASY800-BLT-ADP 167651



Connecting Instead of Wiring – Simply easy Control Relay easy800 with SmartWire-DT

The new easy800 with SmartWire-DT combines the functions of an easy800 with the direct connection to the communication system for switchgear SmartWire-DT. Instead of connecting the inputs and outputs individually to a control, they are simply connected via a SmartWire-DT line to the new easy800 with SmartWire-DT. Programming is implemented in the usual way in a ladder diagram using the programming software easySoft-Pro. The new control relays combine the simplicity of two systems and represent an innovative solution in the field of control panel design.



easy800 with SmartWire-DT controls control circuit devices – easily, quickly and efficiently.



COM

Quick to connect, simple to control and display

On the easy800 you can quickly and efficiently connect control circuit devices, motor-protective circuit-breakers, contactors as well as input/output modules via SmartWire-DT. The connection of a remote text display via the serial programming interface facilitates the display of texts as well as the display and entry of values.

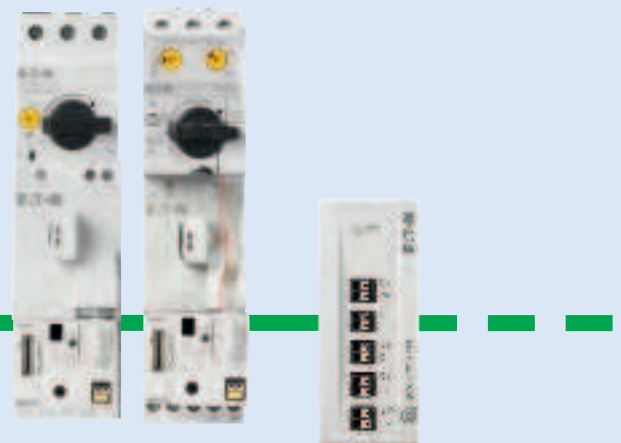

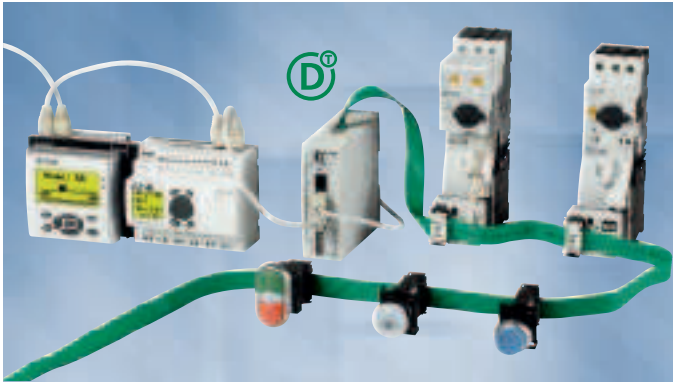

SmartWire-DT

SmartWire-DT is a high-performance system that can be used to quickly and easily connect switchgear such as contactors, motor-protective circuit-breakers, control circuit devices as well as digital and analog input/output modules. On the new easy800 with integrated SmartWire-DT master, up to 99 SmartWire-DT devices in total with up to 166 inputs/outputs can be connected via the SmartWire-DT line. All required supply voltages, including those for the bus devices as well as 24 V DC for the contactors are provided directly with the flat 8-pole SmartWire-DT bus line. This saves wiring effort and troubleshooting and saves time and costs.

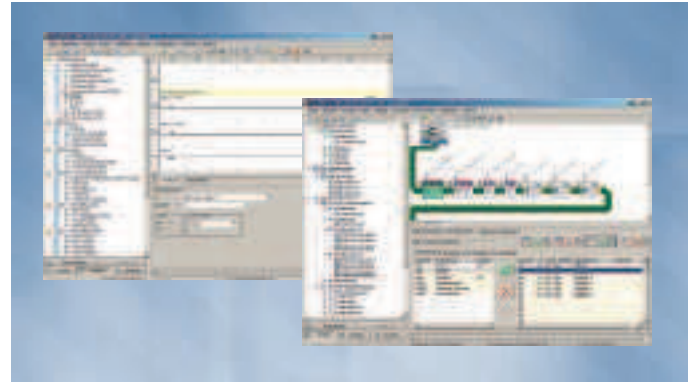

easySoft-Pro

The programming software easySoft-Pro for SmartWire-DT has been extended with the SmartWire-DT configurator. Using the configurator, the SmartWire-DT line is created with all devices. The SmartWire-DT devices are subsequently assigned with the operands. This can be undertaken manually or automatically as required. Switches and contacts are assigned to the inputs I17 to I99 and contactor coils and indicator lights to the outputs Q17 to Q99. Value inputs or outputs, such as those from motor-protective circuit-breakers, make up the well-known easy800 marker ranges (optional marker bytes, marker words and double words). The operands can be used in the accustomed manner in the circuit diagram – simply easy!





EASY802-DC-SWD

EASY802-DC-SWD features a POW power supply for supplying power to the device as well as the SmartWire-DT devices. A second AUX power supply provides the connected contactors with 24 V DC. The configuration of the SmartWire-DT devices is undertaken at a touch of the provided Configuration button. LEDs provide feedback concerning the states on the device and the SmartWire-DT line. The serial interface serves for programming as well as for connection of a remote text display, touch panel or for connection to the Ethernet.



EASY806-DC-SWD

In addition to the functionality of the EASY802-DC-SWD, the EASY806-DC-SWD also features 4 fast inputs (5 KHz). 2 of the 4 inputs can also be configured as fast outputs (5 KHz) (transistor 24 V DC, 0.1 A). In addition to the additional inputs/outputs on EASY806-DC-SWD, there is a connection option to the easyNet. In this way, up to 1360 inputs/outputs can be connected.

	Supply voltage	Description	Part no. Article no.
easy800 with SmartWire-DT			
Control relay for connection of SmartWire-DT and simultaneously for supply of power to the SmartWire-DT devices, such as switchgear and contactors			
	24 V DC	Control relay with SmartWire-DT	EASY802-DC-SWD 152901
	24 V DC	Control relay with SmartWire-DT, 4 inputs, 2 of which can be used as outputs (transistor 24 V DC, 0.1 A), easyNet on board	EASY806-DC-SWD 152902



Visualization, Control, Setting – Simply easy Multi Function Display MFD-Titan

In addition to the control and setting functions of a control relay easy800, the multi function display MFD-Titan provides versatile visualization options. The MFD-Titan offers the display of text, bar graphs, bitmaps and much, much more, as well as value entry and display functions. Operating menus or acknowledgement of errors are simple to implement with MFD-Titan.

Protection to IP65 means that the display can be used in aggressive environments.



MFD-Titan takes over the function of the operator interface in the helmstand for crane systems, e.g. for visualization of error messages and operating states.

Flexible design, simple installation

The MFD-Titan stands out with its modular design. The individual modules include the display and operator unit, the power supply/CPU module as well as an input and output module. MFD-Titan can thus be used in different combinations.



Installation of the display and operator is fast and easy in 22.5 mm standard fixing holes. Then the individual modules are simply snapped on. Ready to go!

Creation of a visualization system

Creation of a visualization system on MFD-Titan is implemented by simply creating screens. The comfortable screen editor in easySoft-Pro provides a range of pre-defined screen elements for this purpose. Message tests, value displays and entries, error messages and graphics, etc. can be easily added and parameterized. Operating menus are easy to create, and the individual function keys can be individually assigned.



Direct temperature measuring

With the input/output modules for temperature measurement, the MFD-Titan provides the option of direct connection of Pt100 and Ni1000 sensors. The modules feature a precise 12 bit resolution and adjustable temperature ranges. Thus the MFD-Titan is ideally suited for temperature controls.



New power supply/CPU module MFD-CP10

The new power supply/CPU module MFD-CP10 now offers much more memory for function blocks and visualizations. The MFD-Titan is now even more powerful with its faster processing speeds, the higher number of retentive markers, the additional multiplex module and the option of switching the text language during operation.



Individual laser inscription

On the easyRelay, easyControl and MFD-Titan, it is possible to create your own company and project-related laser inscriptions for the devices. The free "LabelEditor" software is available to quickly create laser inscription templates. Marked fields provide the possible inscription surfaces. Simply place, e.g. the company name or logo, and send the inscription template to us – we will supply your customized device. With the display/operator unit MFD-80-(B), individual laser inscription of the function keys and LEDs is possible.

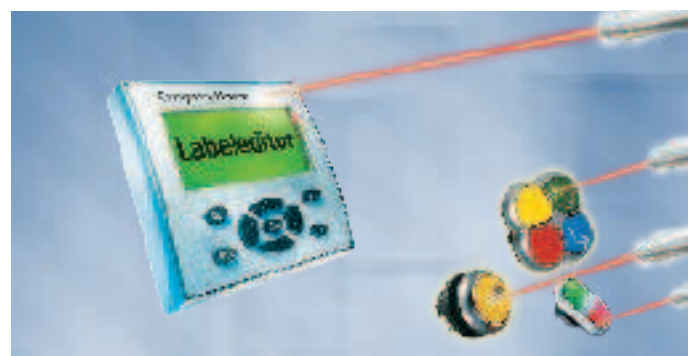

Remote text display

The display/operator unit MFD-80-(B) and the power supply/CPU module MFD-CP4 can be used as a remote text display. It is possible to connect them to easyRelay, easyControl and easySafety. The text display can be used to display text, as well as to enter and display values up to 5 m from the basis unit. All without additional programming – simply "Plug&Work". Connect the basis device and the remote display using the appropriate cable, and all display content of the basis unit is shown at a remote location.



Functions

- 32 counting relays (+/-2³¹, up and down counter relays)
- 4 frequency counters (max. 3 kHz)
- 4 high-speed frequency counters (max. 3 kHz)
- 2 incremental value counters (max. 3 kHz)
- 4 operating hours counters (operating hours value is super retentive, i.e. also retained with program change)
- 32 weekly time switches (4 channels per time switch, 1 on/off point per channel)
- 32 year time switches
- 1 set cycle time function block
- 32 timing relays (0.005 s – 2³² min, on-delayed and/or off-delayed (optional random switching), single pulse, flashing)
- 32 jump function blocks
- 32 conditional jump function blocks
- 32 master reset function blocks
- 32 analog value comparators
- 32 comparators (ADD, SUB, MUL, DIV)
- 32 PID controllers
- 32 PT1 signal smoothing filter
- 32 value scaling function blocks
- 32 numerical converters
- 2 pulse width modulation function blocks
- 32 value limitation function blocks
- 32 block comparison function blocks
- 32 block transfer function blocks
- 32 Boolean operation (AND, OR, NOT)
- 32 comparators
- 32 data function blocks
- 32 x data multiplexer (with MFD-CP10..)
- 32 shift registers
- 32 table functions
- 32 get value from NET function blocks
- 32 put value in NET function blocks
- 32 bit output from NET function blocks
- 32 bit input from NET function blocks
- 9 diagnostics alarms
- 1 synchronize clock via NET function blocks

Visualization elements

- Static text
- Message text
- Screen menu
- Running text
- Rolling text
- Date and time display
- Numerical value display (actual values, ...)
- Timing relay value display
- Value entry (counter values, setpoints, ...)
- Timing relay value entry
- Date and time entry
- Week time switch entry
- Year time switch entry
- Latching button
- Button field
- Bit display
- Bitmap
- Message bitmap
- Bargraph

Versatile use

The MFD-Titan can be used as a control, setting and visualization unit (MFD-CP8/CP10) or as a remote text display (MFD-CP4). In easyNet, the MFD-Titan offers the opportunity to display values and states of all easyNet devices. The function keys are used for menu-guidance or for entering values and are freely programmable.

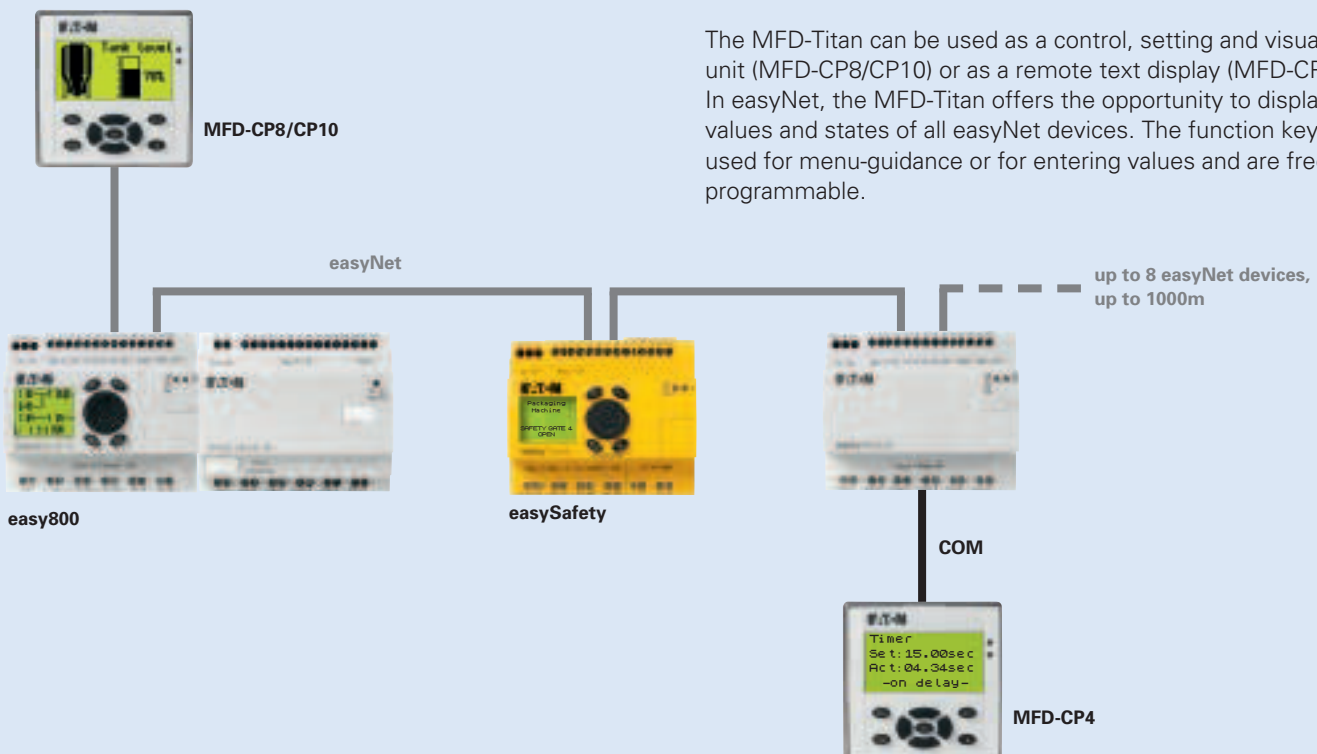

Description		Part no. Article no.
Display / operator unit		
Monochrome display 132 x 64 pixels with switchable backlight IP65, removable Titan front frame		
	with keypad, with Eaton logotype NEMA 4x in conjunction with MFD-XM-80 protective diaphragm	MFD-80-B 265251
	with keypad, without Eaton logotype NEMA 4x in conjunction with MFD-XM-80 protective diaphragm	MFD-80-B-X 284905
	without keypad, with Eaton logotype NEMA 4x	MFD-80 265250
	without keypad, without Eaton logotype NEMA 4x	MFD-80-X 284904

Supply voltage	Description	Part no. Article no.	
Power supply/CPU modules			
Combinable with MFD-80-.. display/operator unit and I/O module; expandable: digital/analog inputs/outputs and bus systems AS-Interface, CANopen, PROFIBUS-DP, DeviceNet; easyNet bus system optional on board, IP20, spring-loaded terminals			
	100 - 240 V AC	Program and screen memory	MFD-AC-CP8-ME 274091
	100 - 240 V AC	Program and screen memory, with easyNet	MFD-AC-CP8-NT 274092
	24 V DC	Program and screen memory	MFD-CP8-ME 267164
	24 V DC	Program and screen memory, with easyNet	MFD-CP8-NT 265253
	24 V DC	Double program and screen memory (as MFD-CP8)	MFD-CP10-ME 133801
	24 V DC	Double program and screen memory (as MFD-CP8), with easyNet	MFD-CP10-NT 133800

Supply voltage	For use with	Inputs			Outputs			Temperature ranges	Part no. Article no.	
		Digital	Can be used for analog	Pt100	Relay 10 A (UL)	Transistor	Analog			
I/O modules										
	24 V DC	MFD-CP8... MFD-CP10...	12	4	-	4	-	-	-	MFD-R16 265254
	24 V DC	MFD-CP8... MFD-CP10...	12	4	-	-	4	-	-	MFD-T16 265255
	24 V DC	MFD-CP8... MFD-CP10...	12	4	-	4	-	1	-	MFD-RA17 265364
	24 V DC	MFD-CP8... MFD-CP10...	12	4	-	-	4	1	-	MFD-TA17 265256
	100-240 V DC	MFD-AC-CP8...	12	-	-	4	-	-	-	MFD-AC-R16 274093

I/O modules with temperature detection										
	24 V DC	MFD-CP8... from device version 08, MFD-CP10	6	2	2	-	4	-	-40...+90°C 0...+250°C 0...+400°C	MFD-TP12-PT-A 106042
			6	2	2	-	4	-	-200...+200°C 0...+850°C	MFD-TP12-PT-B 106043
			6	2	-	-	4	-	-40...+90°C 0...+250°C	MFD-TP12-NI-A 106044
			6	2	2	-	4	1	-40...+90°C 0...+250°C 0...+400°C	MFD-TAP13-PT-A 106045
			6	2	2	-	4	1	-200...+200°C 0...+850°C	MFD-TAP13-PT-B 106046
			6	2	-	-	4	1	-40...+90°C 0...+250°C	MFD-TAP13-NI-A 106047



Full Power in a Small Space – Simply easy Compact Control easyControl

easyControl in the enclosure of the well-known easy800 control relay offers the performance of a PLC. Equipped with a powerful processor and a large memory capacity, small to medium automation tasks can be comfortably mastered. The versatile communication options via easyNet, CANopen and Ethernet open up a wide range of applications. Connection to higher-level controls via standard fieldbus systems is possible. The display can be used for comfortable display of diagnostic messages or for parameterization of the application. Programming of easyControl is compliant to IEC 61131-3 with XSoft CoDeSys-2.



easyControl controls the refrigeration units, e.g. in cold-storage areas for food.

Flexible expansion and display

As well as its local expansion capability, the device can also be expanded via CANopen. The remote CANopen EC4E modules can be used for expansions. Additional expansions can also be connected to these. A remote text display can be connected to easyControl via CANopen (MFD-CP4-CO) or serially (MFD-CP4).

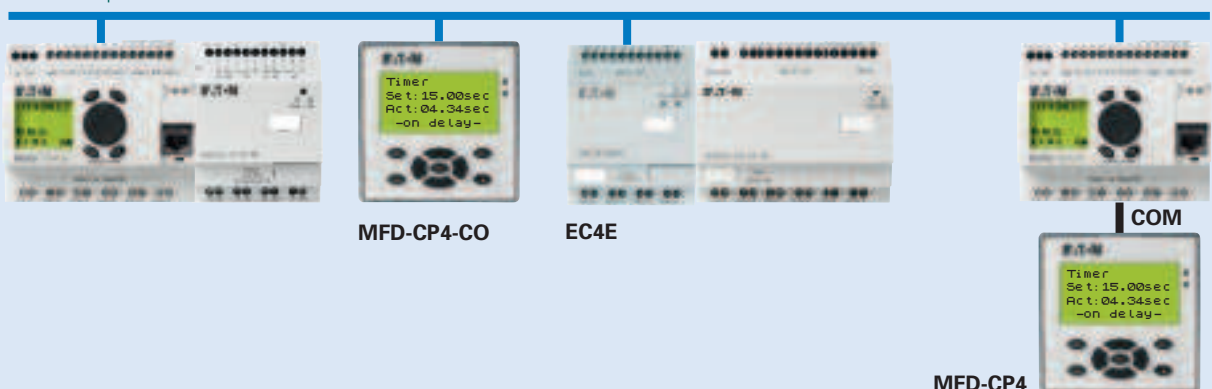

Functions

- Variable I/O configurations with digital and analog inputs, outputs optionally in transistor/relay versions. Optional analog output.
- Ethernet on board
easyControl can be comfortably programmed via the integrated Ethernet interface. Communication to other controls (UDP, TCP, Modbus-TCP) as well as to higher-level systems via OPC is possible.
- 2 serial interfaces
These are used for programming access, or free interfaces are used for communication with other serial end devices.
- Plug-in memory slot with standard file system
Programs or the operating system can be updated via the plug-in memory module (RS-MMC). Reading/writing of operating data for tracing or archiving is possible. The files can be read on every PC (e.g. EXCEL).

	Inputs		Digital outputs		Analog outputs	Ethernet	Display + keypad	Part no. Article no.
	Digital	Can be used for analog	Relay	Transistor				
EC4P								
<ul style="list-style-type: none"> • CANopen/easyNet interface • Approvals UL/CSA • Shipping classifications DNV, GL, ABS, BV, LR 								
	12	4	-	8	-	-	●	EC4P-221-MTXD1 106391
	12	4	-	8	-	-	-	EC4P-221-MTXX1 106392
	12	4	6	-	-	-	●	EC4P-221-MRXd1 106393
	12	4	6	-	-	-	-	EC4P-221-MRXX1 106394
	12	4	-	8	1	-	●	EC4P-221-MTAD1 106395
	12	4	-	8	1	-	-	EC4P-221-MTAX1 106396
	12	4	6	-	1	-	●	EC4P-221-MRAD1 106397
	12	4	6	-	1	-	-	EC4P-221-MRAX1 106398
	12	4	-	8	-	●	●	EC4P-222-MTXD1 106399
	12	4	-	8	-	●	-	EC4P-222-MTXX1 106400
	12	4	6	-	-	●	●	EC4P-222-MRXd1 106401
	12	4	6	-	-	●	-	EC4P-222-MRXX1 106402
	12	4	-	8	1	●	●	EC4P-222-MTAD1 106403
	12	4	-	8	1	●	-	EC4P-222-MTAX1 106404
	12	4	6	-	1	●	●	EC4P-222-MRAD1 106405
	12	4	6	-	1	●	-	EC4P-222-MRAX1 106406





Reliable Supply, Flexible Expansion and Networking, Simple Communication

The basis devices of the easyFamily with expansion capability facilitate the connection of a central or distributed input/output expansion. For central expansion, the digital and analog expansion devices easy4... and easy6... are available. The EASY202-RE expansion offers two additional relay outputs. The coupling module EASY200-EASY and a simple 2-wire cable up to 30 m in length provide an alternative to the distributed connection of the digital expansion devices. Devices with integrated connection for the easyNet network can be easily interconnected to each other. The easyPower primary switch mode power supplies ensure reliable supply to the devices. They are optimally matched to the easyFamily in terms of their functionality and design.

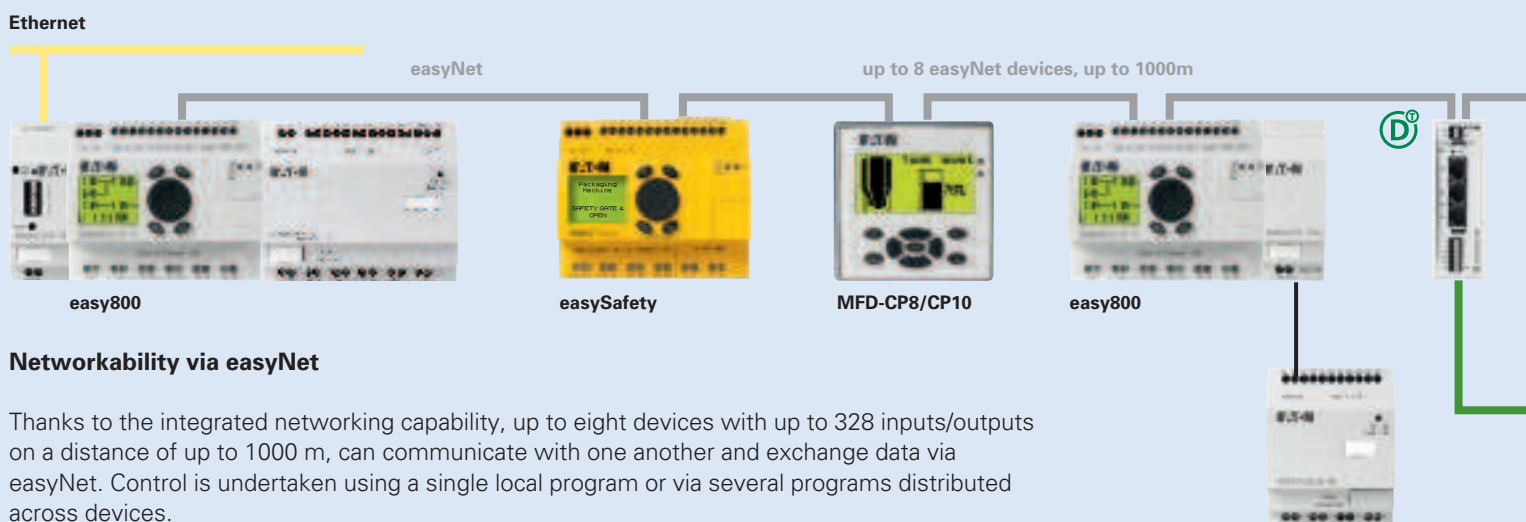

Distributed pumping stations are networked to each other and data is thus exchanged via easyNet.



	Digital inputs	Outputs		Supply voltage	Part no. Article no.
		Relay 10 A (UL)	Transistor		
Input/output expansions					
can be used via easyLink 	12	6	-	100-240 V AC	EASY618-AC-RE 212314
	12	-	8	24 V DC	EASY620-DC-TE 212313
	12	6	-	24 V DC	EASY618-DC-RE 232112
	-	2	-	24 V DC	EASY202-RE 232186
	6	4	-	24 V DC	EASY410-DC-RE 114293
	6	-	4	24 V DC	EASY410-DC-TE 114294
	For distributed connection of a digital input/output expansion at up to 30m distance				
via CANopen can be used for: XC100/200, EC4P, XV 	6	4	-	24 V DC	EC4E-221-6D4R1 114296
	6	-	4	24 V DC	EC4E-221-6D4T1 114297

	Inputs		Digital outputs		Analog outputs	Supply voltage	Part no. Article no.
	Digital/ analog	Can be used for digital	Relay 10 A (UL)	Transistor			
Input/Output Expansions							
can be used via easyLink 	1 / 2	2	-	2	1	24 V DC	EASY406-DC-ME 114295
	1 / 6	2	-	2	2	24 V DC	EASY411-DC-ME 116567

	Input voltage range	Rated output voltage	Output voltage setting range	Rated output power	Rated output current	Part no. Article no.
	Power supply units, 1-phase					
<ul style="list-style-type: none"> Rated input voltage 100 - 240 V AC 	85 - 264 V AC	24 V DC / 12 V DC	-	8 W	0.35 A / 20 mA	EASY200-POW 229424
	85 - 264 V AC	24 V DC	-	30 W	1.25 A	EASY400-POW 212319
	85 - 264 V AC	24 V DC	-	60 W	2.5 A	EASY500-POW 110941
	85 - 264 V AC	24 V DC	-	100 W	4.2 A	EASY600-POW 262399

Communication and data exchange

In addition to the communication via easyNet, it is possible to exchange data with higher-level automation systems. Bus modules for connection to the AS-i, PROFIBUS-DP, CANopen and DeviceNet are available for this purpose. With the EASY209-SE, a connection possibility is available from easyRelay and MFD-Titan to the Ethernet. This facilitates remote access and programming via easySoft, as well as OPC functionality.



easyControl



MFD-CP8/CP10



easy800

SmartWire-DT



CANopen



DeviceNet



Comfort and Versatile Visualization and Control – Simply easy

The connection of easyRelay, easySafety or easyControl and the Touch Panels XV enables high-performance visualization options. The XV Touch Panels with a size of 3.5" to 15" offer the optimum solution for every machine and system. The simple connection is implemented serially or via easyNet with easyRelay and easySafety. With easyControl also via CAN.



The touch panel visualizes the application and serves as the operator interface.

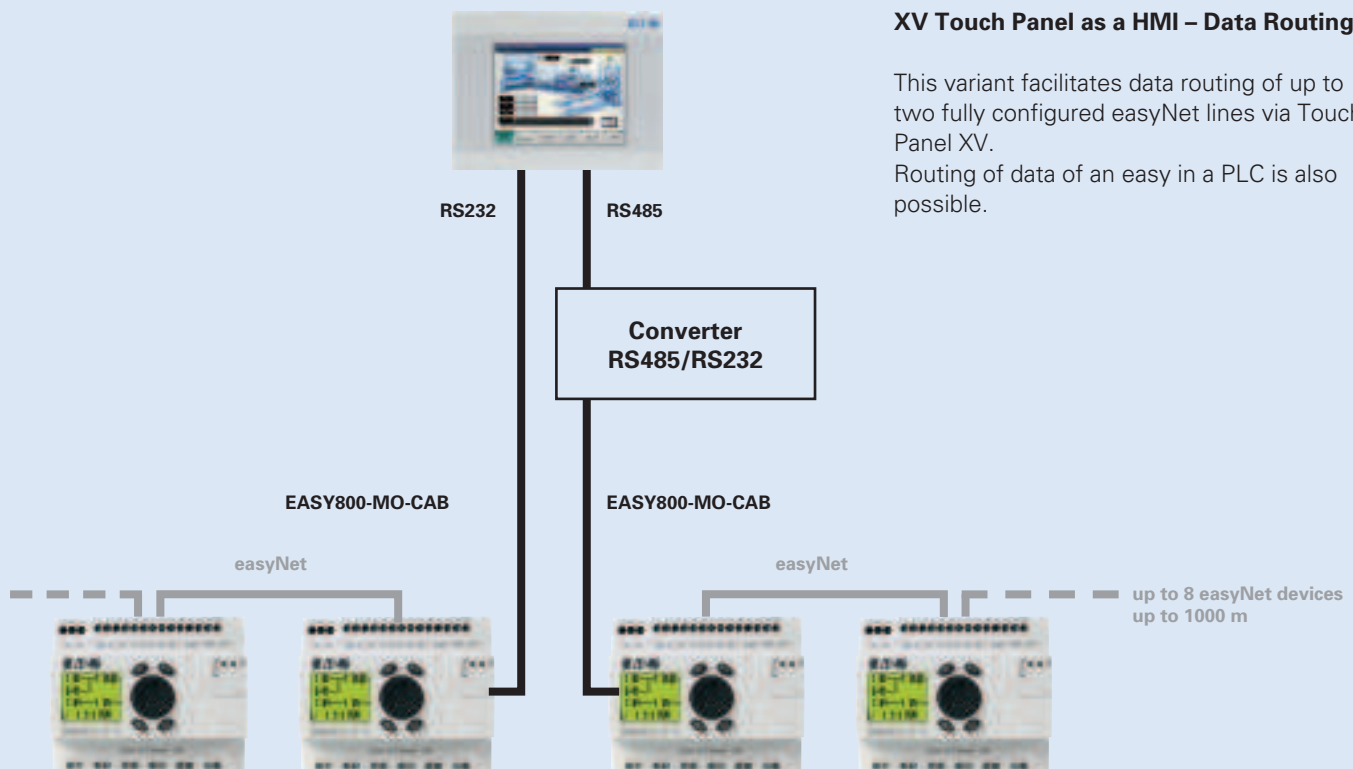

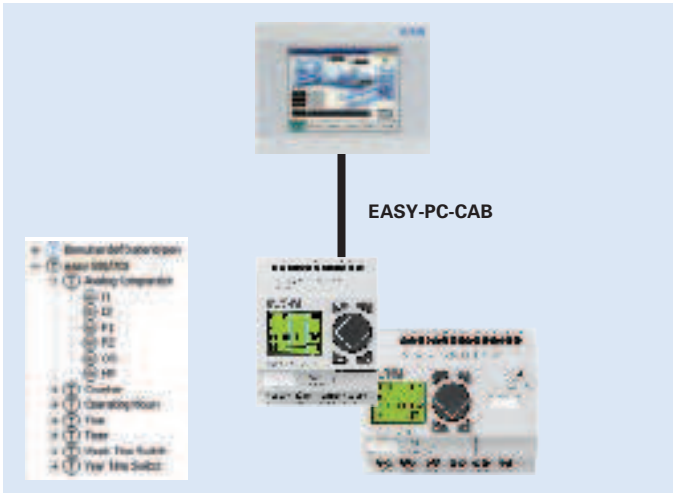

easy500/700 with XV Touch Panel as a HMI

Via the programming line EASY-PC-CAB, control relays such as the easy500/700 can be connected to the XV Touch Panels. The touch panel reads data from the control relay or writes setting values to it. easy500/700 assumes the control of the application. Display and operation are implemented through the comfortable visualisation options of the HMIs. This was created using the GALILEO visualization software. After selecting "easy 500/700" in Communications, the corresponding data types for the control relay are automatically created in GALILEO in the correct structure. This provides the visualization software with convenient access to the function block parameters for easy, allowing them to be linked to the visualization elements.

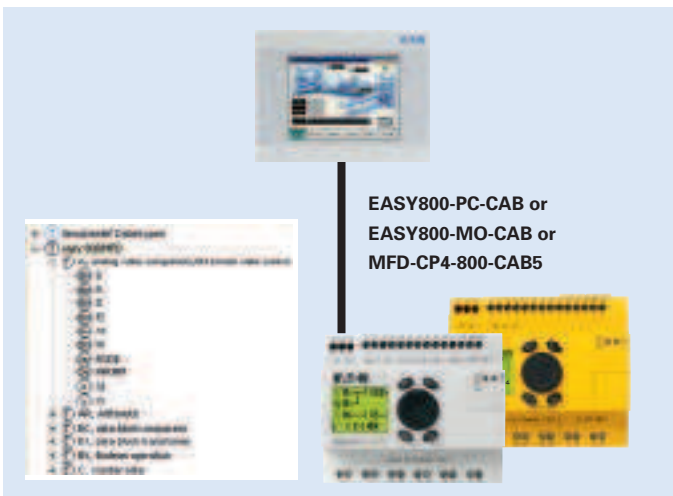

easy800 with XV Touch Panel as a HMI

In addition to the connection of easy800 and easySafety to an XV Touch Panel via the programming cable EASY800-PC-CAB, a connection via EASY-MO-CAB is also possible. Baud transfer rates up to 57600 Baud can be implemented here. Both cables are about 2 m in length. The MFD-CP4-800-CAB5 facilitates an extended cable length up to 5 m between the devices. As with easy500/700, the touch panel accesses the control relay data via the GALILEO visualization software. In Communications, select "easy 800/MFD" and enjoy easy access to the function block parameter for the control relay.

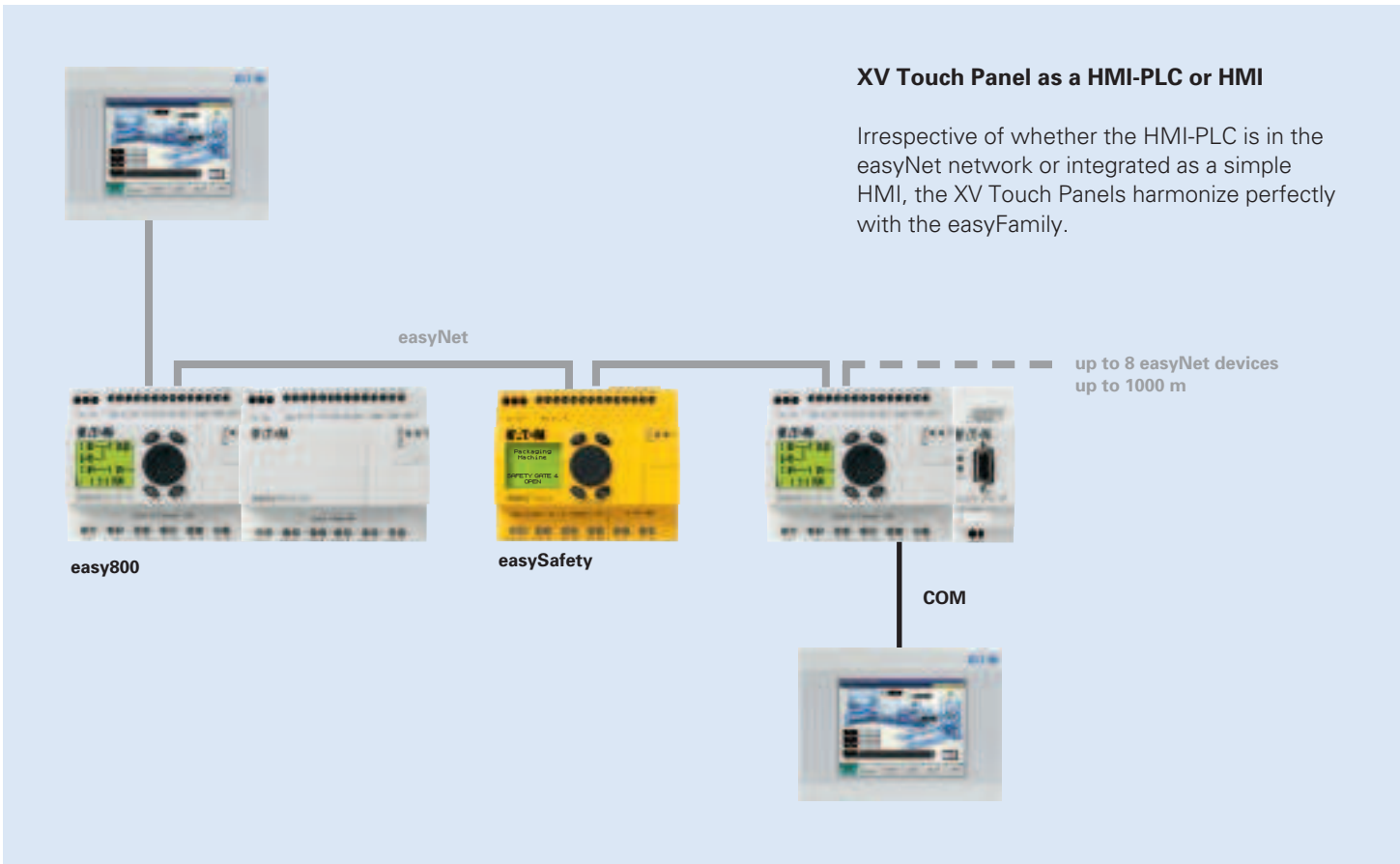

XV Touch Panel as a HMI-PLC or HMI

Irrespective of whether the HMI-PLC is in the easyNet network or integrated as a simple HMI, the XV Touch Panels harmonize perfectly with the easyFamily.



Direct Circuit Diagram Entry or Comfortable Programming – Simply easy

easySoft makes life particularly easy for the user. The intuitive software enables a quick entry to the programming of easyRelay and MFD-Titan. Creation of a circuit diagram is implemented using a simple ladder diagram. "Drag&Drop" functions simplify the establishment of links to contacts and coils. Clear selection menus enable quick parameterization of function blocks. XSoft-CoDeSys is used for programming easyControl and the HMI-PLCs. The IEC 61131-3 compliant standardized software stands out due to its tried-and-tested technical features, simple handling and its wide dissemination in the world of automation. The high-performance visualization software GALILEO helps the user to create a comfortable visualization for the touch panel.



The on-line communication of the easySoft simplifies commissioning.



Access via Ethernet

easyRelay and easyControl offer the opportunity for remote programming via Ethernet and the access via OPC. The easySoft-Pro CD also contains a free-of-charge OPC server, which enables the standardized inclusion of higher-level control systems (OPC clients).

Ethernet



easyRelay



easyControl



easySoft-Basic

The programming software easySoft-Basic is used for programming **easy500/700**. "Drag & Drop" functions enable quick and comfortable entry of the circuit diagram. Programming is implemented in Ladder Diagram. Furthermore, the software offers the opportunity for simulation, on-line communication and documentation.



easySoft-Pro

With easySoft-Pro, **easy500/700/800, the multi function display MFD-Titan, as well as easy800 with SmartWire-DT** can be programmed. In addition to the functions of the easySoft-Basic, a screen editor for creation of the MFD Titan screens is available with the easySoft-Pro. The integration of the SmartWire-DT line into the program occurred with the inclusion of the SmartWire-DT configurator. The easySoft-Pro CD contains a free OPC server, which enables the standardized inclusion of higher-level control systems (OPC clients). Just like easySoft-Basic, easySoft-Pro can be installed in 13 languages.

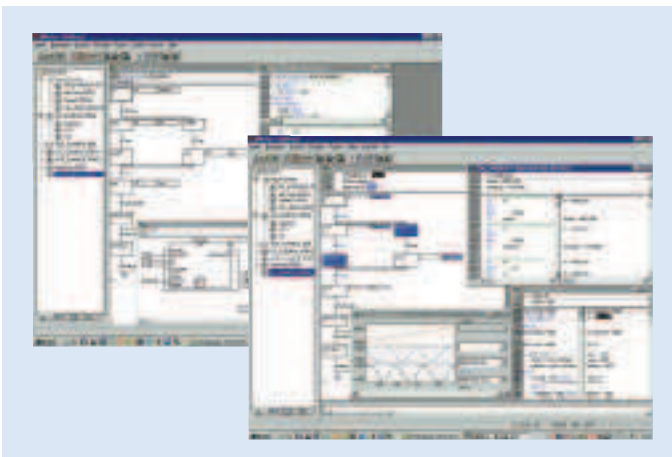

XSoft-CoDeSys-2

XSoft-CoDeSys-2 is the programming software for easyControl and the HMI-PLC. The software is based on standard CoDeSys from 3S for industrial PLCs in compliance with the international standard IEC 61131-3. The available programming languages are Instruction list (IL), Structured Text (ST), Function Block Diagram (FBD), Freely definable graphical function block chart/Continuous Function Chart (CFC), Ladder Diagram (LD) and Sequential Function Chart (SFC). The integrated online simulation facilitates program text even, when the control is not connected.



GALILEO

GALILEO is an easy-to-learn, and nevertheless powerful, visualization software. It is ideally suited for all machine and process-oriented applications in system and machine building. With its non-sector specific concept, GALILEO offers seamless project design for all **Eaton Touch Panels**. Simple placement of the objects by "Drag&Drop" and a clear menu guidance facilitate fast creation of a comfortable visualization system. This can be simulated directly on the development PC without connection to a HMI or a HMI-PLC.

Eaton is dedicated to ensuring that reliable, efficient and safe power is available when it's needed most. With unparalleled knowledge of electrical power management across industries, experts at Eaton deliver customized, integrated solutions to solve our customers' most critical challenges.

Our focus is on delivering the right solution for the application. But, decision makers demand more than just innovative products. They turn to Eaton for an unwavering commitment to personal support that makes customer success a top priority. For more information, **visit www.eaton.com/electrical**.

To contact an Eaton salesperson or local distributor/agent, please visit www.eaton.eu/electrical/customersupport

Changes to the products, to the information contained in this document, and to prices are reserved; so are errors and omissions. Only order confirmations and technical documentation by Eaton is binding. Photos and pictures also do not warrant a specific layout or functionality. Their use in whatever form is subject to prior approval by Eaton. The same applies to Trademarks (especially Eaton, Moeller, Cutler-Hammer). The Terms and Conditions of Eaton apply, as referenced on Eaton internet pages and Eaton order confirmations.

Eaton Industries GmbH
Hein-Moeller-Str. 7-11
D-53115 Bonn/Germany

© 2012 by Eaton Corporation
All rights reserved
Printed in Germany
Publication No.: BR05013001Z-EN
ip July 2013
Article No.: 167004



Eaton is a registered trademark of Eaton Corporation

All other trademarks are property of their respective owners.

SmartWire-DT™ is a trademark of Eaton Corporation.