

**DE1** variable speed starters  
**DS7** and **S801+/S811+** soft starters

**DC1, DA1, DG1** and **SVX/SPX** variable frequency drives  
**Rapid Link 4.0** distributed, electronic drive system



# Product Range Catalog

Efficient Engineering for  
Starting and Controlling Motors

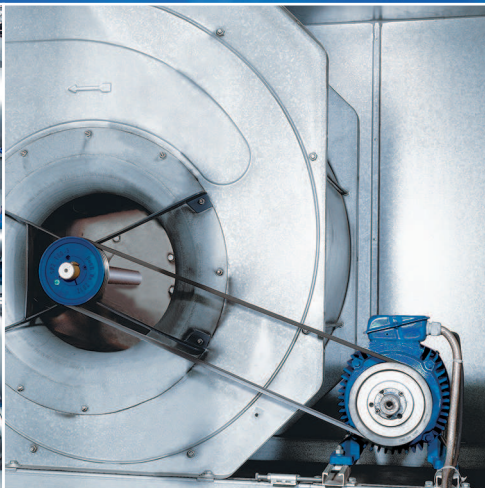

**EATON**

*Powering Business Worldwide*

# Eaton Online Catalog – find product details quickly and efficiently!

You can find comprehensive up-to-date product information at <http://ecat.moeller.net>

## Lookup

You can search by keywords, product names, article numbers, technical data: The search understands everything and takes you straight to the product you're looking for.

## Graphical navigation

Graphical representation of the fields of application and product groups.

## Selection aids

Tailored to the typical expert's approach, this search aid helps you quickly find the product you need.

## Data sheets

For every article the catalog can generate a technical data sheet, which you can convert to a PDF file for printing or saving with a single click.

## Parts lists

From your search results you can create a parts list that you can then send to your Eaton sales partner as a query.

You can find comprehensive up-to-date information about Eaton's automation products and switchgear in our Online Catalog.



HTML data sheet; can be saved as PDF file.



Parts list, e.g. for queries to Eaton Sales.



# Contents

Technical overview

Page 4

## PowerXL™ variable frequency drives



DE1 variable speed starter  
Drives Economy (VSS) Page 6

DC1 variable frequency drive  
Drives Compact Page 14

DA1 variable frequency drives  
Drives Advanced Page 28

DG1 variable frequency drives  
Drives General Purpose Page 42

Accessories and Engineering  
(reactor, sine filter, braking resistance) Page 52

## Variable frequency drive 9000X



SVX/SPX variable frequency drives  
(Standard-/variable frequency drives) Page 74

## Soft starters



DS7 soft starters  
(two-phase controlled) Page 96

Soft starter S801+/S811+  
(three-phase controlled) Page 116

## Rapid Link



Rapid Link 4.0 distributed, electronic drive  
system Page 126

## SmartWire-DT

SWD communication system  
(accessories) Page 144

## Appendix

Motor data, motor information  
(General Information, service) Page 150



# Energizing a world that demands more.

Discover today's Eaton.

## Powering business worldwide

As a global power management company, we help customers worldwide manage the power needed for buildings, aircraft, trucks, cars, machinery and businesses.

Eaton's innovative technologies help customers manage electrical, hydraulic and mechanical power more reliably, efficiently, safely and sustainably.

**EATON**

*Powering Business Worldwide*



## We deliver:

- **Electrical solutions** that use less energy, improve power reliability and make the places we live and work safer and more comfortable
- **Hydraulic and electrical solutions** that enable machines to deliver more productivity without wasting power
- **Aerospace solutions** that make aircraft lighter, safer and less costly to operate, and help airports operate more efficiently
- **Vehicle drivetrain and powertrain solutions** that deliver more power to cars, trucks and buses, while reducing fuel consumption and emissions

We provide integrated solutions that help make energy, in all its forms, more practical and accessible.

With 2014 sales of \$22.6 billion, Eaton has approximately 100,000 employees around the world and sells products in more than 175 countries.

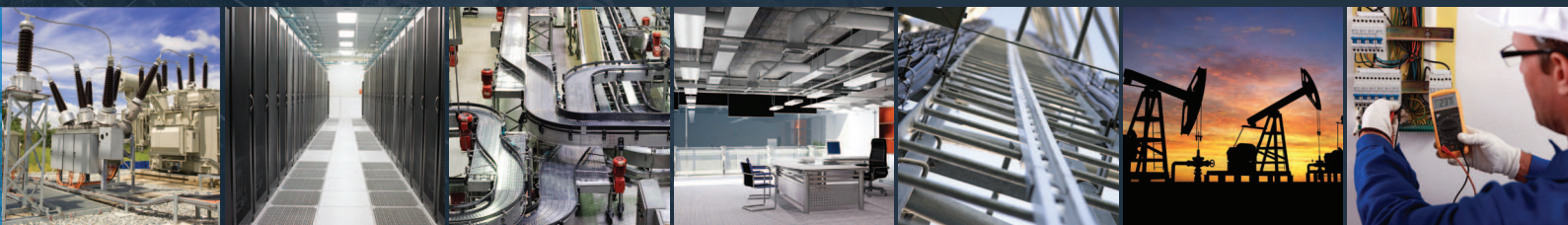

## Eaton's electrical business

### Eaton is a global leader with expertise in:

- Power distribution and circuit protection
- Backup power protection
- Solutions for harsh and hazardous environments
- Lighting and security
- Structural solutions and wiring devices
- Control and automation
- Engineering services

Eaton is positioned through its global solutions to answer today's most critical electrical power management challenges. With 100 years of electrical experience behind us, we're energized by the challenge of powering up a world that demands twice as much energy as today. We're anticipating needs, engineering products and creating solutions to energize our markets today and in the future.

We are dedicated to ensuring that reliable, efficient and safe power is available when it's needed most.

[Eaton.com](http://Eaton.com)

			PowerXL	
			DE1	DC1
<b>Mains voltage (50/60Hz)</b>				
$U_e = 115$ V AC, single-phase	$U_{LN}$	V	-	110 (-10%) - 115 (+10%)
$U_e = 230$ V AC, 1-phase	$U_{LN}$	V	200 (-10%) - 240 (+10%)	200 (-10%) - 240 (+10%)
$U_e = 230$ V AC, 3-phase	$U_{LN}$	V	-	200 (-10%) - 240 (+10%)
$U_e = 400$ V AC, 3-phase	$U_{LN}$	V	380 (-10%) - 480 (+10%)	380 (-10%) - 480 (+10%)
$U_e = 500$ V AC, 3-phase	$U_{LN}$	V	-	-
$U_e = 690$ V AC, 3-phase	$U_{LN}$	V	-	-
<b>Rated operational current</b>				
$U_2 = 115$ V AC, single-phase	$I_e$	A	-	7 - 10.5
$U_2 = 230$ V AC, single-phase	$I_e$	A	-	4.3 - 10.5
$U_2 = 230$ V AC, 3-phase	$I_e$	A	1.3 - 9.6	2.3 - 18
$U_2 = 400$ V AC, 3-phase	$I_e$	A	1.3 - 16	2.2 - 24
$U_2 = 500$ V AC, 3-phase	$I_e$	A	-	-
$U_2 = 690$ V AC, 3-phase	$I_e$	A	-	-
Overload current at $I_L$ (low overload)/Overload current at $I_H$ (High overload)	$I_L/I_H$	%	-/150	-/150
<b>Overload cycle for 60 s every 600 s</b>				
<b>max. starting current (High Overload)</b>				
for 2 seconds every 20 seconds		%	-	175
for 1.875 seconds every 600 seconds		%	200	-
for 4 seconds every 40 seconds		%	-	-
<b>Operation Mode</b>				
U/f control			✓	✓
Speed control with slip compensation			✓	✓
sensorless vector control (SLV)			-	-
optional: Vector control with feedback (CLV)			-	-
CT = Constant torque /VT = Variable torque			✓/-	✓/-
<b>Assigned motor rating</b>				
at 115 V, 50 Hz	P	kW	-	0.37 - 0.55
at 230 V, 50 Hz	P	kW	-	0.37 - 1.1
at 230 V, 50 Hz	P	kW	0.25 - 2.2	0.37 - 4
at 400 V, 50 Hz	P	kW	0.37 - 7.5	0.75 - 11
at 500 V, 50 Hz	P	kW	-	-
at 690 V, 50 Hz	P	kW	-	-
Output Frequency	$f_2$	Hz	0 - 50/60 (max. 300)	0 - 50/60 (max. 500)
Switching frequency	$f_{PWM}$	kHz	adjustable 4 - 32 (audible)	adjustable 4 - 32 (audible)
Degree of Protection			IP20/NEMA 0	IP20/NEMA 0, IP66/NEMA4X
<b>Ambient temperature at <math>I_L/I_H</math> (operation)</b>				
IP00	θ	°C	-	-
IP20/IP21	θ	°C	-10 - +50 (max. +60)	-10 - +50
IP54/IP55	θ	°C	-	-
IP66	θ	°C	-	-10 - +40
<b>Fitted with</b>				
Radio interference suppression filter			-/✓	-/✓
Brake chopper			-	-/✓
DC link choke			-	-
Additional PCB protection (coated board)			-	-
7-digital display assembly			-	✓
OLED display			-	-
Multi-line graphic display			-	-
<b>Safety function STO (Safe Torque Off)</b>				
<b>Interface/field bus (built-in)</b>				
OP-Bus (RS485)/Modbus RTU			✓	-
OP-Bus (RS485)/Modbus RTU, CANopen®			-	✓
Modbus RTU, Modbus TCP, BACnet MS/TP, Ethernet IP			-	-
<b>Fieldbus connection (optional)</b>				
			optional	optional
Connection to SmartWire-DT			optional	optional
Analog inputs			1 (0 - 10 V, 0/4 - 20 mA)	1/2 (0 - 10 V, 0/4 - 20 mA)
Analog outputs			-	-
Digital inputs (24 V)			3/4	3/4
Digital outputs (24 V)			-	-/1
Relay outputs			1 (N/O)	1 (N/O)
Standards			IEC/EN 61800-2, IEC/EN 61800-3, IEC/EN 61800-5	
Certifications			CE, UL, cUL, c-Tick	CE, cUL, UL, c-Tick, Ukr Sepro, EAC
Approvals			-	-

DA1	DL1	DG1	9000X SVX	SPX
-	-	-	-	-
200 (-10%) - 240 (+10%)	-	-	-	-
200 (-10%) - 240 (+10%)	-	208 (-15%) - 240 (+10%)	-	-
380 (-10%) - 480 (+10%)	380 (-10%) - 480 (+10%)	380 (-15%) - 480 (+10%)	380 (-15%) - 500 (+10%)	380 (-15%) - 500 (+10%)
500 (-10%) - 600 (+10%)	-	-	-	-
-	-	-	525 (-15%) - 690 (±10%)	525 (-15%) - 690 (±10%)
-	-	-	-	-
-	-	-	-	-
4.3 - 248	-	3.7 - 170	-	-
2.2 - 450	9.5 - 72	2.2 - 170	2.2 - 245	2.2 - 1940
2.1 - 150	-	-	-	-
-	-	-	3.2 - 170	3.2 - 1900
-/150	-/150	110/150	110/150	110/150
-	-	200	-	-
-	-	-	-	-
200	200	-	-	-
✓	✓	✓	✓	✓
✓	✓	✓	-	-
✓	✓	✓	✓	✓
✓	✓	✓	-	✓
✓/✓	✓/✓	✓ at I <sub>H</sub> /✓ at I <sub>L</sub>	✓ at I <sub>H</sub> /✓ at I <sub>L</sub>	✓ at I <sub>H</sub> /✓ at I <sub>L</sub>
-	-	-	-	-
-	-	-	-	-
0.75 - 75	-	0.75 - 45	-	-
0.75 - 250	4 - 37	0.75 - 90	0.75 - 132	0.75 - 900
1.1 - 90	-	-	-	-
-	-	-	2.2 - 160	2.2 - 1800
0 - 50/60 (max. 500) adjustable 4 - 32 (audible)	0 - 50/60 (max. 500) adjustable 4 - 32 (audible)	0 - 50/60 (max. 400) adjustable 1 - 12 (real)	0 - 50/60 (max. 320) adjustable 1 - 16 (real)	0 - 50/60 (max. 320) adjustable 1 - 16 (real)
IP20/NEMA 0, IP55, IP55/NEMA 3, IP66/NEMA4X	IP20/NEMA 0, IP55/NEMA 3	IP21, IP54	IP21, IP54	IP00, IP21, IP54
-	-	-	-	-10 - +40
-10 - +50	-10 - +50	-10 - +40/-10 - +50	-10 - +40/-10 - +50	-10 - +40/-10 - +50
-10 - +40	-10 - +40	-10 - +40/-10 - +50	-10 - +40/-10 - +50	-10 - +40/-10 - +50
-10 - +40	-	-	-	-
✓	✓	✓	✓	✓
-/✓	✓	✓	-/✓	-/✓
✓ (FS5 - FS7)	✓ (FS 5 - FS7)	✓	-/✓	-/✓
✓	-/✓	✓	-/Option	-/Option
✓	✓	-	-	-
✓	-	-	✓	✓
-	-	✓	-	-
✓	✓	✓	-	-
-	-	-	-	-
✓	✓	-	-	-
-	-	✓	-	-
Ethernet IP, DeviceNet, PROFIBUS, PROFINET, Modbus-TCP, EtherCAT, BACnet/IP	PROFIBUS	PROFIBUS	PROFIBUS-DP, LonWorks, CANopen®, DeviceNet, Modbus-TCP, BACnet/IP	
optional	optional	-	-	-
1/2 (0 - 10 V, 0/4 - 20 mA)	1/2 (0 - 10 V, 0/4 - 20 mA)	2 (0 - 10 V, 0/4 - 20 mA)	2 (0 - 10 V, 0/4 - 20 mA)	2 (0 - 10 V, 0/4 - 20 mA)
1/2 (0 - 10 V, 0/4 - 20 mA)	1/2 (0 - 10 V, 0/4 - 20 mA)	2 (0 - 10 V, 0/4 - 20 mA)	1 (0/4 - 20 mA)	1 (0/4 - 20 mA)
4/5	4/5	8	6	6
1/2	1/2	1	1	1
2 (1 x N/O, 1 x changeover contact)	2 (1 x N/O, 1 x changeover contact)	3 (2 x N/O, 1 x changeover contact)	2 (N/O)	2 (N/O)
IEC/EN 61800-2, IEC/EN 61800-3, IEC/EN 61800-5				
CE, cUL, UL, c-Tick, Ukr Sepr, EAC		CE, UL, cUL, c-Tick	CE, UL, cUL, c-Tick	CE, UL, cUL, c-Tick
DNV	-	-	DNV	DNV



# PowerXL™ DE1 Variable Speed Starters

The new PowerXL™ DE1 variable speed starter combines ease of use and maximum reliability with variable motor speeds and improved machine energy efficiency. This new category of devices is the first to close the gap between conventional motor starters and variable frequency drives and combine all the advantages in a single unit.

#### Performance range:

- 0.25 ... 2.2 kW ( $U_g$ : 1~ 230 V,  $U_2$ : 3~ 230 V)
- 0.37 ... 7.5 kW ( $U_g$ : 3~ 400 V,  $U_2$ : 3~ 400 V)

#### Features:

Compact: 45-mm width

Out-of-the-box commissioning without parameterization

- No special drives engineering skills or knowledge required
- Screwdriver parameterization can be set with an optional configuration module (DXE-EXT-SET)
- Trip-free-design ensures maximum machine availability
- Suitable for use in ambient temperatures of up to 60 °C
- International standards (CE, UL, cUL, cTick, RoHS)

#### Accessories:

##### • Plug-in configuration module

- SmartWire-DT connection
- External LED keypad
- Mains chokes
- Motor chokes
- Sine filters
- drivesConnect parameter configuration software
- Parameter Copy Stick
- External EMC filter

#### Applications:

- Fans, pumps
- Simple Machines
- Retrofits in machines and systems in order to replace conventional motor starters or contactors for motor control





System overview	8
Key to type references	9
Sizes and degree of protection	9
UL/CSA	9
Ordering	
Variable speed starter DE1	10
Accessories	11

DE1, frame size 1

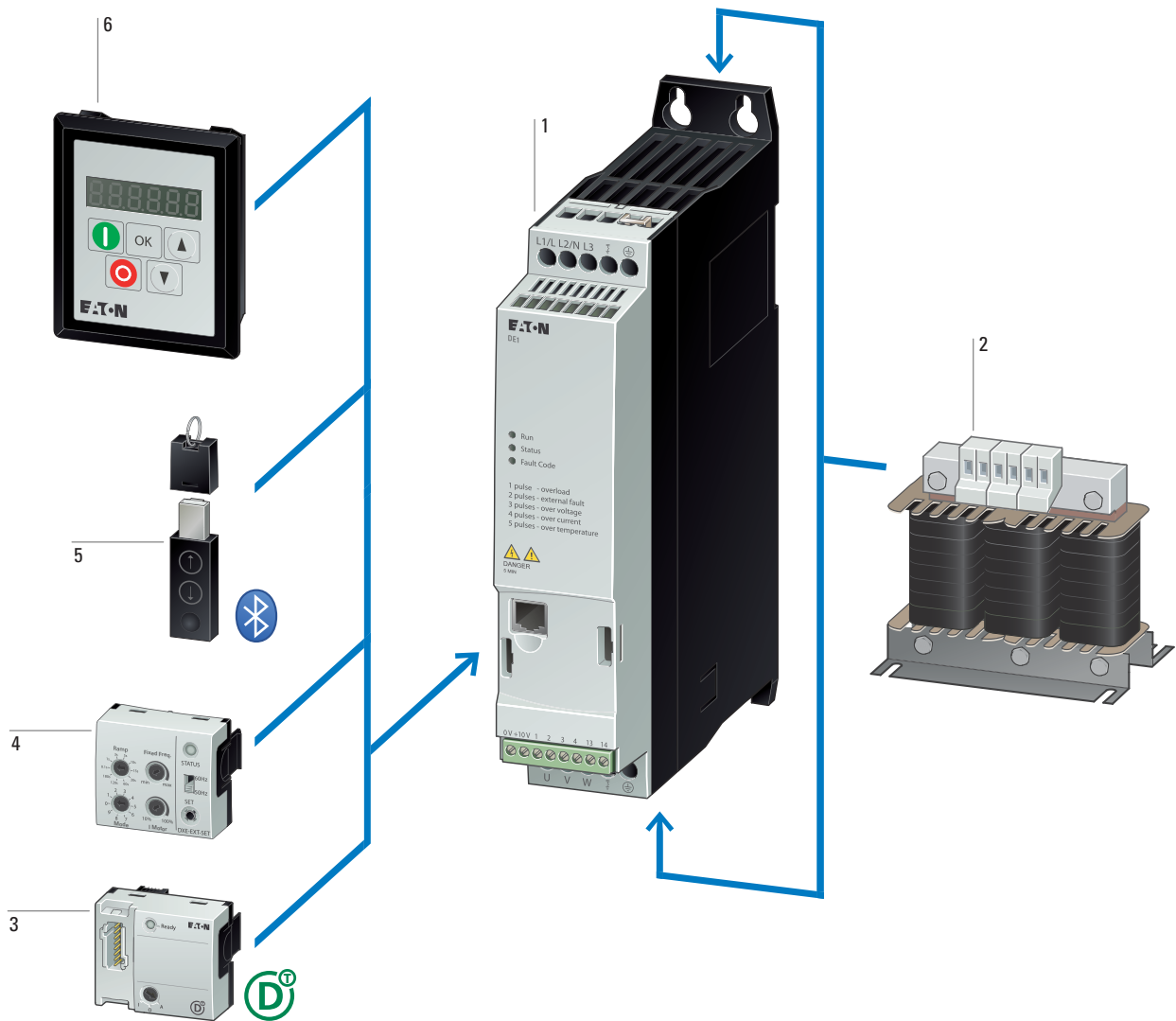

**DE1 variable speed starter** 1

→ page 10

**Mains choke, motor choke, sine filter** 2

→ page 60, → page 61

**SmartWire-DT module** 3

→ page 11

**Configuration module** 4

→ page 11

**Memory and Bluetooth communication stick** 5

→ page 11

**External keypad** 6

→ page 11

**Key to type references**

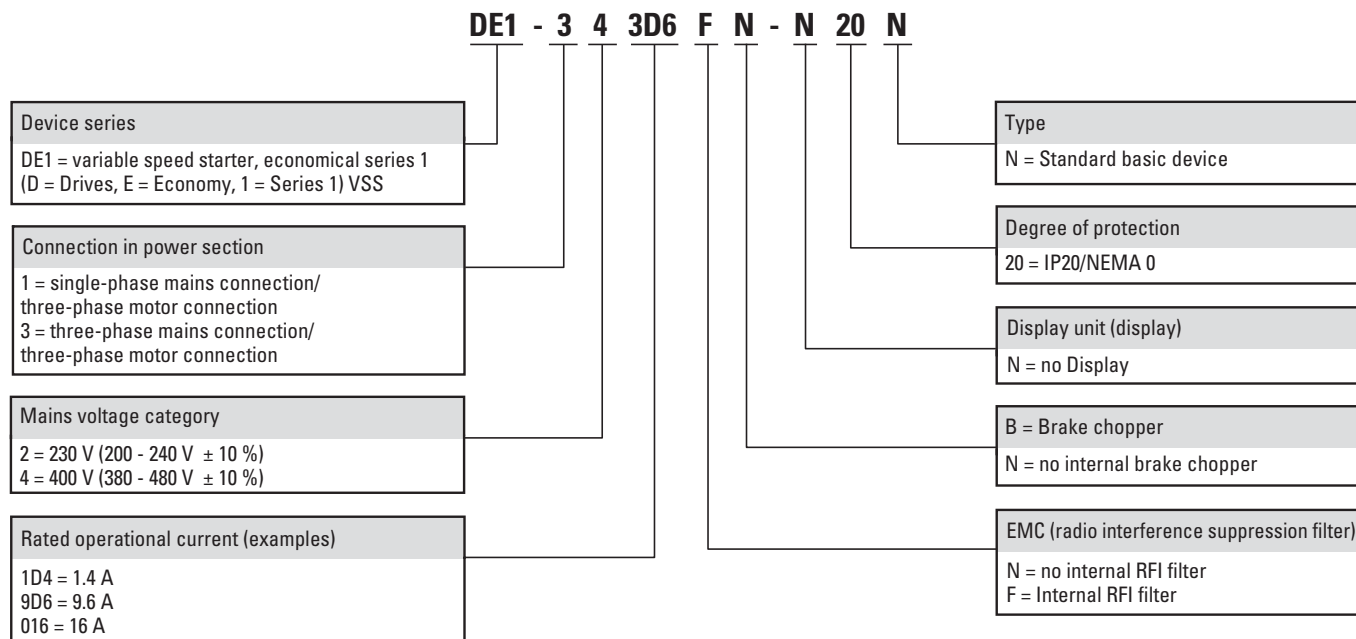

**Sizes and degree of protection**

Frame size	Degree of Protection IP20/NEMA 0
------------	-------------------------------------

FS1

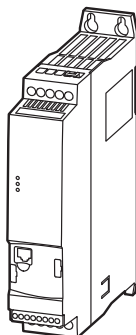

FS2

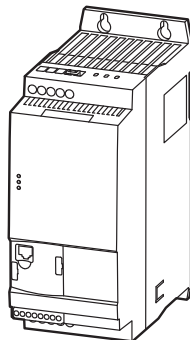





**UL/CSA**

**Information relevant for export to North America**



Product Standards	UL 508C; CSA-C22.2 No. 14; IEC/EN61800-3; IEC/EN61800-5; CE marking
UL File No.	E172143
UL Category Control No.	NMMS, NMMS7
CSA File No.	UL report applies to both US and Canada
North America Certification	UL listed, certified by UL for use in Canada
Suitable for	Branch circuits
Max. Voltage Rating	1~ 240 V AC IEC: TN-S UL/CSA: "Y" (Solidly Grounded Wey) 3~ 480 V AC IEC: TN-S UL/CSA: "Y" (Solidly Grounded Wey)
Degree of Protection	IEC: IP20

Rated operational current <sup>1), 2)</sup> $I_e$ A	Assigned motor rating <sup>2), 3), 4)</sup>		Radio interference suppression filter	Frame size	Degree of Protection	Part no. Article no.	Price see price list	Std. pack
	P kW	P HP						
<b>PowerXL™ DE1 Speed Starters</b>								
U <sub>e</sub> 230 V AC, 1-phase / U <sub>2</sub> 230 V AC, 3-phase Mains voltage (50/60Hz) U <sub>LN</sub> 200 (-10%) - 240 (+10%) V								
1.4	0.25	0.33	- ✓	FS1	IP20/NEMA 0	DE1-121D4NN-N20N 177359		1 off  
						DE1-121D4FN-N20N 174327		
2.3	0.37	0.5	- ✓			DE1-122D3NN-N20N 177360		
						DE1-122D3FN-N20N 174328		
2.7	0.55		- ✓			DE1-122D7NN-N20N 177361		
						DE1-122D7FN-N20N 174329		
4.3	0.75	1	- ✓	FS2	IP20/NEMA 0	DE1-124D3NN-N20N 177362		
						DE1-124D3FN-N20N 174330		
7	1.5	2	- ✓			DE1-127D0NN-N20N 177363		
						DE1-127D0FN-N20N 174331		
9.6	2.2	3	- ✓			DE1-129D6NN-N20N 177364		
						DE1-129D6FN-N20N 174332		
U <sub>e</sub> 400 V AC, 3-phase / U <sub>2</sub> 400 V AC, 3-phase Mains voltage (50/60Hz) U <sub>LN</sub> 380 (-10%) - 480 (+10%) V								
1.3	0.37	0.5	- ✓	FS1	IP20/NEMA 0	DE1-341D3NN-N20N 177365		1 off  
						DE1-341D3FN-N20N 174333		
2.1	0.75	1	- ✓			DE1-342D1NN-N20N 177366		
						DE1-342D1FN-N20N 174334		
3.6	1.5	2	- ✓			DE1-343D6NN-N20N 177367		
						DE1-343D6FN-N20N 174335		
5	2.2	3	- ✓	FS2	IP20/NEMA 0	DE1-345D0NN-N20N 177368		
						DE1-345D0FN-N20N 174336		
6.6	3		- ✓			DE1-346D6NN-N20N 177369		
						DE1-346D6FN-N20N 174337		
8.5	4	5	- ✓			DE1-348D5NN-N20N 177370		
						DE1-348D5FN-N20N 174338		
11.3	5.5	7.5	- ✓	FS2	IP20/NEMA 0	DE1-34011NN-N20N 177371		
						DE1-34011FN-N20N 174339		
16	7.5	10	- ✓			DE1-34016NN-N20N 177372		
				DE1-34016FN-N20N 174340				

**Notes**

<sup>1)</sup> Rated operational current at an operating frequency of 16 kHz and an ambient air temperature of +50 °C

<sup>2)</sup> Overload cycle: 150 % for 60 s every 600 s









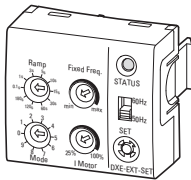

<sup>3)</sup> DE1-12...: at 230 V, 50 Hz/at 220 - 240 V, 60 Hz

DE1-34...: at 400 V, 50 Hz/at 440 - 480 V, 60 Hz

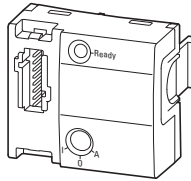
<sup>4)</sup> for normal internally and externally ventilated 4 pole, three-phase asynchronous motors with 1500 rpm<sup>-1</sup> at 50 Hz or 1800 min<sup>-1</sup> at 60 Hz



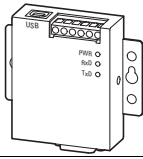

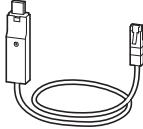



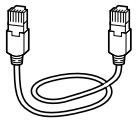

**Information relevant for export to North America → Page 9**

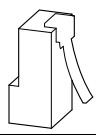
Description	Length	For use with	Part no. Article no.	Price see price list	Std. pack
<b>External keypad</b>					
 With 7-digit display assembly Front IP54 With approx. 3 m-long, plug-in connection cable (RJ45, 8-pin)	3	DE1, DC1, DA1, DL1	<b>DX-KEY-LED</b> 169132		1 off  
<b>Configuration module</b>					
<b>Plug-in module (front)</b>					
 With selector switch for ramp time and operating mode With potentiometer for motor protection and fixed frequency	-	DE1	<b>DXE-EXT-SET</b> 174621		1 off  
<b>SmartWire-DT Modules</b>					
 Plug-in module (front) with slot for SWD4-8SF2-5 external device plug	-	DE1, DC1 (IP20)	<b>DX-NET-SWD3</b> 169131		1 off  
<b>PC communication</b>					
<b>Parameter storage unit and Bluetooth communication stick</b>					
 For storage, copying parameters, and/or transferring parameters to a PC with the drivesConnect software via Bluetooth With 2 function keys for uploading and downloading parameters with configuration memory	-	DE1, DC1, DA1, DL1	<b>DX-COM-STICK</b> 169134		1 off
<b>Interface converter</b> For directly connecting the variable-frequency drive to a computer with drivesConnect software					
 Interface converter USB/RS485 with connection cable, RJ45, 8 pole electrically isolated 1 x SUB-D plug, 9-pole Terminal strip, 5-terminal Status-LED	-	DE1, DC1, DA1, DL1	<b>DX-COM-PCKIT</b> 169135		1 off  
 Interface converter USB/RS485 with connection cable, RJ45, 8 pole electrically isolated	-	DE1, DC1, DA1, DL1	<b>DX-CBL-PC-1M5</b> 171018		1 off

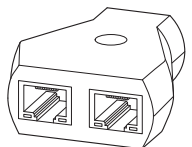
  **Information relevant for export to North America**

Product Standards	UL 508C; CSA-C22.2 No. 14; IEC/EN61800-3; IEC/EN61800-5; CE marking DXE-EXT-SET: UL 508C; CSA-C22.2 No. 274; IEC/EN61800-3; IEC/EN61800-5; CE marking
UL File No.	E172143
UL Category Control No.	NMMS, NMMS7
CSA File No.	UL report applies to both US and Canada
North America Certification Suitable for	UL listed, certified by UL for use in Canada Branch circuits

Description	Length	For use with	Part no. Article no.	Price see price list	Std. pack
<b>PC communication</b>					
<b>Connecting cable</b>					
	Patch cord with RJ45 plugs, 8 pole	0.5	DE1, DC1, DA1, DL1	<b>DX-CBL-RJ45-0M5</b> 169137	1 off  
		1		<b>DX-CBL-RJ45-1M0</b> 169138	
		3		<b>DX-CBL-RJ45-3M0</b> 169139	
<b>Bus terminating resistor</b>					
	RJ45 8 pole Connection to CANopen® (pin 1/2, 124 Ω) or to Modbus RTU (pin 7/8, 120 Ω)	-	easyNet DX-SPL-RJ45-2SL-1PL	<b>EASY-NT-R</b> 256281	2 off  
<b>Splitter</b>					
	RJ45, 8-pin, 3 sockets	-	DX-CBL-RJ45...	<b>DX-SPL-RJ45-3SL</b> 169141	1 off  
	RJ45, 8-pin, 2 sockets/1 plug	-	DX-CBL-RJ45...	<b>DX-SPL-RJ45-2SL1PL</b> 169142	1 off  

**Information relevant for export to North America**

Product Standards	UL 508C; CSA-C22.2 No. 14; IEC/EN61800-3; IEC/EN61800-5; CE marking DXE-EXT-SET: UL 508C; CSA-C22.2 No. 274; IEC/EN61800-3; IEC/EN61800-5; CE marking
UL File No.	E172143
UL Category Control No.	NMMS, NMMS7
CSA File No.	UL report applies to both US and Canada
North America Certification	UL listed, certified by UL for use in Canada
Suitable for	Branch circuits

**EASY-NT-R:**

Product Standards	IEC/EN see Technical Data; UL 508; CSA C22.2 No. 142-M1987; CSA C22.2 No. 213-M1987; CE marking
UL File No.	E135462
UL Category Control No.	NRAQ
CSA File No.	012528
CSA Class No.	2258-02
North America Certification	UL listed, CSA certified
Degree of Protection	IEC: IP20, UL/CSA Type: -





# PowerXL™ Variable Frequency Drives DC1 Compact Machinery Drive

The compact PowerXL™ DC1 variable frequency drive is particularly well-suited for use with simple pump, fan, and conveyor belt systems. It can be quickly and easily configured and commissioned, resulting in tangible savings.

#### Performance range:

- 0.37 ... 0.55 kW ( $U_{\theta}$ : 1~ 115 V,  $U_2$ : 1~ 115 V)
- 0.37 ... 1.1 kW ( $U_{\theta}$ : 1~ 115 V,  $U_2$ : 3~ 230 V)
- 0.37 ... 1.1 kW ( $U_{\theta}$ : 1~ 230 V,  $U_2$ : 1~ 230 V)
- 0.37 ... 4 kW ( $U_{\theta}$ : 1~ 230 V,  $U_2$ : 3~ 230 V)
- 0.37 ... 4 kW ( $U_{\theta}$ : 3~ 230 V,  $U_2$ : 3~ 230 V)
- 0.75 ... 11 kW ( $U_{\theta}$ : 3~ 400 V,  $U_2$ : 3~ 400 V)

#### Features:

- Fast commissioning with 14 basic parameters
- Large overload capability: 150% for 60 seconds, 175% for 2 seconds
- Ambient air temperature up to 50 °C without derating
- Integrated CANopen and Modbus RTU
- Degrees of protection IP20 and IP66
- Integrated EMC filter
- Integrated braking transistor
- Integrated PI controller
- V/F control
- Voltage boost
- DC braking
- Detachable control signal terminal strip
- International standards (CE, UL, cUL, c-Tick, RoHS, Gost-R, UkrSEPRO)

#### Accessories:

- SmartWire-DT connection
- I/O expansions
- External keypad
- Mains chokes
- Motor chokes
- Sine filters
- Braking resistances
- drivesConnect parameter configuration software
- External EMC filter

#### Applications:

- Pumps, fans
- Machines
- Coating systems
- Conveyor belts
- Filling machines
- Distributed applications (IP66)
- Applications with single-phase motors





System overview	16
Key to type references	17
Sizes and degree of protection	17
UL/CSA	17
Ordering	
Variable frequency drives DC1, IP20	18
Variable frequency drives DC1, IP66	22
Accessories	26

System overview

DC1 with IP20 degree of protection

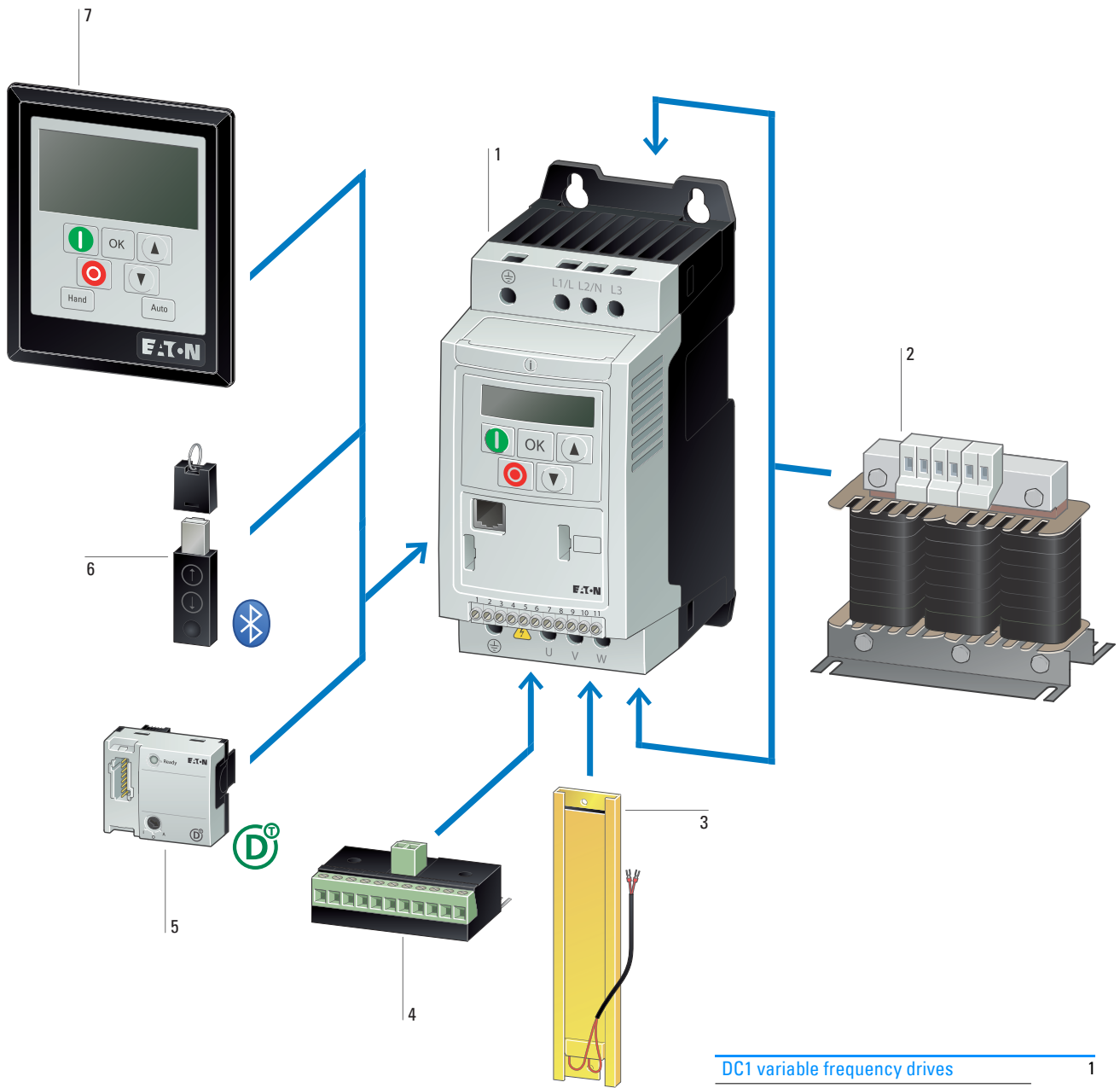

DC1 variable frequency drives	1
→ page 18	
Mains choke, motor choke, sine filter	2
→ page 60, → page 61	
Braking resistance	3
→ page 56	
Expansion modules	4
→ page 26	
SmartWire-DT module	5
→ page 26	
Memory and Bluetooth communication stick	6
→ page 26	
External keypad	7
→ page 26	

Key to type references

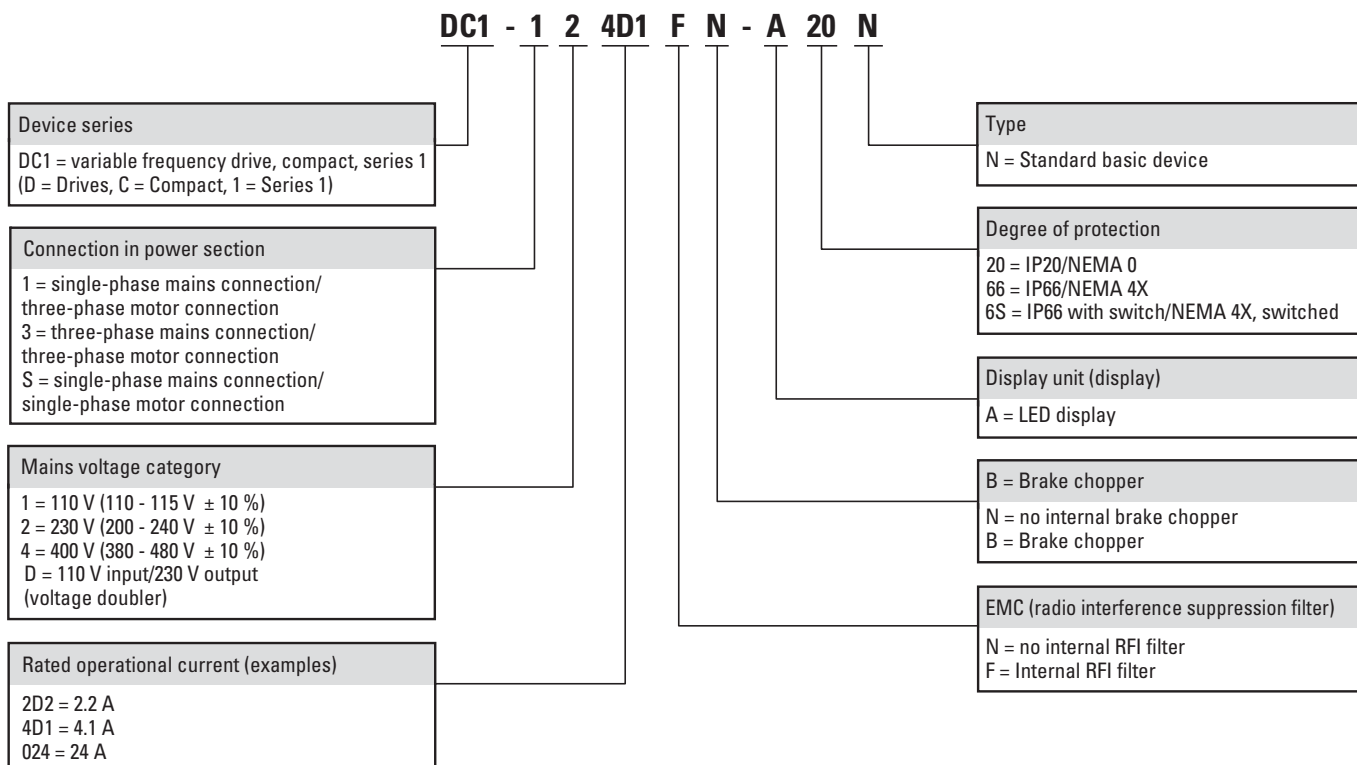

DC1

Sizes and degree of protection



Frame size	Degree of Protection		
	IP20/NEMA 0	IP66/NEMA 4X	IP66/NEMA 4X Local controls
FS1			
FS2			
FS3			
FS4			

UL/CSA

Information relevant for export to North America



Product Standards	UL 508C; CSA-C22.2 No. 14; IEC/EN61800-3; IEC/EN61800-5; CE marking
UL File No.	E172143
UL Category Control No.	NMMS, NMMS7
CSA File No.	UL report applies to both US and Canada
North America Certification	UL listed, certified by UL for use in Canada
Suitable for	Branch circuits
Max. Voltage Rating	1~ 120 V AC IEC: TN-S UL/CSA: "Y" (Solidly Grounded Wey) 1~ 240 V AC IEC: TN-S UL/CSA: "Y" (Solidly Grounded Wey) 3~ 240 V AC IEC: TN-S UL/CSA: "Y" (Solidly Grounded Wey) 3~ 480 V AC IEC: TN-S UL/CSA: "Y" (Solidly Grounded Wey)

Rated operational current <sup>1), 4)</sup>	Assigned motor rating <sup>1), 2), 3)</sup>		Fitted with	Frame size	Degree of Protection	Part no. Article no.	Price see price list	Std. pack
$I_e$ A	P kW	P HP	Radio interference suppression filter Brake chopper 7-digital display assembly					
<b>PowerXL™ DC1 variable frequency drives</b>								
U <sub>e</sub> 115 V AC, single-phase / U <sub>2</sub> 115 V AC, single-phase Mains voltage (50/60Hz) U <sub>LN</sub> 110 (-10%) - 115 (+10%) V								
7	0.37	0.5	- - ✓	FS1	IP20/NEMA 0	<b>DC1-S17D0NN-A20N</b> 169497		1 off
10.5	0.55	0.75	- ✓ ✓	FS2		<b>DC1-S1011NB-A20N</b> 169500		
U <sub>e</sub> 230 V AC, 1-phase / U <sub>2</sub> 230 V AC, single-phase Mains voltage (50/60Hz) U <sub>LN</sub> 200 (-10%) - 240 (+10%) V								
4.3	0.37	0.5	- - ✓ ✓ - ✓	FS1	IP20/NEMA 0	<b>DC1-S24D3NN-A20N</b> 169512		1 off  
7	0.75	1	- - ✓ ✓ - ✓			<b>DC1-S24D3FN-A20N</b> 169521		
10.5	1.1	1.5	- ✓ ✓	FS2	<b>DC1-S27D0NN-A20N</b> 169515			
			✓ ✓ ✓		<b>DC1-S27D0FN-A20N</b> 169524			
						<b>DC1-S2011NB-A20N</b> 169518		
						<b>DC1-S2011FB-A20N</b> 169527		

**Notes**

<sup>1)</sup> Overload cycle: 150 % for 60 s every 600 s

<sup>2)</sup> DC1-S1...: at 115 V, 50 Hz/at 110 - 120 V, 60 Hz





DE1-34...:DC1-S2...: at 230 V, 50 Hz/at 220 - 240 V, 60 Hz

<sup>3)</sup> For AC motors with internal and external ventilation with 50/60 Hz without additional start capacitor

<sup>4)</sup> Rated operational current at an operating frequency of 16 kHz and an ambient air temperature of +50 °C









**Information relevant for export to North America → Page 17**

Rated operational current <sup>1), 4)</sup> <i>I<sub>e</sub></i> A	Assigned motor rating <sup>1), 2), 3)</sup> P kW	P HP	Fitted with Radio interference suppression filter Brake chopper 7-digital display assembly	Frame size	Degree of Protection	Part no. Article no.	Price see price list	Std. pack
<b>PowerXL™ DC1 variable frequency drives</b>								
U <sub>e</sub> 115 V AC, single-phase / U <sub>2</sub> 230 V AC, 3-phase The mains voltage of 115 V is raised to 230 V (output voltage) through an internal voltage double connection. Mains voltage (50/60Hz) U <sub>LN</sub> 110 (-10%) - 115 (+10%) V								
2.3	0.37	0.5	- - ✓	FS1	IP20/NEMA 0	<b>DC1-1D2D3NN-A20N</b> 169503		1 off  
4.3	0.75	1	- - ✓			<b>DC1-1D4D3NN-A20N</b> 169506		
5.8	1.1	1.5	- ✓ ✓	FS2		<b>DC1-1D5D8NB-A20N</b> 169509		
U <sub>e</sub> 230 V AC, 1-phase / U <sub>2</sub> 230 V AC, 3-phase Mains voltage (50/60Hz) U <sub>LN</sub> 200 (-10%) - 240 (+10%) V								
2.3	0.37	0.5	- - ✓ ✓ - ✓	FS1	IP20/NEMA 0	<b>DC1-122D3NN-A20N</b> 169222		1 off  
4.3	0.75	1	- - ✓ ✓ - ✓			<b>DC1-122D3FN-A20N</b> 169240		
7	1.5	2	- - ✓ ✓ - ✓ - ✓ ✓	FS2		<b>DC1-124D3NN-A20N</b> 169225		
						<b>DC1-124D3FN-A20N</b> 169243		
						<b>DC1-127D0NN-A20N</b> 169228		
						<b>DC1-127D0FN-A20N</b> 169246		
						<b>DC1-127D0NB-A20N</b> 169231		
						<b>DC1-127D0FB-A20N</b> 169249		
10.5	2.2	3	- ✓ ✓ ✓ ✓ ✓			<b>DC1-12011NB-A20N</b> 169234		
						<b>DC1-12011FB-A20N</b> 169252		
15 <sup>5)</sup>	4	5	- ✓ ✓	FS3		<b>DC1-12015NB-A20N</b> 169237		

**Notes**



- 1) Overload cycle: 150 % for 60 s every 600 s
- 2) at 230 V, 50 Hz/at 220 - 240 V, 60 Hz
- 3) for normal internally and externally ventilated 4 pole, three-phase asynchronous motors with 1500 rpm<sup>-1</sup> at 50 Hz or 1800 min<sup>-1</sup> at 60 Hz
- 4) Rated operational current at an operating frequency of 16 kHz and an ambient air temperature of +50 °C
- 5) Rated operational current at a switching frequency of 8 kHz and an ambient air temperature of +50 °C

  **Information relevant for export to North America → Page 17**

Rated operational current <sup>1), 4)</sup>		Assigned motor rating <sup>1), 2), 3)</sup>		Fitted with	Frame size	Degree of Protection	Part no. Article no.	Price see price list	Std. pack
I <sub>e</sub> A		P kW	P HP	Radio interference suppression filter Brake chopper 7-digital display assembly					
<b>PowerXL™ DC1 variable frequency drives</b>									
U <sub>e</sub> 230 V AC, 3-phase / U <sub>2</sub> 230 V AC, 3-phase Mains voltage (50/60Hz) U <sub>LN</sub> 200 (-10%) - 240 (+10%) V									
2.3		0.37	0.5	- - ✓	FS1	IP20/NEMA 0	<b>DC1-322D3NN-A20N</b> 169255		1 off  
4.3		0.75	1	- - ✓			<b>DC1-324D3NN-A20N</b> 169258		
7		1.5	2	- - ✓	FS2		<b>DC1-327D0NN-A20N</b> 169261		
				- ✓ ✓			<b>DC1-327D0NB-A20N</b> 169264		
				✓ ✓ ✓			<b>DC1-327D0FB-A20N</b> 169444		
10.5		2.2	3	- ✓ ✓	FS3		<b>DC1-32011NB-A20N</b> 169438		
				✓ ✓ ✓			<b>DC1-32011FB-A20N</b> 169447		
18		4	5	- ✓ ✓	FS3		<b>DC1-32018NB-A20N</b> 169441		
				✓ ✓ ✓			<b>DC1-32018FB-A20N</b> 169450		
24		5.5	7.5	- ✓ ✓	FS4		<b>DC1-32024NB-A20N</b> 180458		
				✓ ✓ ✓			<b>DC1-32024FB-A20N</b> 180455		
30		7.5	10	- ✓ ✓	FS4		<b>DC1-32030NB-A20N</b> 180459		
				✓ ✓ ✓			<b>DC1-32030FB-A20N</b> 180456		
46		11	15	- ✓ ✓	FS4		<b>DC1-32046NB-A20N</b> 180460		
				✓ ✓ ✓			<b>DC1-32046FB-A20N</b> 180457		
U <sub>e</sub> 400 V AC, 3-phase / U <sub>2</sub> 400 V AC, 3-phase Mains voltage (50/60Hz) U <sub>LN</sub> 380 (-10%) - 480 (+10%) V									
2.2		0.75	1	- - ✓	FS1	IP20/NEMA 0	<b>DC1-342D2NN-A20N</b> 169453		1 off  
				✓ - ✓			<b>DC1-342D2FN-A20N</b> 169475		
4.1		1.5	2	- - ✓	FS2		<b>DC1-344D1NN-A20N</b> 169456		
				✓ - ✓			<b>DC1-344D1FN-A20N</b> 169478		
				- ✓ ✓			<b>DC1-344D1NB-A20N</b> 169459		
				✓ ✓ ✓			<b>DC1-344D1FB-A20N</b> 169481		
5.8		2.2	3	- ✓ ✓	FS2		<b>DC1-345D8NB-A20N</b> 169462		
				✓ ✓ ✓			<b>DC1-345D8FB-A20N</b> 169484		
9.5		4	5	- ✓ ✓	FS2		<b>DC1-349D5NB-A20N</b> 169465		
				✓ ✓ ✓			<b>DC1-349D5FB-A20N</b> 169487		





**Notes**

- <sup>1)</sup> Overload cycle: 150 % for 60 s every 600 s
- <sup>2)</sup> DC1-32...: at 230 V, 50 Hz/at 220 - 240 V, 60 Hz  
DC1-34...: at 400 V, 50 Hz/at 440 - 480 V, 60 Hz
- <sup>3)</sup> for normal internally and externally ventilated 4 pole, three-phase asynchronous motors with 1500 rpm<sup>-1</sup> at 50 Hz or 1800 min<sup>-1</sup> at 60 Hz
- <sup>4)</sup> Rated operational current at an operating frequency of 16 kHz and an ambient air temperature of +50 °C
- <sup>5)</sup> Rated operational current at a switching frequency of 8 kHz and an ambient air temperature of +50 °C

Rated operational current <sup>1), 4)</sup>	Assigned motor rating <sup>1), 2), 3)</sup>		Fitted with	Frame size	Degree of Protection	Part no. Article no.	Price see price list	Std. pack
$I_e$ A	P kW	P HP	Radio interference suppression filter Brake chopper 7-digital display assembly					
<b>PowerXL™ DC1 variable frequency drives</b>								
U <sub>0</sub> 400 V AC, 3-phase / U <sub>2</sub> 400 V AC, 3-phase Mains voltage (50/60Hz) U <sub>LN</sub> 380 (-10%) - 480 (+10%) V								
14 <sup>4)</sup>	5.5	10	- ✓ ✓ ✓ ✓ ✓	FS3	IP20/NEMA 0	<b>DC1-34014NB-A20N</b> 169468		1 off  
18 <sup>4)</sup>	7.5		- ✓ ✓ ✓ ✓ ✓			<b>DC1-34014FB-A20N</b> 169490		
						<b>DC1-34018NB-A20N</b> 169471		
						<b>DC1-34018FB-A20N</b> 169493		
24 <sup>4)</sup>	11	15	- ✓ ✓ ✓ ✓ ✓			<b>DC1-34024NB-A20N</b> 169474		
						<b>DC1-34024FB-A20N</b> 169496		
30	15	20	- ✓ ✓ ✓ ✓ ✓	FS4		<b>DC1-34030NB-A20N</b> 180464		
						<b>DC1-34030FB-A20N</b> 180461		
39	18.5	25	- ✓ ✓ ✓ ✓ ✓			<b>DC1-34039NB-A20N</b> 180465		
						<b>DC1-34039FB-A20N</b> 180462		
46	22	30	- ✓ ✓ ✓ ✓ ✓			<b>DC1-34046NB-A20N</b> 180466		
						<b>DC1-34046FB-A20N</b> 180463		

**Notes**

- <sup>1)</sup> Overload cycle: 150 % for 60 s every 600 s
- <sup>2)</sup> DC1-34...: at 400 V, 50 Hz/at 440 - 480 V, 60 Hz
- <sup>3)</sup> for normal internally and externally ventilated 4 pole, three-phase asynchronous motors with 1500 rpm<sup>-1</sup> at 50 Hz or 1800 min<sup>-1</sup> at 60 Hz
- <sup>4)</sup> Rated operational current at a switching frequency of 8 kHz and an ambient air temperature of +50 °C





Rated operational current <sup>1), 4)</sup>	Assigned motor rating <sup>1), 2), 3)</sup>		Fitted with				Frame size	Degree of Protection	Part no. Article no.	Price see price list	Std. pack
	I <sub>e</sub> A	P kW	P HP	Radio interference	Brake chopper	7-digital display assembly					
<b>PowerXL™ DC1 variable frequency drives</b>											
U <sub>e</sub> 115 V AC, single-phase / U <sub>2</sub> 115 V AC, single-phase Mains voltage (50/60Hz) U <sub>LN</sub> 110 (-10%) - 115 (+10%) V											
7	0.37	0.5	-	-	✓	-	FS1	IP66/NEMA 4X	DC1-S17D0NN-A66N 169498		1 off  
			-	-	✓	✓			DC1-S17D0NN-A6SN 169499		
10.5	0.55	0.75	-	✓	✓	-	FS2	IP66/NEMA 4X	DC1-S1011NB-A66N 169501		
			-	✓	✓	✓			DC1-S1011NB-A6SN 169502		
U <sub>e</sub> 230 V AC, 1-phase / U <sub>2</sub> 230 V AC, single-phase Mains voltage (50/60Hz) U <sub>LN</sub> 200 (-10%) - 240 (+10%) V											
4.3	0.37	0.5	-	-	✓	-	FS1	IP66/NEMA 4X	DC1-S24D3NN-A66N 169513		1 off  
			-	-	✓	✓			DC1-S24D3NN-A6SN 169514		
			✓	-	✓	-			DC1-S24D3FN-A66N 169522		
			✓	-	✓	✓			DC1-S24D3FN-A6SN 169523		
7	0.75	1	-	-	✓	-	FS1	IP66/NEMA 4X	DC1-S27D0NN-A66N 169516		
			-	-	✓	✓			DC1-S27D0NN-A6SN 169517		
			✓	-	✓	-			DC1-S27D0FN-A66N 169525		
			✓	-	✓	✓			DC1-S27D0FN-A6SN 169526		
10.5	1.1	1.5	-	✓	✓	-	FS2	IP66/NEMA 4X	DC1-S2011NB-A66N 169519		
			-	✓	✓	✓			DC1-S2011NB-A6SN 169520		
			✓	✓	✓	-			DC1-S2011FB-A66N 169528		
			✓	✓	✓	✓			DC1-S2011FB-A6SN 169529		

**Notes**

- 1) Overload cycle: 150 % for 60 s every 600 s
- 2) DC1-S1...: at 115 V, 50 Hz/at 110 - 120 V, 60 Hz  
DE1-34...:DC1-S2...: at 230 V, 50 Hz/at 220 - 240 V, 60 Hz
- 3) For AC motors with internal and external ventilation with 50/60 Hz without additional start capacitor
- 4) Rated operational current at a switching frequency of 16 kHz and an ambient air temperature of +40 °C



  **Information relevant for export to North America → Page 17**



Rated operational current <sup>1), 4)</sup> <i>I<sub>e</sub></i> A	Assigned motor rating <sup>1), 2), 3)</sup>		Fitted with  Radio interference Brake chopper 7-digital display assembly Local controls	Frame size	Degree of Protection	Part no. Article no.	Price see price list	Std. pack
	P kW	P HP						
<b>PowerXL™ DC1 variable frequency drives</b>								
U <sub>e</sub> 115 V AC, single-phase / U <sub>2</sub> 230 V AC, 3-phase The mains voltage of 115 V is raised to 230 V (output voltage) through an internal voltage double connection. Mains voltage (50/60Hz) U <sub>LN</sub> 110 (-10%) - 115 (+10%) V								
2.3	0.37	0.5	- - ✓ - - - ✓ ✓	FS1	IP66/NEMA 4X	DC1-1D2D3NN-A66N 169504		1 off  
			- - ✓ ✓			DC1-1D2D3NN-A6SN 169505		
4.3	0.75	1	- - ✓ - - - ✓ ✓	FS1	IP66/NEMA 4X	DC1-1D4D3NN-A66N 169507		
			- - ✓ ✓			DC1-1D4D3NN-A6SN 169508		
5.8	1.1	1.5	- ✓ ✓ - - ✓ ✓ ✓	FS2	IP66/NEMA 4X	DC1-1D5D8NB-A66N 169510		
			- ✓ ✓ ✓			DC1-1D5D8NB-A6SN 169511		
U <sub>e</sub> 230 V AC, 1-phase / U <sub>2</sub> 230 V AC, 3-phase Mains voltage (50/60Hz) U <sub>LN</sub> 200 (-10%) - 240 (+10%) V								
2.3	0.37	0.5	- - ✓ - - - ✓ ✓ ✓ - ✓ - ✓ - ✓ ✓	FS1	IP66/NEMA 4X	DC1-122D3NN-A66N 169223		1 off  
			- - ✓ - - - ✓ ✓			DC1-122D3NN-A6SN 169224		
			✓ - ✓ - ✓ - ✓ ✓			DC1-122D3FN-A66N 169241		
			✓ - ✓ ✓			DC1-122D3FN-A6SN 169242		
4.3	0.75	1	- - ✓ - - - ✓ ✓ ✓ - ✓ - ✓ - ✓ ✓	FS1	IP66/NEMA 4X	DC1-124D3NN-A66N 169226		
			- - ✓ - - - ✓ ✓			DC1-124D3NN-A6SN 169227		
			✓ - ✓ - ✓ - ✓ ✓			DC1-124D3FN-A66N 169244		
			✓ - ✓ ✓			DC1-124D3FN-A6SN 169245		
7	1.5	2	- - ✓ - - - ✓ ✓ ✓ - ✓ - ✓ - ✓ ✓ - ✓ ✓ - - ✓ ✓ ✓ ✓ ✓ ✓ - ✓ ✓ ✓ ✓	FS2	IP66/NEMA 4X	DC1-127D0NN-A66N 169229		
			- - ✓ - - - ✓ ✓			DC1-127D0NN-A6SN 169230		
			✓ - ✓ - ✓ - ✓ ✓			DC1-127D0FN-A66N 169247		
			✓ - ✓ ✓			DC1-127D0FN-A6SN 169248		
			- ✓ ✓ - - ✓ ✓ ✓			DC1-127D0NB-A66N 169232		
			- ✓ ✓ ✓			DC1-127D0NB-A6SN 169233		
			✓ ✓ ✓ - ✓ ✓ ✓ ✓			DC1-127D0FB-A66N 169250		
			✓ ✓ ✓ ✓			DC1-127D0FB-A6SN 169251		
10.5	2.2	3	- ✓ ✓ - - ✓ ✓ ✓ ✓ ✓ ✓ - ✓ ✓ ✓ ✓	FS3	IP66/NEMA 4X	DC1-12011NB-A66N 169235		
			- ✓ ✓ - - ✓ ✓ ✓			DC1-12011NB-A6SN 169236		
			✓ ✓ ✓ - ✓ ✓ ✓ ✓			DC1-12011FB-A66N 169253		
			✓ ✓ ✓ ✓			DC1-12011FB-A6SN 169254		
15 <sup>5)</sup>	4	5	- ✓ ✓ - - ✓ ✓ ✓	FS3	IP66/NEMA 4X	DC1-12015NB-A66N 169238		
			- ✓ ✓ - - ✓ ✓ ✓			DC1-12015NB-A6SN 169239		

Notes

- 1) Overload cycle: 150 % for 60 s every 600 s
- 2) at 230 V, 50 Hz/at 220 - 240 V, 60 Hz
- 3) for normal internally and externally ventilated 4 pole, three-phase asynchronous motors with 1500 rpm<sup>-1</sup> at 50 Hz or 1800 min<sup>-1</sup> at 60 Hz
- 4) Rated operational current at a switching frequency of 16 kHz and an ambient air temperature of +40 °C
- 5) Rated operational current at a switching frequency of 8 kHz and an ambient air temperature of +40 °C



  Information relevant for export to North America → Page 17

Rated operational current <sup>1), 4)</sup>	Assigned motor rating <sup>1), 2), 3)</sup>		Fitted with				Frame size	Degree of Protection	Part no. Article no.	Price see price list	Std. pack	
	I <sub>e</sub> A	P kW	P HP	Radio interference	Brake chopper	7-digital display assembly						Local controls
<b>PowerXL™ DC1 variable frequency drives</b> U <sub>e</sub> 230 V AC, 3-phase / U <sub>2</sub> 230 V AC, 3-phase Mains voltage (50/60Hz) U <sub>LN</sub> 200 (-10%) - 240 (+10%) V												
2.3	0.37	0.5	-	-	✓	-	FS1	IP66/NEMA 4X	DC1-322D3NN-A66N 169256		1 off 	
			-	-	✓	✓			DC1-322D3NN-A66SN 169257			
4.3	0.75	1	-	-	✓	-	FS1	IP66/NEMA 4X	DC1-324D3NN-A66N 169259			
			-	-	✓	✓			DC1-324D3NN-A66SN 169260			
7	1.5	2	-	-	✓	-	FS1	IP66/NEMA 4X	DC1-327D0NN-A66N 169262			
			-	-	✓	✓			DC1-327D0NN-A66SN 169263			
			-	✓	✓	-	FS2	IP66/NEMA 4X	DC1-327D0NB-A66N 169436			
			-	✓	✓	✓			DC1-327D0NB-A66SN 169437			
			✓	✓	✓	-	FS2	IP66/NEMA 4X	DC1-327D0FB-A66N 169445			
			✓	✓	✓	✓			DC1-327D0FB-A66SN 169446			
10.5	2.2	3	-	✓	✓	-	FS2	IP66/NEMA 4X	DC1-32011NB-A66N 169439			
			-	✓	✓	✓			DC1-32011NB-A66SN 169440			
			✓	✓	✓	-	FS2	IP66/NEMA 4X	DC1-32011FB-A66N 169448			
			✓	✓	✓	✓			DC1-32011FB-A66SN 169449			
18 <sup>5)</sup>	4	5	-	✓	✓	-	FS3	IP66/NEMA 4X	DC1-32018NB-A66N 169442			
			-	✓	✓	✓			DC1-32018NB-A66SN 169443			
			✓	✓	✓	-	FS3	IP66/NEMA 4X	DC1-32018FB-A66N 169451			
			✓	✓	✓	✓			DC1-32018FB-A66SN 169452			

**Notes**



- <sup>1)</sup> Overload cycle: 150 % for 60 s every 600 s
- <sup>2)</sup> at 230 V, 50 Hz/at 220 - 240 V, 60 Hz
- <sup>3)</sup> for normal internally and externally ventilated 4 pole, three-phase asynchronous motors with 1500 rpm<sup>-1</sup> at 50 Hz or 1800 min<sup>-1</sup> at 60 Hz
- <sup>4)</sup> Rated operational current at a switching frequency of 16 kHz and an ambient air temperature of +40 °C
- <sup>5)</sup> Rated operational current at a switching frequency of 8 kHz and an ambient air temperature of +40 °C











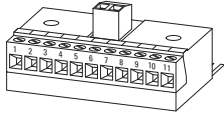

 **Information relevant for export to North America → Page 17**

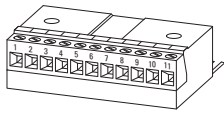
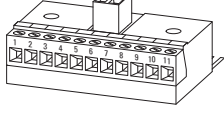

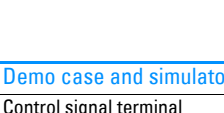
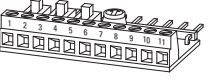

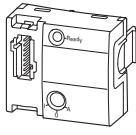



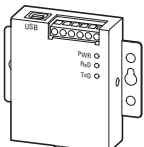

Rated operational current <sup>1), 4)</sup>  I <sub>e</sub> A	Assigned motor rating <sup>1), 2), 3)</sup>		Fitted with				Frame size	Degree of Protection	Part no. Article no.	Price see price list	Std. pack
	P kW	P HP	Radio interference	Brake chopper	7-digital display assembly	Local controls					
<b>PowerXL™ DC1 variable frequency drives</b> U <sub>e</sub> 400 V AC, 3-phase / U <sub>2</sub> 400 V AC, 3-phase Mains voltage (50/60Hz) U <sub>LN</sub> 380 (-10%) - 480 (+10%) V											
2.2	0.75	1	-	-	✓	-	FS1	IP66/NEMA 4X	DC1-342D2NN-A66N 169454	1 off  	
			-	-	✓	✓			DC1-342D2NN-A6SN 169455		
			✓	-	✓	-	DC1-342D2FN-A66N 169476				
			✓	-	✓	✓	DC1-342D2FN-A6SN 169477				
4.1	1.5	2	-	-	✓	-	FS1	IP66/NEMA 4X	DC1-344D1NN-A66N 169457		
			-	-	✓	✓			DC1-344D1NN-A6SN 169458		
			✓	-	✓	-			DC1-344D1FN-A66N 169479		
			✓	-	✓	✓			DC1-344D1FN-A6SN 169480		
			-	✓	✓	-	FS2	DC1-344D1NB-A66N 169460			
			-	✓	✓	✓		DC1-344D1NB-A6SN 169461			
			✓	✓	✓	-		DC1-344D1FB-A66N 169482			
			✓	✓	✓	✓		DC1-344D1FB-A6SN 169483			
5.8	2.2	3	-	✓	✓	-	FS2	IP66/NEMA 4X	DC1-345D8NB-A66N 169463		
			-	✓	✓	✓			DC1-345D8NB-A6SN 169464		
			✓	✓	✓	-			DC1-345D8FB-A66N 169485		
			✓	✓	✓	✓			DC1-345D8FB-A6SN 169486		
9.5	4	5	-	✓	✓	-	FS2	IP66/NEMA 4X	DC1-349D5NB-A66N 169466		
			-	✓	✓	✓			DC1-349D5NB-A6SN 169467		
			✓	✓	✓	-			DC1-349D5FB-A66N 169488		
			✓	✓	✓	✓			DC1-349D5FB-A6SN 169489		
14 <sup>5)</sup>	5.5	10	-	✓	✓	-	FS3	IP66/NEMA 4X	DC1-34014NB-A66N 169469		
			-	✓	✓	✓			DC1-34014NB-A6SN 169470		
			✓	✓	✓	-			DC1-34014FB-A66N 169491		
			✓	✓	✓	✓			DC1-34014FB-A6SN 169492		
18 <sup>5)</sup>	7.5	10	-	✓	✓	-	FS3	IP66/NEMA 4X	DC1-34018NB-A66N 169472		
			-	✓	✓	✓			DC1-34018NB-A6SN 169473		
			✓	✓	✓	-			DC1-34018FB-A66N 169494		
			✓	✓	✓	✓			DC1-34018FB-A6SN 169495		

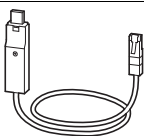
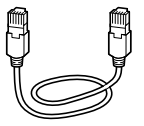
Notes

- 1) Overload cycle: 150 % for 60 s every 600 s
- 2) at 400 V, 50 Hz/at 440 - 480 V, 60 Hz
- 3) for normal internally and externally ventilated 4 pole, three-phase asynchronous motors with 1500 rpm<sup>-1</sup> at 50 Hz or 1800 min<sup>-1</sup> at 60 Hz
- 4) Rated operational current at a switching frequency of 16 kHz and an ambient air temperature of +40 °C
- 5) Rated operational current at a switching frequency of 8 kHz and an ambient air temperature of +40 °C

  Information relevant for export to North America → Page 17

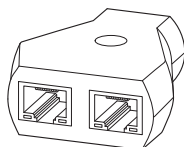
Description	Length	For use with	Part no. Article no.	Price see price list	Std. pack
<b>External keypad</b>					
 With 7-digit display assembly Front IP54 With approx. 3 m-long, plug-in connection cable (RJ45, 8-pin)	3	DE1, DC1, DA1, DL1	<b>DX-KEY-LED</b> 169132		1 off  
with OLED display Front IP54 Multilingual With approx. 3 m-long, plug-in connection cable (RJ45, 8-pin)	3	DC1, DA1, DL1	<b>DX-KEY-OLED</b> 169133		
<b>Expansion modules</b>					
<b>Output expansion</b>					
 2 relay outputs (N/O, 250 V AC/220 V DC, max. 1 A) 1 analog output (0 - +10 V, max. 20 mA) For connecting to the control signal terminals on the DC1	-	DC1	<b>DXC-EXT-2R01A0</b> 169030		1 off  
 2 relay outputs (N/O, 250 V AC/220 V DC, max. 1 A) For connecting to the control signal terminals on the DC1	-	DC1	<b>DXC-EXT-2R0</b> 169031		
<b>Coupling module</b>					
 115-V-AC input (electrically isolated) for 4 digital inputs For connecting to the control signal terminals on the DC1	-	DC1	<b>DXC-EXT-IO110</b> 169032		1 off  
 230-V-AC input (electrically isolated) for 4 digital inputs For connecting to the control signal terminals on the DC1	-	DC1	<b>DXC-EXT-IO230</b> 169033		
<b>Demo case and simulator</b>					
<b>Control signal terminal simulator</b>					
 Commissioning and testing simulator 3 digital inputs (+24 V) 1 relay output (max. 30 V DC) 3 microswitches 1 reference value potentiometer (0 - +10 V / = 0 - f <sub>max</sub> ) For connecting to the control signal terminals on the DC1	-	DC1	<b>DXC-EXT-LOCSIM</b> 169034		1 off  
<b>SmartWire-DT Modules</b>					
 Plug-in module (front) with slot for SWD4-8SF2-5 external device plug	-	DE1, DC1 (IP20)	<b>DX-NET-SWD3</b> 169131		1 off  
<b>PC communication</b>					
 Parameter storage unit and Bluetooth communication stick For storage, copying parameters, and/or transferring parameters to a PC with the drivesConnect software via Bluetooth With 2 function keys for uploading and downloading parameters with configuration memory	-	DE1, DC1, DA1, DL1	<b>DX-COM-STICK</b> 169134		1 off

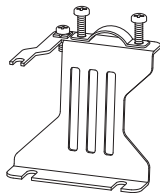
Description	Length	For use with	Part no. Article no.	Price see price list	Std. pack	
<b>PC communication</b>						
<b>Interface converter</b> For directly connecting the variable-frequency drive to a computer with drivesConnect software						
	Interface converter USB/RS485 with connection cable, RJ45, 8 pole electrically isolated 1 x SUB-D plug, 9-pole Terminal strip, 5-terminal Status-LED	-	DE1, DC1, DA1, DL1	<b>DX-COM-PCKIT</b> 169135	1 off  	
	Interface converter USB/RS485 with connection cable, RJ45, 8 pole electrically isolated	-	DE1, DC1, DA1, DL1	<b>DX-CBL-PC-1M5</b> 171018	1 off	
<b>Connecting cable</b>						
	Patch cord with RJ45 plugs, 8 pole	0.5 1 3	DE1, DC1, DA1, DL1	<b>DX-CBL-RJ45-0M5</b> 169137 <b>DX-CBL-RJ45-1M0</b> 169138 <b>DX-CBL-RJ45-3M0</b> 169139	1 off  	
<b>Bus terminating resistor</b>						
	RJ45 8 pole Connection to CANopen® (pin 1/2, 124 Ω) or to Modbus RTU (pin 7/8, 120 Ω)	-	easyNet DX-SPL-RJ45-2SL-1PL	<b>EASY-NT-R</b> 256281	2 off  	
<b>Splitter</b>						
	RJ45, 8-pin, 3 sockets	-	DX-CBL-RJ45...	<b>DX-SPL-RJ45-3SL</b> 169141	1 off  	
	RJ45, 8-pin, 2 sockets/1 plug	-	DX-CBL-RJ45...	<b>DX-SPL-RJ45-2SL1PL</b> 169142		
<b>mounting accessories</b>						
<b>mounting adapter</b> With gland plates						
	For installing the connection cables on the mains side	Size FS1 Size FS2 Size FS3	- - -	DC1 DC1, DA1, DL1 DC1, DA1, DL1	<b>DX-EMC-MNT-1N</b> 172925 <b>DX-EMC-MNT-2N</b> 172927 <b>DX-EMC-MNT-3N</b> 172929	1 off
	For installing the connection cables on the motor side	Size FS1 Size FS2 Size FS3	- - -	DC1 DC1, DA1, DL1 DC1, DA1, DL1	<b>DX-EMC-MNT-1M</b> 172926 <b>DX-EMC-MNT-2M</b> 172928 <b>DX-EMC-MNT-3M</b> 172930	



**Information relevant for export to North America**

Product Standards	UL 508C; CSA-C22.2 No. 14; IEC/EN61800-3; IEC/EN61800-5; CE marking
UL File No.	E172143
UL Category Control No.	NMMS, NMMS7
CSA File No.	UL report applies to both US and Canada
North America Certification	UL listed, certified by UL for use in Canada
Suitable for	Branch circuits

**EASY-NT-R:**

Product Standards	IEC/EN see Technical Data; UL 508; CSA C22.2 No. 142-M1987; CSA C22.2 No. 213-M1987; CE marking
UL File No.	E135462
UL Category Control No.	NRAQ
CSA File No.	012528
CSA Class No.	2258-02
North America Certification	UL listed, CSA certified
Degree of Protection	IEC: IP20, UL/CSA Type: -



# PowerXL™ Variable Frequency Drive DA1 Advanced Machinery Drive

The PowerXL™ DA1 variable frequency drive, designed for the machine and system building industry, is characterized by its enormous flexibility in terms of communications protocols, a function block editor (PLC) that makes it possible to configure the drive as necessary for specific applications, and a powerful vector control mode for highly dynamic applications.

#### Performance range:

- 0.75 ... 2.2 kW ( $U_g$ : 1~ 230 V,  $U_2$ : 3~ 230 V)
- 0.75 ... 75 kW ( $U_g$ : 3~ 230 V,  $U_2$ : 3~ 230 V)
- 0.75 ... 250 kW ( $U_g$ : 3~ 400 V,  $U_2$ : 3~ 400 V)
- 0.75 ... 110 kW ( $U_g$ : 3~ 575 V,  $U_2$ : 3~ 575 V)

#### Features:

- Large overload capability: 150% for 60 seconds, 200% for 4 seconds
- Integrated Modbus RTU and CANopen
- Ambient air temperature up to 50 °C without derating
- Integrated EMC filter
- Integrated braking transistor
- Various I/O expansions
- V/F control, vector SL and CL, PM motor, BLDC motor, SynRel motor
- Optional field bus connections
- Safe Torque Off (STO, SIL 2/PI d)
- Optional high-resolution OLED display
- International standards (CE, UL, cUL, c-Tick, RoHS, Gost-R, UkrSEPRO, DNV (754-757))

#### Accessories:

- SmartWire-DT connection
- Communication modules (PROFIBUS, PROFINET, Ethernet/IP, EtherCAT, DeviceNet, etc.)
- I/O expansions
- External keypad
- Mains chokes
- Motor chokes
- Sine filters
- Braking resistances
- drivesConnect parameter configuration software
- External EMC filter

#### Applications:

- Winding machines
- Respooler machines
- Coating systems
- Compressors
- Mills, roller mills, shredders
- Extruders
- Cranes and lifting systems
- Marine
- Distributed applications (IP66)



System overview	30
Key to type references	31
UL/CSA	31
Sizes and degree of protection	32
Ordering	
Variable frequency drives DA1, IP20/IP55	33
Variable frequency drives DA1, IP66	36
Accessories	38

**System overview**

DA1 with IP20 degree of protection

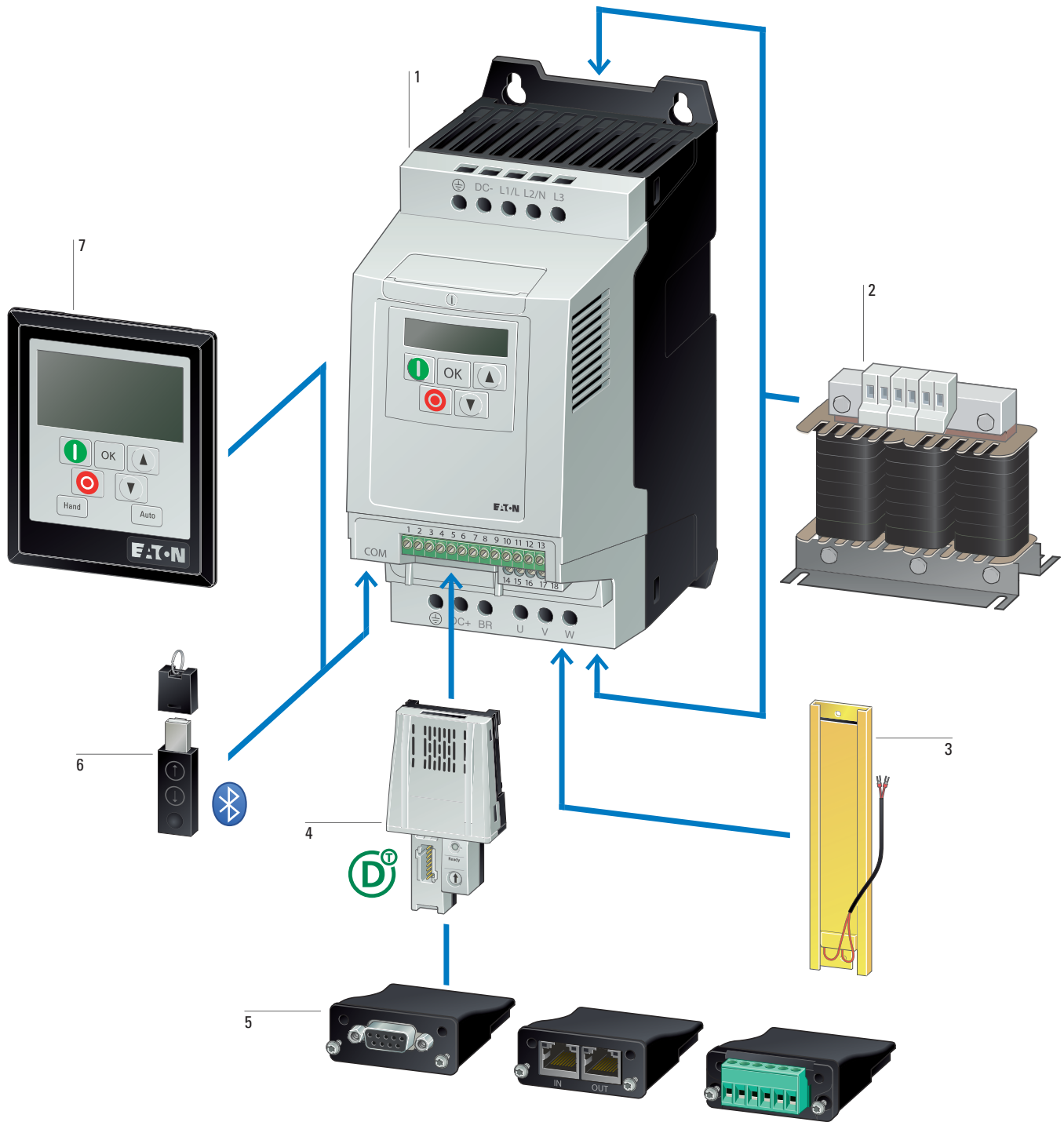

DA1 variable frequency drives 1

→ page 33

Mains choke, motor choke, sine filter 2

→ page 60, → page 61

Braking resistance 3

→ page 56

SmartWire-DT module 4

→ page 38

Communication modules, expansion modules 5

→ page 38

Memory and Bluetooth communication stick 6

→ page 39

External keypad 7

→ page 38



**Key to type references**

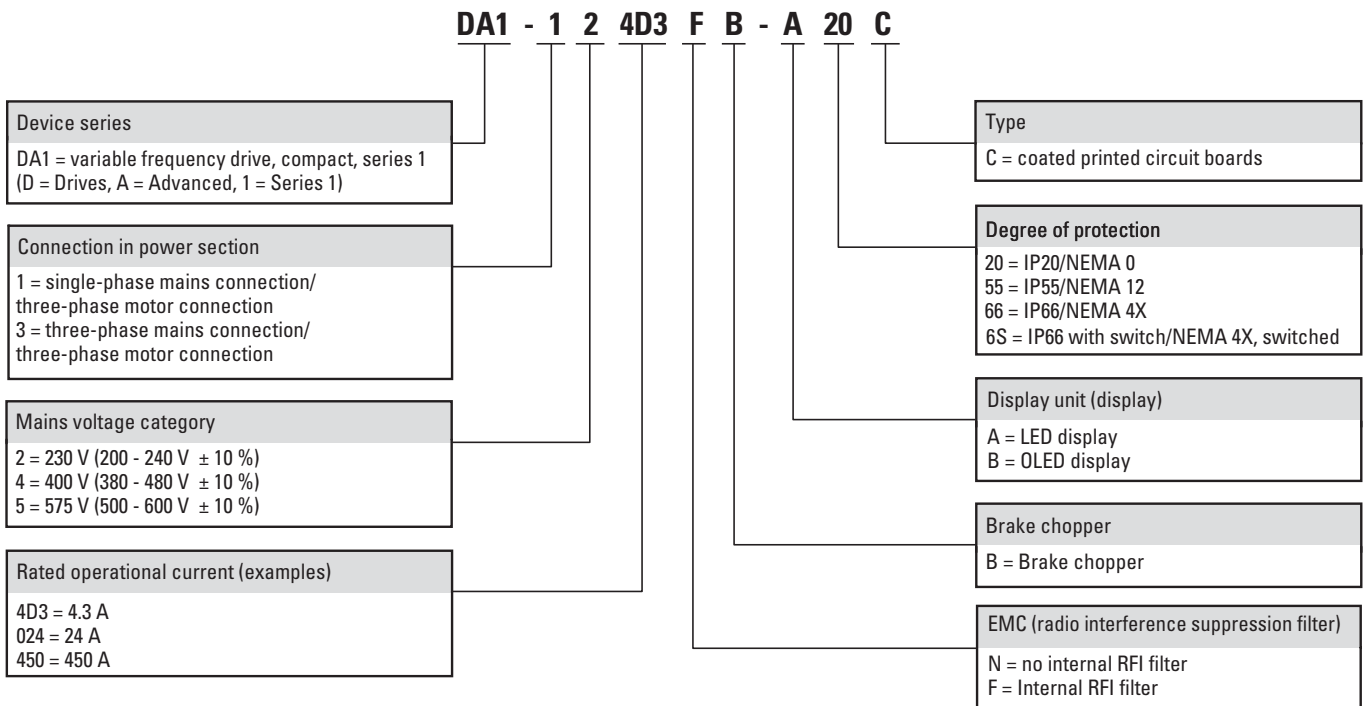

DA1

**UL/CSA**

**Information relevant for export to North America**

Product Standards	UL 508C; CSA-C22.2 No. 14; IEC/EN61800-3; IEC/EN61800-5; CE marking
UL File No.	E172143
UL Category Control No.	NMMS, NMMS7
CSA File No.	UL report applies to both US and Canada
North America Certification	UL listed, certified by UL for use in Canada
Suitable for	Branch circuits
Max. Voltage Rating	3~ 240 V AC IEC: TN-S UL/CSA: "Y" (Solidly Grounded Wey) 3~ 480 V AC IEC: TN-S UL/CSA: "Y" (Solidly Grounded Wey)

Sizes and degree of protection

Frame size Degree of Protection  
IP20/NEMA 0

IP66/NEMA 4X

IP66/NEMA 4X  
Local controls

FS2

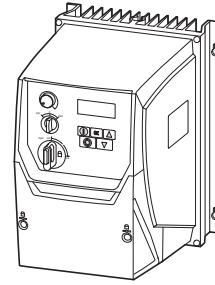
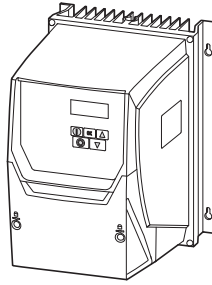
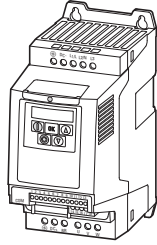

FS3

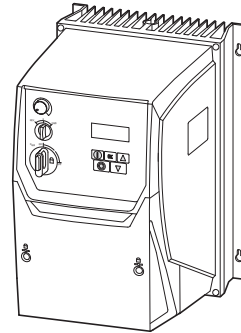
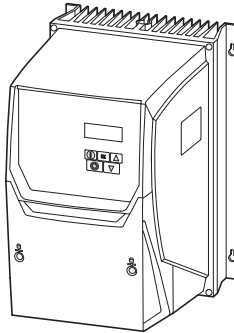
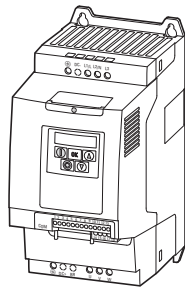

Frame size Degree of Protection  
IP55/NEMA 12



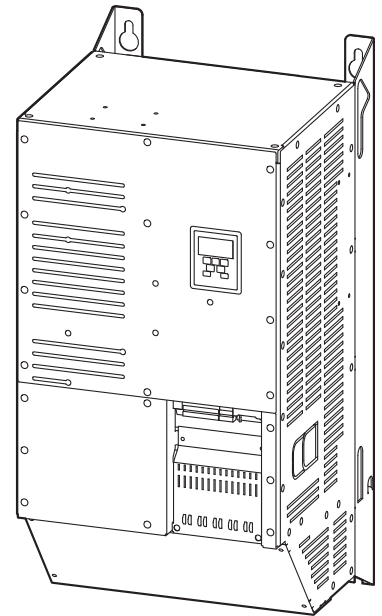
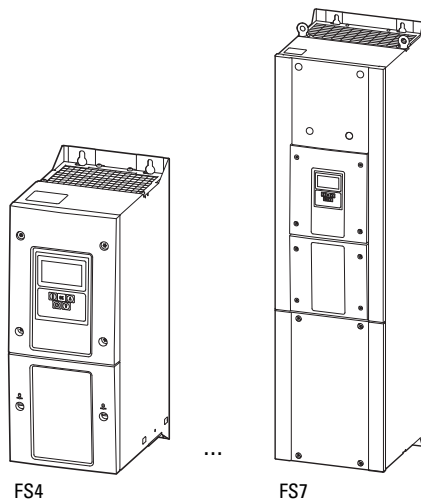

Frame size Degree of Protection  
IP20/NEMA 0

FS4-FS7

FS8





Note: Figures are not true to scale

Rated operational current <sup>1), 4)</sup>  I <sub>e</sub> A	Assigned motor rating <sup>1), 2), 3)</sup>		Fitted with							Frame size	Degree of Protection	Part no. Article no.	Price see price list	Std. pack
	P kW	P HP	Radio interference	Brake chopper	DC link choke	7-digital display assembly	OLED display	Additional PCB protection	Local controls					
<b>PowerXL™ DA1 variable frequency drives</b>														
U <sub>e</sub> 230 V AC, 1-phase / U <sub>2</sub> 230 V AC, 3-phase Mains voltage (50/60Hz) U <sub>LN</sub> 200 (-10%) - 240 (+10%) V														
4.3	0.75	1	✓	✓	-	✓	-	✓	-	FS2	IP20/NEMA 0	<b>DA1-124D3FB-A20C</b> 169078		1 off  
7	1.5	2	✓	✓	-	✓	-	✓	-			<b>DA1-127D0FB-A20C</b> 169081		
10.5	2.2	3	✓	✓	-	✓	-	✓	-			<b>DA1-12011FB-A20C</b> 169084		
U <sub>e</sub> 230 V AC, 3-phase / U <sub>2</sub> 230 V AC, 3-phase Mains voltage (50/60Hz) U <sub>LN</sub> 200 (-10%) - 240 (+10%) V														
4.3	0.75	1	✓	✓	-	✓	-	✓	-	FS2	IP20/NEMA 0	<b>DA1-324D3FB-A20C</b> 169087		1 off  
7	1.5	2	✓	✓	-	✓	-	✓	-			<b>DA1-327D0FB-A20C</b> 169090		
10.5	2.2	3	✓	✓	-	✓	-	✓	-			<b>DA1-32011FB-A20C</b> 169093		
18	4	5	✓	✓	-	✓	-	✓	-	FS3		<b>DA1-32018FB-A20C</b> 169096		
24	5.5	7.5	✓	✓	-	✓	-	✓	-			<b>DA1-32024FB-A20C</b> 169099		
24 <sup>5)</sup>			✓	✓	-	-	✓	✓	-	FS4	IP55/NEMA 12	<b>DA1-32024FB-B55C</b> 169361		
30	7.5	10	✓	✓	-	-	✓	✓	-			<b>DA1-32030FB-B55C</b> 169362		
46	11	15	✓	✓	-	-	✓	✓	-			<b>DA1-32046FB-B55C</b> 169363		
61	15	20	✓	✓	✓	-	✓	✓	-	FS5		<b>DA1-32061FB-B55C</b> 169364		
72	22	25	✓	✓	✓	-	✓	✓	-			<b>DA1-32072FB-B55C</b> 169365		
90 <sup>5)</sup>	22	30	✓	✓	✓	-	✓	✓	-	FS6		<b>DA1-32090FB-B55C</b> 169367		
110 <sup>5)</sup>	30	40	✓	✓	✓	-	✓	✓	-			<b>DA1-32110FB-B55C</b> 169369		
150 <sup>5)</sup>	45	50	✓	✓	✓	-	✓	✓	-			<b>DA1-32150FB-B55C</b> 169371		
180 <sup>5)</sup>	55	60	✓	✓	✓	-	✓	✓	-			<b>DA1-32180FB-B55C</b> 169373		
202 <sup>5)</sup>		75	✓	✓	✓	-	✓	✓	-	FS7		<b>DA1-32202FB-B55C</b> 169375		
248 <sup>5)</sup>	75	100	✓	✓	✓	-	✓	✓	-			<b>DA1-32248FB-B55C</b> 169377		

**Notes**

- 1) Overload cycle for 60 s every 600 s
- 2) at 230 V, 50 Hz/at 220 - 240 V, 60 Hz
- 3) for normal internally and externally ventilated 4 pole, three-phase asynchronous motors with 1500 rpm<sup>-1</sup> at 50 Hz or 1800 min<sup>-1</sup> at 60 Hz
- 4) IP20/NEMA 0: Rated operational current at an operating frequency of 16 kHz and an ambient air temperature of +50 °C
- IP55/NEMA 12: Rated operational current at a switching frequency of 16 kHz and an ambient air temperature of +40 °C
- 5) IP20/NEMA 0: Rated operational current at a switching frequency of 8 kHz and an ambient air temperature of +50 °C
- IP55/NEMA 12: Rated operational current at a switching frequency of 8 kHz and an ambient air temperature of +40 °C

  **Information relevant for export to North America → Page 31**

DA1

Rated operational current <sup>1), 4)</sup> <i>I<sub>e</sub></i> A	Assigned motor rating <sup>1), 2), 3)</sup>		Fitted with							Frame size	Degree of Protection	Part no. Article no.	Price see price list	Std. pack
	P kW	P HP	Radio interference	Brake chopper	DC link choke	7-digital display assembly	OLED display	Additional PCB protection	Local controls					
<b>PowerXL™ DA1 variable frequency drives</b>														
U <sub>e</sub> 400 V AC, 3-phase / U <sub>2</sub> 400 V AC, 3-phase Mains voltage (50/60Hz) U <sub>LN</sub> 380 (-10%) - 480 (+10%) V														
2.2	0.75	1	✓	✓	-	✓	-	✓	-	FS2	IP20/NEMA 0	DA1-342D2FB-A20C 169117	1 off 	
4.1	1.5	2	✓	✓	-	✓	-	✓	-					
5.8	2.2	3	✓	✓	-	✓	-	✓	-					
9.5	4	5	✓	✓	-	✓	-	✓	-					
14	5.5	10	✓	✓	-	✓	-	✓	-	FS3	IP20/NEMA 0	DA1-34014FB-A20C 169057	1 off 	
18	7.5	10	✓	✓	-	✓	-	✓	-					
24	11	15	✓	✓	-	✓	-	✓	-	FS4	IP55/NEMA 12	DA1-34024FB-A20C 169063		
30	15	20	✓	✓	-	-	✓	✓	-					
39	18.5	25	✓	✓	-	-	✓	✓	-	FS5	IP55/NEMA 12	DA1-34030FB-B55C 169391	1 off 	
46	22	30	✓	✓	-	-	✓	✓	-					
61	30	40	✓	✓	✓	-	✓	✓	-					
72	37	50	✓	✓	✓	-	✓	✓	-	FS6	IP55/NEMA 12	DA1-34072FB-B55C 169395		
90 <sup>5)</sup>	45	60	✓	✓	✓	-	✓	✓	-					
110 <sup>5)</sup>	55	75	✓	✓	✓	-	✓	✓	-	FS7	IP55/NEMA 12	DA1-34090FB-B55C 169397	1 off 	
150 <sup>5)</sup>	75	100	✓	✓	✓	-	✓	✓	-					
180 <sup>5)</sup>	90	150	✓	✓	✓	-	✓	✓	-					
202 <sup>5)</sup>	110	200	✓	✓	✓	-	✓	✓	-	FS8	IP20/NEMA 0	DA1-34202FB-B55C 169405		
240 <sup>5)</sup>	132	200	✓	✓	✓	-	✓	✓	-					
302 <sup>5)</sup>	160	250	✓	✓	✓	-	✓	✓	-	FS8	IP20/NEMA 0	DA1-34302FB-B55C 169217	1 off 	
370 <sup>5)</sup>	200	300	✓	✓	-	-	✓	✓	-					
450 <sup>5)</sup>	250	350	✓	✓	-	-	✓	✓	-					

**Notes**

- <sup>1)</sup> Overload cycle for 60 s every 600 s
- <sup>2)</sup> at 400 V, 50 Hz/at 440 - 480 V, 60 Hz
- <sup>3)</sup> for normal internally and externally ventilated 4 pole, three-phase asynchronous motors with 1500 rpm<sup>-1</sup> at 50 Hz or 1800 min<sup>-1</sup> at 60 Hz
- <sup>4)</sup> IP20/NEMA 0: Rated operational current at a switching frequency of 8 kHz and an ambient air temperature of +50 °C  
IP55/NEMA 12: Rated operational current at a switching frequency of 8 kHz and an ambient air temperature of +40 °C
- <sup>5)</sup> IP20/NEMA 0: Rated operational current at an operating frequency of 4 kHz and an ambient air temperature of +50 °C  
IP55/NEMA 12: Rated operational current at an operating frequency of 4 kHz and an ambient air temperature of +40 °C

Information relevant for export to North America → Page 31





Rated operational current <sup>1), 4)</sup>  <i>I<sub>e</sub></i> A	Assigned motor rating <sup>1), 2), 3)</sup>		Fitted with							Frame size	Degree of Protection	Part no. Article no.	Price see price list	Std. pack
	P kW	P HP	Radio interference	Brake chopper	DC link choke	7-digital display assembly	OLED display	Additional PCB protection	Local controls					
<b>PowerXL™ DA1 variable frequency drives</b>														
U <sub>e</sub> 500 V AC, 3-phase / U <sub>2</sub> 500 V AC, 3-phase Mains voltage (50/60Hz) U <sub>LN</sub> 500 (-10%) - 600 (+10%) V														
2.1	0.75	1.5	-	✓	-	✓	-	✓	-	FS2	IP20/NEMA 0	DA1-352D1NB-A20C 177034	1 off 	
3.1	1.5	2	-	✓	-	✓	-	✓	-			DA1-353D1NB-A20C 177035		
4.1	2.2	3	-	✓	-	✓	-	✓	-			DA1-354D1NB-A20C 177036		
6.5	4	5	-	✓	-	✓	-	✓	-			DA1-356D5NB-A20C 177037		
9	5.5	7.5	-	✓	-	✓	-	✓	-			DA1-359D0NB-A20C 177038		
12	7.5	10	-	✓	-	✓	-	✓	-			DA1-35012NB-A20C 177039		
17	11	15	-	✓	-	✓	-	✓	-	FS3	IP20/NEMA 0	DA1-35017NB-A20C 177040	1 off 	
22	15	20	-	✓	-	✓	-	✓	-			DA1-35022NB-A20C 177041		
28	18.5	25	-	✓	-	-	✓	✓	-	FS4	IP55/NEMA 12	DA1-35022NB-B55C 176965		
34	22	30	-	✓	-	-	✓	✓	-			DA1-35028NB-B55C 176966		
43	30	40	-	✓	✓	-	✓	✓	-	FS4	IP55/NEMA 12	DA1-35034NB-B55C 176967		
54	37	50	-	✓	✓	-	✓	✓	-			DA1-35043NB-B55C 176968		
65	45	60	-	✓	✓	-	✓	✓	-	FS5	IP55/NEMA 12	DA1-35054NB-B55C 176969		
78 <sup>5)</sup>	55	75	-	✓	✓	-	✓	✓	-			DA1-35065NB-B55C 176970		
105 <sup>5)</sup>	75	100	-	✓	✓	-	✓	✓	-	FS5	IP55/NEMA 12	DA1-35078NB-B55C 176971		
130 <sup>5)</sup>	90	125	-	✓	✓	-	✓	✓	-			DA1-35105NB-B55C 176972		
150 <sup>5)</sup>	110	150	-	✓	✓	-	✓	✓	-	FS6	IP55/NEMA 12	DA1-35130NB-B55C 176973		
			-	✓	✓	-	✓	✓	-			DA1-35150NB-B55C 176974		

**Notes**

- 1) Overload cycle for 60 s every 600 s
- 2) at 500 V, 50 Hz/at 550 - 600 V, 60 Hz
- 3) for normal internally and externally ventilated 4 pole, three-phase asynchronous motors with 1500 rpm<sup>-1</sup> at 50 Hz or 1800 min<sup>-1</sup> at 60 Hz
- 4) IP20/NEMA 0: Rated operational current at a switching frequency of 8 kHz and an ambient air temperature of +50 °C  
IP55/NEMA 12: Rated operational current at a switching frequency of 8 kHz and an ambient air temperature of +40 °C
- 5) IP20/NEMA 0: Rated operational current at an operating frequency of 4 kHz and an ambient air temperature of +50 °C  
IP55/NEMA 12: Rated operational current at an operating frequency of 4 kHz and an ambient air temperature of +40 °C



Information relevant for export to North America → Page 31





DA1

Rated operational current <sup>1), 4)</sup> <i>I<sub>e</sub></i> A	Assigned motor rating <sup>1), 2), 3)</sup>		Fitted with							Frame size	Degree of Protection	Part no. Article no.	Price see price list	Std. pack
	P kW	P HP	Radio interference	Brake chopper	DC link choke	7-digital display assembly	OLED display	Additional PCB protection	Local controls					
<b>PowerXL™ DA1 variable frequency drives</b>														
U <sub>e</sub> 230 V AC, 1-phase / U <sub>2</sub> 230 V AC, 3-phase Mains voltage (50/60Hz) U <sub>LN</sub> 200 (-10%) - 240 (+10%) V														
4.3	0.75	1	✓	✓	-	-	✓	✓	-	FS2	IP66/NEMA 4X	DA1-124D3FB-B66C 169347		1 off  
			✓	✓	-	-	✓	✓	✓			DA1-124D3FB-B6SC 169348		
7	1.5	2	✓	✓	-	-	✓	✓	-	FS2	IP66/NEMA 4X	DA1-127D0FB-B66C 169349		
			✓	✓	-	-	✓	✓	✓			DA1-127D0FB-B6SC 169350		
10.5	2.2	3	✓	✓	-	-	✓	✓	-	FS2	IP66/NEMA 4X	DA1-12011FB-B66C 169351		
			✓	✓	-	-	✓	✓	✓			DA1-12011FB-B6SC 169352		
U <sub>e</sub> 230 V AC, 3-phase / U <sub>2</sub> 230 V AC, 3-phase Mains voltage (50/60Hz) U <sub>LN</sub> 200 (-10%) - 240 (+10%) V														
4.3	0.75	1	✓	✓	-	-	✓	✓	-	FS2	IP66/NEMA 4X	DA1-324D3FB-B66C 169353		1 off  
			✓	✓	-	-	✓	✓	✓			DA1-324D3FB-B6SC 169354		
7	1.5	2	✓	✓	-	-	✓	✓	-	FS2	IP66/NEMA 4X	DA1-327D0FB-B66C 169355		
			✓	✓	-	-	✓	✓	✓			DA1-327D0FB-B6SC 169356		
10.5	2.2	3	✓	✓	-	-	✓	✓	-	FS2	IP66/NEMA 4X	DA1-32011FB-B66C 169357		
			✓	✓	-	-	✓	✓	✓			DA1-32011FB-B6SC 169358		
18	4	5	✓	✓	-	-	✓	✓	-	FS3	IP66/NEMA 4X	DA1-32018FB-B66C 169359		
			✓	✓	-	-	✓	✓	✓			DA1-32018FB-B6SC 169360		

**Notes**



- 1) Overload cycle for 60 s every 600 s
- 2) at 230 V, 50 Hz/at 220 - 240 V, 60 Hz
- 3) for normal internally and externally ventilated 4 pole, three-phase asynchronous motors with 1500 rpm<sup>-1</sup> at 50 Hz or 1800 min<sup>-1</sup> at 60 Hz
- 4) Rated operational current at a switching frequency of 16 kHz and an ambient air temperature of +40 °C









  **Information relevant for export to North America → Page 31**

Rated operational current <sup>1), 4)</sup>  <i>I<sub>e</sub></i> A	Assigned motor rating <sup>1), 2), 3)</sup>		Fitted with							Frame size	Degree of Protection	Part no. Article no.	Price see price list	Std. pack
	P kW	P HP	Radio interference	Brake chopper	DC link choke	7-digital display assembly	OLED display	Additional PCB protection	Local controls					
<b>PowerXL™ DA1 variable frequency drives</b>														
U <sub>e</sub> 400 V AC, 3-phase / U <sub>2</sub> 400 V AC, 3-phase Mains voltage (50/60Hz) U <sub>LN</sub> 380 (-10%) - 480 (+10%) V														
2.2	0.75	1	✓	✓	-	-	✓	✓	-	FS2	IP66/NEMA 4X	DA1-342D2FB-B66C 169378		1 off  
			✓	✓	-	-	✓	✓	✓			DA1-342D2FB-B6SC 169379		
4.1	1.5	2	✓	✓	-	-	✓	✓	-	FS2	IP66/NEMA 4X	DA1-344D1FB-B66C 169380		
			✓	✓	-	-	✓	✓	✓			DA1-344D1FB-B6SC 169381		
5.8	2.2	3	✓	✓	-	-	✓	✓	-	FS2	IP66/NEMA 4X	DA1-345D8FB-B66C 169382		
			✓	✓	-	-	✓	✓	✓			DA1-345D8FB-B6SC 169383		
9.5	4	5	✓	✓	-	-	✓	✓	-	FS2	IP66/NEMA 4X	DA1-349D5FB-B66C 169384		
			✓	✓	-	-	✓	✓	✓			DA1-349D5FB-B6SC 169385		
14	5.5	10	✓	✓	-	-	✓	✓	-	FS3	IP66/NEMA 4X	DA1-34014FB-B66C 169386		
			✓	✓	-	-	✓	✓	✓			DA1-34014FB-B6SC 169387		
18	7.5	10	✓	✓	-	-	✓	✓	-	FS3	IP66/NEMA 4X	DA1-34018FB-B66C 169388		
			✓	✓	-	-	✓	✓	✓			DA1-34018FB-B6SC 169389		
U <sub>e</sub> 500 V AC, 3-phase / U <sub>2</sub> 500 V AC, 3-phase Mains voltage (50/60Hz) U <sub>LN</sub> 500 (-10%) - 600 (+10%) V														
2.1	0.75	1.5	-	✓	-	-	✓	✓	-	FS2	IP66/NEMA 4X	DA1-352D1NB-B66C 176984		1 off  
			-	✓	-	-	✓	✓	✓			DA1-352D1NB-B6SC 177012		
3.1	1.5	2	-	✓	-	-	✓	✓	-	FS2	IP66/NEMA 4X	DA1-353D1NB-B66C 176985		
			-	✓	-	-	✓	✓	✓			DA1-353D1NB-B6SC 177013		
4.1	2.2	3	-	✓	-	-	✓	✓	-	FS2	IP66/NEMA 4X	DA1-354D1NB-B66C 176986		
			-	✓	-	-	✓	✓	✓			DA1-354D1NB-B6SC 177014		
6.5	4	5	-	✓	-	-	✓	✓	-	FS2	IP66/NEMA 4X	DA1-356D5NB-B66C 176987		
			-	✓	-	-	✓	✓	✓			DA1-356D5NB-B6SC 177015		
9	5.5	7.5	-	✓	-	-	✓	✓	-	FS2	IP66/NEMA 4X	DA1-359D0NB-B66C 176988		
			-	✓	-	-	✓	✓	✓			DA1-359D0NB-B6SC 177016		
12	7.5	10	-	✓	-	-	✓	✓	-	FS3	IP66/NEMA 4X	DA1-35012NB-B66C 176989		
			-	✓	-	-	✓	✓	✓			DA1-35012NB-B6SC 177017		
17	11	15	-	✓	-	-	✓	✓	-	FS3	IP66/NEMA 4X	DA1-35017NB-B66C 176990		
			-	✓	-	-	✓	✓	✓			DA1-35017NB-B6SC 177018		

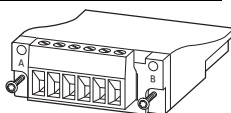
Notes

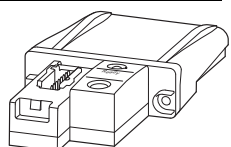
- <sup>1)</sup> Overload cycle for 60 s every 600 s
- <sup>2)</sup> DA1-34...: at 400 V, 50 Hz/at 440 - 480 V, 60 Hz  
DA1-35...: at 500 V, 50 Hz/at 550 - 600 V, 60 Hz
- <sup>3)</sup> for normal internally and externally ventilated 4 pole, three-phase asynchronous motors with 1500 rpm<sup>-1</sup> at 50 Hz or 1800 min<sup>-1</sup> at 60 Hz
- <sup>4)</sup> Rated operational current at a switching frequency of 8 kHz and an ambient air temperature of +40 °C

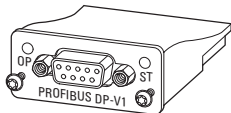
  Information relevant for export to North America → Page 31

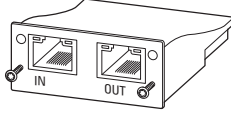
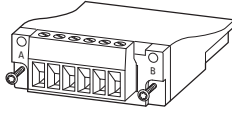





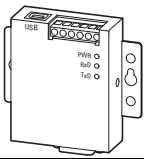

	Description	Length	For use with	Part no. Article no.	Price see price list	Std. pack
<b>External keypad</b>						
	With 7-digit display assembly Front IP54 With approx. 3 m-long, plug-in connection cable (RJ45, 8-pin)	3	DE1, DC1, DA1, DL1	<b>DX-KEY-LED</b> 169132		1 off  
	with OLED display Front IP54 Multilingual With approx. 3 m-long, plug-in connection cable (RJ45, 8-pin)	3	DC1, DA1, DL1	<b>DX-KEY-OLED</b> 169133		
<b>Expansion modules</b>						
	Output expansion Plug-in module with plug-in terminal block, 5 pole 3 relay outputs (N/O, 250 V AC, max. 6 A/ 30 V DC, max. 5 A)	-	DA1, DL1	<b>DXA-EXT-3RO</b> 169121		1 off  
	I/O expansion Plug-in module with plug-in terminal blocks, 6 pole 3 digital inputs (+24 V) 1 relay output (N/O, 250 V AC, max. 6 A/ 30 V DC, max. 5 A)	-	DA1, DL1	<b>DXA-EXT-3DI1RO</b> 169036		
	Encoder module Plug-in module with plug-in terminal block, 5 pole 2-channel max. 500 kHz 5 V TTL, A & B, /A & /B, 5 V DC, max. 200 mA 24 V HTL, A & B, /A & /B, 24 V DC, external power supply required, max. 30 V DC	-	DA1, DL1	<b>DXA-EXT-ENCOD</b> 169035		
<b>SmartWire-DT Modules</b>						
	Plug-in module with slot for SWD4-8SF2-5 external device plug	-	DA1 (IP20, IP55)	<b>DX-NET-SWD1</b> 169129		1 off  
<b>Fieldbus modules</b>						
	PROFIBUS-DP SUB-D socket, 9-pole	-	DA1, DL1	<b>DX-NET-PROFIBUS</b> 169124		1 off  
	PROFINET 2 x RJ45, 8 pole Plug-in module	-	DA1, DL1	<b>DX-NET-PROFINET-2</b> 169125		
	Modbus-TCP 2 x RJ45, 8 pole	-	DA1, DL1	<b>DX-NET-MODBUSTCP-2</b> 169126		
	EtherNet/IP 2 x RJ45, 8 pole	-	DA1, DL1	<b>DX-NET-ETHERNET-2</b> 169122		
	EtherCAT 2 x RJ45, 8 pole	-	DA1, DL1	<b>DX-NET-ETHERCAT-2</b> 169127		
	DeviceNet	-	DA1, DL1	<b>DX-NET-DEVICENET</b> 169123		

  **Information relevant for export to North America**

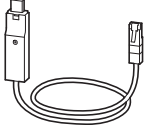
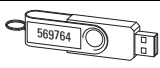
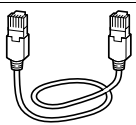
Product Standards	UL 508C; CSA-C22.2 No. 14; IEC/EN61800-3; IEC/EN61800-5; CE marking
UL File No.	E172143
UL Category Control No.	NMMS, NMMS7
CSA File No.	UL report applies to both US and Canada
North America Certification	UL listed, certified by UL for use in Canada
Suitable for	Branch circuits

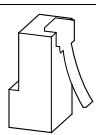

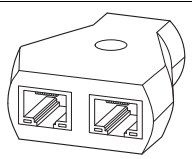
DA1

Description	Length	For use with	Part no. Article no.	Price see price list	Std. pack
<b>PC communication</b>					
<b>Parameter storage unit and Bluetooth communication stick</b>					
		DE1, DC1, DA1, DL1	<b>DX-COM-STICK</b> 169134		1 off
For storage, copying parameters, and/or transferring parameters to a PC with the drivesConnect software via Bluetooth With 2 function keys for uploading and downloading parameters with configuration memory	-				
<b>Interface converter</b> For directly connecting the variable-frequency drive to a computer with drivesConnect software					
		DE1, DC1, DA1, DL1	<b>DX-COM-PCKIT</b> 169135		1 off  
Interface converter USB/RS485 with connection cable, RJ45, 8 pole electrically isolated 1 x SUB-D plug, 9-pole Terminal strip, 5-terminal Status-LED	-				
		DE1, DC1, DA1, DL1	<b>DX-CBL-PC-1M5</b> 171018		1 off
Interface converter USB/RS485 with connection cable, RJ45, 8 pole electrically isolated	-				
<b>License Keys</b> to activate the function block editor in the DrivesConnect software					
		DA1, DL1	<b>DX-COM-SOFT</b> 169136		
USB flash drive	-				
<b>Connecting cable</b>					
	0.5 1 3	DE1, DC1, DA1, DL1	<b>DX-CBL-RJ45-0M5</b> 169137 <b>DX-CBL-RJ45-1M0</b> 169138 <b>DX-CBL-RJ45-3M0</b> 169139		1 off  
Patch cord with RJ45 plugs, 8 pole					
<b>Bus terminating resistor</b>					
		easyNet DX-SPL-RJ45-2SL-1PL	<b>EASY-NT-R</b> 256281		2 off  
RJ45 8 pole Connection to CANopen® (pin 1/2, 124 Ω) or to Modbus RTU (pin 7/8, 120 Ω)	-				
<b>Splitter</b>					
		DX-CBL-RJ45...	<b>DX-SPL-RJ45-3SL</b> 169141 <b>DX-SPL-RJ45-2SL1PL</b> 169142		1 off  
RJ45, 8-pin, 3 sockets RJ45, 8-pin, 2 sockets/1 plug	- -				



**Information relevant for export to North America**

Product Standards	UL 508C; CSA-C22.2 No. 14; IEC/EN61800-3; IEC/EN61800-5; CE marking
UL File No.	E172143
UL Category Control No.	NMMS, NMMS7
CSA File No.	UL report applies to both US and Canada
North America Certification	UL listed, certified by UL for use in Canada
Suitable for	Branch circuits

**EASY-NT-R:**

Product Standards	IEC/EN see Technical Data; UL 508; CSA C22.2 No. 142-M1987; CSA C22.2 No. 213-M1987; CE marking
UL File No.	E135462
UL Category Control No.	NRAQ
CSA File No.	012528
CSA Class No.	2258-02
North America Certification	UL listed, CSA certified
Degree of Protection	IEC: IP20, UL/CSA Type: -

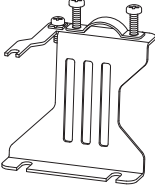
Description	Length	For use with	Part no. Article no.	Price see price list	Std. pack	
<b>mounting accessories</b>						
<b>mounting adapter with gland plates</b>						
	For installing the connection cables on the mains side	Size FS2	-	DC1, DA1, DL1	<b>DX-EMC-MNT-2N</b> 172927	1 off
		Size FS3	-	DC1, DA1, DL1	<b>DX-EMC-MNT-3N</b> 172929	
	For installing the connection cables on the motor side	Size FS2	-	DC1, DA1, DL1	<b>DX-EMC-MNT-2M</b> 172928	
		Size FS3	-	DC1, DA1, DL1	<b>DX-EMC-MNT-3M</b> 172930	

 **Information relevant for export to North America**

Product Standards	UL 508C; CSA-C22.2 No. 14; IEC/EN61800-3; IEC/EN61800-5; CE marking
UL File No.	E172143
UL Category Control No.	NMMS, NMMS7
CSA File No.	UL report applies to both US and Canada
North America Certification	UL listed, certified by UL for use in Canada
Suitable for	Branch circuits





# PowerXL™ Variable Frequency Drive DG1 General Purpose Drive

PowerXL™ DG1 general-purpose drives are variable frequency drives in Eaton's "Next-Generation" PowerXL™ series. They are specifically designed for modern, sophisticated applications:

In fact, energy-saving algorithms, high short-circuit values, and a heavy-duty design all enable them to provide maximum efficiency, safety, and reliability.

#### Performance range:

- 0.75 ... 90 kW ( $U_g$ : 3~ 230 V,  $U_2$ : 3~ 230 V)
- 0.75 ... 160 kW ( $U_g$ : 3~ 400 V,  $U_2$ : 3~ 400 V)

#### Features:

- **Ease of use:** Startup Wizard, inControl PC Tool software, four built-in applications, diagnostics, local/remote button, removable keypad with copy/paste functionality.
- **Communicative:** Modbus RTU, Modbus TCP, Ethernet IP and BacNet MS/TP Standard on each device. In addition to that extensive I/O above the standard in this device class
- **Efficiency:** Active energy control algorithm, 5% DC choke, input surge protection, EMC filter built-in
- **Rugged and reliable:** Dual rating with high (CT) and low (VT) overload capability, conformal coated boards, brake chopper circuit, durable metal power section, 50°C rating (60°C de-rating), removable keypad rated IP54
- **Global acceptance:** UL®, CE, cUL®, RoHS, C-Tick

#### Accessories:

- Communication modules (PROFIBUS, PROFINET, DeviceNet, etc.)
- I/O expansions
- External keypad
- Motor chokes
- Sine filters
- Braking resistances
- Power Xpert inControl operating software

#### Applications:

- Multi-pump applications
- HVAC
- Roller and chain conveyors
- Compressors, mills
- Production machines
- Centrifuges and extruders
- Traction drives, conveyor belts
- Sawing, drilling, dosing unit drives
- Chemical and primary industries
- Water jet cutting, crushers



System overview	44
Key to type references	45
Sizes and degree of protection	45
UL/CSA	45
Ordering	
Variable frequency drives DG1, IP21	46
Variable frequency drives DG1, IP54	48
Accessories	50

DG1

**System overview**

DG1, frame size FR1

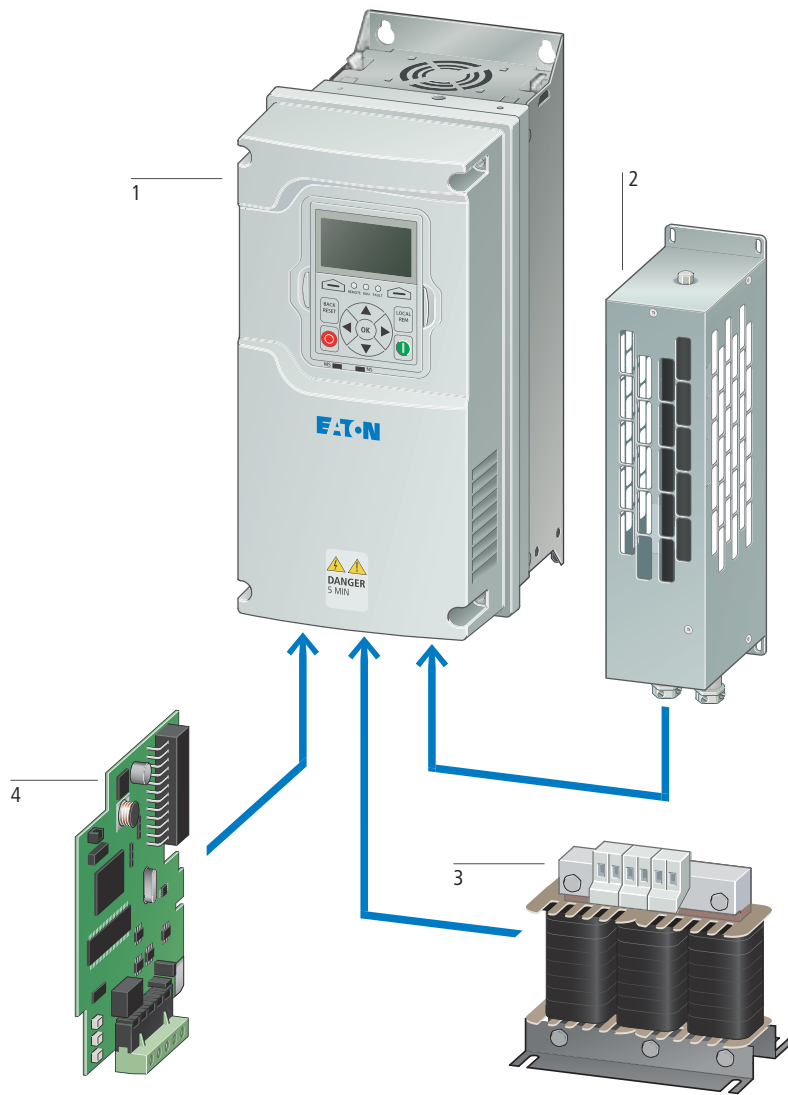

DG1 variable frequency drives 1

→ page 46

Braking resistance 2

→ page 56

Mains choke, motor choke, sine filter 3

→ page 60

Communication modules,  
expansion modules 4

→ page 56

**Key to type references**

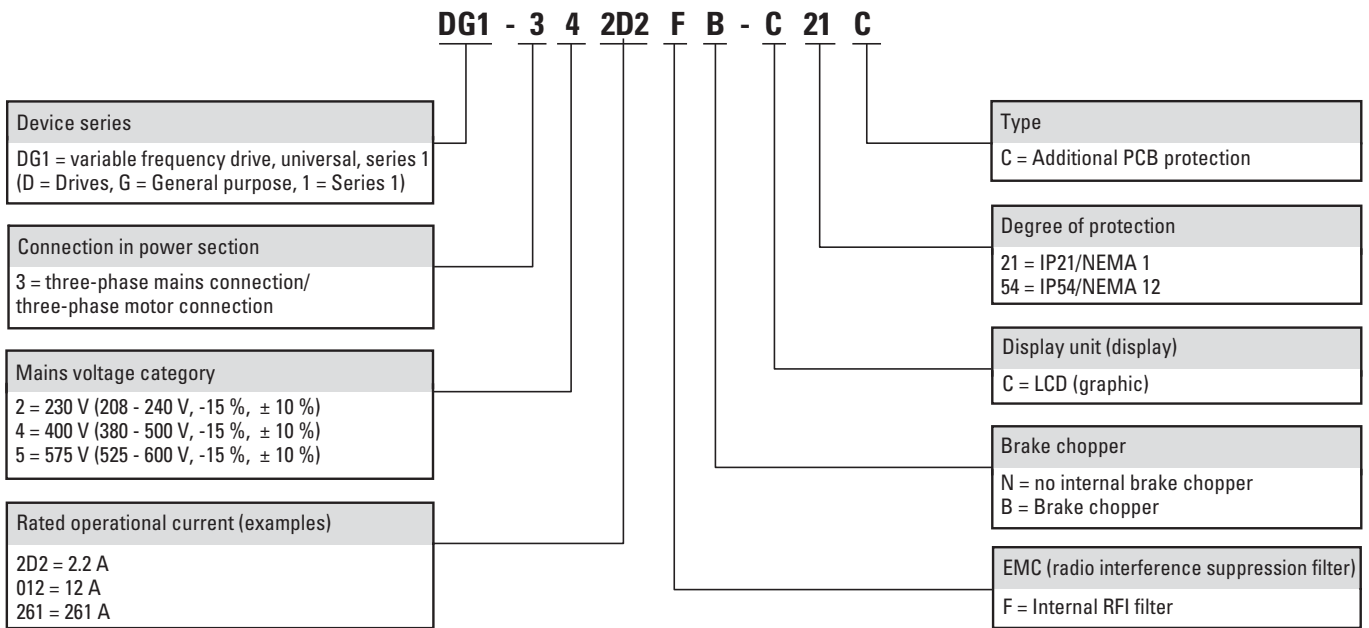

DG1

**UL/CSA**



**Information relevant for export to North America**

Product Standards	UL508C, CSA-C22.2 No. 274-13; IEC/EN61800-3; IEC/EN61800-5; CE marking
UL File No.	E134360
UL Category Control No.	NMMS, NMMS7
CSA File No.	UL report applies to both US and Canada
North America Certification	UL listed, certified by UL for use in Canada
Suitable for	Branch circuits
Max. Voltage Rating	3~ 240 V AC IEC: TN-S UL/CSA: 'Y' (Solidly Grounded Wey) 3~ 500 V AC IEC: TN-S UL/CSA: 'Y' (Solidly Grounded Wey)

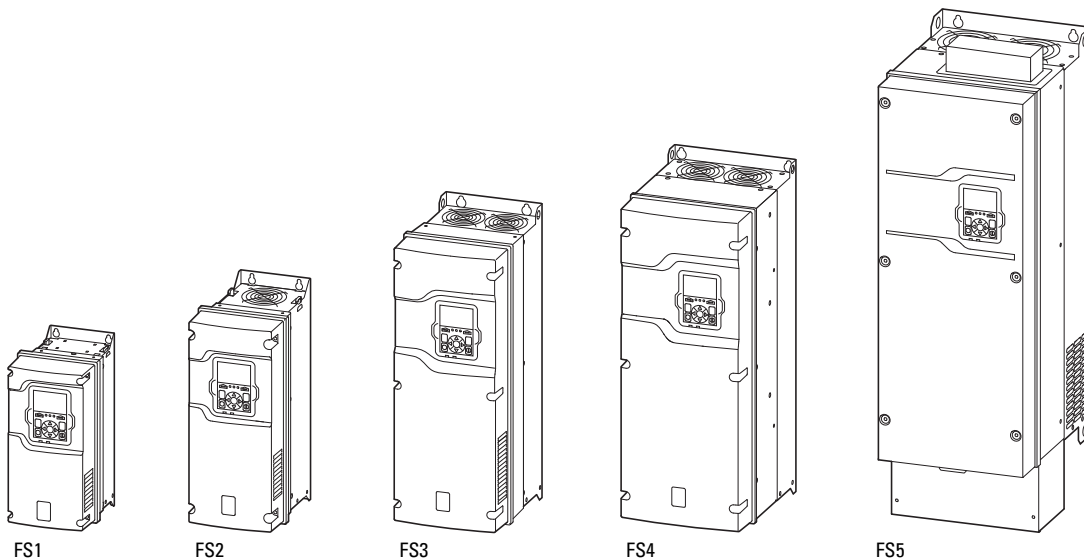
**Sizes**



Ordering



Rated operational current <sup>1)</sup>	Assigned motor rating <sup>1), 2), 3)</sup>		Rated operational current <sup>1)</sup>	Assigned motor rating <sup>1), 2), 3)</sup>		Fitted with					Frame size	Degree of Protection	Part no. Article no.	Price see price list	Std. pack
	I <sub>H</sub> = 150 % I <sub>e</sub> A	I <sub>H</sub> = 150 % P kW		I <sub>H</sub> = 150 % P HP	I <sub>L</sub> = 110 % I <sub>e</sub> A	I <sub>L</sub> = 110 % P kW	I <sub>L</sub> = 110 % P HP	Radio interference	Brake chopper	DC link choke					
U <sub>e</sub> 230 V AC, 3-phase / U <sub>2</sub> 230 V AC, 3-phase Mains voltage (50/60Hz) U <sub>LN</sub> : 208 (-15%) - 240 (+10%) V															
3.7	0.75	0.75	4.8	1.1	1	✓	✓	✓	✓	✓	FS1	IP21	DG1-323D7FB-C21C 9701-1002-00P	1 off  	
4.8	1.1	1	6.6	1.5	1.5	✓	✓	✓	✓	✓			DG1-324D8FB-C21C 9701-1004-00P		
6.6	1.5	1.5	7.8	2	2	✓	✓	✓	✓	✓			DG1-326D6FB-C21C 9701-1006-00P		
7.8		2	11		2.2	3	✓	✓	✓	✓			✓		DG1-327D8FB-C21C 9701-1008-00P
11	2.2	3	12.5	3	5	✓	✓	✓	✓	✓			DG1-32011FB-C21C 9701-1001-00P		
12.5	3	5	17.5	4		5	✓	✓	✓	✓	✓	DG1-32012FB-C21C 9701-2002-00P			
17.5	4		5	25	5.5	7.5	✓	✓	✓	✓	✓	DG1-32017FB-C21C 9701-2004-00P			
25	5.5	7.5	31	7.5	10	✓	✓	✓	✓	✓	DG1-32025FB-C21C 9701-2001-00P				
31	7.5	10	48	11	15	✓	✓	✓	✓	✓	FS3	DG1-32031FB-C21C 9701-3002-00P			
48	11	15	61	15	20	✓	✓	✓	✓	✓		DG1-32048FB-C21C 9701-3001-00P			
61	15	20	75	22	25	✓	-	✓	✓	✓	FS4	DG1-32061FN-C21C 9701-4004-00P			
75		25	88		22	30	✓	✓	✓	✓		✓	DG1-32061FB-C21C 9701-4002-00P		
88	30	30	114	30	40	✓	✓	✓	✓	✓	DG1-32075FN-C21C 9701-4008-00P				
						✓	✓	✓	✓	✓	DG1-32075FB-C21C 9701-4006-00P				
114	30	40	143	45	50	✓	✓	✓	✓	✓	DG1-32088FN-C21C 9701-4001-00P				
						✓	✓	✓	✓	✓	DG1-32088FB-C21C 9701-4010-00P				
143	45	50	170	60	60	✓	✓	✓	✓	✓	DG1-32114FN-C21C 9701-5004-00P				
						✓	✓	✓	✓	✓	DG1-32114FB-C21C 9701-5002-00P				
170	60	60	211	55	75	✓	✓	✓	✓	✓	FS5	DG1-32143FN-C21C 9701-5008-00P			
						✓	✓	✓	✓	✓		DG1-32143FB-C21C 9701-5006-00P			
170	60	60	211	55	75	✓	-	✓	✓	✓	DG1-32170FN-C21C 9701-5001-00P				
						✓	✓	✓	✓	✓	DG1-32170FB-C21C 9701-5010-00P				

Notes

- <sup>1)</sup> Overload cycle for 60 s every 600 s
- <sup>2)</sup> for normal internally and externally ventilated 4 pole, three-phase asynchronous motors with 1500 rpm<sup>-1</sup> at 50 Hz or 1800 min<sup>-1</sup> at 60 Hz
- <sup>3)</sup> at 230 V, 50 Hz/at 220 - 240 V, 60 Hz

  Information relevant for export to North America → Page 45



Rated operational current <sup>1)</sup>	Assigned motor rating <sup>1), 2), 3)</sup>		Rated operational current <sup>1)</sup>	Assigned motor rating <sup>1), 2), 3)</sup>		Fitted with	Frame size	Degree of Protection	Part no. Article no.	Price see price list	Std. pack
$I_H = 150\%$ $I_e$ A	$I_H = 150\%$ P kW	$I_H = 150\%$ P HP	$I_L = 110\%$ $I_e$ A	$I_L = 110\%$ P kW	$I_L = 110\%$ P HP	Radio interference Brake chopper DC link choke Multi-line graphic display Additional PCB protection					
<b>U<sub>e</sub> 400 V AC, 3-phase / U<sub>2</sub> 400 V AC, 3-phase</b> Mains voltage (50/60Hz) U <sub>LN</sub> : 380 (-15%) - 500 (+10%) V											
2.2	0.75	1	3.3	1.1	1.5	✓ ✓ ✓ ✓ ✓	FS1	IP21	<b>DG1-342D2FB-C21C</b> 9702-1002-00P		1 off  
3.3	1.1	1.5	4.3	1.5	2	✓ ✓ ✓ ✓ ✓		<b>DG1-343D3FB-C21C</b> 9702-1004-00P			
4.3	1.5	2	5.6	2.2	3	✓ ✓ ✓ ✓ ✓			<b>DG1-344D3FB-C21C</b> 9702-1006-00P		
5.6	2.2	3	7.6	3		✓ ✓ ✓ ✓ ✓			<b>DG1-345D6FB-C21C</b> 9702-1008-00P		
7.6	3		9	4	5	✓ ✓ ✓ ✓ ✓			<b>DG1-347D6FB-C21C</b> 9702-1001-00P		
9	4	5	12	5.5	7.5	✓ ✓ ✓ ✓ ✓			<b>DG1-349D0FB-C21C</b> 9702-1011-00P		
12	5.5	7.5	16	7.5	10	✓ ✓ ✓ ✓ ✓	FS2		<b>DG1-34012FB-C21C</b> 9702-2002-00P		
16	7.5	10	23	11	15	✓ ✓ ✓ ✓ ✓			<b>DG1-34016FB-C21C</b> 9702-2004-00P		
23	11	15	31	15	20	✓ ✓ ✓ ✓ ✓			<b>DG1-34023FB-C21C</b> 9702-2001-00P		
31	15	20	38	18.5	25	✓ ✓ ✓ ✓ ✓	FS3		<b>DG1-34031FB-C21C</b> 9702-3002-00P		
38	18.5	25	46	22	30	✓ ✓ ✓ ✓ ✓			<b>DG1-34038FB-C21C</b> 9702-3004-00P		
46	22	30	61	30	40	✓ ✓ ✓ ✓ ✓			<b>DG1-34046FB-C21C</b> 9702-3001-00P		
61	30	40	72	37	50	✓ ✓ ✓ ✓ ✓	FS4		<b>DG1-34061FB-C21C</b> 9702-4002-00P		
72	37	50	87	45	60	✓ - ✓ ✓ ✓ ✓ ✓ ✓ ✓ ✓			<b>DG1-34072FN-C21C</b> 9702-4008-00P		
									<b>DG1-34072FB-C21C</b> 9702-4006-00P		
87	45	60	105	55	75	✓ - ✓ ✓ ✓ ✓ ✓ ✓ ✓ ✓			<b>DG1-34087FN-C21C</b> 9702-4001-00P		
									<b>DG1-34087FB-C21C</b> 9702-4010-00P		
105	55	75	140	75	100	✓ - ✓ ✓ ✓ ✓ ✓ ✓ ✓ ✓	FS5		<b>DG1-34105FN-C21C</b> 9702-5004-00P		
									<b>DG1-34105FB-C21C</b> 9702-5002-00P		
140	75	100	170	90	125	✓ - ✓ ✓ ✓ ✓ ✓ ✓ ✓ ✓			<b>DG1-34140FN-C21C</b> 9702-5008-00P		
									<b>DG1-34140FB-C21C</b> 9702-5006-00P		
170	90	125	205	110	150	✓ - ✓ ✓ ✓ ✓ ✓ ✓ ✓ ✓			<b>DG1-34170FN-C21C</b> 9702-5001-00P		
									<b>DG1-34170FB-C21C</b> 9702-5010-00P		

Notes

- <sup>1)</sup> Overload cycle for 60 s every 600 s
- <sup>2)</sup> for normal internally and externally ventilated 4 pole, three-phase asynchronous motors with 1500 rpm<sup>-1</sup> at 50 Hz or 1800 min<sup>-1</sup> at 60 Hz
- <sup>3)</sup> at 400 V, 50 Hz/at 440 - 480 V, 60 Hz

  Information relevant for export to North America → Page 45

DG1

Rated operational current <sup>1)</sup>	Assigned motor rating <sup>1), 2), 3)</sup>		Rated operational current <sup>1)</sup>	Assigned motor rating <sup>1), 2), 3)</sup>		Fitted with					Frame size	Degree of Protection	Part no. Article no.	Price see price list	Std. pack	
$I_H = 150\%$ $I_e$ A	$I_H = 150\%$ P kW	$I_H = 150\%$ P HP	$I_L = 110\%$ $I_e$ A	$I_L = 110\%$ P kW	$I_L = 110\%$ P HP	Radio interference suppression filter	Brake chopper	DC link choke	Multi-line graphic display	Additional PCB protection						
<b>U<sub>e</sub> 230 V AC, 3-phase / U<sub>2</sub> 230 V AC, 3-phase</b> Mains voltage (50/60Hz) U <sub>LN</sub> : 208 (-15%) - 240 (+10%) V																
3.7	0.75	0.75	4.8	1.1	1	✓	✓	✓	✓	✓	FS1	IP54	<b>DG1-323D7FB-C54C</b> 9701-1101-00P		1 off 	
4.8	1.1	1	6.6	1.5	1.5	✓	✓	✓	✓	✓			<b>DG1-324D8FB-C54C</b> 9701-1103-00P			
6.6	1.5	1.5	7.8		2	✓	✓	✓	✓	✓			<b>DG1-326D6FB-C54C</b> 9701-1105-00P			
7.8	1.5	2	11	2.2	3	✓	✓	✓	✓	✓			<b>DG1-327D8FB-C54C</b> 9701-1107-00P			
11	2.2	3	12.5	3		✓	✓	✓	✓	✓			<b>DG1-32011FB-C54C</b> 9701-1109-00P			
12.5	3		17.5	4	5	✓	✓	✓	✓	✓	FS2		<b>DG1-32012FB-C54C</b> 9701-2101-00P			
17.5	4	5	25	5.5	7.5	✓	✓	✓	✓	✓			<b>DG1-32017FB-C54C</b> 9701-2103-00P			
25	5.5	7.5	31	7.5	10	✓	✓	✓	✓	✓			<b>DG1-32025FB-C54C</b> 9701-2105-00P			
31	7.5	10	48	11	15	✓	✓	✓	✓	✓	FS3		<b>DG1-32031FB-C54C</b> 9701-3101-00P			
48	11	15	61	15	20	✓	✓	✓	✓	✓			<b>DG1-32048FB-C54C</b> 9701-3103-00P			
61	15	20	75	22	25	✓	-	✓	✓	✓	FS4		<b>DG1-32061FN-C54C</b> 9701-4103-00P			
						✓	✓	✓	✓	✓			<b>DG1-32061FB-C54C</b> 9701-4101-00P			
75	22	25	88		30	✓	-	✓	✓	✓			<b>DG1-32075FN-C54C</b> 9701-4107-00P			
						✓	-	✓	✓	✓			<b>DG1-32075FB-C54C</b> 9701-4105-00P			
88		30	114	30	40	✓	-	✓	✓	✓			<b>DG1-32088FN-C54C</b> 9701-4111-00P			
						✓	-	✓	✓	✓			<b>DG1-32088FB-C54C</b> 9701-4109-00P			
114	30	40	143	45	50	✓	-	✓	✓	✓			<b>DG1-32114FN-C54C</b> 9701-5103-00P			
						✓	-	✓	✓	✓			<b>DG1-32114FB-C54C</b> 9701-5101-00P			
143	45	50	170		60	✓	-	✓	✓	✓	FS5		<b>DG1-32143FN-C54C</b> 9701-5107-00P			
						✓	-	✓	✓	✓			<b>DG1-32143FB-C54C</b> 9701-5105-00P			
170		60	211	55	75	✓	-	✓	✓	✓			<b>DG1-32170FN-C54C</b> 9701-5111-00P			
						✓	✓	✓	✓	✓			<b>DG1-32170FB-C54C</b> 9701-5109-00P			



Notes

<sup>1)</sup> Overload cycle for 60 s every 600 s

<sup>2)</sup> for normal internally and externally ventilated 4 pole, three-phase asynchronous motors with 1500 rpm<sup>-1</sup> at 50 Hz or 1800 min<sup>-1</sup> at 60 Hz



<sup>3)</sup> at 230 V, 50 Hz/at 220 - 240 V, 60 Hz

 Information relevant for export to North America → Page 45



Rated operational current <sup>1)</sup>	Assigned motor rating <sup>1), 2), 3)</sup>		Rated operational current <sup>1)</sup>	Assigned motor rating <sup>1), 2), 3)</sup>		Fitted with					Frame size	Degree of Protection	Part no. Article no.	Price see price list	Std. pack	
$I_H = 150\%$ $I_e$ A	$I_H = 150\%$ P kW	$I_H = 150\%$ P HP	$I_L = 110\%$ $I_e$ A	$I_L = 110\%$ P kW	$I_L = 110\%$ P HP	Radio interference suppression filter	Brake chopper	DC link choke	Multi-line graphic display	Additional PCB protection						
<b>U<sub>e</sub> 400 V AC, 3-phase / U<sub>2</sub> 400 V AC, 3-phase</b> Mains voltage (50/60Hz) U <sub>LN</sub> : 380 (-15%) - 500 (+10%) V																
2.2	0.75	1	3.3	1.1	1.5	✓	✓	✓	✓	✓	FS1	IP54	<b>DG1-342D2FB-C54C</b> 9702-1101-00P		1 off  	
3.3	1.1	1.5	4.3	1.5	2	✓	✓	✓	✓	✓			<b>DG1-343D3FB-C54C</b> 9702-1103-00P			
4.3	1.5	2	5.6	2.2	3	✓	✓	✓	✓	✓			<b>DG1-344D3FB-C54C</b> 9702-1105-00P			
5.6	2.2	3	7.6	3		✓	✓	✓	✓	✓			<b>DG1-345D6FB-C54C</b> 9702-1107-00P			
7.6	3		9	4	5	✓	✓	✓	✓	✓			<b>DG1-347D6FB-C54C</b> 9702-1109-00P			
9	4	5	12	5.5	7.5	✓	✓	✓	✓	✓			<b>DG1-349D0FB-C54C</b> 9702-1111-00P			
12	5.5	7.5	16	7.5	10	✓	✓	✓	✓	✓	FS2		<b>DG1-34012FB-C54C</b> 9702-2101-00P			
16	7.5	10	23	11	15	✓	✓	✓	✓	✓			<b>DG1-34016FB-C54C</b> 9702-2103-00P			
23	11	15	31	15	20	✓	✓	✓	✓	✓			<b>DG1-34023FB-C54C</b> 9702-2105-00P			
31	15	20	38	18.5	25	✓	✓	✓	✓	✓	FS3		<b>DG1-34031FB-C54C</b> 9702-3101-00P			
38	18.5	25	46	22	30	✓	✓	✓	✓	✓			<b>DG1-34038FB-C54C</b> 9702-3103-00P			
46	22	30	61	30	40	✓	✓	✓	✓	✓			<b>DG1-34046FB-C54C</b> 9702-3105-00P			
61	30	40	72	37	50	✓	✓	✓	✓	✓	FS4		<b>DG1-34061FB-C54C</b> 9702-4101-00P			
						✓	-	✓	✓	✓			<b>DG1-34061FN-C54C</b> 9702-4103-00P			
72	37	50	87	45	60	✓	-	✓	✓	✓			<b>DG1-34072FN-C54C</b> 9702-4107-00P			
						✓	✓	✓	✓	✓			<b>DG1-34072FB-C54C</b> 9702-4105-00P			
87	45	60	105	55	75	✓	-	✓	✓	✓			<b>DG1-34087FN-C54C</b> 9702-4111-00P			
						✓	✓	✓	✓	✓			<b>DG1-34087FB-C54C</b> 9702-4109-00P			
105	55	75	140	75	100	✓	-	✓	✓	✓	FS5		<b>DG1-34105FN-C54C</b> 9702-5103-00P			
						✓	✓	✓	✓	✓			<b>DG1-34105FB-C54C</b> 9702-5101-00P			
140	75	100	170	90	125	✓	-	✓	✓	✓			<b>DG1-34140FN-C54C</b> 9702-5107-00P			
						✓	✓	✓	✓	✓			<b>DG1-34140FB-C54C</b> 9702-5105-00P			
170	90	125	205	110	150	✓	-	✓	✓	✓			<b>DG1-34170FN-C54C</b> 9702-5111-00P			
						✓	✓	✓	✓	✓			<b>DG1-34170FB-C54C</b> 9702-5109-00P			

Notes

- <sup>1)</sup> Overload cycle for 60 s every 600 s
- <sup>2)</sup> for normal internally and externally ventilated 4 pole, three-phase asynchronous motors with 1500 rpm<sup>-1</sup> at 50 Hz or 1800 min<sup>-1</sup> at 60 Hz
- <sup>3)</sup> at 400 V, 50 Hz/at 440 - 480 V, 60 Hz

  Information relevant for export to North America → Page 45

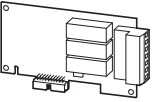
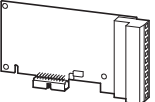
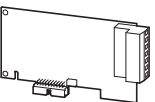
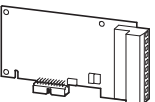
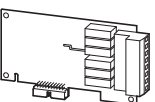
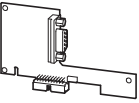
DG1

	Description	Length	For use with	Part no. Article no.	Price see price list	Std. pack
<b>External keypad</b>						
	with OLED display Front IP54 Multilingual	-	DG1	<b>DXG-KEY-LCD</b> 730-32047-00P		1 off
	Mounting frame with approx. 0.5 m-long, plug-in connection cable	0.5	DXG-KEY-LCD	<b>DXG-KEY-RMTKIT</b> 730-32033-00P		
	Mounting frame	-		<b>DXG-KEY-HOLDER</b> 730-32032-00P		
	Cover for RJ45 interface	-		<b>DXG-KEY-N12PLUG</b> 730-32038-00P		
<b>Expansion modules</b>						
	Output expansion 3 relay outputs	-	DG1	<b>DXG-EXT-3R0</b> 744-A2614-00P		1 off
	I/O expansion 3 digital inputs 3 Digital outputs 1 Thermistor input	-	DG1	<b>DXG-EXT-3DI3DO1T</b> 744-A2612-00P		
	I/O expansion 1 Analog input 2 Analog outputs	-	DG1	<b>DXG-EXT-1AI2AO</b> 744-A2613-00P		
	Input expansion Thermistor input	-	DG1	<b>DXG-EXT-THER1</b> 744-A2615-00P		
	Input expansion 240-V-AC input (electrically isolated) for 6 digital inputs	-	DG1	<b>DXG-EXT-6DI</b> 744-A2616-00P		
<b>Fieldbus modules</b>						
	PROFIBUS-DP SUB-D socket, 9-pole	-	DG1	<b>DXG-NET-PROFIBUS</b> 744-A2617-00P		1 off
	Interface converter from 9-pin SUB-D plug to 3-pin control signal terminal	-	DXG-NET-PROFIBUS	<b>DXG-MNT-PROFIBUS</b> 744-A2618-00P		

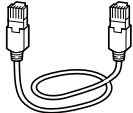
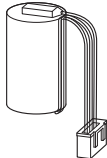
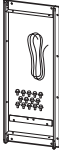
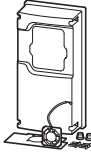
Description	Length	For use with	Part no. Article no.	Price see price list	Std. pack
<b>PC communication</b>					
parameter software	-	DG1	<b>DXG-ACC-SOFTWARE</b> 730-32036-00P		1 off
	-	DG1			
<b>Connecting cable</b>					
	Patch cord with RJ45 plugs, 8 pole	1	DG1	<b>DXG-CBL-1M0</b> 730-32034-00P	1 off
		3		<b>DXG-CBL-3M0</b> 730-32035-00P	
PC programming cable	RJ45/USB, with CD	-	DG1	<b>DXG-CBL-PCCABLE</b> 730-32037-00P	
<b>Demo case and simulator</b>					
-	DG1 simulator (control section)	-	-	<b>DG1-DEMO1</b> 178125	1 off
-	DG1 simulator	-	-	<b>DG1-DEMO2-230</b> 178126	
<b>Battery</b>					
	Battery for real-time clock	-	-	<b>DXG-ACC-RTBATT</b> 730-32039-00P	1 off
<b>mounting accessories</b>					
<b>mounting frame</b> For the power section's push-through installation outside the control panel					
	Frame parts and fixing screws	-	DG1 (frame size FS1)	<b>DXG-ACC-FR1N12FK</b> 730-32022-00P	1 off
		-	DG1 (frame size FS2)	<b>DXG-ACC-FR2N12FK</b> 730-32023-00P	
		-	DG1 (frame size FS3)	<b>DXG-ACC-FR3N12FK</b> 730-32024-00P	
		-	DG1 (frame size FS4)	<b>DXG-ACC-FR4N12FK</b> 730-32025-00P	
		-	DG1 (frame size FS5)	<b>DXG-ACC-FR5N12FK</b> 730-32026-00P	
<b>Mounting set</b> For increasing the degree of protection from IP21/NEMA 1 to IP54/NEMA 12					
	Enclosure cover with seals and extra fan	-	DG1-34... (frame size FS1, 400/480 V)	<b>DXG-ACC-4FR1N12KIT</b> 730-32029-00P	
		-	DG1 (frame size FS2)	<b>DXG-ACC-FR2N12KIT</b> 730-32030-00P	
		-	DG1 (frame size FS3)	<b>DXG-ACC-FR3N12KIT</b> 730-32031-00P	
		-	DG1-32... (frame size FS1, 230 V)	<b>DXG-ACC-2FR1N12KIT</b> 744-A2815-00P	

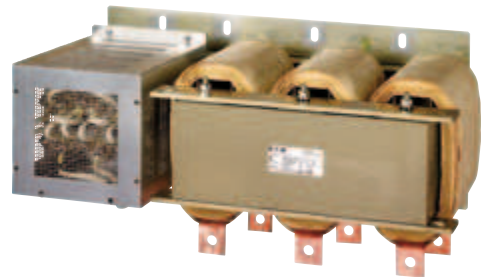
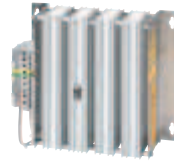

# Accessories and Engineering

With PowerXL variable speed starters and PowerXL and 9000X variable frequency drives, you can rest assured knowing that your variable-speed power drive system (PDS) needs will be well taken care of. These units are known for their compact design and wide applicability, making them the ideal choice for most applications on the global market.

But that's not all: Additional options such as mains chokes, motor chokes, sine filters, and braking resistors make it possible not only to expand the devices' range of applications, but also to adapt to a variety of EMC environments and mains-side operating conditions.

## **DX-LN... mains chokes**

DX-LN1...: single phase, max. 260 V, 50/60 Hz, 6 - 32 A

DX-LN3...: 3-phase max. 550 V, 50/60 Hz, 4 - 450 A

## **Motor choke DX-LM3...**

DX-LM3...: 3-phase, max. 750 V, 0 - 400 Hz, 5 - 450 A

## **Radio interference suppression filter DX-EMC...**

Calibrated and assigned radio interference suppression filter for Series DA1, DC1 and DL1

DX-EMC12...: single phase, with prefabricated connection cables, base-mounted filter

DX-EMC34...: 3-phase, with prefabricated connection cables, base-mounted filter, low leakage current

DX-EMC34...: 3-phase, 100 – 750 A, low leakage current

## **Sine filter DX-SIN3...**

DX-SIN3...: 3-phase, 0 – 520 V, 0 - 150 Hz, 4 - 480 A

Sine filters used with variable frequency drives require the frequency to be set to a fixed value within a range of 4 – 8 kHz.

## **DX-BR... braking resistance**

- with prefabricated connection cables for installation in DA1, DC1, and DL1 devices

- with 1-m long connection cable, temperature monitoring switch, 75 – 400 ohms, 0.4 – 1.6 kW

- with temperature monitoring switch, 2 – 100 Ohm, 0.2 – 102.4 kW



Ordering

Radio interference suppression filters	54
Braking resistances	56
Mains chokes	60
Motor chokes	60
Sine filter	61

Engineering

Components of the Power Drives Systems (PDS)	62
General information on Engineering	63
Connection examples	65
Assigned switching and protective elements	66

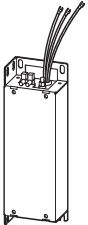
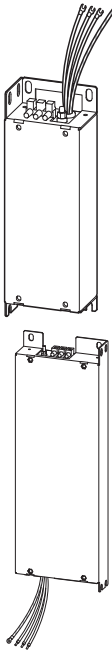
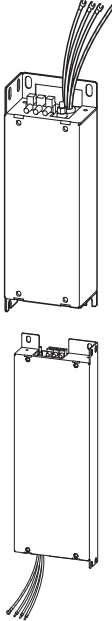
	Connection type	Rated operational current $I_e$ A	For use with <sup>1)</sup>	Degree of Protection	Part no. Article no.	Price see price list	Std. pack
<b>Radio interference suppression filters</b>							
<b>Base-mounted filter, side-mounting filter</b>							
	Single-phase, Mains voltage (50/60Hz) $U_{LN}$ [V] max. 250 + 10%	Connection terminal, PE stud, prefabricated cables	14	DC1	IP00 IP20 when connected	<b>DX-EMC12-014-FS1</b> 172273	1 off
			14	DC1, DA1			
			19	DE1			
			25	DE1, DC1			
			31	DC1			
			31	DC1			
	three-phase, Mains voltage (50/60Hz) $U_{LN}$ [V] max. 520 + 10%	Connection terminal, PE stud, prefabricated cables	8	DE1, DC1	IP00 IP20 when connected	<b>DX-EMC34-008-FS1</b> 172278	1 off
			11	DC1, DA1			
			15	DC1, DA1, DL1			
			19	DE1, DC1, DA1, DL1			
			25	DC1, DA1			
			31	DA1, DL1			
			48				
			75				
			31	DA1, DL1			
			48				
			75				
				low leakage current			
11	DC1, DA1						
15	DC1, DA1, DL1						
19	DE1, DC1, DA1, DL1						
25	DC1, DA1						
31	DA1, DL1						
48							
75							
31	DA1, DL1						
48							
75							



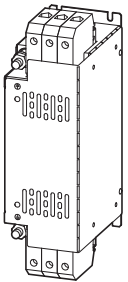

**Notes**<sup>1)</sup> See assigned switching and protective elements for an article-specific selection



	Connection type	Rated operational current $I_e$ A	For use with <sup>1)</sup>	Degree of Protection	Part no. Article no.	Price see price list	Std. pack	
<b>Radio interference suppression filters</b>								
<b>Separate mounting</b>								
	three-phase, Mains voltage (50/60Hz) $U_{LN}$ [V] max. 520 + 10%							
	Screw terminal, PE stud	100	DA1	IP20	DX-EMC34-100 172285		1 off	
		130			DX-EMC34-130 172286			
		180			DX-EMC34-180 172287			
		250			DX-EMC34-250 172288			
	Flat copper bar, PE stud	400	DA1	IP00	DX-EMC34-400 172289		1 off	
		750			DX-EMC34-750 177636			
	low leakage current	Screw terminal, PE stud	100	DA1	IP20	DX-EMC34-100-L 174611		1 off
			130			DX-EMC34-130-L 174612		
			180			DX-EMC34-180-L 174613		
250			DX-EMC34-250-L 174614					
Flat copper bar, PE stud		400	DA1	IP00	DX-EMC34-400-L 174615		1 off	
		750			DX-EMC34-750-L 177637			

**Notes**

<sup>1)</sup> See assigned switching and protective elements for an article-specific selection

	Resistance value	Continuous braking rating	Degree of Protection	For use with <sup>1)</sup>	Part no. Article no.	Price see price list	Std. pack
	R Ω	P <sub>DB</sub> kW					
<b>Braking resistances</b>							
Wire wound resistor in aluminum case for direct installation in frequency inverter enclosure of frame sizes FS2 und FS3 With prefabricated connection cable							
	100	0.2	IP54	DC1, DA1, DL1	<b>DX-BR3-100</b> 169150		1 off
Wire wound resistor in ceramic potting compound inside aluminum case for direct installation in frequency inverter enclosure of frame sizes FS4 und FS5							
	33	0.5	IP54	DA1, DL1	<b>DX-BR5-033</b> 169151		1 off
Wire wound resistor in ceramic potting compound inside aluminum case with temperature monitoring switch with connection cables (approx. 0.5 m long)							
	27	0.24	IP65	DC1, DA1, DL1, DG1, SPX	<b>DX-BR027-240</b> 174243	1 off	
	40	0.2			<b>DX-BR040-200</b> 174242		
	47	0.24			<b>DX-BR047-240</b> 174236		
	50	0.2			<b>DX-BR050-200</b> 174235		
	100	0.1			<b>DX-BR100-100</b> 174241		
	100	0.2			<b>DX-BR100-200</b> 174237		
	100	0.24			<b>DX-BR100-240</b> 174238		
	150	0.2			<b>DX-BR150-200</b> 174248		
	210	0.2			<b>DX-BR210-200</b> 174247		
430	0.1	<b>DX-BR430-100</b> 174246					

**Notes**

<sup>1)</sup> See assigned switching and protective elements for an article-specific selection



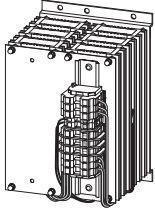

**Information relevant for export to North America**

Product Standards	UL508; C22.2
UL File No.	E300273
UL Category Control No.	NMTR2, NMTR8
CSA File No.	UL report applies to both US and Canada
North America Certification	UL listed, certified by UL for use in Canada
Suitable for	Branch circuits
Max. Voltage Rating	1000
Degree of Protection	IEC: IP00

	Resistance value	Continuous braking rating	Degree of Protection	For use with <sup>1)</sup>	Part no. Article no.	Price see price list	Std. pack
	R Ω	P <sub>DB</sub> kW					
<b>Braking resistances</b>							
Resistor combination (size 1) with temperature monitoring switch with connection terminals							
	20	0.96	IP20	DC1, DA1, DL1, DG1, SPX	<b>DX-BR020-960</b> 174257		1 off
	24	0.4			<b>DX-BR024-400</b> 174244		
	24	0.6			<b>DX-BR024-600</b> 174267		
	24	0.72			<b>DX-BR024-720</b> 174245		
	42	0.72			<b>DX-BR042-720</b> 174266		
	50	0.4			<b>DX-BR050-400</b> 174239		
	50	0.6			<b>DX-BR050-600</b> 174240		
	50	0.72			<b>DX-BR050-720</b> 174265		
	50	0.96			<b>DX-BR050-960</b> 174250		
	75	0.4			<b>DX-BR075-400</b> 174249		
	100	0.6			<b>DX-BR100-600</b> 174251		
	100	0.72			<b>DX-BR100-720</b> 174252		
	100	0.96			<b>DX-BR100-960</b> 174253		
	150	0.8			<b>DX-BR150-800</b> 174262		
	216	0.6			<b>DX-BR216-600</b> 174268		
400	0.4	<b>DX-BR400-400</b> 174261					
Resistor combination (size 2) with temperature monitoring switch with connection terminals							
	25	1.44	IP20	DC1, DA1, DL1, DG1, SPX	<b>DX-BR025-1440</b> 174258		1 off
	25	1.92			<b>DX-BR025-1920</b> 174259		
	27	2.88			<b>DX-BR027-2880</b> 174260		
	50	1.44			<b>DX-BR050-1440</b> 174254		
	50	1.92			<b>DX-BR050-1920</b> 174255		
	50	2.88			<b>DX-BR050-2880</b> 174264		
	54	2.88			<b>DX-BR054-2880</b> 174256		
	84	1.44			<b>DX-BR084-1440</b> 174263		

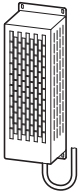

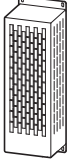
**Notes**

<sup>1)</sup> See assigned switching and protective elements for an article-specific selection

	Resistance value	Continuous braking rating	Degree of Protection	For use with <sup>1)</sup>	Part no. Article no.	Price see price list	Std. pack
	R Ω	P <sub>DB</sub> kW					
<b>Braking resistances</b>							
Wire wound resistor in ceramic potting compound inside aluminum case, combined Installed in a housing designed to prevent accidental contact and featuring a temperature monitoring switch and a 1-meter connection cable							
	75	1.1	IP20	DA1, DL1, DG1, SVX, SPX	<b>DX-BR075-1K1</b> 171917		1 off  
	100	1.1	IP20		<b>DX-BR100-1K1</b> 171896		
	100	0.8	IP20		<b>DX-BR100-0K8</b> 171907		
	100	1.6	IP20		<b>DX-BR100-1K6</b> 171924		
	150	0.5	IP20		<b>DX-BR150-0K5</b> 171916		
	150	1.1	IP20		<b>DX-BR150-1K1</b> 171895		
	200	0.8	IP20		<b>DX-BR200-0K8</b> 171894		
	200	0.4	IP20		<b>DX-BR200-0K4</b> 171915		
	400	0.4	IP20		<b>DX-BR400-0K4</b> 171914		
Wire wound resistor in ceramic potting compound inside aluminum case, combined Installed in a housing designed to prevent accidental contact and featuring a temperature monitoring switch and internal connecting terminals							
	35	1.1	IP20	DA1, DL1, DG1, SVX, SPX	<b>DX-BR035-1K1</b> 171927		1 off  
	50	0.4	IP20		<b>DX-BR050-0K4</b> 171906		
	50	9.8	IP20		<b>DX-BR050-0K8</b> 171910		
	100	0.2	IP20		<b>DX-BR100-0K2</b> 171909		
	100	0.4	IP20		<b>DX-BR100-0K4</b> 171926		

**Notes**<sup>1)</sup> See assigned switching and protective elements for an article-specific selection**Information relevant for export to North America**

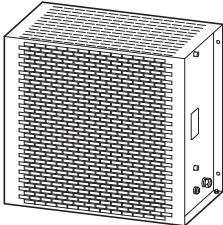
Product Standards	UL508; C22.2
UL File No.	E300273
UL Category Control No.	NMTR2, NMTR8
CSA File No.	UL report applies to both US and Canada
North America Certification	UL listed, certified by UL for use in Canada
Suitable for	Branch circuits
Max. Voltage Rating	600
Degree of Protection	IEC: IP00

Resistance value	Continuous braking rating	Degree of Protection	For use with <sup>1)</sup>	Part no. Article no.	Price see price list	Std. pack
R	P <sub>DB</sub>					
Ω	kW					
<b>Braking resistances</b>						
Steel grid resistor, combined Installed in a housing designed to prevent accidental contact and featuring a temperature monitoring switch and internal connection terminals/terminal bolts						
	2	54.3	IP20	DC1, DA1, DL1, DG1, SVX, SPX	DX-BR002-54K3	1 off  
		102.4			171923	
	6	5.1			DX-BR002-102K4	
		9.2			171903	
		18.1			DX-BR006-5K1	
		33.3			171913	
	12	3.1			DX-BR006-9K2	
		5.1			171893	
		9.2			DX-BR006-18K1	
		18.1			171922	
	22	3.1			DX-BR006-33K3	
		5.1			171902	
		9.2			DX-BR012-3K1	
		18.1			171912	
	40	1.4			DX-BR012-5K1	
		3.1			171929	
		5.1			DX-BR012-9K2	
		9.2			171921	
	47	1.4			DX-BR012-18K1	
		3.1			171901	
		5.1			DX-BR022-1K4	
		9.2			171911	
	50	3.1			DX-BR022-3K1	
		5.1			171928	
9.2		DX-BR022-5K1				
18.1		171920				
75	3.1	DX-BR022-9K2				
	5.1	171900				
	9.2	DX-BR040-3K1				
	18.1	171919				
100	3.1	DX-BR040-5K1				
	5.1	171899				
	9.2	DX-BR047-3K1				
	18.1	171908				
100	3.1	DX-BR047-5K1				
	5.1	171925				
	9.2	DX-BR047-9K2				
	18.1	171905				
100	3.1	DX-BR050-3K1				
	5.1	171918				
100	3.1	DX-BR050-5K1				
	5.1	171898				
100	5.1	DX-BR075-5K1				
	6.2	171897				
100	5.1	DX-BR100-6K2				
	6.2	171904				





**Notes**



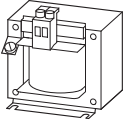
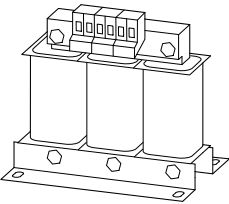

<sup>1)</sup> See assigned switching and protective elements for an article-specific selection

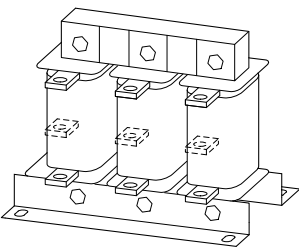
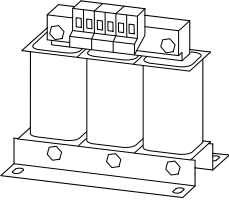
**Information relevant for export to North America**

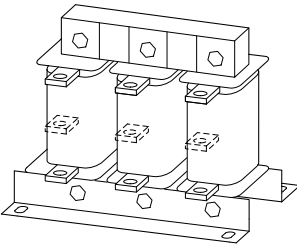

Product Standards	UL508; C22.2
UL File No.	E300273
UL Category Control No.	NMTR2, NMTR8
CSA File No.	UL report applies to both US and Canada
North America Certification	UL listed, certified by UL for use in Canada
Suitable for	Branch circuits
Max. Voltage Rating	1000
Degree of Protection	IEC: IP00

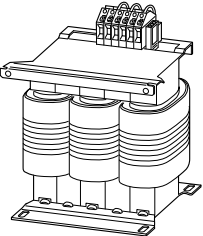
	Rated operational current $I_e$ A	Inductance L mH	Maximum heat dissipation $P_v$ W	For use with	Part no. Article no.	Price see price list	Std. pack	
<b>Mains chokes</b>								
Ambient air temperature: + 40 °C, max. 70 °C with derating								
Single-phase Max. permissible connection voltage V AC: 260 V + 0% (50/60 Hz)								
	5.8	5.05	9	DE1, DC1	<b>DX-LN1-006</b> 269490		1 off	
	8.6	3.41	11	DE1, DC1	<b>DX-LN1-009</b> 269495			
	13	2.25	12	DE1, DC1, DA1	<b>DX-LN1-013</b> 269496			
	18	1.63	17	DE1, DC1, DA1	<b>DX-LN1-018</b> 269497			
	24	1.22	20	DE1, DC1, DA1	<b>DX-LN1-024</b> 269498			
	32	0.92	24	DC1	<b>DX-LN1-032</b> 169791			
three-phase Max. permissible connection voltage V AC: 550 V + 0% (50/60 Hz)								
	3.9	7.51	17	DE1, DC1, DA1, SVX, SPX	<b>DX-LN3-004</b> 269500		1 off  	
	6	4.9	19	DE1, DC1, DA1, SVX, SPX	<b>DX-LN3-006</b> 269501			
	10	2.94	33	DE1, DC1, DA1, DL1, SVX, SPX	<b>DX-LN3-010</b> 269502			
	16	1.84	44	DE1, DC1, DA1, DL1, SVX, SPX	<b>DX-LN3-016</b> 269503			
	25	1.18	57	DC1, DA1, DL1, SVX, SPX	<b>DX-LN3-025</b> 269504			
	40	0.64	59	DA1, DL1, SVX, SPX	<b>DX-LN3-040</b> 269505			
	50	0.37	58	DA1, DL1, SVX, SPX	<b>DX-LN3-050</b> 269506			
	60	0.31	60	DA1, DL1, SVX, SPX	<b>DX-LN3-060</b> 269507			
	80	0.23	86	DA1, DL1, SVX, SPX	<b>DX-LN3-080</b> 269508			
	100	0.18	101	DA1, SVX, SPX	<b>DX-LN3-100</b> 269509			
	120	0.15	100	DA1, SVX, SPX	<b>DX-LN3-120</b> 269510			
	160	0.11	140	DA1, SVX, SPX	<b>DX-LN3-160</b> 269511			
	200	0.09	154	DA1, SVX, SPX	<b>DX-LN3-200</b> 269512			
	250	0.07	155	DA1, SVX, SPX	<b>DX-LN3-250</b> 269513			
	300	0.06	196	DA1, SVX, SPX	<b>DX-LN3-300</b> 269514			
	303	0.06	230	DA1, SVX, SPX	<b>DX-LN3-303</b> 169143			
	370	0.05	290	DA1	<b>DX-LN3-370</b> 169144			
	450	0.04	300	DA1	<b>DX-LN3-450</b> 169145			
<b>Motor chokes</b>								
Ambient air temperature: + 40 °C, max. 70 °C with derating								
three-phase Max. permissible connection voltage V AC: 750 V + 0% (0 - 400 Hz) Max. permissible pulse frequency: $f_{PWM} \leq 12$ kHz (rms)								
	5	2	24	DE1, DC1, DA1, DG1, SVX, SPX	<b>DX-LM3-005</b> 269538		1 off  	
	8	4.1	54	DE1, DC1, DA1, DG1, SVX, SPX	<b>DX-LM3-008</b> 269539			
	11	3	71	DE1, DC1, DA1, DL1, DG1, SVX, SPX	<b>DX-LM3-011</b> 269541			
	16	1.5	78	DE1, DC1, DA1, DL1, DG1, SVX, SPX	<b>DX-LM3-016</b> 269542			
	35	1	116	DC1, DA1, DL1, DG1, SVX, SPX	<b>DX-LM3-035</b> 269543			
	50	0.6	168	DA1, DL1, DG1, SVX, SPX	<b>DX-LM3-050</b> 269544			

	Rated operational current $I_e$ A	Inductance L mH	Maximum heat dissipation $P_v$ W	For use with	Part no. Article no.	Price see price list	Std. pack	
<b>Motor chokes</b>								
Ambient air temperature: + 40 °C, max. 70 °C with derating								
three-phase								
Max. permissible connection voltage V AC: 750 V + 0% (0 - 400 Hz)								
Max. permissible pulse frequency: $f_{PWM} \leq 12$ kHz (rms)								
	63	0.5	193	DA1, DL1, DG1, SVX, SPX	<b>DX-LM3-063</b> 269545		1 off 	
	80	0.5	206	DA1, DL1, DG1, SVX, SPX	<b>DX-LM3-080</b> 269546			
	100	0.45	294	DA1, DG1, SVX, SPX	<b>DX-LM3-100</b> 269547			
	150	0.35	424	DA1, DG1, SVX, SPX	<b>DX-LM3-150</b> 269548			
	180	0.3	439	DA1, DG1, SVX, SPX	<b>DX-LM3-180</b> 269549			
	220	0.2	517	DA1, SVX, SPX	<b>DX-LM3-220</b> 269560			
	260	0.15	520	DA1, SVX, SPX	<b>DX-LM3-260</b> 269561			
	303	0.15	-	DA1, SPX	<b>DX-LM3-303</b> 169146			
	370	0.12	-	DA1	<b>DX-LM3-370</b> 169147			
	450	0.1	-	DA1, SPX	<b>DX-LM3-450</b> 169148			
<b>Sine filter</b>								
Ambient air temperature: + 40 °C, max. 50 °C with derating								
three-phase								
Max. permissible connection voltage V AC: 520 V + 0% (0 - 150 Hz)								
Max. permissible pulse frequency: $f_{PWM} = \text{Constant } 4 - 8$ kHz (rms).								
	4	11	50	DC1, DA1, DG1, SVX, SPX	<b>DX-SIN3-004</b> 271538		1 off 	
	10	5.1	100	DC1, DA1, DL1, DG1, SVX, SPX	<b>DX-SIN3-010</b> 271590			
	16.5	3.07	70	DC1, DA1, DL1, DG1, SVX, SPX	<b>DX-SIN3-016</b> 271591			
	23.5	2.5	125	DC1, DA1, DL1, DG1, SVX, SPX	<b>DX-SIN3-023</b> 271593			
	32	2	100	DA1, DL1, DG1, SVX, SPX	<b>DX-SIN3-032</b> 271594			
	37	1.7	100	DG1	<b>DX-SIN3-037</b> 271595			
	48	1.2	240	DA1, DL1, DG1, SVX, SPX	<b>DX-SIN3-048</b> 271597			
	61	1	280	DA1, DL1, SVX, SPX	<b>DX-SIN3-061</b> 271599			
	72	0.95	300	DA1, DG1, SVX, SPX	<b>DX-SIN3-072</b> 271600			
	90	0.8	290	DA1, DL1, DG1, SVX, SPX	<b>DX-SIN3-090</b> 271601			
	115	0	460	DA1, DG1, SVX, SPX	<b>DX-SIN3-115</b> 271602			
	150	0.5	530	DA1, DG1, SVX, SPX	<b>DX-SIN3-150</b> 271603			
	180	0.4	500	DA1, DG1, SVX, SPX	<b>DX-SIN3-180</b> 271604			
	250	0.35	550	DA1, SVX, SPX	<b>DX-SIN3-250</b> 271605			
	440	0.14	650	DA1, SPX	<b>DX-SIN3-440</b> 271606			1 off
	480	0.14	1550	DA1	<b>DX-SIN3-480</b> 169149			1 off



**Information relevant for export to North America**

Product Standards	UL 508C; CSA-C22.2 No. 14; IEC/EN61800-3; IEC/EN61800-5; CE marking
UL File No.	DX-LN3.../DX-LM3...: E167225 DX-SIN...: E300273
UL Category Control No.	DX-LN3.../DX-LM3...: XPTQ2, XPTQ8 DX-SIN...: NMTR2, NMTR8
CSA File No.	UL report applies to both US and Canada
North America Certification	UL listed, certified by UL for use in Canada
Suitable for	Branch circuits
Max. Voltage Rating	1~ 240 V AC IEC: TN-S UL/CSA: "Y" (Solidly Grounded Wey), 3~ 240 V AC IEC: TN-

Engineering

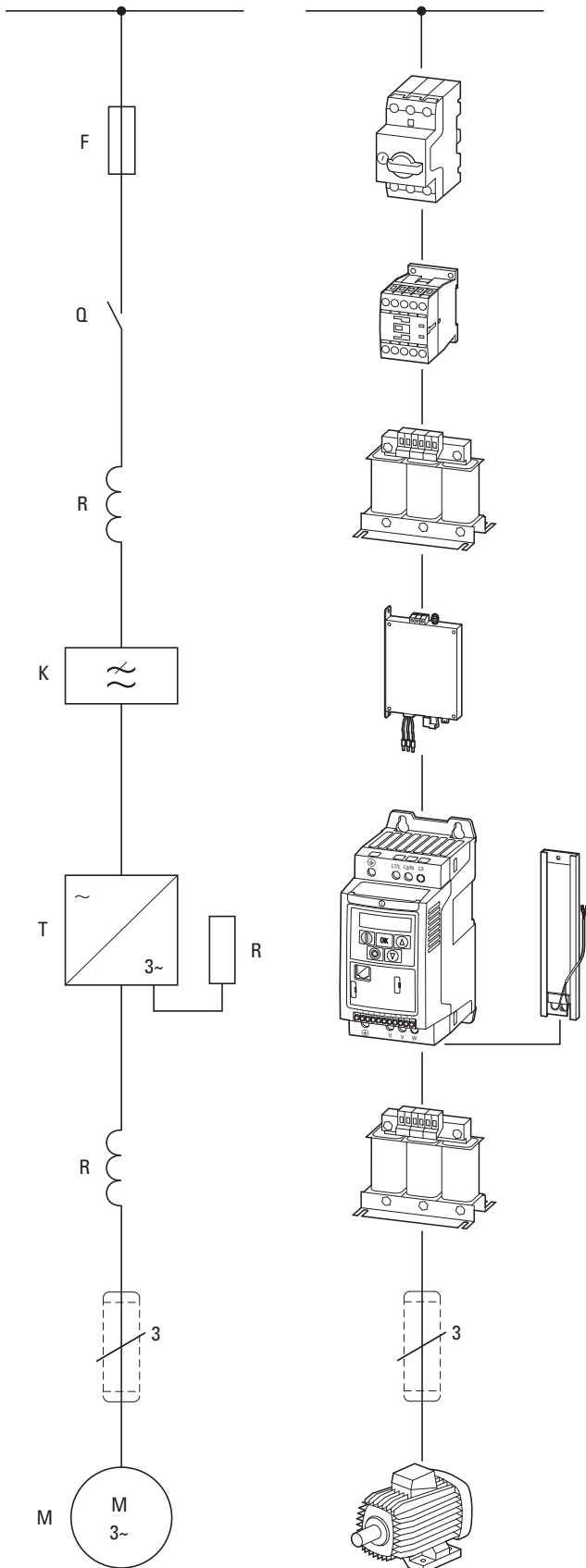

Equipment code

- F = fuses and circuit-breakers
- Q = controlled switching within energy flow (contactors, circuit-breakers)
- R = limitation (reactors, resistors)
- K = radio interference suppression filters
- T = variable-frequency drives
- M = motors

**AC supply system:** variable-frequency drives can be connected without restriction to AC supply systems with an earthed star point (TN/TT grounding systems). Directly connecting them to and running them on unbalanced or B phase-grounded systems (e.g., USA) is not permissible.

**Fuses (circuit-breakers)** enable you to protect wiring and electrical devices and appliances. For personal protection, additional AC/DC sensitive residual current circuit-breakers (RCD type B) are required.

**Contactors** serve to engage and disengage mains voltage.

**Mains chokes** damp any harmonic distortion (THD) that occurs as well as current spikes and limit inrush currents (the link capacitor's charging current). In addition, they protect the mains rectifier from voltage peaks coming from the supply mains.

**Radio interference suppression filters** damp high-frequency electromagnetic emissions from devices and appliances. They ensure that the EMC limit values for conducted interference specified in the applicable product standards are complied with (variable-frequency drives).

**Note:** External radio interference suppression filters (option) permit longer motor cables and have low leakage currents. Normally, they should only be used with variable-frequency drives that do not feature an internal radio interference suppression filter. Exception: directly assigned variable-frequency drives with internal filters (calibrated combination)

**Variable frequency drives** permit the infinitely variable speed control of three-phase motors. To do this, the variable-frequency drive converts the voltage of the AC supply system with a constant voltage and a constant frequency to a new AC voltage with a variable amplitude and a variable frequency.

A **braking resistance** converts the generator braking energy of the variable frequency drive into heat. The variable frequency drive must be equipped with a brake chopper, which connects the braking resistance parallel to the internal DC link.

**Motor chokes**

- Compensate the capacitive currents,
- Reduce current ripple and the motor's current change noise,
- Attenuate the retroaction on parallel connection of several motors.

**Sine filter**

- Smoothen the output voltage sinusoidally,
- reduce motor noise through du/dt reduction, and thereby increase the motor insulation's lifespan,
- Reduce the leakage currents to allow better motor performance at improved EMC values.

**Screened motor cables** attenuate emitted and conducted high-frequency emissions within the limit values specified in the applicable product standard (EMC). They must be connected to the earth potential on both sides across a large area (PES).

**A three-phase asynchronous motor (standard motor)** converts electrical power ( $P \sim U \times I$ ) into mechanical power ( $P \sim M \times n$ ).



**Electrical mains connection**

Variable frequency drives can be connected and operated without restriction on star-point-grounded AC supply systems (according to IEC 60364).

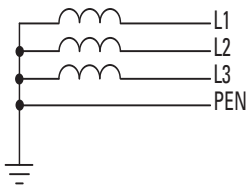
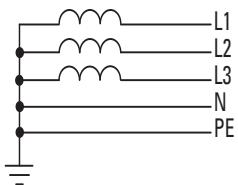

Connecting them to and operating them on asymmetrically earthed networks, such as phase-earthed delta networks (grounded delta, USA) or non-earthed or high-resistance earthed (> 30 Ω) IT networks is permitted with limitations. In these

Table: North American voltage level

Supply voltage $U_{LN}$ of the utility company	Motor voltage according to UL 508 C	Consumer voltage, rated value for the motors
120 V	110 - 120 V	115 V
240 V	220 - 240 V	230 V
400 V	440 - 480 V	460 V
600 V	550 - 600 V	575 V

**Safety and switching**

With a variable frequency drive the assignment of components on the mains side in accordance with the rated operational current at the input end  $I_{LN}$  and the utilization category AC-1.

Fuses, circuit-breakers and conductor cross-sections must meet the national and regional requirements and the required approvals at the point of operation.

To prevent fires and to protect people and farm animals from unacceptably high contact voltages, residual current devices (RCD) must be used in conjunction with a three-phase variable frequency drive, only AC/DC sensitive residual current devices (RCD, Type B) can be used.

Designation of residual current device for AC/DC-sensitive RCDs: Type B:



Earth leakage currents will be produced when using frequency-controlled drives due to the nature of the system. The main reasons for this consist of external capacitances between the phases of the motor cable, the motor cable's screening, star capacitors in the variable frequency drive, and radio interference suppression filters, as well as earthing measures at the motor's site of operation. These leakage currents can exceed 3.5 mA (AC) and/or greater than 10 mA (DC) can require improved PDS earthing as per EN 50178 (earth cable cross-

networks, only variable frequency drives without internal radio interference suppression filters (EMC) may be used. On devices with internal radio interference suppression, the ground connection of the filter must be disconnected.

The standardized rated operating voltages of the power supply (EVU) assure the following conditions at the transfer point to the consumer:

- maximum deviation from the rated value for the voltage ( $U_{LN}$ ):  $\pm 10\%$
- Maximum deviation in the voltage symmetry:  $\pm 3\%$
- Maximum deviation from the rated frequency value:  $\pm 4\%$

In reference to the lower voltage value ( $U_{LN} - 10\%$ ) the supply voltage is allowed to experience a further voltage drop of up to 4% in the consumer networks.

In ring-shaped powered network systems (e.g. in the EU), the standardized consumer voltages (230 V / 400 V / 690 V) are identical to the power supply levels of the utility companies. In star networks (for example in North America/USA), the stated consumer voltages take the voltage drop from the utility company's inflection point to the last consumer into account.

section  $\geq 10$  mm (cable cross-section of earthing wire  $\geq 10$  mm<sup>2</sup>).

**EMC compliance**

Variable frequency drives work with fast electronic switches (IGBT) in the inverter. This can cause radio interference in a magnet system, which, in turn, can adversely affect nearby electronic equipment. To provide protection from these high-frequency interference sources, these should be spatially separated and screened from frequency-controlled drives.

In Europe, compliance with the EMC directive is mandatory, and is an essential requirement for CE marking. The EMC conditions for drive systems (PDS) are described in standard IEC/EN 61800-3. This product standard considers the complete magnet system from mains-side power supply right through to the motor.

The Eaton variable frequency drive and speed starter with internal/external radio interference suppressor satisfy the requirements of the EMC product standard for the sensitive residential sector (first environment) and therefore also the higher limit values in the industrial sector (second environment).

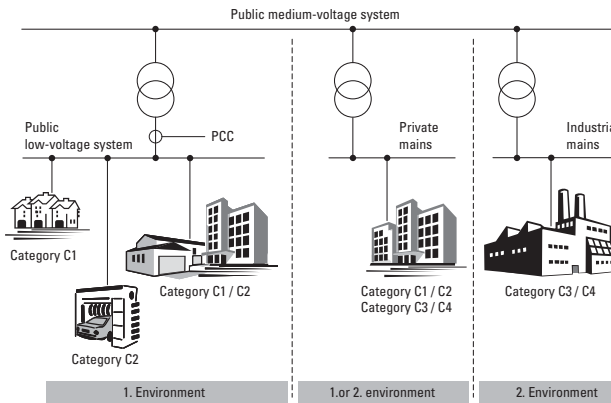

**Variable frequency drives**

A variable frequency drive is an electronic apparatus used for the variable-speed control of three-phase motors. It is intended for installation in a machine or for assembly with other components to a machine or plant. The main components of a compact design of modern variable frequency drive are a power section ① and a control section ②.

Functional actuation of the variable frequency drive and the output parameters in the power section (e.g. frequency, voltage and current) can be adjusted through:

- Control signal terminals (I/O) with analog and digital (binary) inputs,
- A keypad with function keys and display units,
- Serial interfaces (BUS) with RS485 (Modbus RTU) and optional fieldbus connections (CANopen, PROFIBUS-DP etc.) and an optional PC connection.

Internal open and closed-loop control circuits monitor all variable values in the variable frequency drive and automatically switch the process off if a value reaches a dangerous level.

① Power section with:

- A = Rectifier
- B = DC link
- C = Inverter module (IGBT)

② Control section with:

I/O = analog and binary inputs and outputs

KEYPAD = keypad with display unit

BUS = serial interfaces (RS485, fieldbus, PC interface)

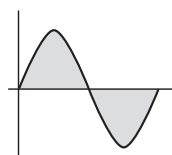
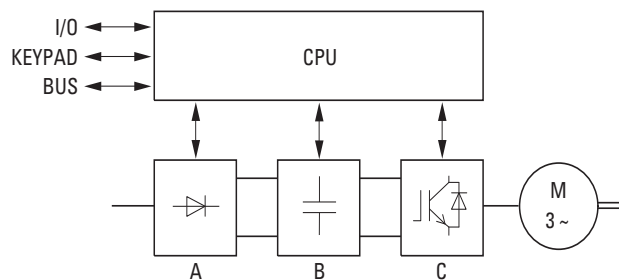
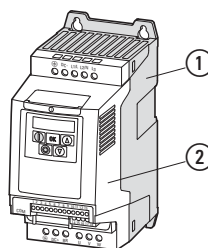

$U_{LN}$  = Phase voltage from supplying AC mains



$U_{DC}$  = DC link voltage  
 $U_{DC} = 1.41 \times U_{LN}$

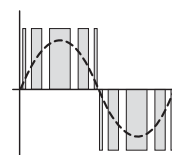

Output voltage = switched DC link voltage with sinusoidal pulse width modulation (PWM)

Block diagram with main components of a variable frequency drive

### Control methods

The IGBTs in the inverter of the variable frequency drive are controlled with sinusoidal pulse-width modulation (PWM). In real-life applications, the industry draws a distinction between the following control methods:

- Voltage frequency control (U/f control),
- V/Hz control with slip compensation
- Sensorless vector control (speed control)
- Vector control (closed-loop), speed control.

The **voltage-frequency control section** is the best known and most frequently used process. A simple characteristic curve (linear or quadratic) defines the motor's rotating field frequency and the corresponding three-phase line-to-line motor voltage is selected such that the motor is neither over nor under-magnetized.

The main applications of the U/f control section are:

- pump and fan drives,
- horizontal conveying and transportation systems,
- multiple motor drives (parallel operation of several motors at the variable frequency drive's output).

With the **U/f control section with slip compensation** the load-dependent speed change of individual drives can be compensated for (without sensors).

With **sensor-less vector control** the magnetic fields of rotor and stator are opposed to one another. With asynchronous motors the magnetic flux in the rotor must be mapped in an electronic model of the motor. This requires the input of the physical parameters of the rating plate on the motor.

In vector operation, the variable frequency drive can only control one motor at the output end. A parallel operation of several motors is not possible here. The exact calculation of the phase voltages at the variable frequency drive's output, however, improves the motor's operational behavior. The motor also heats up less in the lower speed range. The field-oriented vector control results in a significant improvement in the drive dynamics as well as optimizing performance; it also increases the range of possible applications. The main applications of sensorless vector control are:

- Material machining and processing equipment
- Condensers (compressor),
- Heavy starting duty (extruder, agitators, mixer),
- Lifting mechanisms and lifting gear (vertical movement, crane, lift).

With the **vector feedback control** the output current of the variable frequency drive acts serves a controlled variable. This makes it possible to perfectly adjust the three-phase motor in line with the corresponding torque boost. The motor speed can be controlled in connection with an rpm sensor (tachometer, pulse generator) (closed loop).

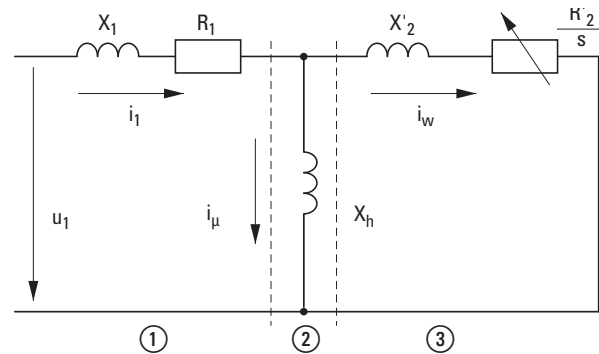

- ① Stator winding
- ② Air gap
- ③ transformed rotor winding

Simplified equivalent circuit diagram of a three-phase motor

### Motor model

Regardless of the control method used, a variable frequency drive uses the measured voltage and current values on the stator winding ( $u_1, i_1$ ) to calculate the required manipulated variable for flux-generating component  $i_\mu$  and the torque-forming magnitude in rotor  $i_w$ . The motor's load dependent slip is represented as resistor  $R'2/s$ . During no-load operation, this value approaches infinity ( $i_w \rightarrow 0$ ). On the other hand, the value approaches zero as the load increases. The current in the rotor grows at this point.

### Explanation:

EMC = Electromagnetic compatibility  
 EVU = Utility company  
 IGBT = Insulated gate bipolar transistor  
 PDS = Power drives system  
 RCD = Residual current device

### Energy-efficient drive control technology (ErP directive)

The need for energy efficiency in a PDS and legislative specifications (EC 640/2009) has been redefined by the minimum efficiency ratings of motors. From 1 January 2017, all new motors entering service with a performance range of 0.75 to 315 kW shall not be less efficient than the IE3 efficiency level or shall meet the IE2 efficiency level and be equipped with an electronic speed control (variable frequency drive, variable speed starter). Under these conditions, the following versions of three-phase motor predominate at the present time:

- Three-phase asynchronous motor (DASM),
- Permanent magnet motor (PM),
- Synchronous reluctance motor (SynRM)

Within the same efficiency class, these three motor technologies have a comparable efficiency rating at their nominal operating point. However, there are significant differences in terms of startup behavior, in part-load operation, in respect of acquisition costs and in terms of size.

The asynchronous motor functions in accordance with the familiar principle whereby the creation of magnetic fields in stator and rotor give rise to repulsion and, in response to that, to rotational movement. This motor can be started directly off the mains supply.

PM motor are synchronous motors, i.e. there is no slip between the rotational fields of rotor and stator. The magnets assure magnetization of the rotor. That reduces losses in the rotor and increases the efficiency rating, especially at low speed. For starting and operational purposes, the PM motor needs to have a variable frequency drive (DA1).

With the SynRM motor, the rotor plates have specific cut sections. These guide the magnetic lines into the interior of the rotor and generate what is known as a reluctance torque. This results in a change of magnetic resistance and is characterized from about 11 kW by a very good efficiency rating at reduced speeds that changes under load. Here too, operation without friction and optimum speed control are only assured through the use of variable frequency drives (DA1).

In principle, all three variants operate using what is known as the U/f characteristics curve but the efficiency benefits of individual technologies are only guaranteed by feedback control algorithms adapted to suit the prevailing motor technology. With algorithms of this kind, motor operation can be optimized at every operating point, even with alternating loads.

Connection example for a 0.75 kW motor

Motor: P = 0.75 kW  
 Supply system: 3/N/PE 400 V 50/60 Hz  
 Connection examples meeting EMC requirements: Power section (see figure below)

Variant A:

Motor connected in a „delta circuit“

DC1... variable frequency drive with single-phase supply conductors (230 V)

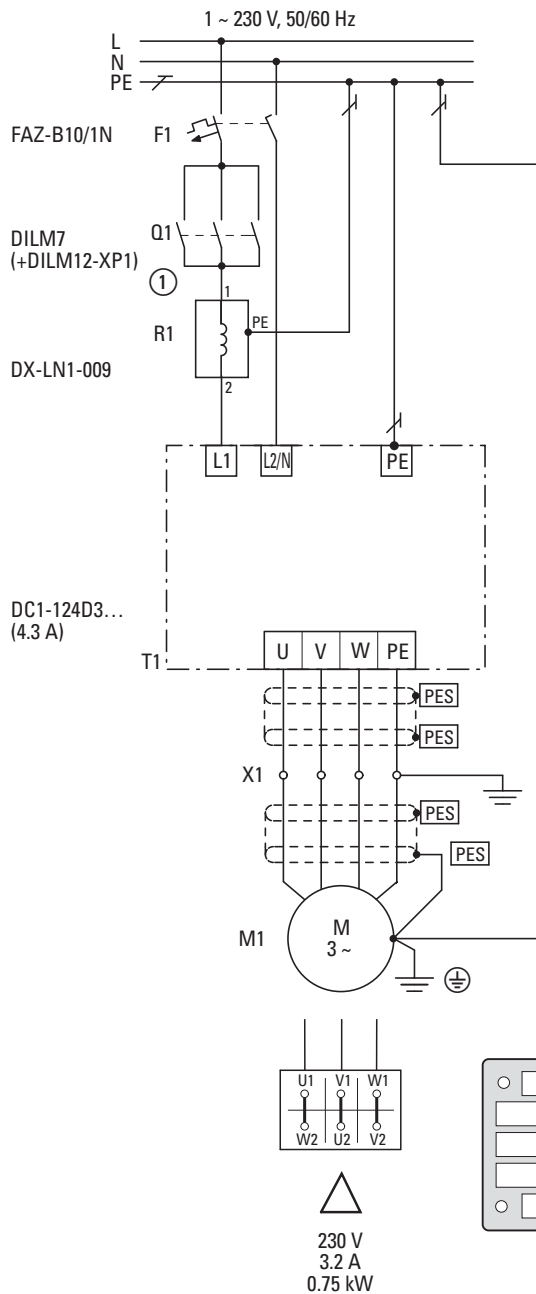

The 0.75 kW motor listed above can be connected up using a delta connection to a single-phase 230V mains supply (variant A) or in a star circuit on a 400V mains circuit (variant B).

Taking due account of the selected mains voltage, the choice of variable frequency drive can either be 230V for 1 AC (DC1-124D3...) or 400V for 3 AC (MMX34AA2D4) and type-specific accessories.

Variant B:

Motor with 'star' circuit topology

variable frequency drive DC1... with three-phase mains supply conductors (400 V)

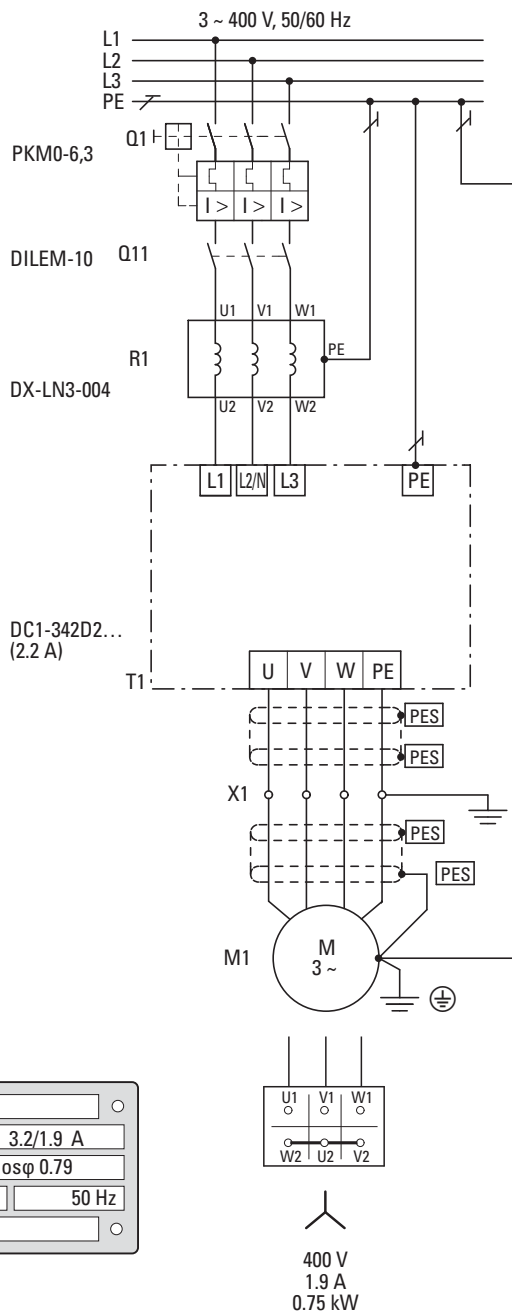

① An optional connection option for single-phase connection

Part no.	Motor Assigned motor rating <sup>1), 2)</sup> $I_H = 150\%$  P kW	Frequency inverters		Power Wiring		Mains contactor  $I_H = 150\%$ (CT/ $I_H$ , at 50 °C)	Main choke  $I_H = 150\%$
		Rated operational current <sup>1)</sup> $I_H = 150\%$  $I_e$ A	Input current $I_H = 150\%$  $I_{LN}$ A	Safety device (fuse or miniature circuit-breaker)  IEC (Typ B, gG)  UL (Class CC or J)  A			

## PowerXL™ DE1 variable speed starters

## 230 V AC, 1-phase/230 V AC, 3-phase

DE1-121D4...	0.25	1.4	3.6	FAZ-B10/1N	10	DILEM-... + P1DILEM	DX-LN1-006
DE1-122D3...	0.37	2.3	6.2	FAZ-B10/1N	10	DILEM-... + P1DILEM	DX-LN1-006
DE1-122D7...	0.55	2.7	7.3	FAZ-B10/1N	10	DILEM-... + P1DILEM	DX-LN1-009
DE1-124D3...	0.75	4.3	11.3	FAZ-B16/1N	15	DILEM-... + P1DILEM	DX-LN1-013
DE1-127D0...	1.5	7	17.4	FAZ-B20/1N	20	DILEM-... + P1DILEM	DX-LN1-018
DE1-129D6...	2.2	9.6	23.2	FAZ-B32/1N	35	DILM7-... + DILM12-XP1	DX-LN1-024

## 400 V AC, 3-phase/400 V AC, 3-phase

DE1-341D3...	0.37	1.3	1.7	FAZ-B6/3	6	DILEM-...	DX-LN3-004
DE1-342D1...	0.75	2.1	3.1	FAZ-B6/3	6	DILEM-...	DX-LN3-004
DE1-343D6...	1.5	3.6	4.9	FAZ-B6/3	6	DILEM-...	DX-LN3-006
DE1-345D0...	2.2	5	7	FAZ-B16/3	15	DILEM-...	DX-LN3-010
DE1-346D6...	3	6.6	8.5	FAZ-B16/3	15	DILEM-...	DX-LN3-010
DE1-348D5...	4	8.5	10	FAZ-B16/3	15	DILEM-...	DX-LN3-010
DE1-34011...	5.5	11.3	12	FAZ-B16/3	15	DILEM-...	DX-LN3-016
DE1-34016...	7.5	16	16.5	FAZ-B25/3	25	DILEM-...	DX-LN3-016

## PowerXL™ variable frequency drives DC1

## 115 V AC, single-phase/115 V AC, single-phase

DC1-S17D0...	0.37	7	12.4	FAZ-B16/1N	15	DILEM-... + P1DILEM	DX-LN1-013
DC1-S1011...	0.55	10.5	16.1	FAZ-B25/1N	25	DILM7-... + DILM12-XP1	DX-LN1-018

## 230 V AC, 1-phase/230 V AC, single-phase

DC1-S24D3...	0.37	4.3	6.8	FAZ-B10/1N	10	DILEM-... + P1DILEM	DX-LN1-009
DC1-S27D0...	0.75	7	12.8	FAZ-B16/1N	15	DILEM-... + P1DILEM	DX-LN1-013
DC1-S2011...	1.1	10.5	16.2	FAZ-B25/1N	25	DILM7-... + DILM12-XP1	DX-LN1-018

## 115 V AC, single-phase/230 V AC, 3-phase

DC1-1D2D3...	0.37	2.3	11	FAZ-B16/1N	15	DILEM-... + P1DILEM	DX-LN1-013
DC1-1D4D3...	0.75	4.3	19	FAZ-B25/1N	25	DILM7-... + DILM12-XP1	DX-LN1-024
DC1-1D5D8...	1.1	5.8	25	FAZ-B32/1N	35	DILM7-... + DILM12-XP1	-

## 230 V AC, 1-phase/230 V AC, 3-phase

DC1-122D3...	0.37	2.3	5	FAZ-B10/1N	10	DILM7	DX-LN1-006
DC1-124D3...	0.75	4.3	8.5	FAZ-B10/1N	10	DILM7	DX-LN1-009
DC1-127D0...	1.5	7	13.9	FAZ-B16/1N	15	DILM7	DX-LN1-018
DC1-12011...	2.2	10.5	19.5	FAZ-B25/1N	25	DILM7	DX-LN1-024
DC1-12015...	4	15	30.5	FAZ-B40/1N	50	DILM7	DX-LN1-032

## 230 V AC, 3-phase/230 V AC, 3-phase

DC1-322D3...	0.37	2.3	3	FAZ-B6/3	6	DILM7	DX-LN3-004
DC1-324D3...	0.75	4.3	4.5	FAZ-B6/3	6	DILM7	DX-LN3-006
DC1-327D0...	1.5	7	7.3	FAZ-B10/3	10	DILM7	DX-LN3-010
DC1-32011...	2.2	10.5	11	FAZ-B16/3	15	DILM7	DX-LN3-016
DC1-32018...	4	18	18.8	FAZ-B20/3	20	DILM7	DX-LN3-025

## 400 V AC, 3-phase/400 V AC, 3-phase

DC1-342D2...	0.75	2.2	2.4	FAZ-B6/3	6	DILM7	DX-LN3-004
DC1-344D1...	1.5	4.1	4.3	FAZ-B6/3	6	DILM7	DX-LN3-006
DC1-345D8...	2.2	5.8	6.1	FAZ-B10/3	10	DILM7	DX-LN3-010
DC1-349D5...	4	9.5	9.8	FAZ-B16/3	15	DILM7	DX-LN3-010
DC1-34014...	5.5	14	14.6	FAZ-B20/3	20	DILM7	DX-LN3-016
DC1-34018...	7.5	18	18.1	FAZ-B25/3	25	DILM7	DX-LN3-025
DC1-34024...	11	24	24.7	FAZ-B32/3	35	DILM17	DX-LN3-025

## Notes

<sup>1)</sup> Overload cycle for 60 s every 600 s

<sup>2)</sup> for normal internally and externally ventilated 4 pole, three-phase asynchronous motors with 1500 rpm<sup>-1</sup> at 50 Hz or 1800 min<sup>-1</sup> at 60 Hz

<sup>3)</sup> Optional external radio interference suppression filter for longer motor cable lengths and for use in different EMC environments

Power Wiring Radio interference suppression filter (external) <sup>9)</sup>	DC link connection Braking resistance		Motor feeder motor choke	
	10 % duty factor (DF)	20 % duty factor (DF)	$I_H = 150\%$ (CT/ $I_H$ , at 50 °C)	Sine filter $I_H = 150\%$ (CT/ $I_H$ , at 50 °C)

DX-EMC12-019-FS1	-	-	DX-LM3-005	-
DX-EMC12-019-FS1	-	-	DX-LM3-005	-
DX-EMC12-019-FS1	-	-	DX-LM3-005	-
DX-EMC12-019-FS1	-	-	DX-LM3-005	-
DX-EMC12-019-FS1	-	-	DX-LM3-008	-
DX-EMC12-025-FS2	-	-	DX-LM3-011	-
DX-EMC34-008-FS1...	-	-	DX-LM3-005	-
DX-EMC34-008-FS1...	-	-	DX-LM3-005	-
DX-EMC34-008-FS1...	-	-	DX-LM3-005	-
DX-EMC34-019-FS3...	-	-	DX-LM3-005	-
DX-EMC34-019-FS3...	-	-	DX-LM3-008	-
DX-EMC34-019-FS3...	-	-	DX-LM3-011	-
DX-EMC34-019-FS3...	-	-	DX-LM3-011	-
DX-EMC34-019-FS3...	-	-	DX-LM3-016	-

-	-	-	-	-
-	-	-	-	-

-	-	-	-	-
-	-	-	-	-
-	-	-	-	-

-	-	-	DX-LM3-005	DX-SIN3-004
-	-	-	DX-LM3-005	DX-SIN3-010
-	-	-	DX-LM3-008	DX-SIN3-010

DX-EMC12-014-FS1	-	-	DX-LM3-005	DX-SIN3-004
DX-EMC12-014-FS1	-	-	DX-LM3-005	DX-SIN3-010
DX-EMC12-014-FS1	-	-	DX-LM3-008	DX-SIN3-010
DX-EMC12-025-FS2	DX-BR050-0K4	DX-BR050-0K8	DX-LM3-011	DX-SIN3-016
DX-EMC12-031-FS3	DX-BR050-0K4	DX-BR050-0K8	DX-LM3-016	DX-SIN3-016

DX-EMC34-008-FS1...	-	-	DX-LM3-005	DX-SIN3-004
DX-EMC34-008-FS1...	-	-	DX-LM3-005	DX-SIN3-010
DX-EMC34-008-FS1...	-	-	DX-LM3-008	DX-SIN3-010
DX-EMC34-011-FS2...	DX-BR050-0K4	DX-BR050-0K8	DX-LM3-011	DX-SIN3-016
DX-EMC34-019-FS3...	DX-BR050-0K4	DX-BR050-0K8	DX-LM3-035	DX-SIN3-023

DX-EMC34-008-FS1...	-	-	DX-LM3-005	DX-SIN3-004
DX-EMC34-008-FS1...	-	-	DX-LM3-005	DX-SIN3-010
DX-EMC34-011-FS2...	DX-BR100-0K8	DX-BR100-1K6	DX-LM3-008	DX-SIN3-010
DX-EMC34-011-FS2...	DX-BR100-0K8	DX-BR100-1K6	DX-LM3-011	DX-SIN3-010
DX-EMC34-015-FS3...	DX-BR047-3K1	DX-BR047-5K1	DX-LM3-016	DX-SIN3-016
DX-EMC34-019-FS3...	DX-BR047-3K1	DX-BR047-5K1	DX-LM3-035	DX-SIN3-023
DX-EMC34-025-FS3...	DX-BR047-3K1	DX-BR047-5K1	DX-LM3-035	DX-SIN3-023

Part no.	Motor Assigned motor rating <sup>1), 2)</sup> $I_H = 150\%$  P kW	Frequency inverters		Power Wiring		
		Rated operational current <sup>1)</sup> $I_H = 150\%$  $I_e$ A	Input current $I_H = 150\%$  $I_{LN}$ A	Safety device (fuse or miniature circuit-breaker) IEC (Typ B, gG)	UL (Class CC or J)  A	Mains contactor $I_H = 150\%$ (CT/ $I_H$ , at 50 °C)

## PowerXL™ variable frequency drives DA1

## 230 V AC, 1-phase/230 V AC, 3-phase

DA1-124D3...	0.75	4.3	8.5	FAZ-B16/1N	16	DILM7	DX-LN1-013
DA1-127D0...	1.5	7	13.9	FAZ-B20/1N	20	DILM7	DX-LN1-018
DA1-12011...	2.2	10.5	19.5	FAZ-B25/1N	25	DILM7	DX-LN1-024

## 230 V AC, 3-phase/230 V AC, 3-phase

DA1-324D3...	0.75	4.3	4.5	FAZ-B6/3	6	DILM7	DX-LN3-006
DA1-327D0...	1.5	7	7.3	FAZ-B10/3	10	DILM7	DX-LN3-010
DA1-32011...	2.2	10.5	11	FAZ-B16/3	15	DILM7	DX-LN3-016
DA1-32018...	4	18	18.8	FAZ-B20/3	20	DILM7	DX-LN3-025
DA1-32024...	5.5	24	24.8	FAZ-B32/3	35	DILM17	DX-LN3-025
DA1-32030...	7.5	30	40	FAZ-B50/3	50	DILM17	DX-LN3-040
DA1-32046...	11	46	47.1	FAZ-B63/3	63	DILM40	DX-LN3-050
DA1-32061...	15	61	62.4	NZMC1-S80	80	DILM50	DX-LN3-080
DA1-32072...	22	72	74.1	NZMC1-S80	80	DILM65	DX-LN3-080 <sup>3)</sup>
DA1-32090...	22	90	92.3	NZMC2-S100	100	DILM80	DX-LN3-100 <sup>3)</sup>
DA1-32110...	30	110	112.7	NZMC2-S125	125	DILM95	DX-LN3-120 <sup>3)</sup>
DA1-32150...	45	150	153.5	NZMC2-S160	160	DILM150	DX-LN3-160 <sup>3)</sup>
DA1-32180...	55	180	183.8	NZMC2-S200	200	DILM170	DX-LN3-200 <sup>3)</sup>
DA1-32202...	55	202	206.2	NZMC3-S250	250	DILM185A	DX-LN3-250 <sup>3)</sup>
DA1-32248...	75	248	252.8	NZMC3-S320	320	DILM185A	DX-LN3-300 <sup>3)</sup>

## 400 V AC, 3-phase/400 V AC, 3-phase

DA1-342D2...	0.75	2.2	2.4	FAZ-B6/3	6	DILM7	DX-LN3-004
DA1-344D1...	1.5	4.1	4.3	FAZ-B6/3	6	DILM7	DX-LN3-006
DA1-345D8...	2.2	5.8	6.1	FAZ-B10/3	10	DILM7	DX-LN3-010
DA1-349D5...	4	9.5	9.8	FAZ-B16/3	15	DILM7	DX-LN3-010
DA1-34014...	5.5	14	14.6	FAZ-B20/3	20	DILM7	DX-LN3-016
DA1-34018...	7.5	18	18.1	FAZ-B25/3	25	DILM7	DX-LN3-025
DA1-34024...	11	24	24.7	FAZ-B32/3	35	DILM17	DX-LN3-025
DA1-34030...	15	30	30.8	FAZ-B40/3	40	DILM17	DX-LN3-040
DA1-34039...	18.5	39	40	FAZ-B50/3	50	DILM25	DX-LN3-040
DA1-34046...	22	46	47.1	FAZ-B63/3	63	DILM40	DX-LN3-050
DA1-34061...	30	61	62.8	NZMC1-S80	80	DILM50	DX-LN3-080 <sup>3)</sup>
DA1-34072...	37	72	73.8	NZMC1-S80	80	DILM65	DX-LN3-080 <sup>3)</sup>
DA1-34090...	45	90	92.2	NZMC1-S100	100	DILM80	DX-LN3-100 <sup>3)</sup>
DA1-34110...	55	110	112.5	NZMC2-S125	125	DILM95	DX-LN3-120 <sup>3)</sup>
DA1-34150...	75	150	153.2	NZMC2-S160	160	DILM150	DX-LN3-160 <sup>3)</sup>
DA1-34180...	90	180	183.7	NZMC2-S200	200	DILM170	DX-LN3-200 <sup>3)</sup>
DA1-34202...	110	202	205.9	NZMC3-S250	250	DILM185A	DX-LN3-250 <sup>3)</sup>
DA1-34240...	132	240	244.5	NZMC3-S320	320	DILM185A	DX-LN3-250 <sup>3)</sup>
DA1-34302...	160	302	307.8	NZMC3-S400	400	DILM225A	DX-LN3-370 <sup>3)</sup>
DA1-34370...	200	370	359	NZMC3-S400	400	DILM400	DX-LN3-370 <sup>4)</sup>
DA1-34450...	250	450	437	NZMC3-S500	500	DILM400	DX-LN3-450 <sup>4)</sup>

## Notes

<sup>1)</sup> Overload cycle for 60 s every 600 s

<sup>2)</sup> for normal internally and externally ventilated 4 pole, three-phase asynchronous motors with 1500 rpm<sup>-1</sup> at 50 Hz or 1800 min<sup>-1</sup> at 60 Hz

<sup>3)</sup> Mains choke recommended only if the power quality is poor. Current harmonics (THD) are attenuated by internal DC link chokes.

<sup>4)</sup> A mains choke ( $U_k = 1 - 4\%$ ) must be used for operation.

<sup>5)</sup> Optional external radio interference suppression filter for longer motor cable lengths and for use in different EMC environments

Power Wiring	DC link connection		Motor feeder motor choke	Sine filter
	Braking resistance			
Radio interference suppression filter (external) <sup>5)</sup>	10 % duty factor (DF)	20 % duty factor (DF)	$I_H = 150\%$ ( $CT/I_H$ , at 50 °C)	$I_H = 150\%$ ( $CT/I_H$ , at 50 °C)

-	DX-BR100-0K2	DX-BR100-0K4	DX-LM3-005	DX-SIN3-010
-	DX-BR050-0K4	DX-BR050-0K8	DX-LM3-008	DX-SIN3-010
-	DX-BR050-0K8	DX-BR035-1K1	DX-LM3-011	DX-SIN3-016

DX-EMC34-011-FS2...	DX-BR100-0K2	DX-BR100-0K4	DX-LM3-005	DX-SIN3-010
DX-EMC34-011-FS2...	DX-BR050-0K4	DX-BR050-0K8	DX-LM3-008	DX-SIN3-010
DX-EMC34-011-FS2...	DX-BR050-0K8	DX-BR035-1K1	DX-LM3-011	DX-SIN3-016
DX-EMC34-019-FS3...	DX-BR022-1K4	DX-BR022-3K1	DX-LM3-035	DX-SIN3-023
DX-EMC34-025-FS3...	DX-BR022-1K4	DX-BR022-3K1	DX-LM3-035	DX-SIN3-032
DX-EMC34-048-FS4...	DX-BR022-1K4	DX-BR022-3K1	DX-LM3-035	DX-SIN3-032
-	DX-BR022-1K4	DX-BR022-3K1	DX-LM3-050	DX-SIN3-048
-	DX-BR012-3K1	DX-BR012-5K1	DX-LM3-063	DX-SIN3-061
DX-EMC34-075-FS5...	DX-BR012-3K1	DX-BR012-5K1	DX-LM3-080	DX-SIN3-072
DX-EMC34-100...	DX-BR006-5K1	DX-BR006-9K2	DX-LM3-100	DX-SIN3-090
DX-EMC34-130...	DX-BR006-5K1	DX-BR006-9K2	DX-LM3-150	DX-SIN3-115
DX-EMC34-180...	DX-BR006-5K1	DX-BR006-9K2	DX-LM3-150	DX-SIN3-150
DX-EMC34-180...	DX-BR006-5K1	DX-BR006-9K2	DX-LM3-180	DX-SIN3-180
DX-EMC34-250...	DX-BR006-5K1	DX-BR006-9K2	DX-LM3-220	DX-SIN3-250
DX-EMC34-250...	DX-BR006-5K1	DX-BR006-9K2	DX-LM3-260	DX-SIN3-250

DX-EMC34-011-FS2...	DX-BR400-0K4	DX-BR400-0K4	DX-LM3-005	DX-SIN3-004
DX-EMC34-011-FS2...	DX-BR200-0K4	DX-BR200-0K8	DX-LM3-005	DX-SIN3-010
DX-EMC34-011-FS2...	DX-BR150-0K5	DX-BR150-1K4	DX-LM3-008	DX-SIN3-010
DX-EMC34-011-FS2...	DX-BR100-0K8	DX-BR100-1K4	DX-LM3-011	DX-SIN3-010
DX-EMC34-015-FS3...	DX-BR075-1K4	DX-BR075-5K1	DX-LM3-016	DX-SIN3-016
DX-EMC34-019-FS3...	DX-BR050-3K1	DX-BR050-5K1	DX-LM3-035	DX-SIN3-023
DX-EMC34-025-FS3...	DX-BR040-3K1	DX-BR040-5K1	DX-LM3-035	DX-SIN3-023
DX-EMC34-031-FS4...	DX-BR022-5K1	DX-BR022-9K2	DX-LM3-035	DX-SIN3-032
DX-EMC34-048-FS4...	DX-BR022-5K1	DX-BR022-9K2	DX-LM3-050	DX-SIN3-048
-	DX-BR022-5K1	DX-BR022-9K2	DX-LM3-050	DX-SIN3-048
-	DX-BR012-9K2	DX-BR012-18K1	DX-LM3-063	DX-SIN3-061
DX-EMC34-075-FS5...	DX-BR012-9K2	DX-BR012-18K1	DX-LM3-080	DX-SIN3-090
DX-EMC34-100...	DX-BR006-18K1	DX-BR006-33K3	DX-LM3-100	DX-SIN3-090
DX-EMC34-130...	DX-BR006-18K1	DX-BR006-33K3	DX-LM3-150	DX-SIN3-115
DX-EMC34-180...	DX-BR006-18K1	DX-BR006-33K3	DX-LM3-150	DX-SIN3-150
DX-EMC34-180...	DX-BR006-18K1	DX-BR006-33K3	DX-LM3-180	DX-SIN3-180
DX-EMC34-250...	DX-BR006-18K1	DX-BR006-33K3	DX-LM3-220	DX-SIN3-250
DX-EMC34-250...	DX-BR006-18K1	DX-BR006-33K3	DX-LM3-260	DX-SIN3-250
DX-EMC34-400...	DX-BR006-18K1	DX-BR006-33K3	DX-LM3-303	DX-SIN3-440
DX-EMC34-400...	DX-BR002-54K3	DX-BR002-102K4	DX-LM3-370	DX-SIN3-440
DX-EMC34-750...	DX-BR002-54K3	DX-BR002-102K4	DX-LM3-450	DX-SIN3-480

Accessories and Engineering

Part no.	Motor Assigned motor rating <sup>1), 2)</sup> $I_H = 150\%$  P kW	Frequency inverters		Power Wiring		Mains contactor $I_H = 150\%$ (CT/ $I_H$ , at 50 °C)	Main choke $I_H = 150\%$
		Rated operational current <sup>1)</sup> $I_H = 150\%$  $I_e$ A	Input current $I_H = 150\%$  $I_{LN}$ A	Safety device (fuse or miniature circuit-breaker)  IEC (Typ B, gG) <sup>3)</sup>	UL (Class CC or J) <sup>4)</sup>  A		

## PowerXL™ variable frequency drives DA1

## 500 V AC, 3-phase/500 V AC, 3-phase

Part no.	Motor rating <sup>1), 2)</sup>	Rated operational current <sup>1)</sup>	Input current	Safety device (fuse or miniature circuit-breaker)	UL (Class CC or J) <sup>4)</sup>	Mains contactor	Main choke
DA1-352D1...	1.1	2.1	2.5	6NHG000B	LPJ-6SP	DILM7	DX-LN3-004
DA1-353D1...	1.5	3.1	3.7	6NHG000B	LPJ-6SP	DILM7	DX-LN3-004
DA1-354D1...	2.2	4.1	4.9	10NHG000B	LPJ-10SP	DILM7	DX-LN3-006
DA1-356D5...	3	6.5	7.8	10NHG000B	LPJ-10SP	DILM7	DX-LN3-010
DA1-359D0...	4	9	10.8	16NHG000B	LPJ-15SP	DILM7	DX-LN3-016
DA1-35012...	5.5	12	14.4	20NHG000B	LPJ-20SP	DILM7	DX-LN3-016
DA1-35017...	7.5	17	20.6	32NHG000B	LPJ-30SP	DILM17	DX-LN3-025
DA1-35022...	11	22	26.7	40NHG000B	LPJ-35SP	DILM17	DX-LN3-040
DA1-35028...	15	28	34	50NHG000B	LPJ-45SP	DILM17	DX-LN3-040
DA1-35034...	18.5	34	41.2	63NHG000B	LPJ-60SP	DILM25	DX-LN3-050
DA1-35043...	22	43	49.5	63NHG000B	LPJ-70SP	DILM40	DX-LN3-050
DA1-35054...	30	54	62.2	80NHG000B NZMC1-S80	LPJ-80SP	DILM50	DX-LN3-080
DA1-35065...	37	65	75.8	100NHG000B NZMC1-S100	LPJ-100SP	DILM80	DX-LN3-080
DA1-35078...	45	78	90.9	125NHG000B NZMC2-S125	LPJ-125SP	DILM95	DX-LN3-100
DA1-35105...	55	105	108.2	160NHG000B NZMC2-S160	LPJ-150SP	DILM95	DX-LN3-120
DA1-35130...	75	130	127.7	160NHG000B NZMC2-S160	LPJ-175SP	DILM115	DX-LN3-160
DA1-35150...	90	150	134.8	200NHG1B NZMC2-S200	LPJ-175SP	DILM150	DX-LN3-160

## Notes

<sup>1)</sup> Overload cycle for 60 s every 600 s

<sup>2)</sup> for normal internally and externally ventilated 4 pole, three-phase asynchronous motors with 1500 rpm<sup>-1</sup> at 50 Hz or 1800 min<sup>-1</sup> at 60 Hz

<sup>3)</sup> NH fuse used together with TB00-D fuse base

<sup>4)</sup> LPJ fuse used together with J60060-3 fuse base

<sup>5)</sup> Optional external radio interference suppression filter for longer motor cable lengths and for use in different EMC environments



Power Wiring	DC link connection		Motor feeder	Sine filter
Radio interference suppression filter (external) <sup>5)</sup>	Braking resistance		motor choke	
	10 % duty factor (DF)	20 % duty factor (DF)	$I_H = 150\%$ ( $CT/I_H$ , at 50 °C)	$I_H = 150\%$ ( $CT/I_H$ , at 50 °C)

-	-	-	DX-LM3-005	SIN-0005-6-0-P
-	DX-BR400-0K4	-	DX-LM3-005	SIN-0005-6-0-P
-	DX-BR200-0K4	DX-BR200-0K8	DX-LM3-005	SIN-0005-6-0-P
-	DX-BR150-0K5	DX-BR150-1K4	DX-LM3-008	SIN-0008-6-0-P
-	DX-BR100-0K8	DX-BR100-1K4	DX-LM3-011	SIN-0014-6-0-P
-	DX-BR100-0K8	DX-BR100-1K6	DX-LM3-016	SIN-0014-6-0-P
-	DX-BR050-3K1	DX-BR050-5K1	DX-LM3-035	SIN-0023-6-0-P
-	DX-BR040-3K1	DX-BR040-5K1	DX-LM3-035	SIN-0035-6-0-P
-	DX-BR040-3K1	DX-BR040-5K1	DX-LM3-035	SIN-0035-6-0-P
-	DX-BR022-3K1	DX-BR022-5K1	DX-LM3-035	SIN-0052-6-0-P
-	DX-BR022-3K1	DX-BR022-5K1	DX-LM3-050	SIN-0052-6-0-P
-	DX-BR022-3K1	DX-BR022-5K1	DX-LM3-063	SIN-0085-6-0-P
-	DX-BR012-3K1	DX-BR012-5K1	DX-LM3-080	SIN-0085-6-0-P
-	DX-BR012-3K1	DX-BR012-5K1	DX-LM3-080	SIN-0085-6-0-P
-	DX-BR012-3K1	DX-BR012-5K1	DX-LM3-150	SIN-0122-6-0-P
-	DX-BR012-3K1	DX-BR012-9K2	DX-LM3-150	SIN-0185-6-0-P
-	DX-BR012-3K1	DX-BR012-18K1	DX-LM3-150	SIN-0185-6-0-P

Part no.	Motor		Frequency inverters				Power Wiring			
	Assigned motor rating <sup>1), 2)</sup>		Rated operational current <sup>1)</sup>		Input current		Safety device (fuse or miniature circuit-breaker)		Mains contactor	
	I <sub>H</sub> = 150 %	I <sub>L</sub> = 110 %	I <sub>H</sub> = 150 %	I <sub>L</sub> = 110 %	I <sub>H</sub> = 150 %	I <sub>L</sub> = 110 %	IEC (Typ B, gG)	UL (Class CC or J)	I <sub>H</sub> = 150 % (CT/I <sub>H</sub> , at 50 °C)	I <sub>L</sub> = 110 % (VT/I <sub>L</sub> , at 40 °C)
P	P	I <sub>e</sub>	I <sub>e</sub>	I <sub>LN</sub>	I <sub>LN</sub>		A			
kW	kW	A	A	A	T					

## PowerXL™ variable frequency drive DG1

## 230 V AC, 3-phase/230 V AC, 3-phase

DG1-323D7...	0.75	1.1	3.7	4.8	3.2	4.4	FAZ-B6/3	6	DILEM	DILEM
DG1-324D8...	1.1	1.5	4.8	6.6	4.4	6.1	FAZ-B10/3	10	DILEM	DILEM
DG1-326D6...	1.5	1.5	6.6	7.8	6.1	7.2	FAZ-B16/3	15	DILEM	DILEM
DG1-32011...	2.2	3	11	12.5	10.2	11.6	FAZ-B16/3	15	DILEM	DILEM
DG1-32012...	3	4	12.5	17.5	10.2	16.3	FAZ-B20/3	20	DILEM	DILM7
DG1-32017...	4	5.5	17.5	25	16.2	23.2	FAZ-B32/3	35	DILEM	DILM17
DG1-32025...	5.5	7.5	25	31	23.1	29	FAZ-B40/3	40	DILM17	DILM17
DG1-32031...	7.5	11	31	48	28.7	44.2	FAZ-B50/3	50	DILM17	DILM40
DG1-32048...	11	15	48	61	44.4	56	FAZ-B63/3	63	DILM40	DILM50
DG1-32061...	15	22	61	75	56.4	64.4	NZMC1-S80	80	DILM50	DILM50
DG1-32075...	22	22	75	88	69.4	78	NZMC2-S100	100	DILM72	DILM72
DG1-32114...	30	45	114	143	105.5	129	NZMC2-S160	160	DILM95	DILM115
DG1-32143...	45	45	143	170	132.3	157	NZMC2-S200	200	DILM150	DILM150

## 400 V AC, 3-phase/400 V AC, 3-phase

DG1-342D2...	0.75	1.1	2.2	3.3	2	3.1	FAZ-B6/3	6	DILEM	DILEM
DG1-343D3...	1.1	1.5	3.3	4.3	3.1	4	FAZ-B6/3	6	DILEM	DILEM
DG1-344D3...	1.5	2.2	4.3	5.6	4.1	5.2	FAZ-B10/3	10	DILEM	DILEM
DG1-345D6...	2.2	3	5.6	7.6	5.2	7.1	FAZ-B16/3	15	DILEM	DILEM
DG1-347D6...	3	4	7.6	9	7.1	8.4	FAZ-B16/3	15	DILEM	DILEM
DG1-349D0...	4	5.5	9	12	8.4	11.2	FAZ-B16/3	15	DILEM	DILEM
DG1-34012...	5.5	7.5	12	16	11.2	15	FAZ-B20/3	20	DILEM	DILEM
DG1-34016...	7.5	11	16	23	14.9	21.5	FAZ-B25/3	25	DILEM	DILM17
DG1-34023...	11	15	23	31	21.4	29	FAZ-B32/3	35	DILM17	DILM17
DG1-34031...	15	18.5	31	38	28.8	35.2	FAZ-B40/3	40	DILM17	DILM17
DG1-34038...	18.5	22	38	46	35.3	42.6	FAZ-B50/3	50	DILM17	DILM40
DG1-34046...	22	30	46	61	42.8	55.7	FAZ-B63/3	63	DILM40	DILM50
DG1-34061...	30	37	61	72	56.7	65.7	NZMC1-S80	80	DILM50	DILM50
DG1-34072...	37	45	72	87	66.9	79.4	NZMC2-S100	100	DILM65	DILM65
DG1-34087...	45	55	87	105	80.9	97	NZMC2-S125	125	DILM65	DILM95
DG1-34105...	55	75	105	140	97.6	129	NZMC2-S160	160	DILM95	DILM115
DG1-34140...	75	90	140	170	130.1	157	NZMC2-S200	200	DILM115	DILM150
DG1-34170...	90	110	170	205	158	189	NZMC3-S250	250	DILM150	DILM250

## Notes

<sup>1)</sup> Overload cycle for 60 s every 600 s

<sup>2)</sup> for normal internally and externally ventilated 4 pole, three-phase asynchronous motors with 1500 rpm<sup>-1</sup> at 50 Hz or 1800 min<sup>-1</sup> at 60 Hz

<sup>3)</sup> Optional external radio interference suppression filter for longer motor cable lengths and for use in different EMC environments

DC link connection			Motor feeder		Sine filter	
Braking resistance			motor choke			
10 % duty factor (DF)	20 % duty factor (DF)	40 % duty factor (DF)	$I_H = 150\%$ ( $CT/I_H$ , at 50 °C)	$I_L = 110\%$ ( $VT/I_L$ , at 40 °C)	$I_H = 150\%$ ( $CT/I_H$ , at 50 °C)	$I_L = 110\%$ ( $VT/I_L$ , at 40 °C)

2 x DX-BR035-1K1	DX-BR022-3K1	DX-BR022-5K1	DX-LM3-005	DX-LM3-005	DX-SIN3-004	DX-SIN3-010
2 x DX-BR035-1K1	DX-BR022-3K1	DX-BR022-5K1	DX-LM3-005	DX-LM3-008	DX-SIN3-010	DX-SIN3-010
2 x DX-BR035-1K1	DX-BR022-3K1	DX-BR022-5K1	DX-LM3-008	DX-LM3-008	DX-SIN3-010	DX-SIN3-010
2 x DX-BR035-1K1	DX-BR022-3K1	DX-BR022-5K1	DX-LM3-016	DX-LM3-011	DX-SIN3-016	DX-SIN3-016
DX-BR012-3K1	DX-BR012-5K1	DX-BR012-9K2	DX-LM3-016	-	DX-SIN3-016	DX-SIN3-023
DX-BR012-3K1	DX-BR012-5K1	DX-BR012-9K2	DX-LM3-035	-	DX-SIN3-023	DX-SIN3-032
DX-BR012-3K1	DX-BR012-5K1	DX-BR012-9K2	DX-LM3-035	-	DX-SIN3-032	DX-SIN3-032
DX-BR012-3K1	DX-BR012-9K2	DX-BR012-18K1	DX-LM3-035	-	DX-SIN3-032	DX-SIN3-061
DX-BR012-3K1	DX-BR012-9K2	DX-BR012-18K1	DX-LM3-050	-	DX-SIN3-048	DX-SIN3-072
-	-	-	DX-LM3-063	DX-LM3-080	DX-SIN3-072	DX-SIN3-072
-	-	-	DX-LM3-080	DX-LM3-100	DX-SIN3-090	DX-SIN3-090
-	-	-	DX-LM3-150	DX-LM3-150	DX-SIN3-115	DX-SIN3-150
-	-	-	DX-LM3-150	DX-LM3-180	DX-SIN3-150	DX-SIN3-180

DX-BR040-3K1	DX-BR040-5K1	DX-BR047-9K2	DX-LM3-005	DX-LM3-005	DX-SIN3-004	DX-SIN3-004
DX-BR040-3K1	DX-BR040-5K1	DX-BR047-9K2	DX-LM3-005	DX-LM3-005	DX-SIN3-004	DX-SIN3-010
DX-BR040-3K1	DX-BR040-5K1	DX-BR047-9K2	DX-LM3-005	DX-LM3-005	DX-SIN3-010	DX-SIN3-010
DX-BR040-3K1	DX-BR040-5K1	DX-BR047-9K2	DX-LM3-008	DX-LM3-008	DX-SIN3-010	DX-SIN3-010
DX-BR040-3K1	DX-BR040-5K1	DX-BR047-9K2	DX-LM3-008	DX-LM3-011	DX-SIN3-010	DX-SIN3-010
DX-BR040-3K1	DX-BR040-5K1	DX-BR047-9K2	DX-LM3-011	DX-LM3-016	DX-SIN3-010	DX-SIN3-016
DX-BR022-5K1	DX-BR022-9K2	2 x DX-BR047-9K2	DX-LM3-016	DX-LM3-016	DX-SIN3-016	DX-SIN3-016
DX-BR022-5K1	DX-BR022-9K2	2 x DX-BR047-9K2	DX-LM3-016	DX-LM3-035	DX-SIN3-016	DX-SIN3-023
DX-BR022-5K1	DX-BR022-9K2	2 x DX-BR047-9K2	DX-LM3-035	DX-LM3-035	DX-SIN3-023	DX-SIN3-032
DX-BR022-9K2	2 x DX-BR047-9K2	-	DX-LM3-035	DX-LM3-050	DX-SIN3-032	DX-SIN3-037
DX-BR022-9K2	2 x DX-BR047-9K2	-	DX-LM3-050	DX-LM3-050	DX-SIN3-037	DX-SIN3-048
DX-BR022-9K2	2 x DX-BR047-9K2	-	DX-LM3-050	DX-LM3-063	DX-SIN3-048	DX-SIN3-072
2 x DX-BR006-18K1	2 x DX-BR006-33K3	-	DX-LM3-063	DX-LM3-080	DX-SIN3-072	DX-SIN3-072
-	-	-	DX-LM3-080	DX-LM3-100	DX-SIN3-072	DX-SIN3-090
-	-	-	DX-LM3-100	DX-LM3-150	DX-SIN3-090	DX-SIN3-115
-	-	-	DX-LM3-150	DX-LM3-150	DX-SIN3-115	DX-SIN3-150
-	-	-	DX-LM3-150	DX-LM3-180	DX-SIN3-150	DX-SIN3-180
-	-	-	DX-LM3-180	DX-LM3-260	DX-SIN3-180	DX-SIN3-250



# 9000X SVX, SPX variable frequency drive

9000X variable frequency drives are perfect for applications that require only the best. The SVX series of standard variable frequency drives is designed to easily meet the needs of simple and complex motor controllers in the industrial machine-building industry, while the SPX series of special-purpose variable frequency drives is ideal for sophisticated, high-performance applications. Whether run in open-loop or closed-loop mode, their vector control ensures reliable and dynamically responsive motor control for three-phase induction and PM motors.

## **SVX variable frequency drive**

Variable frequency drives for operation with two overload profiles: 150% or 110%. The compact enclosures are available in IP21 (NEMA 1) and IP54 (NEMA 12) versions and feature an integrated radio interference suppression filter. A braking chopper is always integrated in frame sizes of up to FR6, and there are two types available.

SVX...-4A...:  $U_{IN}$  3~400 V/ $U_{OUT}$  3~400 V, allocated motor outputs 0.75 – 132 kW

SVX...-5A...:  $U_{IN}$  3~690 V/ $U_{OUT}$  3~690 V, allocated motor outputs 2.2 – 160 kW

## **SPX variable frequency drive**

Variable frequency drives for operation with two overload profiles of 150% and 110%. The enclosures for these compact devices are available in versions with an IP21 (NEMA 1) or IP54 (NEMA 12) degree of protection and feature an integrated radio interference suppression filter. A braking chopper is always integrated in frame sizes of up to FR6, and there are two types available.

SPX...-4A...:  $U_{IN}$  3~400 V/ $U_{OUT}$  3~400 V, allocated motor outputs 0.75 – 1200 kW

SPX...-5A...:  $U_{IN}$  3~690 V/ $U_{OUT}$  3~690 V, allocated motor outputs 2.2 – 2000 kW



#### Description

Variable frequency drive SVX, SPX	76
-----------------------------------	----

#### Key to type references, UL/CSA

Variable frequency drive SVX, SPX	77
-----------------------------------	----

#### Ordering

Variable frequency drive SVX, IP21	78
------------------------------------	----

Variable frequency drive SVX, IP54	81
------------------------------------	----

Variable frequency drive SPX, IP00/IP21	84
---	----

Variable frequency drive SPX, IP54	88
------------------------------------	----

Accessories	91
-------------	----

Mains chokes, Motor chokes, Sine filter	60
---	----

#### Engineering

Assigned switching and protective elements	94
--	----

## Description

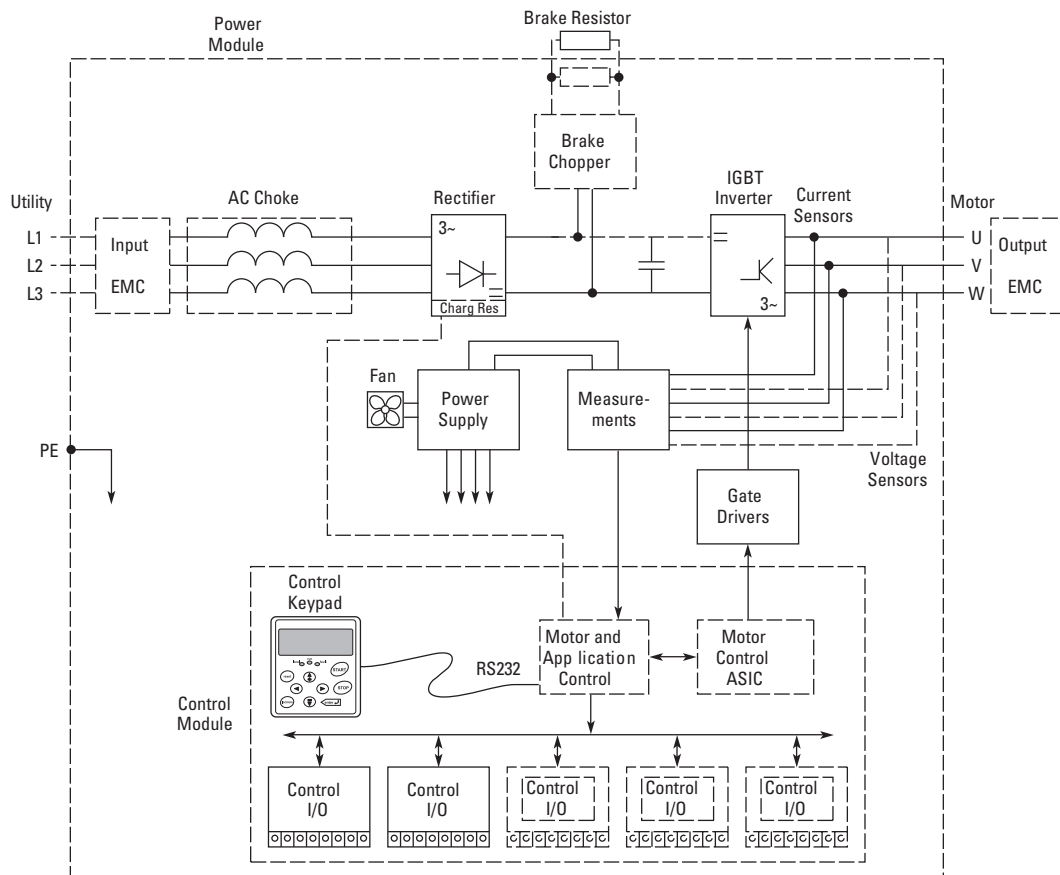

### SVX variable frequency drive

SVX units are heavy-duty, all-purpose standard variable frequency drives. Featuring a variety of application settings, they can be configured to meet virtually any challenge that arises when used to control induction motors, including applications involving multiple motors or multiple pumps run in parallel. SVX variable frequency drives are suitable for all standard applications in machines, buildings, and industrial projects. One of the factors contributing to this is their sturdy design, which features integrated chokes and EMC filters and provides effective protection against interference from the grid. In addition, their sophisticated motor control design and effective protection features for both motor and variable frequency drive guarantee reliable operation.

### Essential features

- Performance range:
  - 0.75 - 132 kW ( $U_{IN}$ : 3~ 400 V /  $U_{OUT}$ : 3~ 400 V)
  - 2.2 - 160 kW ( $U_{IN}$ : 3~ 690 V /  $U_{OUT}$ : 3~ 690 V)
- High load capacity:
  - H = 2x rated operational current (2 seconds/20 seconds) and 150% overload (60 seconds/600 seconds)
  - L = 2x rated operational current (2 seconds/20 seconds) and 110% overload (60 seconds/600 seconds)
- Ambient air temperature: -10 °C up to +50 °C without derating
- Degree of protection with compact design: IP21 (NEMA1) and IP54 (NEMA12)
- I/O expansion with plug-in modules (5 slots)
- Optional fieldbus connection (CANopen, PROFIBUS-DP, DeviceNet), LonWorks
- PID control and power factor correction (PFC) for 1 to 5 pumps
- Programmable start and application wizard for an easy parameter configuration process
- Multiple display (multi-monitoring) for monitoring up to 3 different readings at the same time
- V/Hz control with boost and slip compensation
- Dynamic open-loop and closed-loop vector control
- Internal braking chopper available in sizes of up to FR9 (compact design)

### SPX variable frequency drive

SPX variable frequency drives are the perfect choice when it comes to demanding applications in which reliability, a highly dynamic response, precision, and power are a must. Popular applications include lifting equipment and conveyances (cranes, winches, elevators, lifts), compressors and oil pumps, chippers, crushers, mixers, extruders, take-up and pay-off units, and tunnel boring machines. Multi-purpose SPX variable frequency drives are designed to cover a wide variety of applications while keeping things simple. In fact, with their excellent flexibility, they make it easy to adapt to additional process requirements for custom and complex applications used to control induction and permanent magnet motors. On top of this, their sturdy design, which features integrated chokes and EMC filters, provides effective protection against interference from the grid. Finally, their sophisticated motor control design and effective protection features for both motor and variable frequency drive guarantee reliable operation.

### Essential features

- Performance range:
  - 0.75 - 132 kW ( $U_{IN}$ : 3~ 400 V /  $U_{OUT}$ : 3~ 400 V)
  - 2.2 - 160 kW ( $U_{IN}$ : 3~ 690 V /  $U_{OUT}$ : 3~ 690 V)
- Expanded performance range with distributed design (IP00). Please enquire:
  - up to 1100 kW ( $U_{IN}$ : 3~ 400 V /  $U_{OUT}$ : 3~ 400 V)
  - up to 2000 kW ( $U_{IN}$ : 3~ 690 V /  $U_{OUT}$ : 3~ 690 V)
- High load capacity:
  - H = 2x rated operational current (2 seconds/20 seconds) and 150% overload (60 seconds/600 seconds)
  - L = 2x rated operational current (2 seconds/20 seconds) and 110% overload (60 seconds/600 seconds)
- Ambient air temperature: -10 °C up to +50 °C without derating
- Degree of protection with compact design: Up to 132/160 kW: IP21 (NEMA1) and IP54 (NEMA12)
- I/O expansion with plug-in modules (5 slots)
- Optional fieldbus connection (CANopen, PROFIBUS-DP, DeviceNet), LonWorks
- PID control and power factor correction (PFC)
- Direct and parallel circuit solutions, even for PM motors with high outputs
- Programmable start and application wizard for an easy parameter configuration process
- Multiple display (multi-monitoring) for monitoring up to 3 different readings at the same time
- V/Hz control with boost and slip compensation
- Dynamic open-loop and closed-loop vector control
- Internal braking chopper available in sizes up to FR9

**Key to type references**

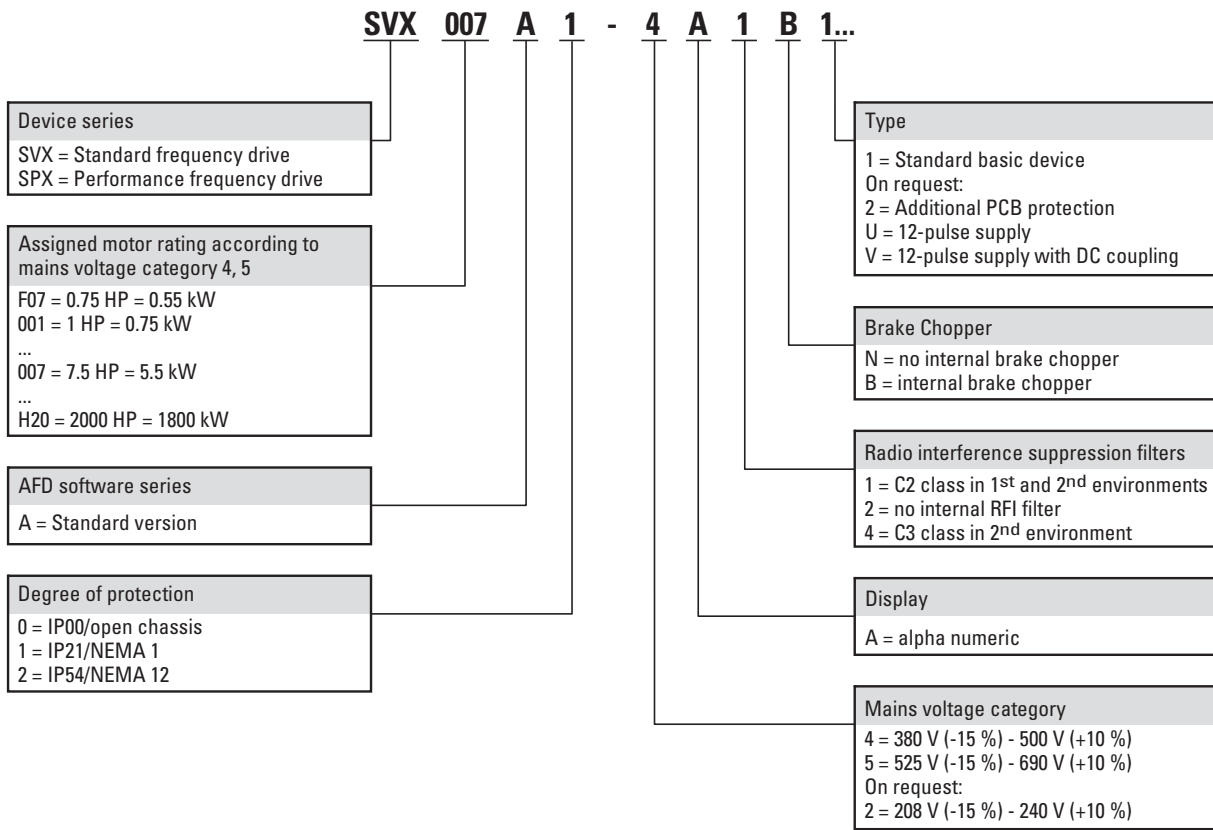

**UL/CSA**

**Information relevant for export to North America**



Product Standards	UL 508C; CSA-C22.2 No. 14; IEC/EN61800-3; IEC/EN61800-5; CE marking
UL File No.	E134360
UL Category Control No.	NMMS, NMMS2, NMMS7, NMMS8
CSA File No.	UL report applies to both US and Canada
CSA Class No.	3211-06
North America Certification	UL listed, certified by UL for use in Canada
Specially designed for North America	No
Suitable for	Branch circuits
Max. Voltage Rating	
SVX/SPX...-4...	3~ 480 V AC IEC: TN-S UL/CSA: "Y" (Solidly Grounded Wey)
SVX/SPX...-5...	3~ 690 V AC IEC: TN-S UL/CSA: "Y" (Solidly Grounded Wey)
Degree of Protection	
SPX...A0...	IEC: IP00
SVX/SPX...A1...	IEC: IP21
SVX/SPX...A2...	IEC: IP54

## Ordering

Rated operational current <sup>1)</sup>	Assigned motor rating <sup>1), 2), 3)</sup>		Rated operational current <sup>1)</sup>	Assigned motor rating <sup>1), 2), 3)</sup>		Fitted with		Frame size	Degree of Protection	Part no. Article no.	Price see price list	Std. pack
	I <sub>H</sub> = 150 % I <sub>e</sub> A	I <sub>H</sub> = 150 % P kW		I <sub>H</sub> = 150 % P HP	I <sub>L</sub> = 110 % I <sub>e</sub> A	I <sub>L</sub> = 110 % P kW	I <sub>L</sub> = 110 % P HP					
U <sub>e</sub> 400 V AC, 3-phase / U <sub>2</sub> 400 V AC, 3-phase Mains voltage (50/60Hz) U <sub>LN</sub> : 380 (-15%) - 500 (+10%) V												
2.2	0.75	1	3.3	1.1	1.5	✓	✓	FR4	IP21	SVX001A1-4A1B1 125676		1 off 
3.3	1.1	1.5	4.3	1.5	2	✓	✓			SVXF15A1-4A1B1 125707		
4.3	1.5	2	5.6	2.2	3	✓	✓			SVX002A1-4A1B1 125748		
5.6	2.2	3	7.6	3	5	✓	✓			SVX003A1-4A1B1 125679		
7.6	3	5	9	4	6	✓	✓			SVX005A1-4A1B1 125749		
9	4	6	12	5.5	7.5	✓	✓			SVX006A1-4A1B1 125682		
12	5.5	7.5	16	7.5	10	✓	✓	FR5		SVX007A1-4A1B1 125684		
16	7.5	10	23	11	15	✓	✓			SVX010A1-4A1B1 125686		
23	11	15	31	15	20	✓	✓			SVX015A1-4A1B1 125688		
31	15	20	38	18.5	25	✓	✓	FR6		SVX020A1-4A1B1 125690		
38	18.5	25	46	22	30	✓	✓			SVX025A1-4A1B1 125691		
46	22	30	61	30	40	✓	✓	FR7		SVX030A1-4A1B1 125693		
61	30	40	72	37	50	✓	-			SVX040A1-4A1N1 125695		
						✓	✓			SVX040A1-4A1B1 132656		
72	37	50	87	45	60	✓	✓			SVX050A1-4A1B1 138430		
						✓	-			SVX050A1-4A1N1 125750		
87	45	60	105	55	75	✓	✓			SVX060A1-4A1B1 138431		
						✓	-	SVX060A1-4A1N1 125751				
105	55	75	140	75	100	✓	-	FR8		SVX075A1-4A1N1 125699		
						✓	✓			SVX075A1-4A1B1 132657		
140	75	100	170	90	125	✓	-	FR9		SVX100A1-4A1N1 125701		
						✓	✓			SVX100A1-4A1B1 132658		
170	90	125	205	110	150	✓	-	FR9		SVX125A1-4A1N1 125702		
						✓	✓			SVX125A1-4A1B1 135242		
205	110	150	261	132	200	✓	-	FR9		SVX150A1-4A1N1 125704		
						✓	✓			SVX150A1-4A1B1 138432		
245	132	200	300	160	250	✓	-	FR9		SVX200A1-4A1N1 125752		
						✓	✓			SVX200A1-4A1B1 132900		

## Notes

<sup>1)</sup> Overload cycle for 60 s every 600 s

<sup>2)</sup> for normal internally and externally ventilated 4 pole, three-phase asynchronous motors with 1500 rpm<sup>-1</sup> at 50 Hz or 1800 min<sup>-1</sup> at 60 Hz

<sup>3)</sup> at 400 V, 50 Hz/at 440 - 480 V, 60 Hz



Information relevant for export to North America → Page 77





Rated operational current <sup>1)</sup>	Assigned motor rating <sup>1), 2), 3)</sup>		Rated operational current <sup>1)</sup>	Assigned motor rating <sup>1), 2), 3)</sup>		Fitted with	Frame size	Degree of Protection	Part no. Article no.	Price see price list	Std. pack
$I_H = 150\%$ $I_e$ A	$I_H = 150\%$ P kW	$I_H = 150\%$ P HP	$I_L = 110\%$ $I_e$ A	$I_L = 110\%$ P kW	$I_L = 110\%$ P HP	Radio interference suppression filter Brake chopper					
<b><math>U_e</math> 690 V AC, 3-phase / <math>U_2</math> 690 V AC, 3-phase</b> Mains voltage (50/60Hz) $U_{LN}$ : 525 (-15%) - 690 ( $\pm 10\%$ ) V											
3.2	2.2	2	4.5	3	3	✓ - ✓ ✓	FR6	IP21	SVX002A1-5A4N1 125756		1 off 
						✓ - ✓ ✓			SVX002A1-5A4B1 138480		
4.5	3	3	5.5	4	5	✓ - ✓ ✓			SVX003A1-5A4N1 125757		
						✓ - ✓ ✓			SVX003A1-5A4B1 138481		
5.5	4	5	7.5	5.5	5	✓ - ✓ ✓			SVX004A1-5A4N1 125758		
						✓ - ✓ ✓			SVX004A1-5A4B1 138482		
7.5	5.5	5	10	7.5	7.5	✓ - ✓ ✓			SVX005A1-5A4N1 125759		
						✓ - ✓ ✓			SVX005A1-5A4B1 138483		
10	7.5	7.5	13.5	11	10	✓ - ✓ ✓			SVX007A1-5A4N1 125760		
						✓ - ✓ ✓			SVX007A1-5A4B1 138484		
13.5	11	10	18	15	15	✓ - ✓ ✓	SVX010A1-5A4N1 125761				
						✓ - ✓ ✓	SVX010A1-5A4B1 138485				
18	15	15	22	18.5	20	✓ - ✓ ✓	SVX015A1-5A4N1 125762				
						✓ - ✓ ✓	SVX015A1-5A4B1 138486				
22	18.5	20	27	22	25	✓ - ✓ ✓	SVX020A1-5A4N1 125763				
						✓ - ✓ ✓	SVX020A1-5A4B1 138487				
27	22	25	34	30	30	✓ - ✓ ✓	SVX025A1-5A4N1 125764				
						✓ - ✓ ✓	SVX025A1-5A4B1 138488				
34	30	30	41	37	40	✓ - ✓ ✓	SVX030A1-5A4N1 125765				
						✓ - ✓ ✓	SVX030A1-5A4B1 138489				
41	37	40	52	45	50	✓ - ✓ ✓	SVX040A1-5A4N1 125766				
						✓ - ✓ ✓	SVX040A1-5A4B1 138490				
52	45	50	62	55	60	✓ - ✓ ✓	SVX050A1-5A4N1 125767				
						✓ - ✓ ✓	SVX050A1-5A4B1 138491				
62	55	60	80	75	75	✓ - ✓ ✓	SVX060A1-5A4N1 125768				
						✓ - ✓ ✓	SVX060A1-5A4B1 138492				
80	75	75	100	90	100	✓ - ✓ ✓	SVX075A1-5A4N1 125769				
						✓ - ✓ ✓	SVX075A1-5A4B1 138493				

**Notes**

- <sup>1)</sup> Overload cycle for 60 s every 600 s
- <sup>2)</sup> for normal internally and externally ventilated 4 pole, three-phase asynchronous motors with 1500 rpm<sup>-1</sup> at 50 Hz or 1800 min<sup>-1</sup> at 60 Hz
- <sup>3)</sup> at 690 V, 50 Hz/at 690 V, 60 Hz

 Information relevant for export to North America → Page 77

SVX/SPX

Rated operational current <sup>1)</sup>	Assigned motor rating <sup>1), 2), 3)</sup>		Rated operational current <sup>1)</sup>	Assigned motor rating <sup>1), 2), 3)</sup>		Fitted with	Frame size	Degree of Protection	Part no. Article no.	Price see price list	Std. pack
$I_H = 150\%$ $I_e$ A	$I_H = 150\%$ P kW	$I_H = 150\%$ P HP	$I_L = 110\%$ $I_e$ A	$I_L = 110\%$ P kW	$I_L = 110\%$ P HP	Radio interference suppression filter Brake chopper					
<b>U<sub>e</sub> 690 V AC, 3-phase / U<sub>2</sub> 690 V AC, 3-phase</b>											
Mains voltage (50/60Hz) U <sub>LN</sub> : 525 (-15%) - 690 (±10%) V											
100	90	100	125	110	125	✓ - ✓ ✓	FR9	IP21	<b>SVX100A1-5A4N1</b> 125770		1 off  
									<b>SVX100A1-5A4B1</b> 138494		
125	110	125	144	132	150	✓ - ✓ ✓			<b>SVX125A1-5A4N1</b> 125771		
									<b>SVX125A1-5A4B1</b> 138495		
144	132	150	170	160	200	✓ - ✓ ✓			<b>SVX150A1-5A4N1</b> 125772		
									<b>SVX150A1-5A4B1</b> 138496		
170	160	200	208	200	200	✓ - ✓ ✓			<b>SVX175A1-5A4N1</b> 125773		
									<b>SVX175A1-5A4B1</b> 138497		

**Notes**<sup>1)</sup> Overload cycle for 60 s every 600 s<sup>2)</sup> for normal internally and externally ventilated 4 pole, three-phase asynchronous motors with 1500 rpm<sup>-1</sup> at 50 Hz or 1800 min<sup>-1</sup> at 60 Hz<sup>3)</sup> at 690 V, 50 Hz/at 690 V, 60 Hz**Information relevant for export to North America → Page 77**

Rated operational current <sup>1)</sup>	Assigned motor rating <sup>1), 2), 3)</sup>		Rated operational current <sup>1)</sup>	Assigned motor rating <sup>1), 2), 3)</sup>		Fitted with		Frame size	Degree of Protection	Part no. Article no.	Price see price list	Std. pack
	$I_H = 150\%$ $I_e$ A	$I_H = 150\%$ P kW		$I_H = 150\%$ P HP	$I_L = 110\%$ $I_e$ A	$I_L = 110\%$ P kW	$I_L = 110\%$ P HP					
<b><math>U_e</math> 400 V AC, 3-phase / <math>U_2</math> 400 V AC, 3-phase</b> Mains voltage (50/60Hz) $U_{LN}$ : 380 (-15%) - 500 (+10%) V												
2.2	0.75	1	3.3	1.1	1.5	✓	✓	FR4	IP54	SVX001A2-4A1B1 125677	1 off 	
3.3	1.1	1.5	4.3	1.5	2	✓	✓			SVXF15A2-4A1B1 125708		
4.3	1.5	2	5.6	2.2	3	✓	✓			SVX002A2-4A1B1 125678		
5.6	2.2	3	7.6	3	5	✓	✓			SVX003A2-4A1B1 125680		
7.6	3	5	9	4	6	✓	✓			SVX005A2-4A1B1 125753		
9	4	6	12	5.5	7.5	✓	✓			SVX006A2-4A1B1 125683		
12	5.5	7.5	16	7.5	10	✓	✓	FR5	SVX007A2-4A1B1 125685			
16	7.5	10	23	11	15	✓	✓		SVX010A2-4A1B1 125687			
23	11	15	31	15	20	✓	✓		SVX015A2-4A1B1 125689			
31	15	20	38	18.5	25	✓	✓	FR6	SVX020A2-4A1B1 125754			
38	18.5	25	46	22	30	✓	✓		SVX025A2-4A1B1 125692			
46	22	30	61	30	40	✓	✓		SVX030A2-4A1B1 125694			
61	30	40	72	37	50	✓	-	FR7	SVX040A2-4A1N1 125696			
						✓	✓		SVX040A2-4A1B1 138452			
72	37	50	87	45	60	✓	-		SVX050A2-4A1N1 125697			
						✓	✓		SVX050A2-4A1B1 138453			
87	45	60	105	55	75	✓	-		SVX060A2-4A1N1 125698			
						✓	✓		SVX060A2-4A1B1 138454			
105	55	75	140	75	100	✓	-	FR8	SVX075A2-4A1N1 125700			
						✓	✓		SVX075A2-4A1B1 138455			
140	75	100	170	90	125	✓	-		SVX100A2-4A1N1 125755			
						✓	✓	SVX100A2-4A1B1 138456				
170	90	125	205	110	150	✓	-	FR9	SVX125A2-4A1N1 125703			
						✓	✓		SVX125A2-4A1B1 138457			
205	110	150	261	132	200	✓	-		SVX150A2-4A1N1 125705			
						✓	✓	SVX150A2-4A1B1 138458				
245	132	200	300 300	160	250	✓	-		SVX200A2-4A1N1 125706			
						✓	✓		SVX200A2-4A1B1 138459			

**Notes**

<sup>1)</sup> Overload cycle for 60 s every 600 s

<sup>2)</sup> for normal internally and externally ventilated 4 pole, three-phase asynchronous motors with 1500 rpm<sup>-1</sup> at 50 Hz or 1800 min<sup>-1</sup> at 60 Hz

<sup>3)</sup> at 400 V, 50 Hz/at 440 - 480 V, 60 Hz

Information relevant for export to North America → Page 77

SVX/SPX

Rated operational current <sup>1)</sup>	Assigned motor rating <sup>1), 2), 3)</sup>		Rated operational current <sup>1)</sup>	Assigned motor rating <sup>1), 2), 3)</sup>		Fitted with	Frame size	Degree of Protection	Part no. Article no.	Price see price list	Std. pack	
$I_H = 150\%$ $I_e$ A	$I_H = 150\%$ P kW	$I_H = 150\%$ P HP	$I_L = 110\%$ $I_e$ A	$I_L = 110\%$ P kW	$I_L = 110\%$ P HP	Radio interference suppression filter Brake chopper						
$U_e$ 690 V AC, 3-phase / $U_2$ 690 V AC, 3-phase Mains voltage (50/60Hz) $U_{LN}$ : 525 (-15%) - 690 ( $\pm 10\%$ ) V												
3.2	2.2	2	4.5	3	3	✓ - ✓ ✓	FR6	IP54	SVX002A2-5A4N1 125774		1 off 	
						✓ - ✓ ✓			SVX002A2-5A4B1 138498			
4.5	3	3	5.5	4	5	✓ - ✓ ✓			SVX003A2-5A4N1 125775			SVX003A2-5A4B1 138499
5.5	4	5	7.5	5.5		✓ - ✓ ✓			SVX004A2-5A4N1 125776			SVX004A2-5A4B1 138500
7.5	5.5		10	7.5	7.5	✓ - ✓ ✓			SVX005A2-5A4N1 125777			SVX005A2-5A4B1 138501
10	7.5	7.5	13.5	11	10	✓ - ✓ ✓			SVX007A2-5A4N1 125778			SVX007A2-5A4B1 138502
13.5	11	10	18	15	15	✓ - ✓ ✓			SVX010A2-5A4N1 125779			SVX010A2-5A4B1 138503
18	15	15	22	18.5	20	✓ - ✓ ✓			SVX015A2-5A4N1 125780			SVX015A2-5A4B1 138504
22	18.5	20	27	22	25	✓ - ✓ ✓			SVX020A2-5A4N1 125781			SVX020A2-5A4B1 138505
27	22	25	34	30	30	✓ - ✓ ✓			SVX025A2-5A4N1 125782			SVX025A2-5A4B1 138506
34	30	30	41	37	40	✓ - ✓ ✓	FR7	SVX030A2-5A4N1 125783	SVX030A2-5A4B1 138507			
41	37	40	52	45	50	✓ - ✓ ✓		SVX040A2-5A4N1 125784	SVX040A2-5A4B1 138508			
52	45	50	62	55	60	✓ - ✓ ✓	FR8	SVX050A2-5A4N1 125785	SVX050A2-5A4B1 138509			
62	55	60	80	75	75	✓ - ✓ ✓		SVX060A2-5A4N1 125786	SVX060A2-5A4B1 138510			
80	75	75	100	90	100	✓ - ✓ ✓		SVX075A2-5A4N1 125787	SVX075A2-5A4B1 138511			

**Notes**

<sup>1)</sup> Overload cycle for 60 s every 600 s

<sup>2)</sup> for normal internally and externally ventilated 4 pole, three-phase asynchronous motors with 1500 rpm<sup>-1</sup> at 50 Hz or 1800 min<sup>-1</sup> at 60 Hz

<sup>3)</sup> at 690 V, 50 Hz/at 690 V, 60 Hz

 Information relevant for export to North America → Page 77

Rated operational current <sup>1)</sup>	Assigned motor rating <sup>1), 2), 3)</sup>		Rated operational current <sup>1)</sup>	Assigned motor rating <sup>1), 2), 3)</sup>		Fitted with	Frame size	Degree of Protection	Part no. Article no.	Price see price list	Std. pack
$I_H = 150\%$ $I_e$ A	$I_H = 150\%$ P kW	$I_H = 150\%$ P HP	$I_L = 110\%$ $I_e$ A	$I_L = 110\%$ P kW	$I_L = 110\%$ P HP	Radio interference suppression filter Brake chopper					
<b><math>U_e</math> 690 V AC, 3-phase / <math>U_2</math> 690 V AC, 3-phase</b> Mains voltage (50/60Hz) $U_{LN}$ : 525 (-15%) - 690 ( $\pm 10\%$ ) V											
100	90	100	125	110	125	✓ - ✓ ✓	FR9	IP54	<b>SVX100A2-5A4N1</b> 125788		1 off 
									<b>SVX100A2-5A4B1</b> 138512		
125	110	125	144	132	150	✓ - ✓ ✓			<b>SVX125A2-5A4N1</b> 125789		
									<b>SVX125A2-5A4B1</b> 138513		
144	132	150	170	160	200	✓ - ✓ ✓			<b>SVX150A2-5A4N1</b> 125790		
									<b>SVX150A2-5A4B1</b> 138514		
170	160	200	208	200	200	✓ - ✓ ✓			<b>SVX175A2-5A4N1</b> 125791		
									<b>SVX175A2-5A4B1</b> 138515		



**Notes**

<sup>1)</sup> Overload cycle for 60 s every 600 s

<sup>2)</sup> for normal internally and externally ventilated 4 pole, three-phase asynchronous motors with 1500 rpm<sup>-1</sup> at 50 Hz or 1800 min<sup>-1</sup> at 60 Hz

<sup>3)</sup> at 690 V, 50 Hz/at 690 V, 60 Hz

**Information relevant for export to North America** → Page 77

Rated operational current <sup>1)</sup>	Assigned motor rating <sup>1), 2), 3)</sup>		Rated operational current <sup>1)</sup>	Assigned motor rating <sup>1), 2), 3)</sup>		Fitted with		Frame size	Degree of Protection	Part no. Article no.	Price see price list	Std. pack
	I <sub>H</sub> = 150 % I <sub>e</sub> A	I <sub>H</sub> = 150 % P kW		I <sub>H</sub> = 150 % P HP	I <sub>L</sub> = 110 % I <sub>e</sub> A	I <sub>L</sub> = 110 % P kW	I <sub>L</sub> = 110 % P HP					
U <sub>e</sub> 400 V AC, 3-phase / U <sub>2</sub> 400 V AC, 3-phase Mains voltage (50/60Hz) U <sub>L,N</sub> : 380 (-15%) - 500 (+10%) V												
2.2	0.75	1	3.3	1.1	1.5	✓	✓	FR4	IP21	SPX001A1-4A1B1 125203	1 off  	
3.3	1.1	1.5	4.3	1.5	2	✓	✓			SPXF15A1-4A1B1 125675		
4.3	1.5	2	5.6	2.2	3	✓	✓			SPX002A1-4A1B1 125657		
5.6	2.2	3	7.6	3	5	✓	✓			SPX003A1-4A1B1 125658		
7.6	3	5	9	4	6	✓	✓			SPX005A1-4A1B1 125659		
9	4	6	12	5.5	7.5	✓	✓			SPX006A1-4A1B1 125249		
12	5.5	7.5	16	7.5	10	✓	✓	FR5	SPX007A1-4A1B1 125660			
16	7.5	10	23	11	15	✓	✓		SPX010A1-4A1B1 125661			
23	11	15	31	15	20	✓	✓		SPX015A1-4A1B1 125663			
31	15	20	38	18.5	25	✓	✓	FR6	SPX020A1-4A1B1 125665			
38	18.5	25	46	22	30	✓	✓		SPX025A1-4A1B1 125666			
46	22	30	61	30	40	✓	✓		SPX030A1-4A1B1 125667			
61	30	40	72	37	50	✓	-	FR7	SPX040A1-4A1N1 125319			
						✓	✓		SPX040A1-4A1B1 134844			
72	37	50	87	45	60	✓	-		SPX050A1-4A1N1 125331			
						✓	✓	SPX050A1-4A1B1 138606				
87	45	60	105	55	75	✓	-	FR8	SPX060A1-4A1N1 125668			
						✓	✓		SPX060A1-4A1B1 138607			
105	55	75	140	75	100	✓	-		SPX075A1-4A1N1 125354			
						✓	✓	SPX075A1-4A1B1 138608				
140	75	100	170	90	125	✓	-	FR9	SPX100A1-4A1N1 125365			
						✓	✓		SPX100A1-4A1B1 131744			
170	90	125	205	110	150	✓	-		SPX125A1-4A1N1 125669			
						✓	✓	SPX125A1-4A1B1 134489				
205	110	150	261	132	200	✓	-	FR9	SPX150A1-4A1N1 125381			
						✓	✓		SPX150A1-4A1B1 129701			
245	132	200	300	160	250	✓	-		SPX200A1-4A1N1 125670			
						✓	✓	SPX200A1-4A1B1 134845				

## Notes



<sup>1)</sup> Overload cycle for 60 s every 600 s

<sup>2)</sup> for normal internally and externally ventilated 4 pole, three-phase asynchronous motors with 1500 rpm<sup>-1</sup> at 50 Hz or 1800 min<sup>-1</sup> at 60 Hz

<sup>3)</sup> at 400 V, 50 Hz/at 440 - 480 V, 60 Hz



Information relevant for export to North America → Page 77



Rated operational current <sup>1)</sup>	Assigned motor rating <sup>1), 2), 3)</sup>		Rated operational current <sup>1)</sup>	Assigned motor rating <sup>1), 2), 3)</sup>		Fitted with		Frame size	Degree of Protection	Part no. Article no.	Price see price list	Std. pack
$I_H = 150\%$ $I_e$ A	$I_H = 150\%$ P kW	$I_H = 150\%$ P HP	$I_L = 110\%$ $I_e$ A	$I_L = 110\%$ P kW	$I_L = 110\%$ P HP	Radio interference suppression filter	Brake chopper					
<b><math>U_e</math> 400 V AC, 3-phase / <math>U_2</math> 400 V AC, 3-phase</b> Mains voltage (50/60Hz) $U_{LN}$ : 380 (-15%) - 500 (+10%) V												
300	160	250	385	200	300	✓	✓	FR10	IP21	SPX250A1-4A4B1 133131		1 off  
						✓	-			SPX250A1-4A4N1 125671		
385	200	300	460	250	350	✓	-			SPX300A1-4A4N1 125673		
460	250	350	520			✓	-			SPX350A1-4A4N1 125424		
520	250	400	590	315	500	✓	-	FR11		SPX400A1-4A4N1 125432		
590	315	500	650	355	550	✓	-			SPX500A1-4A4N1 125444		
650	355	550	730	400	600	✓	-			SPX550A1-4A4N1 125451		
300	160	250	385	200	300	-	✓	FR10	IP00	SPX250A0-4A2B1 133130		
						-	-			SPX250A0-4A2N1 125402		
385	200	300	460	250	350	-	✓			SPX300A0-4A2B1 138617		
						-	-			SPX300A0-4A2N1 125412		
460	250	350	520			-	✓			SPX350A0-4A2B1 129686		
						-	-			SPX350A0-4A2N1 125711		
520		400	590	315	500	-	✓	FR11		SPX400A0-4A2B1 138618		
						-	-			SPX400A0-4A2N1 125428		
590	315	500	650	355	550	-	✓			SPX500A0-4A2B1 138619		
						-	-			SPX500A0-4A2N1 125440		
650	355	550	730	400	600	-	✓			SPX550A0-4A2B1 138620		
						-	-			SPX550A0-4A2N1 125674		
730	400	600	820	450	650	-	✓	FR12		SPX600A0-4A2B1 129687		
						-	-			SPX600A0-4A2N1 125453		
820	450	650	920	500	700	-	-			SPX650A0-4A2N1 125457		
920	500	700	1030	560	800	-	-			SPX700A0-4A2N1 125459		
1030	560	800	1150	630	900	-	-	FR13		SPX800A0-4A2N1 125463		
1150	630	900	1300	710	1000	-	-			SPX900A0-4A2N1 125467		
1300	710	1000	1450	800	1200	-	-			SPXH10A0-4A2N1 125482		
1600	900	1200	1770	1000	1600	-	-	FR14		SPXH12A0-4A2N1 125486		
1940	1100	1600	2150	1200	2000	-	-			SPXH16A0-4A2N1 125492		

**Notes**

<sup>1)</sup> Overload cycle for 60 s every 600 s

<sup>2)</sup> for normal internally and externally ventilated 4 pole, three-phase asynchronous motors with 1500 rpm<sup>-1</sup> at 50 Hz or 1800 min<sup>-1</sup> at 60 Hz

<sup>3)</sup> at 400 V, 50 Hz/at 440 - 480 V, 60 Hz

  **Information relevant for export to North America** → Page 77

Rated operational current <sup>1)</sup>	Assigned motor rating <sup>1), 2), 3)</sup>		Rated operational current <sup>1)</sup>	Assigned motor rating <sup>1), 2), 3)</sup>		Fitted with		Frame size	Degree of Protection	Part no. Article no.	Price see price list	Std. pack
	$I_H = 150\%$ $I_e$ A	$I_H = 150\%$ P kW		$I_H = 150\%$ P HP	$I_L = 110\%$ $I_e$ A	$I_L = 110\%$ P kW	$I_L = 110\%$ P HP					
<b><math>U_e</math> 690 V AC, 3-phase / <math>U_2</math> 690 V AC, 3-phase</b> Mains voltage (50/60Hz) $U_{LN}$ : 525 (-15%) - 690 ( $\pm 10\%$ ) V												
3.2	2.2	2	4.5	3	3	✓	-	FR6	IP21	SPX002A1-5A4N1 125212	1 off 	
						✓	✓			SPX002A1-5A4B1 138638		
4.5	3	3	5.5	4	5	✓	-			SPX003A1-5A4N1 125222		
						✓	✓			SPX003A1-5A4B1 138639		
5.5	4	5	7.5	5.5		✓	-			SPX004A1-5A4N1 125232		
						✓	✓			SPX004A1-5A4B1 138640		
7.5	5.5		10	7.5	7.5	✓	-			SPX005A1-5A4N1 125241		
						✓	✓			SPX005A1-5A4B1 138641		
10	7.5	7.5	13.5	11	10	✓	-			SPX007A1-5A4N1 125256		
						✓	✓			SPX007A1-5A4B1 138642		
13.5	11	10	18	15	15	✓	-			SPX010A1-5A4N1 125267		
						✓	✓			SPX010A1-5A4B1 138643		
18	15	15	22	18.5	20	✓	-	SPX015A1-5A4N1 125277				
						✓	✓	SPX015A1-5A4B1 138644				
22	18.5	20	27	22	25	✓	-	SPX020A1-5A4N1 125287				
						✓	✓	SPX020A1-5A4B1 138645				
27	22	25	34	30	30	✓	-	SPX025A1-5A4N1 125298				
						✓	✓	SPX025A1-5A4B1 138646				
34	30	30	41	37	40	✓	-	FR7	SPX030A1-5A4N1 125309			
						✓	✓		SPX030A1-5A4B1 138647			
41	37	40	52	45	50	✓	-	SPX040A1-5A4N1 125321				
						✓	✓	SPX040A1-5A4B1 138648				
52	45	50	62	55	60	✓	-	FR8	SPX050A1-5A4N1 125333			
						✓	✓		SPX050A1-5A4B1 138649			
62	55	60	80	75	75	✓	-	SPX060A1-5A4N1 125344				
						✓	✓	SPX060A1-5A4B1 138650				
80	75	75	100	90	100	✓	-	SPX075A1-5A4N1 125356				
						✓	✓	SPX075A1-5A4B1 138651				

Notes





<sup>1)</sup> Overload cycle for 60 s every 600 s

<sup>2)</sup> for normal internally and externally ventilated 4 pole, three-phase asynchronous motors with 1500 rpm<sup>-1</sup> at 50 Hz or 1800 min<sup>-1</sup> at 60 Hz

<sup>3)</sup> at 690 V, 50 Hz/at 690 V, 60 Hz



 Information relevant for export to North America → Page 77





Rated operational current <sup>1)</sup>	Assigned motor rating <sup>1), 2), 3)</sup>		Rated operational current <sup>1)</sup>	Assigned motor rating <sup>1), 2), 3)</sup>		Fitted with	Frame size	Degree of Protection	Part no. Article no.	Price see price list	Std. pack	
I <sub>H</sub> = 150 % I <sub>e</sub> A	I <sub>H</sub> = 150 % P kW	I <sub>H</sub> = 150 % P HP	I <sub>L</sub> = 110 % I <sub>e</sub> A	I <sub>L</sub> = 110 % P kW	I <sub>L</sub> = 110 % P HP	Radio interference suppression filter Brake chopper						
<b>U<sub>e</sub> 690 V AC, 3-phase / U<sub>2</sub> 690 V AC, 3-phase</b> Mains voltage (50/60Hz) U <sub>LN</sub> : 525 (-15%) - 690 (±10%) V												
100	90	100	125	110	125	✓ - ✓ ✓	FR9	IP21	<b>SPX100A1-5A4N1</b> 125367		1 off  	
									<b>SPX100A1-5A4B1</b> 138652			
125	110	125	144	132	150	✓ - ✓ ✓			<b>SPX125A1-5A4N1</b> 125375			
									<b>SPX125A1-5A4B1</b> 138653			
144	132	150	170	160	200	✓ - ✓ ✓			<b>SPX150A1-5A4N1</b> 125383			
									<b>SPX150A1-5A4B1</b> 138654			
170	160	200	208	200		✓ - ✓ ✓			<b>SPX175A1-5A4N1</b> 125389			
									<b>SPX175A1-5A4B1</b> 138655			
208	200		261	250	300	✓ -	FR10		<b>SPX200A1-5A4N1</b> 125396			
261	250	250	325	315		✓ -			<b>SPX250A1-5A4N1</b> 125407			
325	315	300	385	355	400	✓ -			<b>SPX300A1-5A4N1</b> 125417			
385	355	400	460	450	450	✓ -	FR11		<b>SPX400A1-5A4N1</b> 125434			
460	450	450	502	500	500	✓ -			<b>SPX450A1-5A4N1</b> 125438			
502	500	500	590	560	600	✓ -			<b>SPX500A1-5A4N1</b> 125446			
208	200	200	261	250	300	- -	FR10	IP00	<b>SPX200A0-5A2N1</b> 129600			1 off  
261	250	250	325	315		- -			<b>SPX250A0-5A2N1</b> 129602			
325	315	300	385	355	400	- -			<b>SPX300A0-5A2N1</b> 129604			
385	355	400	460	450	450	- -	FR11		<b>SPX400A0-5A2N1</b> 129607			
460	450	450	502	500	500	- -			<b>SPX450A0-5A2N1</b> 129608			
502	500	500	590	560	600	- -			<b>SPX500A0-5A2N1</b> 129610			
590	560	600	650	630	750	- -	FR12		<b>SPX550A0-5A2N1</b> 129612			
650	630		750	710	850	- -			<b>SPX600A0-5A2N1</b> 129614			
750	710	850	820	800		- -			<b>SPX700A0-5A2N1</b> 129617			
820	800		920	900	1100	- -	FR13		<b>SPX800A0-5A2N1</b> 129618			
920	900	1100	1030	1000		- -			<b>SPX900A0-5A2N1</b> 129619			
1030	1000		1180	1150	1300	- -			<b>SPXH10A0-5A2N1</b> 129620			
1300	1300	1300	1500	1500		- -	FR14		<b>SPXH13A0-5A2N1</b> 129621			
1500	1500		1900	1800		- -			<b>SPXH15A0-5A2N1</b> 129622			
1900	1800		2250	2000		- -			<b>SPXH20A0-5A2N1</b> 129623			

**Notes**

- <sup>1)</sup> Overload cycle for 60 s every 600 s
- <sup>2)</sup> for normal internally and externally ventilated 4 pole, three-phase asynchronous motors with 1500 rpm<sup>-1</sup> at 50 Hz or 1800 min<sup>-1</sup> at 60 Hz
- <sup>3)</sup> at 690 V, 50 Hz/at 690 V, 60 Hz

  Information relevant for export to North America → Page 77

SVX/SPX



Rated operational current <sup>1)</sup>	Assigned motor rating <sup>1), 2), 3)</sup>		Rated operational current <sup>1)</sup>	Assigned motor rating <sup>1), 2), 3)</sup>		Fitted with		Frame size	Degree of Protection	Part no. Article no.	Price see price list	Std. pack
	I <sub>H</sub> = 150 % I <sub>e</sub> A	I <sub>H</sub> = 150 % P kW		I <sub>H</sub> = 150 % P HP	I <sub>L</sub> = 110 % I <sub>e</sub> A	I <sub>L</sub> = 110 % P kW	I <sub>L</sub> = 110 % P HP					
U <sub>e</sub> 400 V AC, 3-phase / U <sub>2</sub> 400 V AC, 3-phase Mains voltage (50/60Hz) U <sub>LN</sub> : 380 (-15%) - 500 (+10%) V												
2.2	0.75	1	3.3	1.1	1.5	✓	✓	FR4	IP54	SPX001A2-4A1B1 125207	1 off  	
3.3	1.1	1.5	4.3	1.5	2	✓	✓			SPXF15A2-4A1B1 125480		
4.3	1.5	2	5.6	2.2	3	✓	✓			SPX002A2-4A1B1 125216		
5.6	2.2	3	7.6	3	5	✓	✓			SPX003A2-4A1B1 125226		
7.6	3	5	9	4	6	✓	✓			SPX005A2-4A1B1 125245		
9	4	6	12	5.5	7.5	✓	✓			SPX006A2-4A1B1 125251		
12	5.5	7.5	16	7.5	10	✓	✓	FR5	SPX007A2-4A1B1 125260			
16	7.5	10	23	11	15	✓	✓		SPX010A2-4A1B1 125662			
23	11	15	31	15	20	✓	✓		SPX015A2-4A1B1 125664			
31	15	20	38	18.5	25	✓	✓	FR6	SPX020A2-4A1B1 125291			
38	18.5	25	46	22	30	✓	✓		SPX025A2-4A1B1 125302			
46	22	30	61	30	40	✓	✓		SPX030A2-4A1B1 125313			
61	30	40	72	37	50	✓	-	FR7	SPX040A2-4A1N1 125325			
						✓	✓		SPX040A2-4A1B1 138609			
72	37	50	87	45	60	✓	-		SPX050A2-4A1N1 125337			
						✓	✓		SPX050A2-4A1B1 138610			
87	45	60	105	55	75	✓	-	FR8	SPX060A2-4A1N1 125348			
						✓	✓		SPX060A2-4A1B1 138611			
105	55	75	140	75	100	✓	-	FR8	SPX075A2-4A1N1 125359			
						✓	✓		SPX075A2-4A1B1 138612			
140	75	100	170	90	125	✓	-		SPX100A2-4A1N1 125370			
						✓	✓	SPX100A2-4A1B1 138613				
170	90	125	205	110	150	✓	-	FR9	SPX125A2-4A1N1 125377			
						✓	✓		SPX125A2-4A1B1 138614			
205	110	150	261 261	132	200	✓	-	FR9	SPX150A2-4A1N1 125385			
						✓	✓		SPX150A2-4A1B1 138615			
245	132	200	300	160	250	✓	-	FR10	SPX200A2-4A1N1 125398			
						✓	✓		SPX200A2-4A1B1 138616			
300	160	250	385	200	300	✓	-	FR10	SPX250A2-4A4N1 125672			
385	200	300	460	250	350	✓	-		SPX300A2-4A4N1 125419			
460	250	350	520			✓	-		SPX350A2-4A4N1 125426			

Notes

<sup>1)</sup> Overload cycle for 60 s every 600 s

<sup>2)</sup> for normal internally and externally ventilated 4 pole, three-phase asynchronous motors with 1500 rpm<sup>-1</sup> at 50 Hz or 1800 min<sup>-1</sup> at 60 Hz

<sup>3)</sup> at 400 V, 50 Hz/at 440 - 480 V, 60 Hz

  Information relevant for export to North America → Page 77

Rated operational current <sup>1)</sup>	Assigned motor rating <sup>1), 2), 3)</sup>		Rated operational current <sup>1)</sup>	Assigned motor rating <sup>1), 2), 3)</sup>		Fitted with		Frame size	Degree of Protection	Part no. Article no.	Price see price list	Std. pack
	$I_H = 150\%$ $I_e$ A	$I_H = 150\%$ P kW		$I_H = 150\%$ P HP	$I_L = 110\%$ $I_e$ A	$I_L = 110\%$ P kW	$I_L = 110\%$ P HP					
<b><math>U_e</math> 690 V AC, 3-phase / <math>U_2</math> 690 V AC, 3-phase</b> Mains voltage (50/60Hz) $U_{LN}$ : 525 (-15%) - 690 ( $\pm 10\%$ ) V												
3.2	2.2	2	4.5	3	3	✓	-	FR6	IP54	SPX002A2-5A4N1 125218		1 off 
						✓	✓			SPX002A2-5A4B1 129582		
4.5	3	3	5.5	4	5	✓	-			SPX003A2-5A4N1 125228		
						✓	✓			SPX003A2-5A4B1 129583		
5.5	4	5	7.5	5.5		✓	✓			SPX004A2-5A4B1 129584		
						✓	-			SPX004A2-5A4N1 125236		
7.5	5.5		10	7.5	7.5	✓	-			SPX005A2-5A4N1 125247		
						✓	✓			SPX005A2-5A4B1 129585		
10	7.5	7.5	13.5	11	10	✓	-			SPX007A2-5A4N1 125262		
						✓	✓			SPX007A2-5A4B1 129586		
13.5	11	10	18	15	15	✓	-	SPX010A2-5A4N1 125272				
						✓	✓	SPX010A2-5A4B1 129587				
18	15	15	22	18.5	20	✓	-	SPX015A2-5A4N1 125282				
						✓	✓	SPX015A2-5A4B1 129588				
22	18.5	20	27	22	25	✓	-	SPX020A2-5A4N1 125293				
						✓	✓	SPX020A2-5A4B1 129589				
27	22	25	34	30	30	✓	-	SPX025A2-5A4N1 125304				
						✓	✓	SPX025A2-5A4B1 129590				
34	30	30	41	37	40	✓	-	SPX030A2-5A4N1 125315				
						✓	✓	SPX030A2-5A4B1 129591				
41	37	40	52	45	50	✓	-	SPX040A2-5A4N1 125327				
						✓	✓	SPX040A2-5A4B1 129592				
52	45	50	62	55	60	✓	-	SPX050A2-5A4N1 125339				
						✓	✓	SPX050A2-5A4B1 129593				
62	55	60	80	75	75	✓	-	SPX060A2-5A4N1 125350				
						✓	✓	SPX060A2-5A4B1 129594				
80	75	75	100	90	100	✓	-	SPX075A2-5A4N1 125361				
						✓	✓	SPX075A2-5A4B1 129595				

**Notes**

- <sup>1)</sup> Overload cycle for 60 s every 600 s
- <sup>2)</sup> for normal internally and externally ventilated 4 pole, three-phase asynchronous motors with 1500 rpm<sup>-1</sup> at 50 Hz or 1800 min<sup>-1</sup> at 60 Hz
- <sup>3)</sup> at 690 V, 50 Hz/at 690 V, 60 Hz













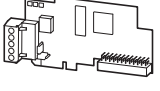

 Information relevant for export to North America → Page 77

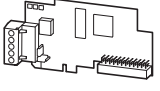

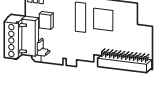
SVX/SPX

Rated operational current <sup>1)</sup>	Assigned motor rating <sup>1), 2), 3)</sup>		Rated operational current <sup>1)</sup>	Assigned motor rating <sup>1), 2), 3)</sup>		Fitted with	Frame size	Degree of Protection	Part no. Article no.	Price see price list	Std. pack
$I_H = 150\%$ $I_e$ A	$I_H = 150\%$ P kW	$I_H = 150\%$ P HP	$I_L = 110\%$ $I_e$ A	$I_L = 110\%$ P kW	$I_L = 110\%$ P HP	Radio interference suppression filter Brake chopper					
<b>U<sub>e</sub> 690 V AC, 3-phase / U<sub>2</sub> 690 V AC, 3-phase</b> Mains voltage (50/60Hz) U <sub>LN</sub> : 525 (-15%) - 690 (±10%) V											
100	90	100	125	110	125	✓ - ✓ ✓	FR9	IP54	<b>SPX100A2-5A4N1</b> 125372		1 off 
									<b>SPX100A2-5A4B1</b> 129596		
125	110	125	144	132	150	✓ - ✓ ✓			<b>SPX125A2-5A4N1</b> 125379		
									<b>SPX125A2-5A4B1</b> 129597		
144	132	150	170	160	200	✓ - ✓ ✓			<b>SPX150A2-5A4N1</b> 125387		
									<b>SPX150A2-5A4B1</b> 129598		
170	160	200	208	200		✓ - ✓ ✓			<b>SPX175A2-5A4N1</b> 125391		
									<b>SPX175A2-5A4B1</b> 129599		
208	200		261	250	300	✓ -	FR10		<b>SPX200A2-5A4N1</b> 125400		
261	250	250	325	315		✓ -			<b>SPX250A2-5A4N1</b> 125410		
325	315	300	385	355	400	✓ -			<b>SPX300A2-5A4N1</b> 125421		

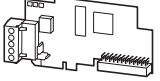
**Notes**<sup>1)</sup> Overload cycle for 60 s every 600 s<sup>2)</sup> for normal internally and externally ventilated 4 pole, three-phase asynchronous motors with 1500 rpm<sup>-1</sup> at 50 Hz or 1800 min<sup>-1</sup> at 60 Hz<sup>3)</sup> at 690 V, 50 Hz/at 690 V, 60 Hz**Information relevant for export to North America → Page 77**

## Accessories

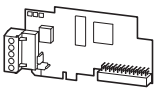
Description	For use with	Part no. Article no.	Price see price list	Std. pack	Information relevant for export to North America 
<b>External keypad</b>					
With illuminated LCD display Plain text, multi-line With control buttons and function keys Front IP54	SVX, SPX	<b>KEYPAD-LOC/REM</b> 139787		1 off 	Product Standards UL 508C; CSA-C22.2 No. 14; IEC/EN61800-3; IEC/EN61800-5; CE marking E134360  UL File No. UL Category Control No. NMMS, NMMS2, NMMS7, NMMS8  CSA File No. UL report applies to both US and Canada  North America Certification UL listed, certified by UL for use in Canada Branch circuits  Suitable for
External keypad					
Mounting frame for control panel door 2 m	KEYPAD- LOC/REM	<b>OPTRMT-KIT</b> 126868		1 off 	
Connection cable					
Connection between variable frequency drive and PC 1.5 m	SVX, SPX	<b>SVDRIVCABLE</b> 129001		1 off 	
<b>Expansion modules</b>					
The expansion module is plugged into the variable-frequency drive.					
<b>Adapters</b>					
	System bus adapter	SPX	<b>OPTD1</b> 125077	1 off 	
	System bus adapter with CANopen® interface	SPX	<b>OPTD2</b> 125078		
	RS232 adapter	SPX	<b>OPTD3</b> 125079		
<b>Output expansion</b>					
	1 relay output (NO/NC) 1 relay output (NC) 1 Thermistor input	SPX	<b>OPTA3</b> 125050	1 off 	
	2 relay outputs (NO/NC)	SVX, SPX	<b>OPTA2</b> 125049		
	1 relay output (NO) 5 digital inputs (42 - 240 V AC)	SVX, SPX	<b>OPTB9</b> 125064		
	3 relay outputs (NO)	SVX, SPX	<b>OPTB5</b> 125062		
	1 relay output (NO/NC) 1 relay output (NO) 1 Thermistor input	SVX, SPX	<b>OPTB2</b> 125060		
<b>I/O expansion</b>					
	6 digital inputs External 24 V supply	SVX, SPX	<b>OPTB1</b> 125059	1 off 	
	6 digital inputs 1 digital output 2 analog inputs (mA/V) 1 analog output	SVX, SPX	<b>OPTA9</b> 125055		
	3 digital inputs 1 relay output (NO/NC) 1 digital output	SVX, SPX	<b>OPTA4</b> 125056		
	6 digital inputs 1 digital output 2 analog inputs (mA/V) 1 analog output	SPX	<b>OPTA8</b> 125054		
	1 analog input (mA, isolated) 2 analog outputs (mA, isolated)	SVX, SPX	<b>OPTB4</b> 125061		
<b>Encoder module</b>					
	HTL (+15 V/24 V) Master / Slave capability	SPX	<b>OPTA7</b> 125053	1 off 	
<b>Temperature sensor expansion</b>					
	3 Pt100 External 24 V supply	SVX, SPX	<b>OPTB8</b> 125063	1 off 	

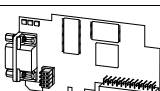
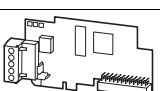
Description	For use with	Part no. Article no.	Price see price list	Std. pack	Information relevant for export to North America 
<b>Fieldbus modules</b>					
The field bus module is plugged into the variable-frequency drive.					
	Modbus RS485 Screw terminals	SVX, SPX	<b>OPTC2</b> 125067	1 off 	Product Standards UL 508C; CSA-C22.2 No. 14; IEC/EN61800-3; IEC/EN61800-5; CE marking E134360  UL File No. UL Category Control No. CSA File No.  North America Certification Suitable for
	PROFIBUS-DP Screw terminals	SVX, SPX	<b>OPTC3</b> 125068		
	LonWorks Screw terminals	SVX, SPX	<b>OPTC4</b> 125069		
	CANopen® Screw terminals	SVX, SPX	<b>OPTC6</b> 125710		
	PROFIBUS-DP SUB-D 9 pole, socket	SVX, SPX	<b>OPTC5</b> 125070		
	DeviceNet SUB-D 9 pole, socket	SVX, SPX	<b>OPTC7</b> 125071		
	Modbus RS485 SUB-D 9 pole, socket	SVX, SPX	<b>OPTC8</b> 125072		
	Modbus-TCP RJ45, 8-pole	SVX, SPX	<b>OPTCI</b> 125075		
	BACnet/IP RJ45, 8-pole	SVX, SPX	<b>OPTCJ</b> 125076		







Part no.	Motor		Frequency inverters		Power Wiring Main choke	Motor feeder motor choke		Sine filter	
	Assigned motor rating		Rated operational current			I <sub>H</sub> = 150 % (CT/I <sub>H</sub> , at 50 °C)	I <sub>L</sub> = 110 % (VT/I <sub>L</sub> , at 40 °C)	I <sub>H</sub> = 150 % (CT/I <sub>H</sub> , at 50 °C)	I <sub>L</sub> = 110 % (VT/I <sub>L</sub> , at 40 °C)
	I <sub>H</sub> = 150 % P kW	I <sub>L</sub> = 110 % P kW	I <sub>H</sub> = 150 % I <sub>e</sub> A	I <sub>L</sub> = 110 % I <sub>e</sub> A					
SPX060A1-4...	45	55	87	105	DX-LN3-120	DX-LM3-100	DX-LM3-150	DX-SIN3-090	DX-SIN3-115
SPX075A1-4...	55	75	105	140	DX-LN3-160	DX-LM3-150	DX-LM3-150	DX-SIN3-115	DX-SIN3-150
SPX100A1-4...	75	90	140	170	DX-LN3-200	DX-LM3-150	DX-LM3-180	DX-SIN3-150	DX-SIN3-180
SPX125A1-4...	90	110	170	205	DX-LN3-250	DX-LM3-180	DX-LM3-220	DX-SIN3-180	DX-SIN3-250
SPX150A1-4...	110	132	205	261	DX-LN3-300	DX-LM3-220	DX-LM3-260	DX-SIN3-250	DX-SIN3-440
SPX200A1-4...	132	160	245	300	DX-LN3-300	DX-LM3-260	DX-LM3-303	DX-SIN3-250	DX-SIN3-440
SPX250A0-4...	160	200	300	385	-	DX-LM3-303	DX-LM3-450	DX-SIN3-440	DX-SIN3-440
SPX300A0-4...	200	250	385	460	-	DX-LM3-450	DUT-0590-6-0-S	DX-SIN3-440	DX-SIN3-480
SPX350A0-4...	250	250	460	520	-	DUT-0590-6-0-S	DUT-0590-6-0-S	SIN-0600-5-0-P	SIN-0600-5-0-P
SPX400A0-4...	250	315	520	590	-	DUT-0590-6-0-S	DUT-0590-6-0-S	SIN-0600-5-0-P	SIN-0600-5-0-P
SPX500A0-4...	315	355	590	650	-	DUT-0820-6-0-S	DUT-0820-6-0-S	SIN-0600-5-0-P	SIN-0840-5-0-P
SPX550A0-4...	355	400	650	730	-	DUT-0820-6-0-S	DUT-1100-6-0-S	SIN-0840-5-0-P	SIN-0840-5-0-P
SPX600A0-4...	400	450	730	820	-	DUT-1250-6-0-S	DUT-1100-6-0-S	SIN-0840-5-0-P	SIN-0840-5-0-P
SPX650A0-4...	450	500	820	920	-	DUT-1250-6-0-S	DUT-1100-6-0-S	SIN-1160-5-0-P	SIN-1160-5-0-P
SPX700A0-4...	500	560	920	1030	-	DUT-1250-6-0-S	DUT-1100-6-0-S	SIN-1160-5-0-P	SIN-1160-5-0-P
SPX800A0-4...	560	630	1030	1150	-	DUT-1250-6-0-S	DUT-1250-6-0-S	SIN-1480-5-0-P	SIN-1160-5-0-P
SPX900A0-4...	630	710	1150	1300	-	DUT-1600-6-0-S	DUT-1600-6-0-S	SIN-1480-5-0-P	SIN-1480-5-0-P
SPXH10A0-4...	710	800	1300	1450	-	DUT-1600-6-0-S	DUT-1600-6-0-S	SIN-1480-5-0-P	SIN-1480-5-0-P
SPXH12A0-4...	900	1000	1600	1770	-	-	-	-	-
SPXH16A0-4...	1100	1200	1940	2150	-	-	-	-	-
690 V AC, 3-phase/690 V AC, 3-phase									
SPX002A1-5...	2.2	3	3.2	4.5	DX-LN3-006	DX-LM3-005	DX-LM3-005	SIN-0005-6-0-P	SIN-0005-6-0-P
SPX003A1-5...	3	4	4.5	5.5	DX-LN3-006	DX-LM3-008	DX-LM3-008	SIN-0008-6-0-P	SIN-0008-6-0-P
SPX004A1-5...	4	5.5	5.5	7.5	DX-LN3-010	DX-LM3-008	DX-LM3-008	SIN-0008-6-0-P	SIN-0008-6-0-P
SPX005A1-5...	5.5	7.5	7.5	10	DX-LN3-010	DX-LM3-011	DX-LM3-011	SIN-0014-6-0-P	SIN-0014-6-0-P
SPX007A1-5...	7.5	11	10	13.5	DX-LN3-016	DX-LM3-016	DX-LM3-016	SIN-0014-6-0-P	SIN-0014-6-0-P
SPX010A1-5...	11	15	13.5	18	DX-LN3-025	DX-LM3-035	DX-LM3-035	SIN-0023-6-0-P	SIN-0023-6-0-P
SPX015A1-5...	15	18.5	18	22	DX-LN3-025	DX-LM3-035	DX-LM3-035	SIN-0023-6-0-P	SIN-0023-6-0-P
SPX020A1-5...	18.5	22	22	27	DX-LN3-040	DX-LM3-035	DX-LM3-035	SIN-0035-6-0-P	SIN-0035-6-0-P
SPX025A1-5...	22	30	27	34	DX-LN3-040	DX-LM3-035	DX-LM3-035	SIN-0035-6-0-P	SIN-0035-6-0-P
SPX030A1-5...	30	37	34	41	DX-LN3-050	DX-LM3-035	DX-LM3-050	SIN-0052-6-0-P	SIN-0052-6-0-P
SPX040A1-5...	37	45	41	52	DX-LN3-080	DX-LM3-050	DX-LM3-063	SIN-0052-6-0-P	SIN-0052-6-0-P
SPX050A1-5...	45	55	52	62	DX-LN3-080	DX-LM3-063	DX-LM3-063	SIN-0085-6-0-P	SIN-0085-6-0-P
SPX060A1-5...	55	75	62	80	DX-LN3-080	DX-LM3-063	DX-LM3-080	SIN-0085-6-0-P	SIN-0085-6-0-P
SPX075A1-5...	75	90	80	100	DX-LN3-100	DX-LM3-080	DX-LM3-100	SIN-0122-6-0-P	SIN-0122-6-0-P
SPX100A1-5...	90	110	100	125	DX-LN3-160	DX-LM3-100	DX-LM3-150	SIN-0122-6-0-P	SIN-0185-6-0-P
SPX125A1-5...	110	132	125	144	DX-LN3-160	DX-LM3-150	DX-LM3-150	SIN-0185-6-0-P	SIN-0185-6-0-P
SPX150A1-5...	132	160	144	170	DX-LN3-200	DX-LM3-150	DX-LM3-180	SIN-0185-6-0-P	SIN-0185-6-0-P
SPX175A1-5...	160	200	170	208	DX-LN3-250	DX-LM3-180	DX-LM3-220	SIN-0287-6-0-P	SIN-0287-6-0-P
SPX200A0-5...	200	250	208	261	DX-LN3-300	DX-LM3-220	DX-LM3-303	SIN-0287-6-0-P	SIN-0287-6-0-P
SPX250A0-5...	250	315	261	325	-	DX-LM3-260	DX-LM3-450	SIN-0390-6-0-P	SIN-0390-6-0-P
SPX300A0-5...	315	355	325	385	-	DX-LM3-450	DX-LM3-450	SIN-0390-6-0-P	SIN-0390-6-0-P
SPX400A0-5...	355	450	385	460	-	DX-LM3-450	DUT-0590-6-0-S	SIN-0460-6-0-P	SIN-0460-6-0-P
SPX450A0-5...	450	500	460	502	-	DUT-0590-6-0-S	DUT-0590-6-0-S	SIN-0460-6-0-P	SIN-0620-6-0-P
SPX500A0-5...	500	560	502	590	-	DUT-0590-6-0-S	DUT-0590-6-0-S	SIN-0620-6-0-P	SIN-0620-6-0-P
SPX550A0-5...	560	630	590	650	-	DUT-0820-6-0-S	DUT-0820-6-0-S	SIN-0780-6-0-P	SIN-0780-6-0-P
SPX600A0-5...	630	710	650	750	-	DUT-0820-6-0-S	DUT-0820-6-0-S	SIN-0780-6-0-P	SIN-0780-6-0-P
SPX700A0-5...	710	800	750	820	-	DUT-1250-6-0-S	DUT-0820-6-0-S	SIN-0920-6-0-P	SIN-0920-6-0-P
SPX800A0-5...	800	900	820	920	-	DUT-1250-6-0-S	DUT-1250-6-0-S	SIN-1180-6-0-P	SIN-0920-6-0-P
SPX900A0-5...	900	1000	920	1030	-	DUT-1250-6-0-S	DUT-1250-6-0-S	SIN-1180-6-0-P	SIN-1180-6-0-P
SPXH10A0-5...	1000	1150	1030	1180	-	DUT-1250-6-0-S	DUT-1250-6-0-S	SIN-1180-6-0-P	SIN-1180-6-0-P
SPXH13A0-5...	1300	1500	1300	1500	-	DUT-1600-6-0-S	DUT-1600-6-0-S	-	-
SPXH15A0-5...	1500	1800	1500	1900	-	-	-	-	-
SPXH20A0-5...	1800	2000	1900	2250	-	-	-	-	-

SVX/SPX



## Soft Starter DS7 of System xStart – Soft at the Start, High on Torque

Soft starters have become a well-established alternative to the star-delta starter. This is where the DS7, featuring two-phase control and designed to work seamlessly with DILM and PKZ switchgear, comes in. The DS7 can be flexibly combined with other units and adds the ability to "start motors softly" to the switching, protection, and starting functions common to control panels. A patented method ensures that motor run-ups will be exceptionally soft while providing a higher torque than other available solutions. Longer service intervals and reduced operating costs are welcome side effects of this.

Designed for normal applications such as pumps, fans and small conveyors, the compact DS7 is ideal. The DS7 is also available with a SmartWire-DT connection to simplify wiring and enhance functionality as an automation solution.



#### System overview

DS7 soft starter < 32 A	98
DS7 soft starter > 32 A	100

#### Key to type references

DS7 soft starter	101
------------------	-----

#### Description

DS7 soft starter	102
------------------	-----

#### Ordering

DS7 soft starter	103
Accessories DS7	104

#### Engineering

General informationen on Engineering	108
Design with different load cycles	110
Connection examples	112
Assigned switching and protective elements DS7	114

System overview

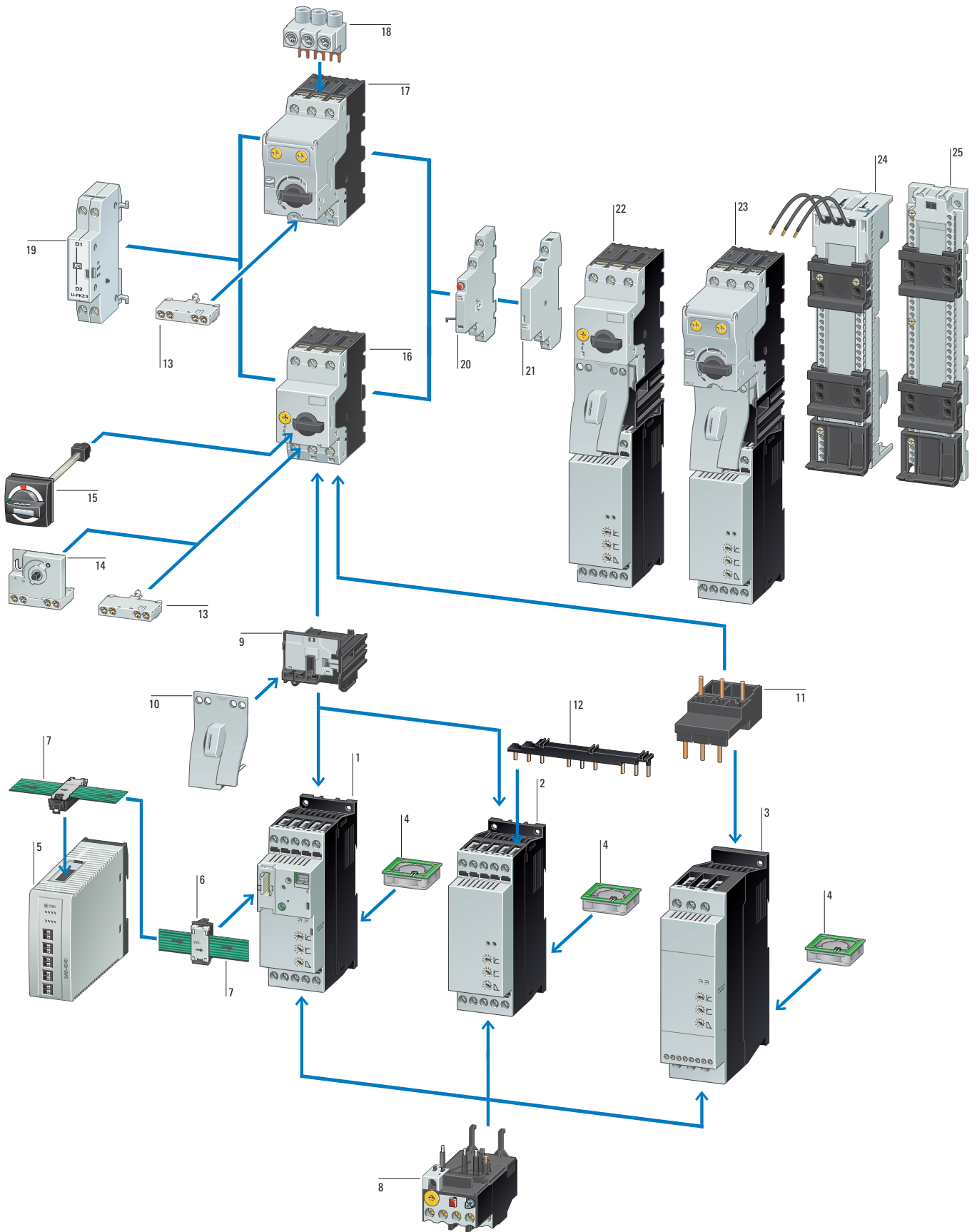

Soft starter DS7 with SmartWire-DT	1	Early-make auxiliary contact	14
→ page 103		→Industrial Switchgear catalog	
DS7 soft starters in construction size 1 for assigned motor current up to 12 A	2	Door coupling handle	15
→ page 103		→Industrial Switchgear catalog	
DS7 soft starters in construction size 2 for assigned motor current up to 32 A	3	PKZM0 motor-protective circuit-breakers	16
→ page 103		→Industrial Switchgear catalog	
DS7-FAN-32 device fan	4	PKE motor-protective circuit-breakers	17
→ page 107		→Industrial Switchgear catalog	
SmartWire-DT gateway	5	Connection clamp	18
→ page 148		→Industrial Switchgear catalog	
SmartWire-DT external device plug	6	voltage release	19
→ page 148		→Industrial Switchgear catalog	
SmartWire-DT flat band conductor	7	Indicator switch	20
→ page 148		→Industrial Switchgear catalog	
Overload relays	8	standard auxiliary contact	21
→Industrial Switchgear catalog		→Industrial Switchgear catalog	
PKZM0-XDM wiring set in tool-less plug connection	9, 10	Motor-starter combination with PKZ	22
→ page 105		→Industrial Switchgear catalog	
PKZM0-XM wiring set	11	Motor-starter combination with PKE	23
→ page 105		→Industrial Switchgear catalog	
three-phase commoning link	12	busbar adapter	24
→ page 106		→ page 105	
standard auxiliary contact	13	top-hat rail adapter	25
→Industrial Switchgear catalog		→ page 105	

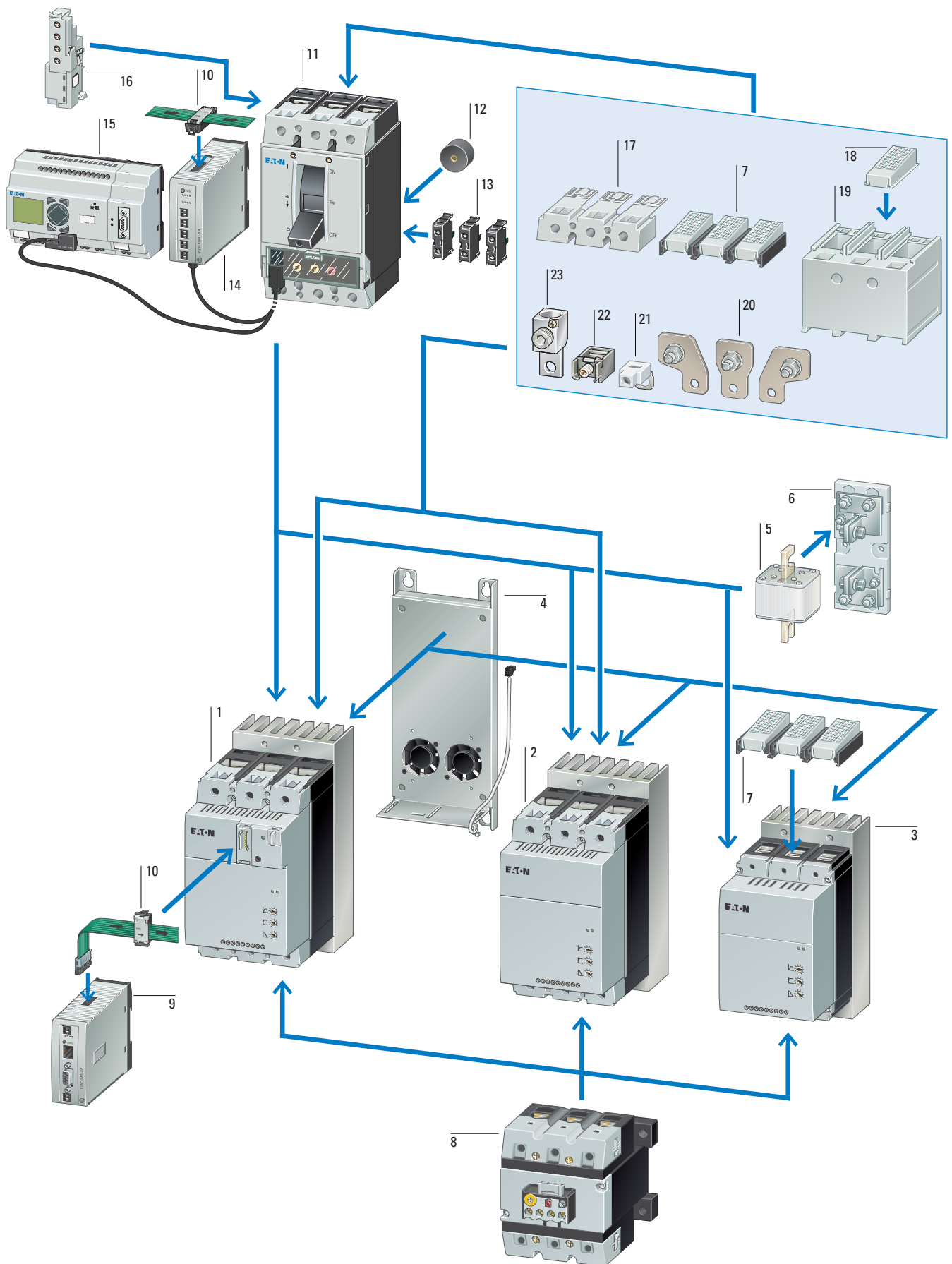

DS7 with SmartWire-DT	1
→ page 103	
DS7 size 4 up to 200 A	2
→ page 103	
DS7 size 3 up to 100 A	3
→ page 103	
Device fan	4
→ page 107	
Superfast semiconductor fuses	5
→ page 104	
Fuse bases for superfast semiconductor fuses	6
→ page 105	
IP2X protection against contact with a finger	7
→ page 107	
Overload relays	8
→Industrial Switchgear catalog	
Gateways for SmartWire-DT	9
→ page 148	
SmartWire-DT external device plug	10
→ page 148	
NZM circuit-breaker	11
→Industrial Switchgear catalog	
Spacer	12
→Industrial Switchgear catalog	

Standard auxiliary contact/Trip-indicating auxiliary switch	13
→Industrial Switchgear catalog	
NZM communication module for SmartWire-DT	14
→Industrial Switchgear catalog	
Data management interface (DMI module)	15
→Industrial Switchgear catalog	
Voltage release/Early-make auxiliary contact	16
→Industrial Switchgear catalog13	
Terminal cover for terminals	17
→ page 106	
IP2X protection against contact with a finger	18
→ page 107	
Terminal cover for cable lugs	19
→ page 106	
Connection width extension	20
→Industrial Switchgear catalog	
Control circuit terminal	21
→Industrial Switchgear catalog	
Box terminals	22
→Industrial Switchgear catalog	
Tunnel terminals for Al and Cu cable	23
→Industrial Switchgear catalog	

**Key to type references**

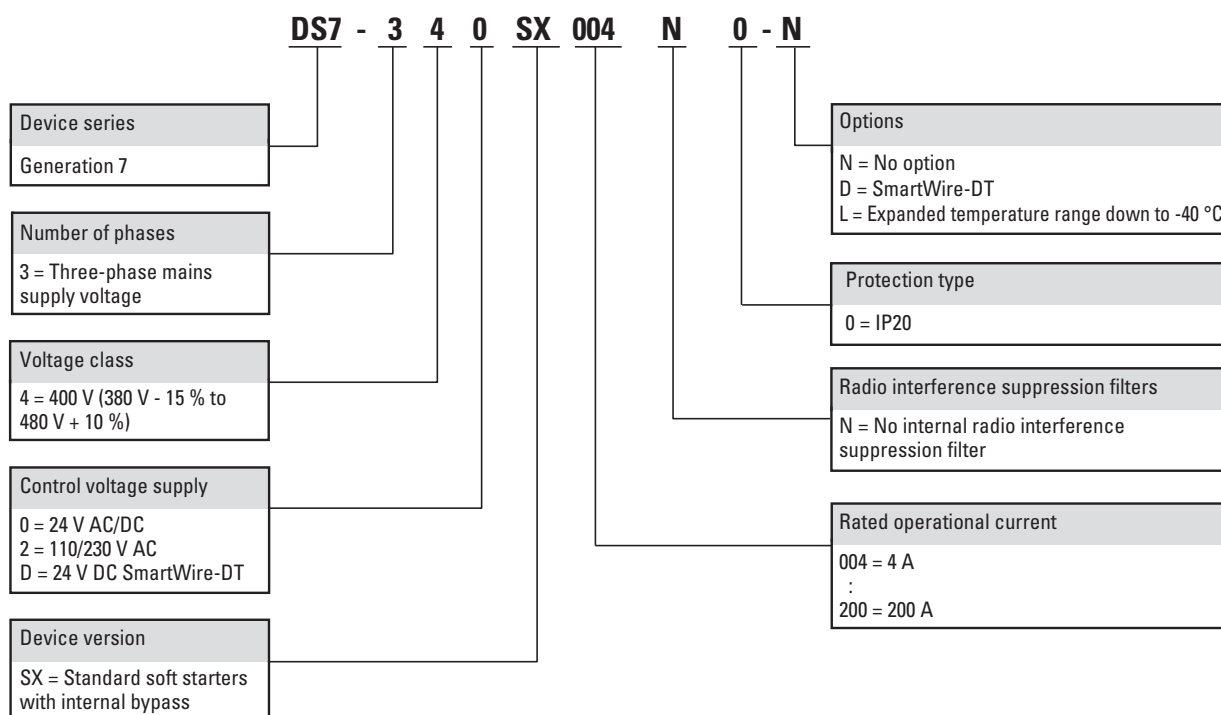

DS7

## Description



### Application

The DS7 series soft starters are two-phase controlled soft starters used for soft starting three-phase AC motors for applications with a normal operating frequency and a performance range of 3 to 200 A (1.1 to 110 kW with a 400 V mains voltage). Closing transients and DC components during startup are effectively suppressed and guarantee even motor starting.

The special actuation method (asymmetrical trigger phase control) for the soft starter function avoids the DC components (Eaton patent) that would normally occur in two-phase-controlled soft starters. This suppresses the generation of an elliptical rotating field, which would cause uneven motor starting and increase the motor's acceleration. The true run behavior of the DS7 is therefore comparable with that of a three-phase controlled soft starter.

### Functions

Typical fields of application for Series DS7 soft starters are:

- Pump drives: pressure surges are prevented through soft starting. The mechanical load on the whole plant is reduced and its service life increases.
- Fan drives: soft starting keeps fan belts from slipping, preventing premature wear. This lowers operating costs and extends the system's lifespan.
- Conveyor belts: conveyor belts start running smoothly, instead of starting with a jolt. This ensures that any goods being conveyed do not topple over. Mechanical damage to the belt itself is avoided, making it more durable.

### Features

- The ramp time can be adjusted by potentiometer within a range of 1 to 30 s (for starting) or 0 to 30 s (for stopping) with a potentiometer
- The start voltage (or start torque) can be adjusted within a range of 30 to 100 percent of the mains voltage with a potentiometer
- Significant reduction in switch-on current, achieved with a short soft start ramp time (min. 1 s) for lamp and heating loads
- Internal bypass relay: switches on automatically after the end of the ramp, bypassing the internal thyristors.
- This makes it possible to comply with radio interference level B without any additional measures.
- The motor's thermal load is smaller than it would be without asymmetric ignition control.
- Designed specifically for long cables

### Documentation

Surface mounting and standard mounting procedures are described in the corresponding mounting instructions and in the manual.

Instructional leaflets:

- IL03902003Z: for size 1 devices (up to 12 A motor output)
- IL03902004Z: for size 2 devices (up to 32 A motor output)
- IL03902005Z: for size 3, 4 devices (up to 200 A motor output)

Manual:  
MN03901001Z

You can download the documentation for the DS7 soft starters from the Internet at: [www.moeller.net/support](http://www.moeller.net/support)

### Communication interface SmartWire-DT

Our SmartWire-DT interface completely eliminates the need for conventional control wiring. This has several advantages:

- No incorrect wiring
- Faster wiring
- Cost saving

The interface can be used to send control commands to the DS7-SWD and change and diagnose its parameter configuration; in addition, the control electronics can be powered via the SmartWire-DT cable. The device is controlled with one of three selectable profiles:

- A "start/stop" profile, which should already be familiar from the PKE motor-protective circuit-breaker and contactor combination
- An 8 bit-wide profile for the soft starter, which is provided the same way for the variable frequency drive and features more options
- A control profile comparable to a PROFIdrive profile, just like the one available for the variable frequency drive.

Regardless of the profile chosen, the DS7-SWD's parameters can be read and written to at any time by using acyclic services.

DS7-SWD makes it possible to read and write to all device parameters. The mechanisms of the parameter channel that is described for the drives in the PROFIdrive profile are used for this purpose. This profile provides a standardized parameter access method for variable frequency drives and soft starters.

It is also possible to overwrite the potentiometer settings on the DS7-SWD, which can come in handy, for instance, when a change made to the machine needs to be undone.

The DS7-SWD comes with a detailed diagnostic system with options that extend far beyond those of wired devices. In addition to having an error log, the DS7-SWD can detect and report nine different device faults. A warning parameter reports any present alarm messages. Moreover, the response to each individual fault can be customized. Finally, there are 35 additional messages for communication errors. Using the DS7 in connection with the PKE opens up new functionalities that were previously thought impossible to implement with a low-cost soft starter and that were reserved to significantly more expensive devices. Combining a PKE unit and a DS7-SWD makes it possible to completely protect the DS7-SWD device against overloads. In addition, it provides a current limiting function and can report thermal capacity utilization levels to higher level controllers.

### Expanded temperature range

DS7-340SX...-L soft starters can operate at temperatures as low as -40 °C.



Ordering

Rated operational current Device (AC-53) I <sub>e</sub> A	Assigned motor rating		Part no.	Article no.	Price see price list	Part no.	Article no.	Price see price list	Std. pack
	at 400 V, 50 Hz	at 460 V, 60 Hz							
	P kW	P HP	U <sub>C</sub> 24 V AC/DC U <sub>S</sub> 24 V AC/DC Standard temperature range			U <sub>C</sub> 24 V AC/DC U <sub>S</sub> 24 V AC/DC Expanded temperature range down to -40 °C			

Soft starters

Soft starters for three-phase loads  
Mains supply voltage (50/60 Hz)  
U<sub>LN</sub> 200 - 480 V AC

4	1.5	2	DS7-340SX004N0-N	134847		DS7-340SX004N0-L	171740		1 off 
7	3	5	DS7-340SX007N0-N	134849		DS7-340SX007N0-L	171741		
9	4	5	DS7-340SX009N0-N	134910		DS7-340SX009N0-L	171742		
12	5.5	10	DS7-340SX012N0-N	134911		DS7-340SX012N0-L	171743		
16	7.5	10	DS7-340SX016N0-N	134912		DS7-340SX016N0-L	171744		
24	11	15	DS7-340SX024N0-N	134913		DS7-340SX024N0-L	171745		
32	15	25	DS7-340SX032N0-N	134914		DS7-340SX032N0-L	171746		
41	22	30	DS7-340SX041N0-N	134916		DS7-340SX041N0-L	171747		
55	30	40	DS7-340SX055N0-N	134917		DS7-340SX055N0-L	171748		
70	37	50	DS7-340SX070N0-N	134918		DS7-340SX070N0-L	171749		
81	45	60	DS7-340SX081N0-N	134919		DS7-340SX081N0-L	171750		
100	55	75	DS7-340SX100N0-N	134920		DS7-340SX100N0-L	171751		
135	75	100	DS7-340SX135N0-N	134921		DS7-340SX135N0-L	171752		
160	90	125	DS7-340SX160N0-N	134922		DS7-340SX160N0-L	171753		
200	110	150	DS7-340SX200N0-N	134923		DS7-340SX200N0-L	171754		

U<sub>C</sub> 110 - 230 V AC  
U<sub>S</sub> 110 - 230 V AC

U<sub>C</sub> 24 V DC  
U<sub>S</sub> 24 V DC



4	1.5	2	DS7-342SX004N0-N	134925		DS7-34DSX004N0-D	134943		1 off 
7	3	5	DS7-342SX007N0-N	134927		DS7-34DSX007N0-D	134945		
9	4	5	DS7-342SX009N0-N	134928		DS7-34DSX009N0-D	134946		
12	5.5	10	DS7-342SX012N0-N	134929		DS7-34DSX012N0-D	134947		
16	7.5	10	DS7-342SX016N0-N	134930		DS7-34DSX016N0-D	134948		
24	11	15	DS7-342SX024N0-N	134931		DS7-34DSX024N0-D	134949		
32	15	25	DS7-342SX032N0-N	134932		DS7-34DSX032N0-D	134950		
41	22	30	DS7-342SX041N0-N	134934		DS7-34DSX041N0-D	134952		
55	30	40	DS7-342SX055N0-N	134935		DS7-34DSX055N0-D	134953		
70	37	50	DS7-342SX070N0-N	134936		DS7-34DSX070N0-D	134954		
81	45	60	DS7-342SX081N0-N	134937		DS7-34DSX081N0-D	134955		
100	55	75	DS7-342SX100N0-N	134938		DS7-34DSX100N0-D	134956		
135	75	100	DS7-342SX135N0-N	134939		DS7-34DSX135N0-D	134957		
160	90	125	DS7-342SX160N0-N	134940		DS7-34DSX160N0-D	134958		
200	110	150	DS7-342SX200N0-N	134941		DS7-34DSX200N0-D	134959		

Notes

Information relevant for export to North America  
UL/CSA applies only for DS7...-N

Product Standards IEC/EN 60947-4-2; GB 14048.6; UL 508;  
CSA-C22.2 No 0-M91;  
CSA-C22.2 No 14-05 CE marking  
UL File No. E251034  
CSA File No. 2511305  
CSA Class No. 321106  
Suitable for Branch circuits  
Max. Voltage Rating 480 V  
Degree of Protection IP20; UL/CSA Type 1

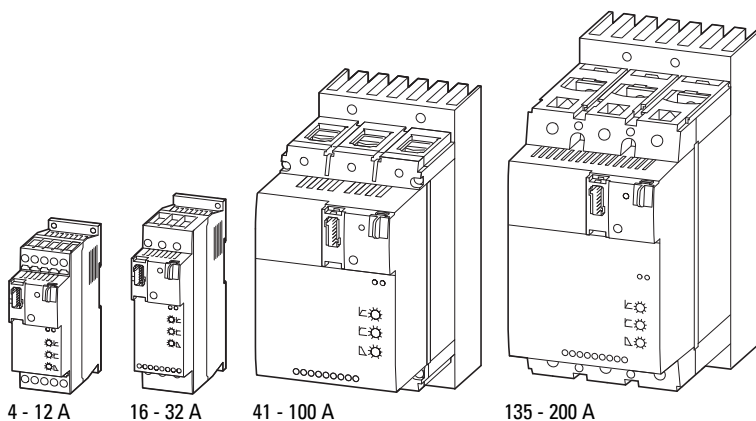



4 - 12 A







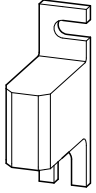

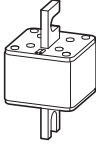
16 - 32 A

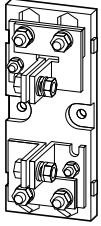

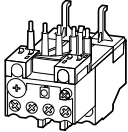

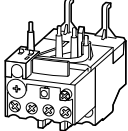
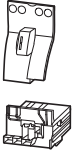



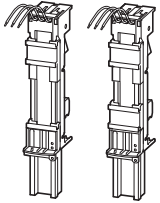
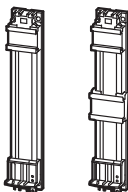



41 - 100 A

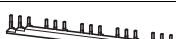
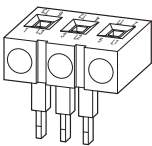

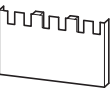

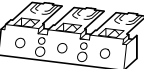

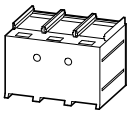
135 - 200 A

DS7

	Rated device current	Maximum power loss $P_v$ W	Frame size	For use with	Part no. Article no.	Price see price list	Std. pack	Information relevant for export to North America 	
<b>Superfast semiconductor fuses</b>									
DIN 43653, 690/700 V (IEC/UL) Inside micrometer 80 mm									
	16	5.5	000	DS7-34...SX004N0-...	<b>170M1359</b> 171968		<b>10 off</b> 	Product Standards IEC/EN 60269-4; UL 248-1; CSA-C22.2 No. 248.14; CE marking E125085	
	25	9	000	DS7-34...SX007N0-...	<b>170M1361</b> 171969				
	32	10	000	DS7-34...SX009N0-... DS7-34...SX012N0-...	<b>170M1362</b> 171970				
	40	12	000	DM4-340-7K5	<b>170M1363</b> 171971				
	50	15	000	DS4-340-2K2-M DS4-340-2K2-MR DS4-340-2K2-M-DC DS7-34...SX016N0-...	<b>170M1364</b> 171972				
	63	16	000	DS4-340-4K0-M DS4-340-4K0-MR DS4-340-7K5-MX DS4-340-7K5-MXR DS7-34...SX024N0-...	<b>170M1365</b> 171973				
	80	19	000	DS4-340-5K5-M DS4-340-5K5-MR DS4-340-11K-MX DS4-340-11K-MXR DS7-34...SX032N0-...	<b>170M1366</b> 171974				
	100	21	S1*	DS6-340-22K-MX	<b>170M3012</b> 171976				
		125	26	S1*	DS4-340-7K5-M DS4-340-7K5-MR DS4-340-15K-MX DS4-340-15K-MXR DM4-340-22K DM4-340-30K DS7-34...SX041N0-... DS7-34...SX055N0-...	<b>170M3013</b> 173799			
		160	30	S1*	DS4-340-11K-M DS4-340-11K-MR	<b>170M3014</b> 171977			
200		45	S1	DM4-340-37K DM4-340-45K DS6-340-37K-MX DS6-340-45K-MX DS6-340-55K-MX DS7-34...SX070N0-... DS7-34...SX081N0-... DS7-34...SX100N0-...	<b>170M4008</b> 171978				
315		58	S1	DS6-340-75K-MX DS7-34...SX135N0-...	<b>170M4010</b> 171979				
350		60	S1	DM4-340-55K DM4-340-75K	<b>170M4011</b> 171980				
400		65	S2	DS6-340-90K-MX DS7-34...SX160N0-...	<b>170M5008</b> 171984				
450		70	S1	DM4-340-90K DM4-340-110K	<b>170M4013</b> 171981				
500		72	S1	DM4-340-132K DM4-340-160K	<b>170M4014</b> 171982				
500		95	S3	DS6-340-110K-MX DS7-34...SX200N0-... DM4-340-132K DM4-340-160K	<b>170M6008</b> 171985				
630		80	S1	DM4-340-200K	<b>170M4016</b> 171983				
900	120	S3	DM4-340-250K DM4-340-315K	<b>170M6013</b> 171986					
1250	140	S3	DM4-340-400K DM4-340-500K	<b>170M6016</b> 171987					

	For use with	Part no. Article no.	Price see price list	Std. pack	Information relevant for export to North America 
<b>Fuse Bases</b>					
	Dimensions (W x H x D) mm 145 x 43 x 50	000, 00	<b>170H1007</b> 171988	3 off 	Product Standards IEC/EN 60269-1; UL 512; CE marking UL File No. E14853 UL Category Control No. IZLT2 North America Certification UL listed Suitable for DIN 43653 fuses
	205 x 88 x 80	S1*, S1, S2, S3	<b>170H3004</b> 171989		
<b>Overload relays</b>					
	DS7-34...SX004...		<b>ZB12-4</b> 278438	1 off 	Product Standards UL 508; CSA-C22.2 No. 14; IEC/EN 60947-4-1; IEC/EN 60947-5-1; CE marking UL File No. E29184 UL Category Control No. NKCR CSA File No. 12528 CSA Class No. 3211-03 North America Certification UL listed, CSA certified Suitable for Branch circuits Max. Voltage Rating 600 V AC Degree of Protection IEC: IP20, UL/CSA Type: -
	DS7-34...SX007... DS7-34...SX009... DS7-34...SX012...		<b>ZB12-10</b> 278440 <b>ZB12-12</b> 278441		
	DS7-34...SX016...		<b>ZB32-16</b> 278452		
	DS7-34...SX024...		<b>ZB32-24</b> 278453		
	DS7-34...SX032...		<b>ZB32-32</b> 278454		
<b>Wiring set</b>					
For DOL Starter					
	DS7-34...SX004... DS7-34...SX007... DS7-34...SX009... DS7-34...SX012...		<b>PKZM0-XDM12</b> 283149	1 off 	Product Standards UL 508; CSA-C22.2 No. 14; IEC60947-4-1; CE marking UL File No. E36332 UL Category Control No. NLRV CSA File No. 165628 CSA Class No. 3211-05 North America Certification UL listed, CSA certified
	<b>Electric contact module</b>				
	DS7-34...SX016... DS7-34...SX024... DS7-34...SX032...		<b>PKZM0-XM32DE</b> 239349	5 off 	Product Standards UL 508; CSA-C22.2 No. 14; IEC60947-4-1; CE marking UL File No. E36332 UL Category Control No. NLRV CSA File No. 165628 CSA Class No. 3211-05 North America Certification UL listed, CSA certified
<b>Busbar adapters</b>					
	PKZM0, PKE + DS7...004N... PKZM0, PKE + DS7...007N... PKZM0, PKE + DS7...009N... PKZM0, PKE + DS7...012N...		<b>BBA0L-25</b> 142526	1 off	
	PKZM0, PKE + DS7...016N... PKZM0, PKE + DS7...024N... PKZM0, PKE + DS7...032N...		<b>BBA0L-32</b> 142527	1 off	
<b>Top-hat rail adapter</b>					
45 mm wide adapter plate					
	PKZM0, PKE + DS7...004N... PKZM0, PKE + DS7...007N... PKZM0, PKE + DS7...009N... PKZM0, PKE + DS7...012N...		<b>PKZM0-XC45L</b> 142529	1 off	
	PKZM0, PKE + DS7...016N... PKZM0, PKE + DS7...024N... PKZM0, PKE + DS7...032N...		<b>PKZM0-XC45L/2</b> 142570	1 off	

For use with	Part no. Article no.	Price see price list	Std. pack	Notes	Information relevant for export to North America 
<b>Three-phase commoning links</b>					
protected against accidental contact, short-circuit proof, $U_e = 690\text{ V}$ , $I_u = 35\text{ A}$ can be extended by rotating installation ( $\sum I_u \leq 35\text{ A}$ )					
	DS7-34...SX004... DS7-34...SX007... DS7-34...SX009... DS7-34...SX012...	<b>DILM12-XDSB0/3</b> 240084	5 off 	For the primary side of DS7 Suitable for 3 DS7 soft starters Length 112 mm	Product Standards IEC/EN 60947-4-1; UL 508; CSA-C22.2 No. 14-05; CE marking E36332
		<b>DILM12-XDSB0/4</b> 240085		For the primary side of DS7 Suitable for 4 DS7 soft starters Length 157 mm	UL File No. UL Category Control No. NLRV CSA File No. 012528 CSA Class No. 2411-03
		<b>DILM12-XDSB0/5</b> 240086		For the primary side of DS7 Suitable for 5 DS7 soft starters Length 202 mm	North America Certification UL listed, CSA certified
<b>Incoming connection block</b>					
	DS7-34...SX004... DS7-34...SX007... DS7-34...SX009... DS7-34...SX012...	<b>DILM12-XEK</b> 240083	5 off 	For three-phase commoning link, protected against accidental contact, $U_e = 690\text{ V}$ , $I_u = 35\text{ A}$ . Connection cross section: Stranded 2.5...16 mm <sup>2</sup> Flexible with ferrule 2.5...16 mm <sup>2</sup> AWG14...8	Product Standards IEC/EN 60947-4-1; UL 508; CSA-C22.2 No. 14-05; CE marking E36332 UL File No. UL Category Control No. NLRV CSA File No. 012528 CSA Class No. 2411-03 North America Certification UL listed, CSA certified
<b>Terminal cover</b>					
Type contains parts for a terminal located at top or bottom for 3 pole circuit-breakers.					
knockout For box terminal 	DS7-34...SX041... DS7-34...SX055... DS7-34...SX070... DS7-34...SX081... DS7-34...SX100...	<b>NZM1-XKSFA</b> 100780	1 off 	Enhancement of the busbar tag shroud (simple protection against contact with a finger). Cannot be combined with NZM-XSTK control circuit terminal.	UL/CSA certification not required
knockout 	DS7-34...SX135... DS7-34...SX160... DS7-34...SX200...	<b>NZM2-XKSFA</b> 104640	1 off 	Enhancement of the busbar tag shroud (simple protection against contact with a finger). Protection when reaching into the cable connection area with the connection of cables in the box terminal. With 2 conductors max cross section 22 mm <sup>2</sup> or AWG4. Cannot be combined with NZM-XSTK control circuit terminal.	UL/CSA certification not required
	DS7-34...SX135... DS7-34...SX160... DS7-34...SX200...	<b>NZM2-XKSA</b> 260038	1 off 	Busbar tag shroud where cable lugs, busbars or tunnel terminals are used. When using insulated conductor material to IP1X.	Product Standards UL489; CSA-C22.2 No. 5-09; IEC60947, CE marking E31593 UL File No. UL Category Control No. DIHS CSA File No. 22086 CSA Class No. 1432-01 North America Certification UL listed, CSA certified Suitable for Refer to main component information

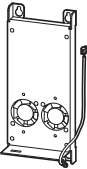
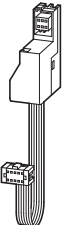
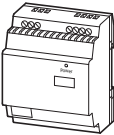
For use with	Part no. Article no.	Price see price list	Std. pack	Notes	Information relevant for export to North America 
<b>IP2X protection against contact with a finger</b>					
Type contains parts for a terminal located at top or bottom for 3 pole circuit-breakers. Enhancement of the busbar tag shroud to IP2X.					
For box terminal 	NZM2, PN2, N2	<b>NZM2-XIPK</b> 266773	1 off 	Protection when reaching into the cable connection area with the connection of cables in the box terminal. With 2 conductors max cross section 25 mm <sup>2</sup> or AWG4. Cannot be combined with NZM-XSTK control circuit terminal.	UL/CSA certification not required
for cover NZM2-XKSA or NZM2 or NZM2...(C)NA und N(S)2...NA 	NZM2, PN2, N(S)2	<b>NZM2-XIPA</b> 266777	1 off 	When mounting NZM2...-(C)NA or NZM2...-NA the following applies: with 2 conductors max cross section 25 mm <sup>2</sup> or AWG4.	UL/CSA certification not required
<b>Mounting kit</b>					
when using covers NZM1-XKSFA and NZM2-XKSA					
	DS7-34xSX041N0-x DS7-34xSX055N0-x DS7-34xSX070N0-x DS7-34xSX081N0-x DS7-34xSX100N0-x DS7-34xSX135N0-x DS7-34xSX160N0-x DS7-34xSX200N0-x	<b>DE6-MNT-NZM</b> 107323	1 off	-	
<b>Device fans</b>					
flush-mounted fan					
	DS7-34...SX004... DS7-34...SX007... DS7-34...SX009... DS7-34...SX012... DS7-34...SX016... DS7-34...SX024... DS7-34...SX032...	<b>DS7-FAN-032</b> 135553	1 off 	flush-mounted fan	UL/CSA certification not required
	DS7-34...SX041... DS7-34...SX055... DS7-34...SX070... DS7-34...SX081... DS7-34...SX100...  DS7-34...SX135... DS7-34...SX160... DS7-34...SX200...	<b>DS7-FAN-100</b> 169021  <b>DS7-FAN-200</b> 169022		Bottom fans	
<b>PKE communications cable</b>					
6-Pole Prefabricated with two plugs For connecting the PKE to DS7-SWD					
	DS7...SWD	<b>PKE32-COM</b> 168970	1 off		
<b>Switched-mode power supply units easyPOW</b>					
1-phase Nominal input voltage 100 - 240 V AC Rated output voltage 24 V DC (± 3%) Rated output current 1.25 A					
		<b>EASY400-POW</b> 212319	1 off		

## Engineering

### Generalized phase control of motor voltage

By means of generalized phase control, the soft starter adjusts the grid's voltage ( $U_{LN}$ ) smoothly from an adjustable start value to 100 % of the rated value  $U_{LN}$ .

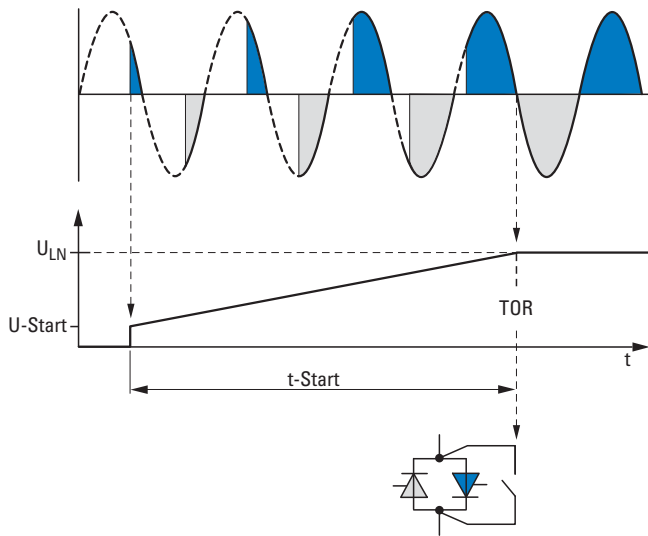

$U_{LN}$ : Mains supply voltage

U-Start: start voltage

t-Start: Ramp time of the voltage change at start

TOR (Top of Ramp): Signals the end of the set "t-Start" ramp time (output voltage  $U_2$  = Mains supply voltage  $U_{LN}$ ). The internal bypass contacts are closed after this.

This voltage control enables the inrush current of a three-phase asynchronous motor to be limited and its starting torque to be reduced. This enables a smooth and jerk-free increase in torque, adjusted in line with the machine's load behavior. This has a positive effect on the lifespan, operating behavior, and operating processes of the mechanical equipment and prevents negative effects such as:

- Impacting of cog edges in the gearbox
- Pressure surge in pipe systems (water impact),
- Slipping of V belts or
- Jitter with conveyor systems.

In DS7 and S801+/S811+ series soft starters, generalized phase control is achieved with anti-parallel thyristors that are bypassed for continuous operation by using bypass contacts (TOR = Top Of Ramp) after the time for a time-triggered voltage change (t-Start) has elapsed. The transition resistance of these bypass contacts is considerably lower than the transition resistance of the power semiconductors. This reduces the heat dissipation in the soft starter and extends the lifespan of the power semiconductors.

As well as the time-controlled startup of a motor, the soft starter also enables a time-controlled reduction of the motor voltage and thus a controlled stopping of the motor.

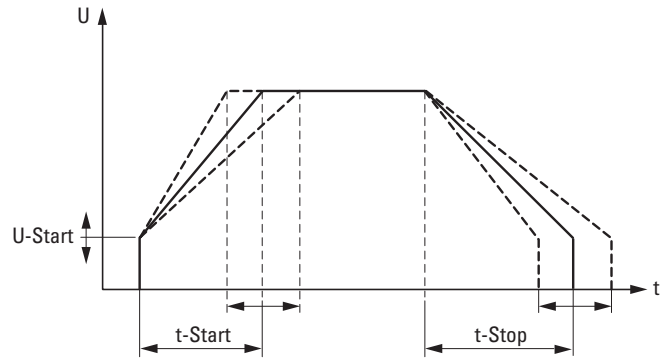

The output voltage of a soft starter determines the torque of the motor ( $M \sim U^2$ ). Because of this, it is necessary to make sure that, when a machine starts up, the selected U-Start start voltage is not too low and the t-Start ramp time for the linear voltage change is set to be as short as possible.

Please note:

- Long ramp times (t-Start) will produce a soft startup behavior, but will also result in a higher thermal load on the thyristors
- A high start voltage (U-Start) will produce a higher torque and a high starting current
- Set the lowest possible start voltage and the shortest possible start ramps.

The following pages include application and setting configuration examples for DS7 soft starters.

If controlled deceleration is required, t-Stop must be set to a longer time than would be necessary for the machine to coast freely based on the load. For the thyristors, the controlled deceleration constitutes a load comparable to that produced during startup. If, for example, the deceleration ramp is activated on a soft starter with a maximum of 10 permissible starts per hour, the number of permissible starts will be reduced to five per hour (plus five stops within that hour).

Selection criteria

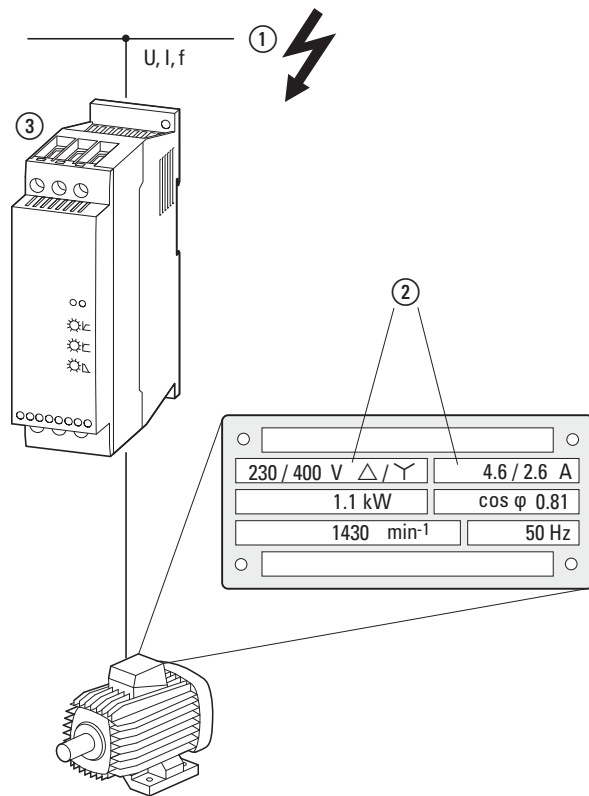

Soft starters ③ are selected based on the supply voltage of the corresponding grid ① (ULN) and the rated operational current of the assigned motor ②. The motor's circuit configuration (Δ/Y) must be selected in such a way that it matches the supply voltage. In addition, the soft starter's rated operational current (I<sub>e</sub>) must be at least equal to that of the motor.

Additional selection criteria include:

- Ambient air temperature (rated value +40 °C)
- The number of starts per hour (< 10 starts, take stops into account)
- Load torque (quadratic, linear)
- Starting torque

Centrifugal pumps, centrifugal fans, simple and smooth-running conveyor belts and traction drives, and circular saws and ribbon saws are some of the typical applications for which soft starters are used. Reciprocating compressors, mixers, mills, crushers, and lifting gear are instead categorized as heavy starting duty machines. In this case, the soft starter must be oversized in terms of its overload capacity.

In the case of applications that are typical for a soft starter, such as water pumps (centrifugal pumps), and that feature comparable operational data (operating frequency, run-up time, and/or inrush currents) a soft starter can be assigned directly to the motor on the basis of the rated operational current.

Example:

- 15 kW Pump motor
- 400 V
- Rated operational current 29 A
- About three times the starting current (I<sub>LRP</sub> = 87 A),
- A maximum of 10 starts per hour
- 5-second start-up time
- ambient air temperature 40 °C.

=> DS7-34...032... (I<sub>e</sub> = 32 A)

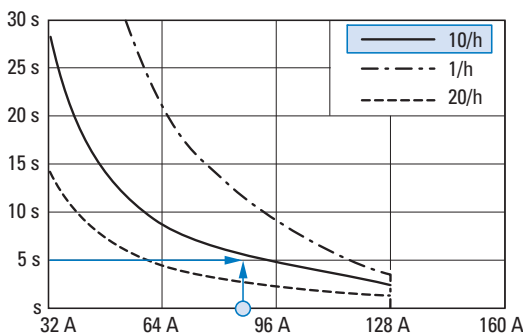

When different operating frequencies, run-up times and/or starting currents are involved, the thermal capacity of the DS7 soft starter must be taken into account in the design. This can be done by using the following diagrams or by calculating the I<sup>2</sup>t values. These I<sup>2</sup>t values define the corresponding load capacity and overload cycle and are defined in product standard IEC/EN 60947-4-2.

DS7-34...SX032...soft starter:

- 32A: AC-53a: 3-5: 75-10
- Rated operational current (I<sub>e</sub>) 32 A
- Load cycle AC-53a
- 300% overcurrent for 5 seconds
- 75% duty factor with 10 starts per hour

The resulting I<sup>2</sup>t value is: (3 x 32 A)<sup>2</sup> x 5 s = 46.080 A<sup>2</sup>s

The maximum I<sup>2</sup>t value of the connected motor load must be smaller:

(3 x 29 A)<sup>2</sup> x 5 s = 37.845 A<sup>2</sup>s

Soft starter DS7-34...SX032... is the right choice for this application.

If the motor had a higher inrush current, e.g., 5 times the starting current, a more powerful soft starter would have to be selected:

- Motor inrush current: I<sub>LRP</sub> = 5 x 29 = 145 A, I<sup>2</sup>t value = (5 x 29 A)<sup>2</sup> x 5 s = 105.125 A<sup>2</sup>s

DS7-34...SX041...: 41A:

AC-53a: 3-5: 75-10

=> (3 x 41 A)<sup>2</sup> x 5 s = 75.645 A<sup>2</sup>s

Soft starter DS7-34...SX041... cannot meet the required startup and load conditions required in this case.

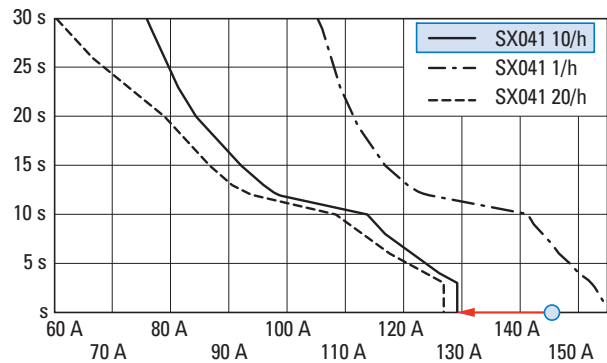

DS7-34...SX055...:

55A: AC-53a: 3-5: 75-10

=> (3 x 55 A)<sup>2</sup> x 5 s = 136.125 A<sup>2</sup>s

Soft starter DS7-34...SX055... however, does meet the required startup and load conditions.

Note: As the following diagram shows, the DS7-34...SX055... unit can handle even more demanding startup and load requirements, e.g., up to 20 starts per hour and longer start-up times (up to 10 seconds).

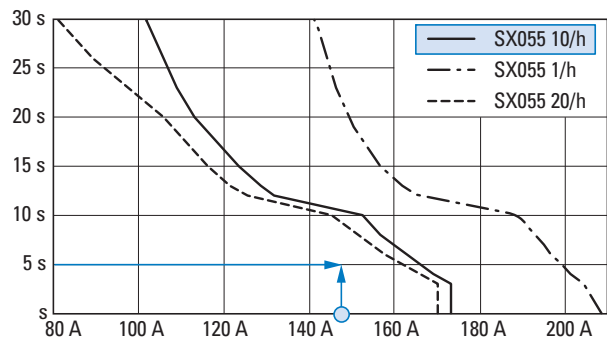

DS7

DS7-34...SX004...

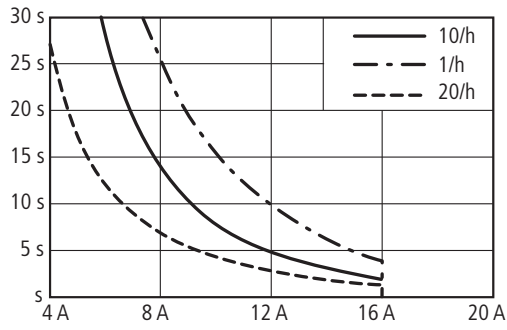

DS7-34...SX007...

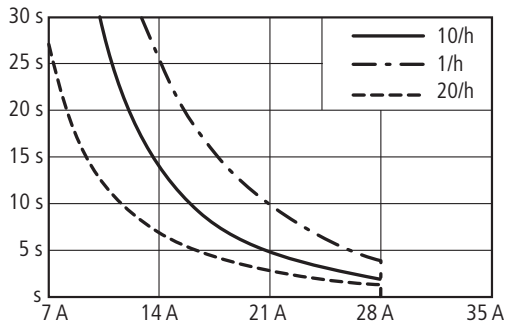

DS7-34...SX009...

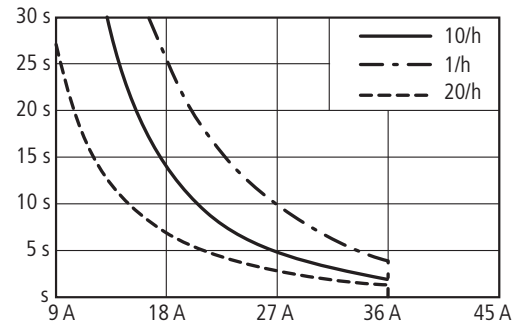

DS7-34...SX012...

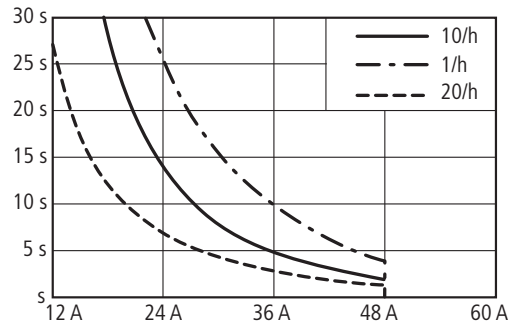

DS7-34...SX016...

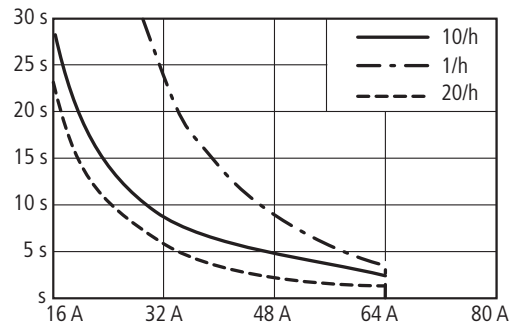

DS7-34...SX024...

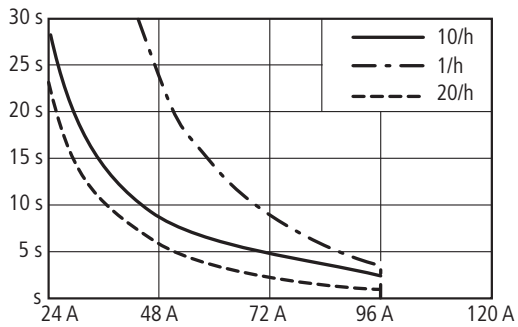

DS7-34...SX032E...

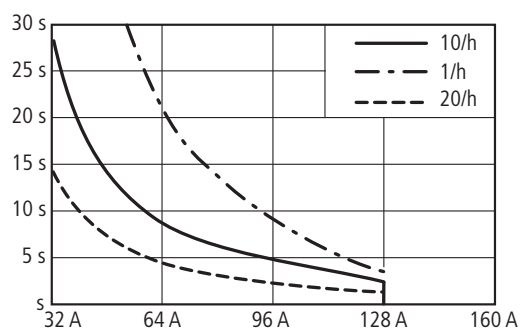



DS7-34...SX041N0-...

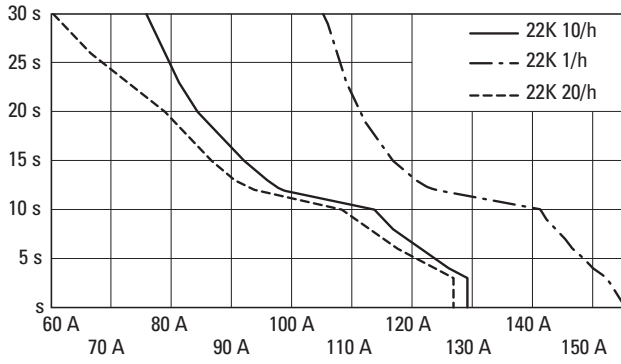

DS7-34...SX055N0-...

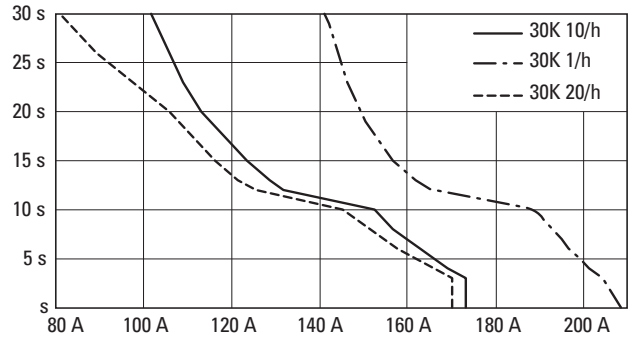

DS7-34...SX070N0-...

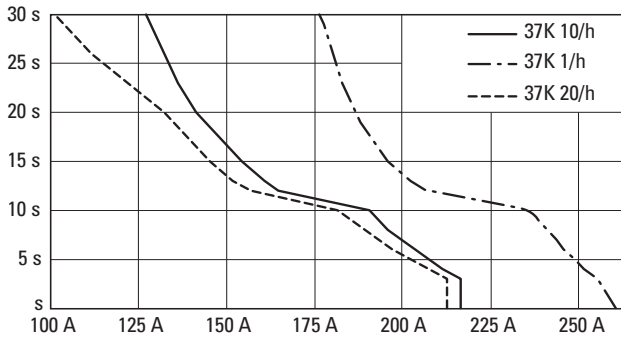

DS7-34...SX081N0-...

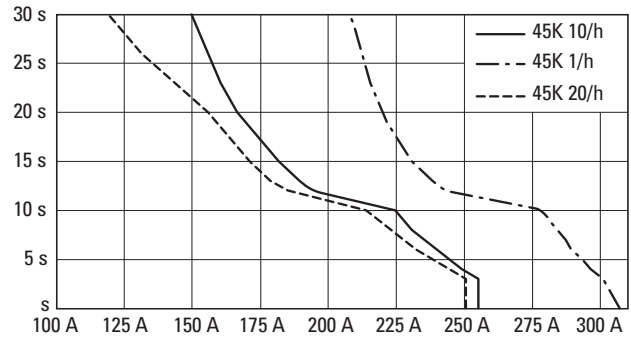

DS7-34...SX100N0-...

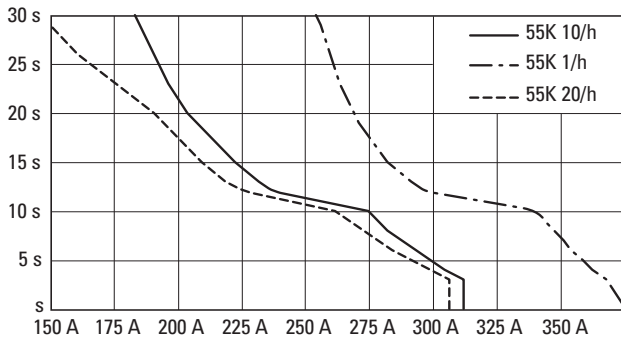

DS7-34...SX135N0-...

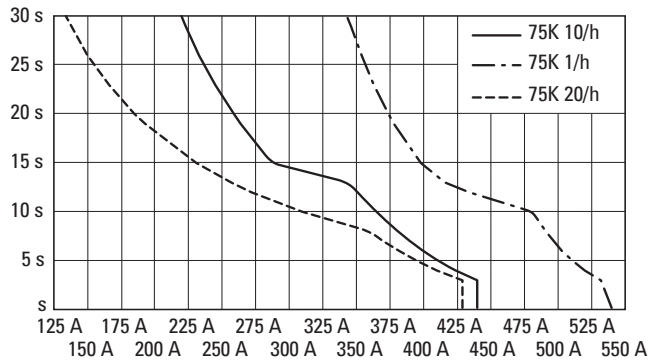

DS7-34...SX160N0-...

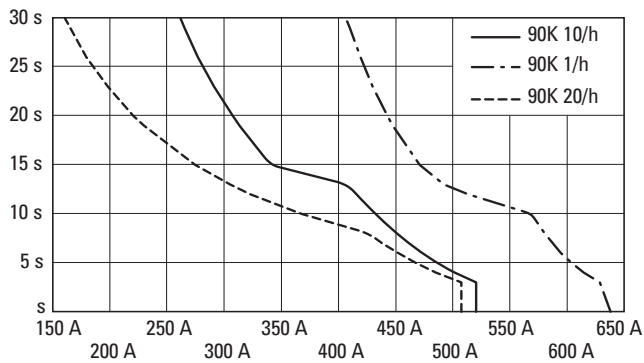

DS7-34...SX200N0-...

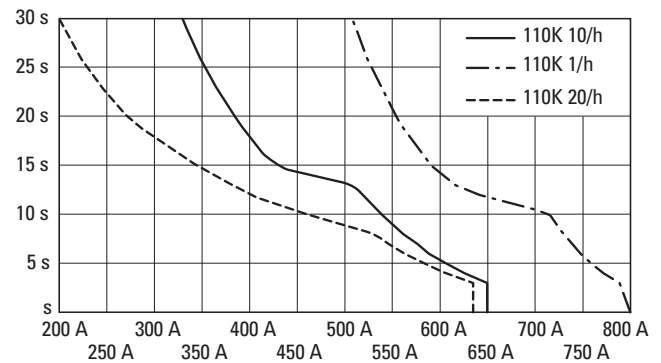

DS7

Standard connection

up to 12 A

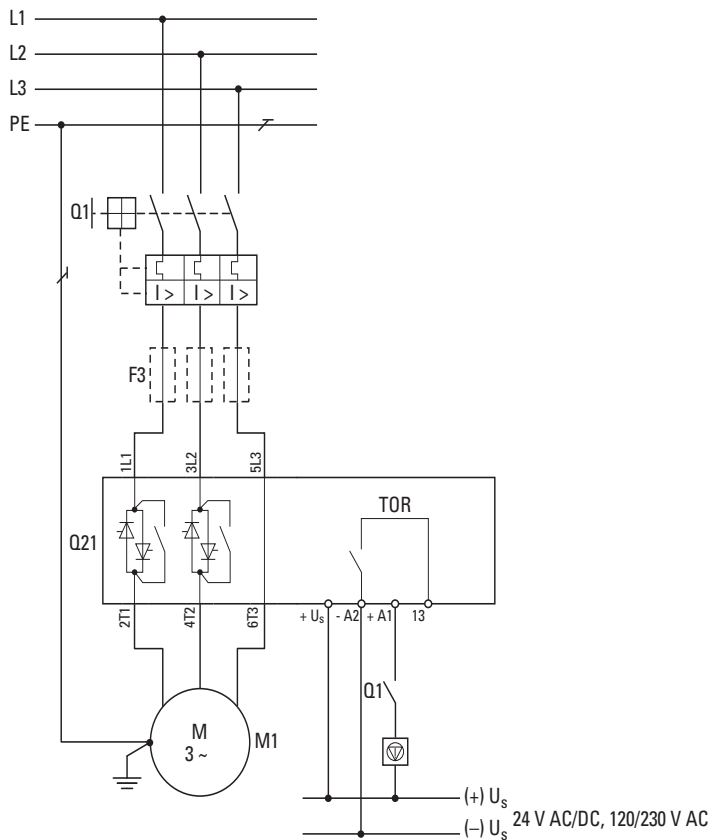

Standard connection

up to 32 A

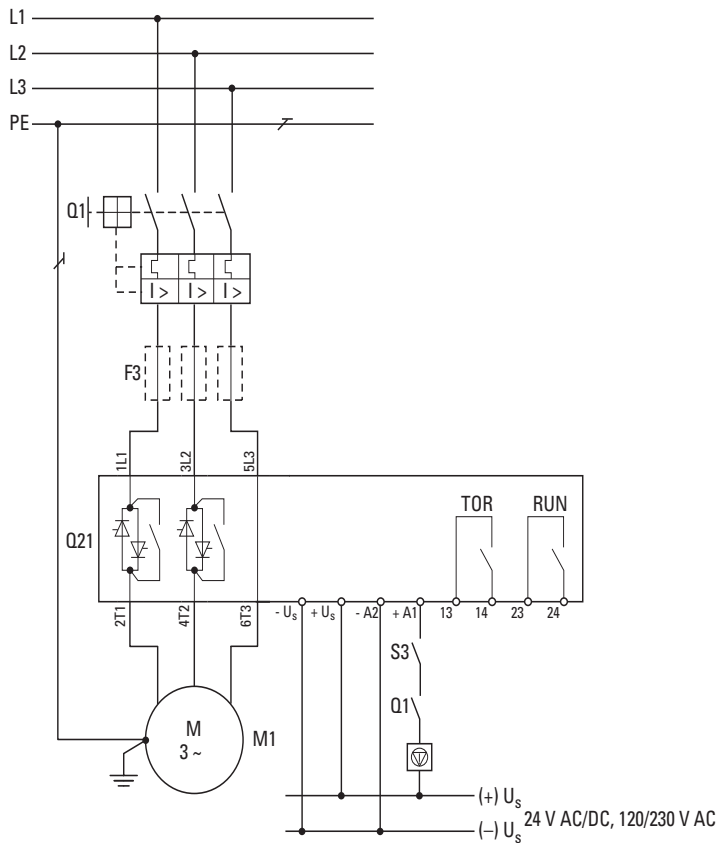

Standard connection

41 - 200 A

With Emergency switching off function according to IEC/EN 60 204-1 and VDE 0113 Part 1

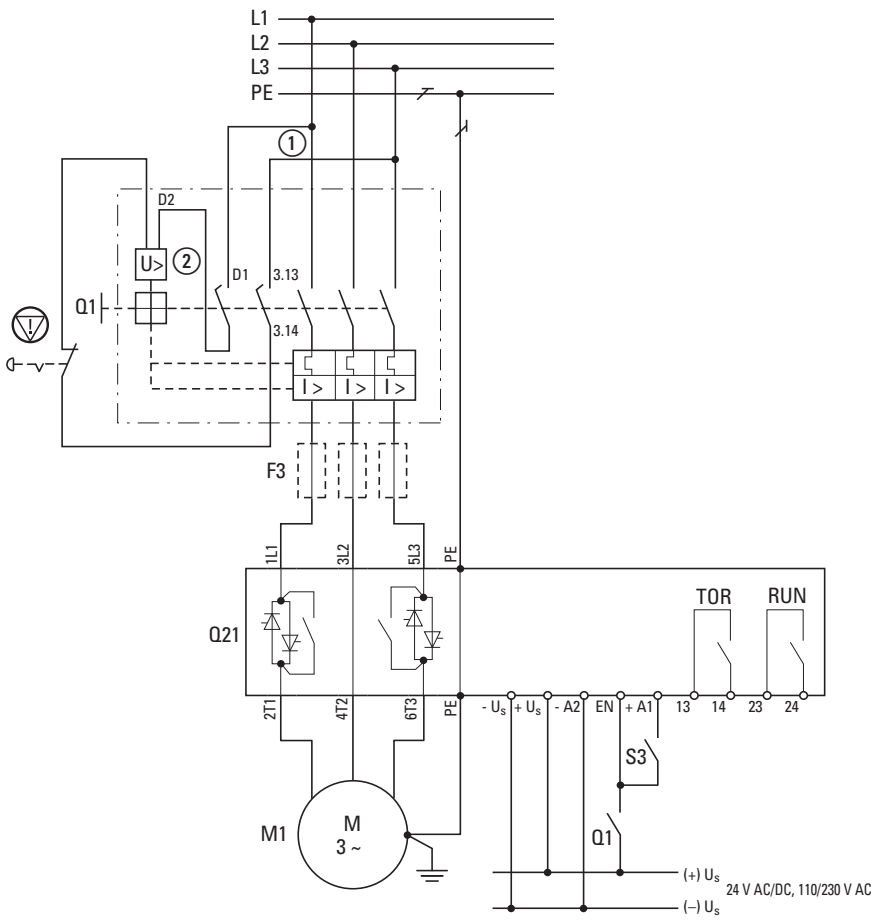

⊕ = EMERGENCY SWITCHING OFF

Q 1 = Cable and motor protection (NZM (NZM1, NZM2))

Q21 = Soft starter DS7

M1 = Motor

F3 = superfast semiconductor fuse, optional for type 2 coordination (in addition to Q1)

① Control circuit terminal

② Undervoltage release with early-make auxiliary contact

assigned Motor output at		Rated operational current <sup>1)</sup>		Part no. Soft starters (device to be selected)	Soft starter function  Cable protection <sup>2)</sup> Type "1" coordination
400 V P kW	480 V P HP	Motor $I_e$ A	Soft starters $I_e$ A		
				<b>Soft starters for three-phase mains connection, low operating frequency (5 s, 3 x <math>I_e</math>, 10 starts/h)</b>	
1.5	2	3.6	4	<b>DS7-34xSX004N0-x</b>	PKZM0-4 (+ CL-PKZ0)
3	3	6.6	7	<b>DS7-34xSX007N0-x</b>	PKZM0-10 (+ CL-PKZ0)
4	5	8.5	9	<b>DS7-34xSX009N0-x</b>	PKZM0-10 (+ CL-PKZ0)
5.5	7.5	11.3	12	<b>DS7-34xSX012N0-x</b>	PKZM0-12 (+ CL-PKZ0)
7.5	10	15.2	16	<b>DS7-34xSX016N0-x</b>	PKZM0-16 (+ CL-PKZ0)
11	15	21.7	24	<b>DS7-34xSX024N0-x</b>	PKZM0-25 (+ CL-PKZ0)
15	20	29.3	32	<b>DS7-34xSX032N0-x</b>	PKZM0-32 (+ CL-PKZ0)
22	25	41	41	<b>DS7-34xSX041N0-x</b>	NZMN1-M50 / PKZM4-50
30	30	55	55	<b>DS7-34xSX055N0-x</b>	NZMN1-M63 / PKZM4-58
37	40	68	70	<b>DS7-34xSX070N0-x</b>	NZMN1-M80
45	50	81	81	<b>DS7-34xSX081N0-x</b>	NZMN1-M100
55	60	99	100	<b>DS7-34xSX100N0-x</b>	NZMN1-M100
75	75	134	135	<b>DS7-34xSX135N0-x</b>	NZMN2-M160
90	100	160	160	<b>DS7-34xSX160N0-x</b>	NZMN2-M200
110	125	196	200	<b>DS7-34xSX200N0-x</b>	NZMN2-M200

**Notes**

<sup>1)</sup> Rated operational current based on the load cycle specified here.

<sup>2)</sup> Used to specify the circuit-breaker required for the specified load cycle. At different duty cycles (operating frequency, overcurrent, overcurrent time, duty factor), this value changes and must then be adapted accordingly.

<sup>3)</sup> An external overload relay is required if the main contacts should not be disconnected in the event of an overload and a controlled soft stop is desired instead.

<sup>4)</sup> A mains contactor is not required. Disconnection characteristics in accordance with VDE can only be ensured with the specified circuit-breaker.

<sup>5)</sup> The superfast semiconductor fuses protect the soft starter from short circuits on the motor side. This can not, however, prevent damage caused by voltage peaks, for example through lightning strike.

Soft starter function with soft stop in case of overload		Mains contactor	Semiconductor contactor (optional, in addition to the protective devices for type 1 coordination, required for type 2 coordination) <sup>2)</sup>	
Cable protection <sup>2)</sup> Type "1" coordination	overload relay <sup>3)</sup>	optional <sup>4)</sup>	Fuses Number x Part no.	Fuse holders Number x Part no.
PKM0-4 (+ CL-PKZ0)	ZB12-4	DILM7	3 x 170M1359	3 x 170H1007
PKM0-10 (+ CL-PKZ0)	ZB12-10	DILM9	3 x 170M1361	3 x 170H1007
PKM0-10 (+ CL-PKZ0)	ZB12-10	DILM9	3 x 170M1362	3 x 170H1007
PKM0-12 (+ CL-PKZ0)	ZB12-12	DILM12	3 x 170M1362	3 x 170H1007
PZM0-16 (+ CL-PKZ0)	ZB32-16	DILM17	3 x 170M1364	3 x 170H1007
PZM0-25 (+ CL-PKZ0)	ZB32-24	DILM25	3 x 170M1365	3 x 170H1007
PZM0-32 (+ CL-PKZ0)	ZB32-32	DILM32	3 x 170M1366	3 x 170H1007
NZMN1-M50 / PKZM4-50	ZB65-40+ZB65-XEZ	DILM50	3 x 170M1366	3 x 170H1007
NZMN1-M63 / PKZM4-58	ZB65-57+ZB65-XEZ	DILM65	3 x 170M2615	3 x 170H1007
NZMN1-M80	ZB150-70/KK	DILM80	3 x 170M4008	3 x 170H3004
NZMN1-M100	ZB150-100/KK	DILM95	3 x 170M4008	3 x 170H3004
NZMN1-M100	ZB150-100/KK	DILM115	3 x 170M4008	3 x 170H3004
NZMN2-M160	ZB150-150/KK	DILM150	3 x 170M4011	3 x 170H3004
NZMN2-M200	Z5-160/FF250	DILM185	3 x 170M5008	3 x 170H3004
NZMN2-M200	Z5-220/FF250	DILM225	3 x 170M6008	3 x 170H3004



## S801+/S811+ Soft Starters – a Powerful Presence in a Small Design

The unparalleled performance and features behind S801+ and S811+ soft starters build upon the proven capabilities of our soft starter series. With only five frame sizes and rated operational currents of 37 A to 1000 A for supply voltages of 200 V to 690 V, S801+ and S811+ units are some of the world's smallest compact soft starters.

These three-phase-controlled soft starters, which feature an internal bypass and comprehensive monitoring and protection mechanisms, provide a soft start and ensure that three-phase motors can remain in continuous operation safely and reliably even in applications with large load torques.

S801+ soft starters are designed with standard applications in mind and make a strong case with their ease of use, while S811+ devices feature a digital control and display unit that provides access to advanced functions for sophisticated applications. In addition, S811+ units can be used not only in a standard line (outside the delta) configuration, but also with an inside-the-delta configuration.



---

**System overview**

Soft starter S801+, S811+	118
---------------------------	-----

---

**Description**

Soft starter S801+, S811+	119
---------------------------	-----

---

**Key to type references, UL/CSA**

Soft starter S801+, S811+	120
---------------------------	-----

---

**Ordering**

Soft starter S801+, S811+	121
Accessories	123

---

**Engineering**

Connection examples S811+...N3S	125
---------------------------------	-----

System overview



S801+ / S811+ 1  
 → page 121

Superfast semiconductor fuses 2  
 → page 104

Terminal blocks 3  
 → page 123

EtherNet/IP - Modbus/TCP adapter 4  
 → page 123

External keypad 5  
 → page 123



## Description



The soft starters in series S801+ assure reliable operation even under tough and challenging ambient conditions. This series makes a compelling case as a result of its ease of use and is the perfect choice for standard applications such as pumps, fans, compressors, and conveyor belts.

S801+ soft starters have three-phase control and are equipped with internal bypass contacts for continuous operation. With their comprehensive protection and monitoring functions, S801+ soft starters ensure a soft startup, as well as safe and reliable continuous operation, for three-phase motors with rated operational currents of 11 A to 1,000 A when working with mains voltages of 200 V to 600 V. For example, when used in pump applications, they prevent water impact by using controlled deceleration (soft stop control) and torque monitoring, significantly reducing the mechanical loads exerted on pump systems in the process.

### Essential features S801+ / S811+

- Rated operational current: 37 - 1000 A
- Parameterizable overload settings: 31–100%
- Adjustable overload classes: class 5, 10, 20, 30
- Base setting: 15 s start ramp, 4 starts per hour, 300% starting current at 40 °C ambient temperature
- Allocated motor outputs for in-line connection:
  - 7.5 - 250 kW (3~ 230 V)
  - 18.5 - 560 kW (3~ 400 V)
- Ambient air temperature: -30 °C to +50 °C
- any required mounting position
- Degree of protection with compact design (IP20 optional)
- 5 compact designs
- Adjustable torque control
- Adjustable kick start
- Efficient use of power achieved with internal bypass contacts during continuous operation
- 24-V control voltage:
  - External supply required
  - 1 A continuous current
  - 10 A Inrush current (peak value for 150 ms)

### S801+ specific characteristics

- Microswitches and potentiometers make it easy to configure these soft starters

S811+ series soft starters provide all the features and characteristics of S801+ soft starters, plus expanded functionality and an operating unit (DIM = digital interface module).

With the S811+, motors can be connected using the standard line configuration or using the delta circuit (inside-the-delta configuration / six-wire connection). Using an inside-the-delta configuration will reduce the current flowing through the soft starter by approximately 42%. This way, a 58 A soft starter can be used to start and run a motor with a rated operational current of 100 A, for example.

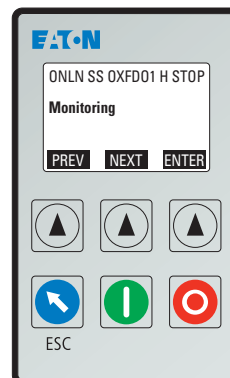

### Important operating unit characteristics (S811+)

- Language-neutral LCD display with backlight
- Easy to use and configure with function keys
- System parameter configuration
- Diagnostic and monitoring options
- Reading display (e.g., L1, L2, L3 phase currents)
- Error Display
- Offset placement (mounted on door), connection via plug-in patch cord with RJ11 plug
- Front IP54

### S811+ specific characteristics

- Mains voltage up to 690 V
- Allocated motor outputs for in-line connection:
  - 7.5 - 250 kW (3~ 230 V)
  - 18.5 - 560 kW (3~ 400 V)
  - 160 - 710 kW (3~ 690 V)
- Special pump control algorithm with prolonged soft stop ramp
- In-delta connection, see "Engineering, connecting examples"
- RS485 Modbus Connection
- EtherNet-IP/Modbus-TCP with option C441 (communication adapter).

**Key to type references**

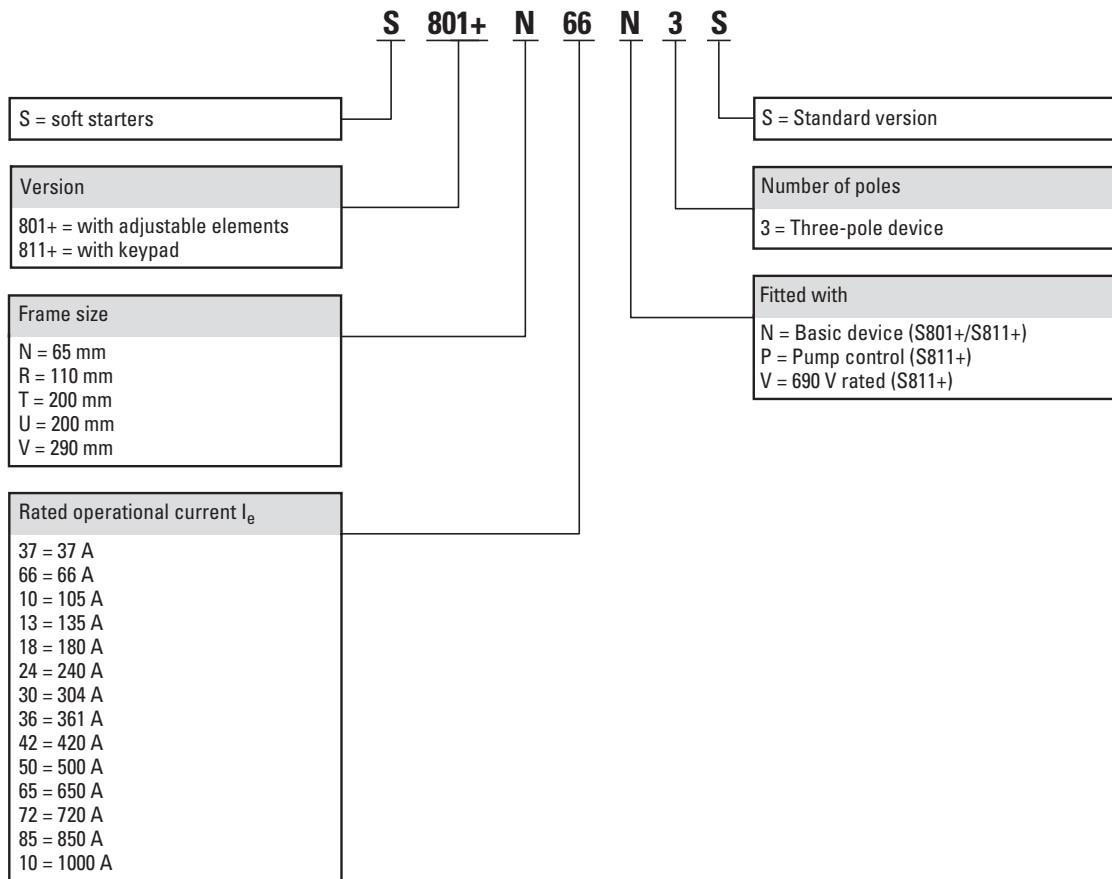

**UL/CSA**

Information relevant for export to North America





	<b>S801+N..., S801+R..., S801+T... (600 V)</b> <b>S811+N..., S811+R..., S811+T... (600 V)</b>
Product Standards	IEC/EN 60947-4-2; UL 508; CSA C22.2 No. 14; CE marking
UL File No.	E202571
UL CCN	NMFT
CSA File No.	LR 353
CSA Class No.	3211-06, 2411-01
NA Certification	UL Listed, CSA Certified
Conditions of Acceptability	None
Suitable for	Branch Circuits, not as BCPD
Max. Voltage Rating	600 Vac
Degree of Protection	IP20 with kit

	<b>S801+U..., S801+V... bis 850 A (600 V)</b> <b>S811+U..., S811+V... bis 850 A (600 V)</b>
Product Standards	IEC/EN 60947-4-2; UL 508; CSA C22.2 No. 14; CE marking
UL File No.	E202571
UL CCN	NMFT
CSA File No.	LR 353
CSA Class No.	3211-06
NA Certification	UL Listed, CSA Certified
Conditions of Acceptability	None
Suitable for	Branch Circuits, not as BCPD
Max. Voltage Rating	600 Vac
Degree of Protection	IP20 with kit

	<b>S801+V..., 1000 A (600 V)</b> <b>S811+V..., 1000 A (600 V)</b>
Product Standards	IEC/EN 60947-4-2; UL 508; CSA C22.2 No. 14; CE marking
UL File No.	E202571
UL CCN	NMFT2
CSA File No.	LR 353
CSA Class No.	3211-06
NA Certification	UL Recognized, CSA Certified
Conditions of Acceptability	98-115 CFM fan and 4" x 4" vent req'd
Suitable for	Branch Circuits, not as BCPD
Max. Voltage Rating	600 Vac
Degree of Protection	IP20 with kit

	<b>S811+...V3S (690 V)</b>
Product Standards	IEC/EN 60947-4-2; UL 508; CE marking
UL File No.	E202571
UL CCN	NMFT
NA Certification	UL Listed
Conditions of Acceptability	None
Suitable for	Branch Circuits, not as BCPD
Max. Voltage Rating	690 Vac
Degree of Protection	IP20 with kit

Ordering

Frame size	Rated operational current AC-53 $I_e$ A	Assigned motor rating				Part no.	Article no.	Price see price list	Std. pack
		at 230 V, 50 Hz kW	at 230 V, 60 Hz HP	at 400 V, 50 Hz kW	at 460 V, 60 Hz HP				
<b>Soft starters</b>									
Supply voltage $U_s$ : 24 V DC Control voltage $U_c$ : 24 V DC With internal bypass contacts Terminal blocks for the terminals are required for frame sizes T, U, and V -> Accessories									
Soft starters for three-phase loads Mains supply voltage (50/60 Hz) $U_{LN}$ : 200 - 600 V AC In-line configuration									
N	37	7.5	10	18.5	25	S801+N37N3S	169852		1 off  
	66	18.5	20	30	50	S801+N66N3S	169853		
R	105	30	40	55	75	S801+R10N3S	169854		
	135	37	50	75	100	S801+R13N3S	169855		
T	180	55	60	90	150	S801+T18N3S	169856		
	240	75	75	132	200	S801+T24N3S	169857		
	304	90	100	160	250	S801+T30N3S	169858		
U	361	110	125	200	300	S801+U36N3S	169859		
	420	132	150	200	350	S801+U42N3S	169860		
V	361	110	125	200	300	S801+V36N3S	169863		
	420	132	150	200	350	S801+V42N3S	169864		
	500	160	200	250	400	S801+V50N3S	169865		
	650	200	250	315	500	S801+V65N3S	169866		
	720	250	-	400	600	S801+V72N3S	169867		
	850	-	-	450	600	S801+V85N3S	169868		
	1000	-	-	560	750	S801+V10N3S	169862		
Soft starter for three-phase loads, with control unit Mains supply voltage (50/60 Hz) $U_{LN}$ : 200 - 600 V AC In-line configuration/In-delta configuration									
N	37	7.5	10	18.5	25	S811+N37N3S	168976		1 off  
	66	18.5	20	30	50	S811+N66N3S	168978		
R	105	30	40	55	75	S811+R10N3S	168980		
	135	37	50	75	100	S811+R13N3S	168982		
T	180	55	60	90	150	S811+T18N3S	168984		
	240	75	75	132	200	S811+T24N3S	168987		
	304	90	100	160	250	S811+T30N3S	168990		
U	361	110	125	200	300	S811+U36N3S	169869		
	420	132	150	200	350	S811+U42N3S	169870		
V	361	110	125	200	300	S811+V36N3S	168993		
	420	132	150	200	350	S811+V42N3S	168996		
	500	160	200	250	400	S811+V50N3S	168999		
	650	200	250	315	500	S811+V65N3S	169002		
	720	250	-	400	600	S811+V72N3S	169005		
	850	-	-	450	600	S811+V85N3S	169008		
	1000	-	-	560	750	S811+V10N3S	169011		

Notes   Information relevant for export to North America → Page 120





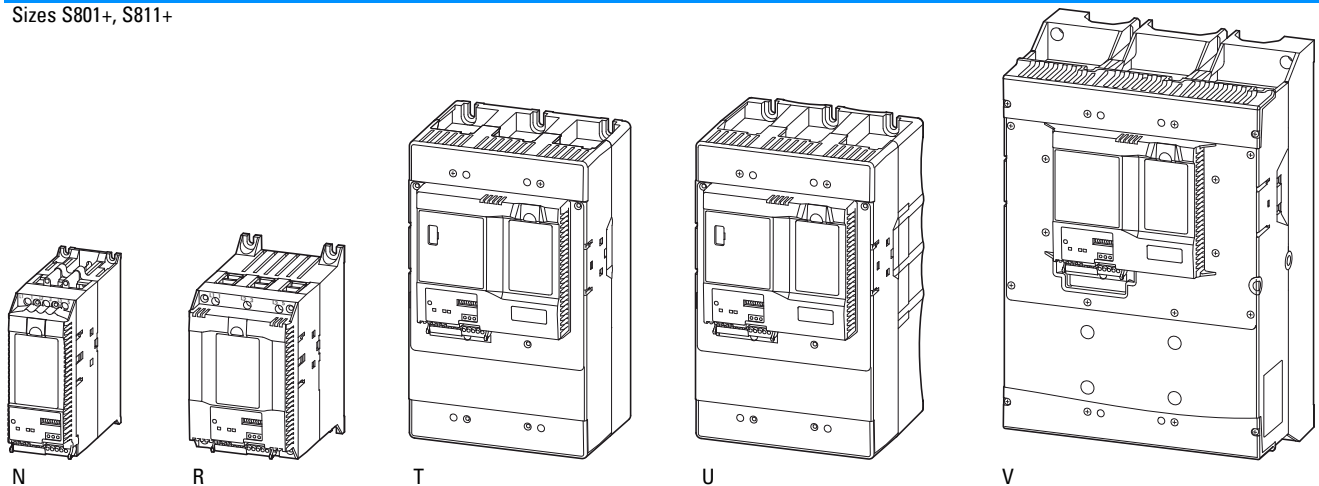

S801+/S811+

Frame size	Rated operational current AC-53 $I_e$ A	Assigned motor rating					Part no.	Article no.	Price see price list	Std. pack
		at 230 V, 50 Hz kW	at 230 V, 60 Hz HP	at 400 V, 50 Hz kW	at 460 V, 60 Hz HP	at 690 V, 50 Hz kW				
<b>Soft starters</b>										
Supply voltage $U_s$ : 24 V DC Control voltage $U_c$ : 24 V DC With internal bypass contacts Terminal blocks for the terminals are required for frame sizes T, U, and V -> Accessories										
Soft starter for three-phase loads, with control unit and pump algorithm Mains supply voltage (50/60 Hz) $U_{LN}$ : 200 - 600 V AC In-line configuration/In-delta configuration										
N	37	7.5	10	18.5	25	-	S811+N37P3S	168977		1 off 
	66	18.5	20	30	50	-	S811+N66P3S	168979		
R	105	30	40	55	75	-	S811+R10P3S	168981		
	135	37	50	75	100	-	S811+R13P3S	168983		
T	180	55	60	90	150	-	S811+T18P3S	168985		
	240	75	75	132	200	-	S811+T24P3S	168988		
	304	90	100	160	250	-	S811+T30P3S	168991		
U	361	110	125	200	300	-	S811+U36P3S	169872		
	420	132	150	200	350	-	S811+U42P3S	169873		
V	361	110	125	200	300	-	S811+V36P3S	168994		
	420	132	150	200	350	-	S811+V42P3S	168997		
	500	160	200	250	400	-	S811+V50P3S	169000		
	650	200	250	315	500	-	S811+V65P3S	169003		
	720	250	-	400	600	-	S811+V72P3S	169006		
	850	-	-	450	600	-	S811+V85P3S	169009		
	1000	-	-	560	750	-	S811+V10P3S	169012		
Soft starter for three-phase loads, with control unit and pump algorithm, for 690-V grids Mains supply voltage (50/60 Hz) $U_{LN}$ : 200 - 690 V AC In-line configuration										
T	180	55	60	90	150	160	S811+T18V3S	168986		1 off 
	240	75	75	132	200	200	S811+T24V3S	168989		
	304	90	100	160	250	250	S811+T30V3S	168992		
V	361	110	150	200	300	315	S811+V36V3S	168995		
	420	132	150	200	350	400	S811+V42V3S	168998		
	500	160	200	250	400	500	S811+V50V3S	169001		
	650	200	250	315	500	630	S811+V65V3S	169004		
	720	250	-	400	600	630	S811+V72V3S	169007		
	850	-	-	450	600	710	S811+V85V3S	169010		

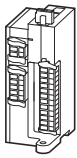

Sizes S801+, S811+

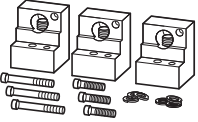

Information relevant for export to North America → Page 120

Description	For use with	Part no. Article no.	Price see price list	Std. pack	Information relevant for export to North America 
<b>Control unit</b>					
With adjusting elements (potentiometer, microswitch)	S801+	<b>EMA71</b> 144346		1 off 	Product Standards IEC/EN 60947-4-2; UL 508; CSA C22.2 No. 14; CE marking UL File No. E202571 CSA File No. LR 353 Conditions of Acceptability UL unlisted component, CSA Investigated Component
With illuminated LCD display With control buttons and function keys Front IP54 RJ11 plug, 6-pin	S811+	<b>EMA91</b> 144570			
<b>Cover</b>					
Protection for installation space in S811+ if the control unit is set up externally.	S801+	<b>EMA68</b> 144556		1 off	
<b>Mounting frame</b>					
For mounting the EMA91 control unit externally with surface mounting (e.g., installation in control panel door).					
with connection cable RJ11, 6 pole	1 m	EMA91	<b>EMA69A</b> 144557	1 off 	Product Standards IEC/EN 60947-4-2; UL 508; CSA C22.2 No. 14; CE marking UL File No. E202571 UL Category Control No. NMFT2 CSA File No. LR 353 CSA Class No. 3211-06 North America Certification UL listed, CSA certified
	1.5 m	EMA91	<b>EMA69B</b> 144558		
	2 m	EMA91	<b>EMA69C</b> 144559		
	3 m	EMA91	<b>EMA69D</b> 144560		
<b>EtherNet/IP - Modbus/TCP adapter</b>					
	S811+	<b>C441V</b> 172306		1 off 	Product Standards IEC/EN 60947-4-1; UL 508; CSA C22.2 No. 14; CE marking UL File No. E1230 UL Category Control No. NKCR CSA File No. LR 353 CSA Class No. 3211-03 Max. Voltage Rating 240 Vac (auxiliary contacts)
<b>Control terminal strip</b>					
Spare part	S801+, S811+	<b>EMA75</b> 144561		1 off	
<b>Terminal blocks</b>					
Tools with dimensions in inches required 1 set required for each connection side.					
					
Terminal capacities					
2 x 4-1/0MCM, 2 x 25-50 mm <sup>2</sup>	S801+, S811+, frame sizes T and U	<b>EML22</b> 127661		1 off 	Product Standards UL 1059 UL File No. E60693 UL Category Control No. NMFT CSA File No. LR 353 CSA Class No. 6223-02 North America Certification UL listed, CSA certified Conditions of Acceptability 10A min, Use group C or D, 30 to 12 AWG solid/stranded Max. Voltage Rating 300 V <sub>ac</sub>
4/0-500 MCM, 120-240 mm <sup>2</sup> S801+, S811+, frame sizes T and U		<b>EML23</b> 127662			Product Standards UL508, CSA C22.2 No. 65 UL File No. E202571 UL Category Control No. NMFT CSA File No. LR 353 CSA Class No. 6223-02 North America Certification UL listed, CSA certified
2 x 4/0-500 MCM, 2 x 120-240 mm <sup>2</sup> S801+, S811+, frame sizes T and U		<b>EML24</b> 127663			
1 x 2/0-300 MCM, 1 x 70-150 mm <sup>2</sup> S801+, S811+, frame sizes T and U		<b>EML25</b> 127664			
2 x 2/0-300 MCM, 2 x 70-150 mm <sup>2</sup> S801+, S811+, frame sizes T and U	<b>EML26</b> 127665				
2 x 4/0-500 MCM, 2 x 120-240 mm <sup>2</sup> S801+, S811+, frame size V	S801+, S811+, frame sizes T and U	<b>EML28</b> 127666			
4 x 4/0-500 MCM, 4 x 120-240 mm <sup>2</sup> S801+, S811+, frame size V		<b>EML30</b> 127667			
6 x 4/0-500 MCM, 6 x 120-240 mm <sup>2</sup> S801+, S811+, frame size V		<b>EML32</b> 127668			
4 x 2/0-300 MCM, 4 x 70-150 mm <sup>2</sup> S801+, S811+, frame size V		<b>EML33</b> 127669			

S801+/S811+

Description	For use with	Part no. Article no.	Price see price list	Std. pack	Information relevant for export to North America 
<b>terminal shroud</b>					
For increasing the degree of protection to IP20 1 set required for each connection side.	S801+, S811+, frame size N	<b>SS-IP20-N</b> 171990		1 off	
	S801+, S811+, frame size R	<b>SS-IP20-R</b> 171991			
	S801+, S811+, frame sizes T und U	<b>SS-IP20-TU</b> 171992			
	S801+, S811+, frame size V	<b>SS-IP20-V</b> 158650			
<b>TVSS</b>					
SMD metal-oxide varistors (MOV) with connection cables for the grid and motor connection sides	S801+, S811+, up to 600 V	<b>EMS39</b> 127671		1 off 	Product Standards UL 508; CSA C22.2 No. 14 UL File No. E202571 CSA File No. LR 353 Conditions of Acceptability UL and CSA Investigated Component Max. Voltage Rating 1000 V <sub>ac</sub> 3 ph
	S811+, up to 690 V	<b>EMS41</b> 127672		1 off	
<b>Power supplies PSG</b>					
Rated output voltage 24 V DC (± 2%) Rated output current 10 A	Nominal input voltage 100 - 240 V AC 125 - 250 V DC_x 1-phase	<b>PSG240E24RM</b> 172893			
	Nominal input voltage 3 x 400 - 500 V AC 3-phase	<b>PSG240F24RM</b> 172884			

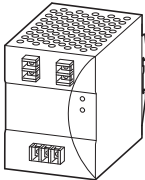

## Engineering

### Connection examples for S811+...N3S

Standard connection (in-line connection)

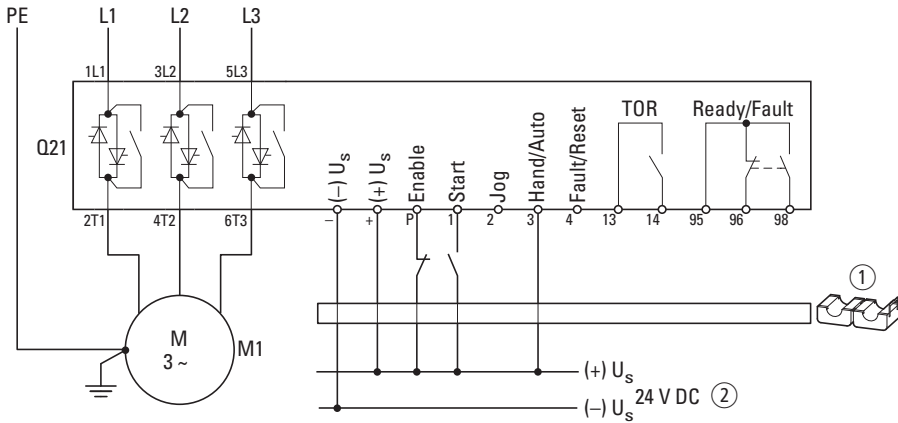

Delta circuit (inside-the-delta circuit)

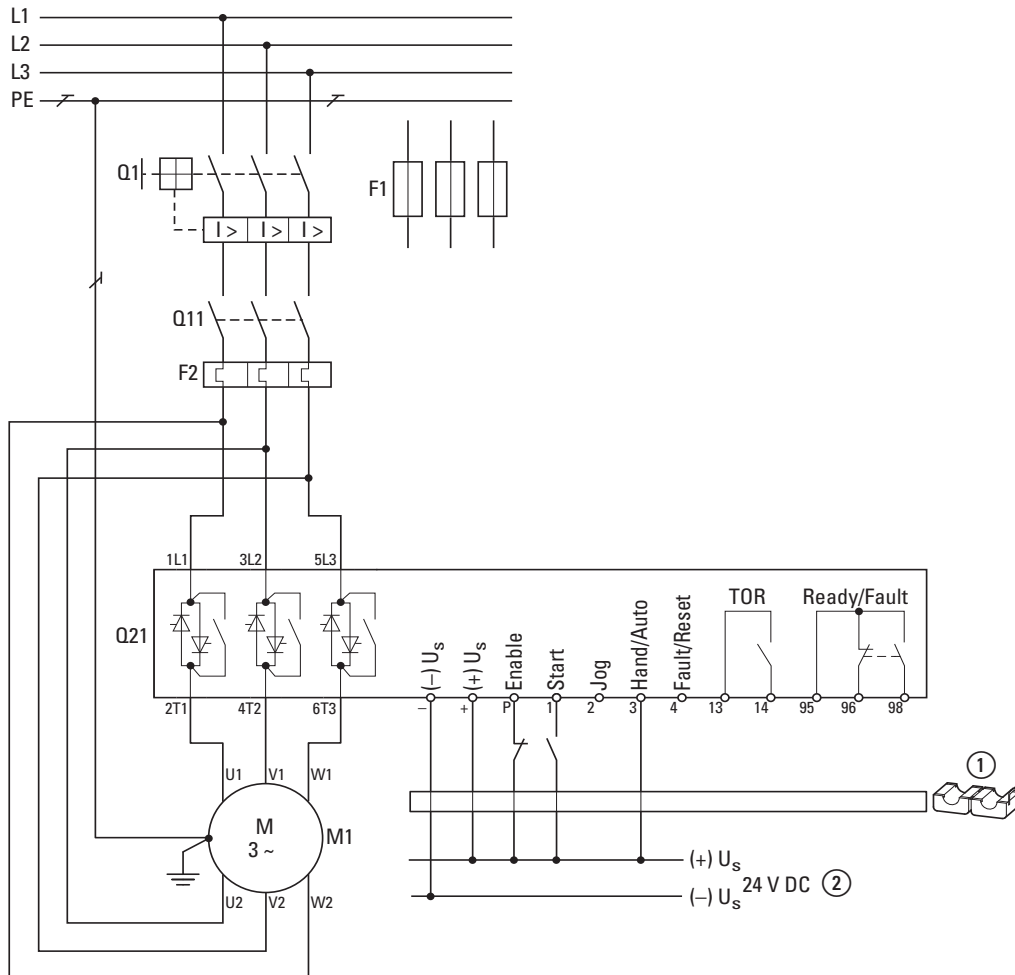

① Snap-on ferrite core, included as standard

② External control voltage (24 VDC) required, I<sub>s</sub> 1 A, I<sub>Peak</sub> = 10 A for 150 ms when bypass contacts are switched  
Short-circuit and cable protection: Q1 circuit-breakers or F1 fuses.

Motor	IEC	NEMA
	U1-V1-W1	T1-T2-T3
	U2-V2-W2	T4-T5-T6



# Distributed Drive System Rapid Link 4.0

Standardized installation procedures, the ability to directly and locally configure parameters with a plug and play configuration, and networked communications – these are the needs of material handling system applications today when it comes to state-of-the-art drive engineering and the systems it produces.

Eaton delivers a modern answer with the Rapid Link 4.0 distributed drive system. With its flexible power spectrum, its simple handling and its intelligent programming options, this new motor starter and variable frequency drives generation is the first choice for all kinds of conveying engineering applications.

## **RAMO electronic motor starters**

Electronic DOL and reversing starters with a lifespan of more than 10 million operations, degree of protection IP65

Rated operational current, adjustable between 0.3 – 6.6 A when using a three-phase mains connection with 400 V – 480 V, for rated motor outputs of up to 3.0 kW (400 V) / 3 HP (460 V)

**RAMO-D...**: DOL starter

**RAMO-W...**: reversing starter

## **RASP speed controllers**

Frequency-controlled motor starters with Volts-per-Hertz control (V/Hz control) and slip compensation or vector control, as well as an integrated radio interference suppression filter (EMC); IP65 degree of protection.



**RASP-2...**: Rated operational current of 0.48 – 2.4 A with three-phase mains connection of 400 V – 480 V, allocated motor output of up to 0.75 kW (400 V) / 1 HP (460 V)

**RASP-3...**: Rated operational current of 0.66 – 3.3 A with three-phase mains connection of 400 V – 480 V, allocated motor output of up to 1.1 kW (400 V) / 1.5 HP (460 V)

**RASP-4...**: Rated operational current of 0.86 – 4.3 A with three-phase mains connection of 400 V – 480 V, allocated motor output of up to 1.5 kW (400 V) / 2 HP (460 V)

**RASP-5...**: Rated operational current of 1.12 – 5.6 A with three-phase mains connection of 400 V – 480 V, allocated motor output of up to 2.2 kW (400 V) / 3 HP (460 V)



	<a href="#">System overview</a>	128
	<b>Description</b>	
	<a href="#">Application and function, features</a>	130
	<a href="#">Key to type references</a>	131
	<b>Ordering</b>	
	<a href="#">Motor starter RAMO</a>	132
	<a href="#">RASP speed controllers</a>	133
	<a href="#">Accessories</a>	134
	<b>Engineering</b>	
	<a href="#">General information on Engineering</a>	138
	<a href="#">Block diagram DOL starter RAMO-D</a>	140
	<a href="#">Block diagram RAMO-W reversing starter</a>	141
	<a href="#">Block diagram RASP with 230V brake</a>	142
	<a href="#">Block diagram RASP with 400V brake</a>	143

System overview

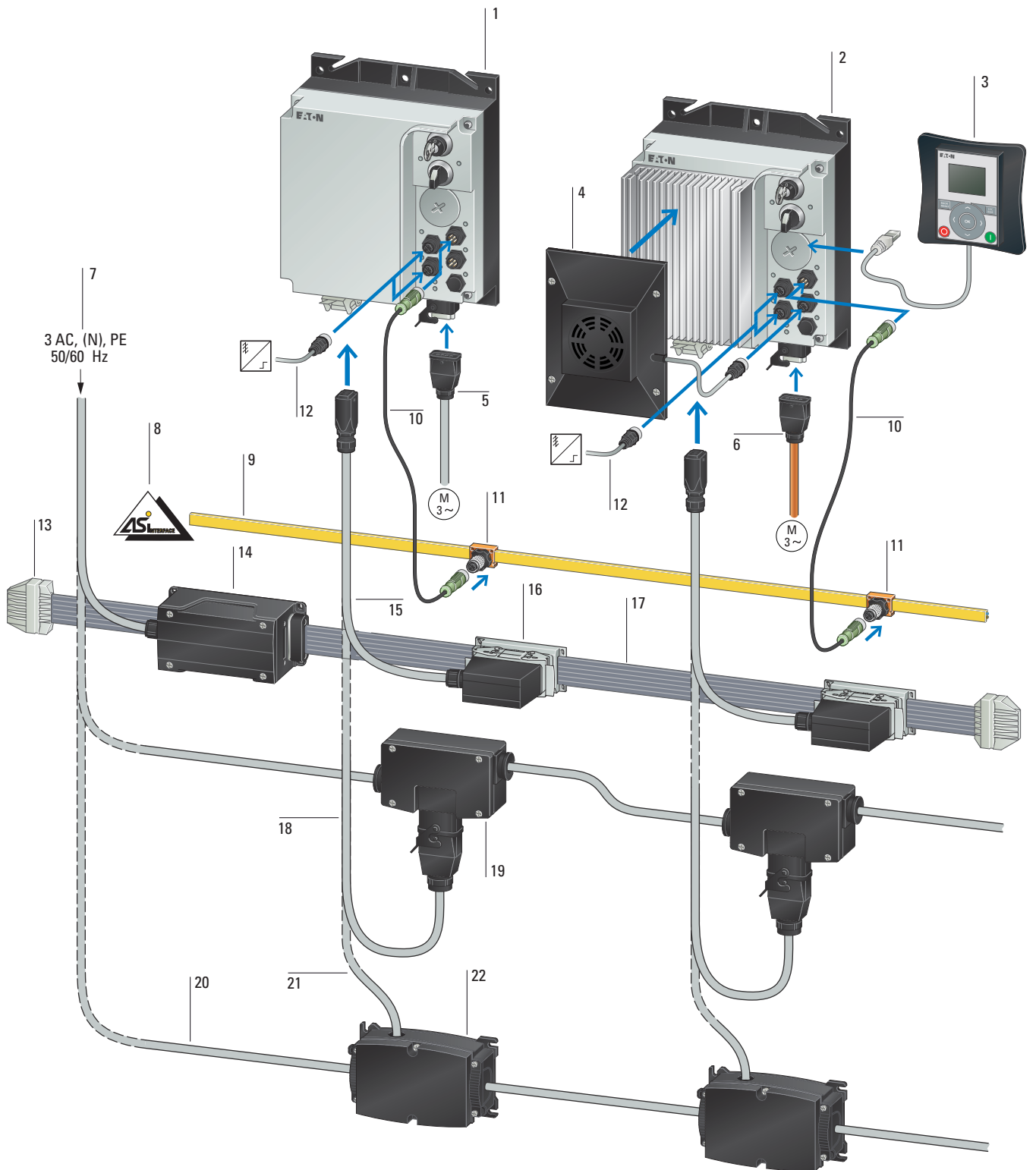

## Function modules

<b>Motor starter (Motor Control Unit)</b>	1
Three-phase electronic DOL starter or reversing starter	
→ page 132	
<b>Speed controller RASP (Speed Control Unit)</b>	2
Three phase frequency-controlled motor starter (fixed speeds, two rotational directions, adjustable acceleration and deceleration ramps)	
→ page 133	
<b>Operating unit</b>	3
for parameter setting	
→ page 134	
<b>Fans</b>	4
for operation at high temperatures without derating	
→ page 134	

## Motor feeder

<b>Unscreened motor cable</b>	5
→ page 134	
<b>Screened motor supply cable (EMC)</b>	6
→ page 134	

## Power and data bus

<b>Energy supply (3 AC 400 V) via circuit-breaker for overload and short-circuit protection</b>	7
for protection against short-circuit and overload	
<b>AS-Interface® supply</b>	8
<b>AS-Interface® flat cable</b>	9
<b>AS-Interface® connection cable</b>	10
→ page 137	
<b>AS-Interface® junction</b>	11
→ page 137	
<b>Sensor connection</b>	12
→ page 137	
<b>End-piece for flat cable</b>	13
→ page 136	
<b>Distribution module</b>	14
for 400-V-AC incoming unit of the flat cable	
→ page 135	
<b>Power connection cable</b>	15
to flexible busbar junction	
→ page 134	
<b>flexible busbar junction</b>	16
→ page 135	
<b>Ribbon cable for 400 V AC</b>	17
→ page 134	
<b>Power connection cable</b>	18
to round cable junction	
→ page 136	
<b>Round cable junction</b>	19
→ page 136	
<b>Round cable for 400 V AC</b>	20
<b>Power connection cable</b>	21
to round cable junction	
→ page 136	
<b>Round cable junction</b>	22
→ page 136	

Rapid Link 4.0 is a modern, efficient drive and PLC. It is the competent further development of the Rapid Link 2.1/3.0 device series, suitable for simple and complex tasks in all aspects of material handling. For example in airports, industrial production and logistics centers. The Rapid Link system consists of the RAMO electronic motor starters and the RASP frequency controlled motor starters.

The RAMO and RASP motor starters are designed with IP65 protection and can be installed in direct proximity to the drive. Their versions and mounting depend on the required specifications and the local conditions. The RAMO and RASP are connected with standard plug connectors to the energy and databus systems predominantly used in material handling systems (AS-Interface). Connection can be implemented without interrupting the required location. This simplifies installation and reduces the wiring requirement.



### Overview of features

#### RAMO 4.0 electronic motor starters

##### Application and function

The RAMO motor starters enable the electronic DOL or reversing starting of three-phase motors in automatic or manual mode. The electronic overload protection for motor ratings from 90 W to 3 kW at 400 V (50/60 Hz) is configured with DIP switches. Full motor protection is ensured when used in connection with temperature sensors.

The operating mode is set via the AUTO - OFF/RESET – MANUAL key switch and can be combined with the 'Quick stop' and 'Interlocked manual operation' via the two sensor inputs (M12 sockets). Operating states are diagnosed and error messages (Reset) acknowledged on the device or via the AS-Interface. RAMO is available in different versions:

- with actuator output (24 V DC) for a direct actuation of external switching devices, e.g. solenoid valves.
- with electronic actuation for mechanical motor brakes.
- with lockable repair switch for diagnostic and maintenance work, making it possible to safely de-energize the device locally.

##### Essential features

- Standard size in square enclosure. The bottom section with the two power terminals (power plug, motor feeder socket) and the repair and maintenance switch can be turned 90° clockwise and counterclockwise.
- Long lifespan up to 10 million switching operations and up to 3,000 switch cycles per hour at 2.2 kW.
- Rated operational current 6.6 A.
- Operating and ambient temperature from -10 to +55 °C, without derating.
- Monitoring of thermistor and motor cable.
- Maximum motor cable length: 10 m.

#### Frequency controlled motor starter RASP 4.0

##### Application and function

The RASP motor starter enables the infinitely variable speed control of three-phase motors in the range from zero to 320 Hz. The standard size for 400 V (50/60 Hz) is assigned four motor ratings: 0.75 kW, 1.1 kW, 1.5 kW and 2.2 kW. Full motor protection is ensured by the adjustable current limitation (I<sup>2</sup>t controller).

The operating mode is set via the AUTO - OFF/RESET – MANUAL key switch and can be combined with the 'Quick stop' and 'Interlocked manual operation' via the two sensor inputs (M12 sockets). Settable fixed frequencies and cyclical program sequences extend the application range and relieve the load on the higher-level head-end controller (PLC). Operating states are diagnosed and error messages (Reset) acknowledged on the device or via the AS-Interface. A hand-held programmer and a PC interface are available for the parameterization of the variable frequency drive module.

RASP is available in different versions:

- with integrated brake chopper with braking resistance for dynamic braking.
- with electronic actuation for mechanical motor brakes.
- with lockable repair switch for diagnostic and maintenance work, making it possible to safely de-energize the device locally.

##### Essential features

- Standard size in square enclosure. The bottom section with the two power terminals (power plug, motor feeder socket) and the repair and maintenance switch can be turned 90° clockwise and counterclockwise.
- Monitoring of thermistor and motor cable.
- Operating and ambient temperatures from 0 to +40 °C without derating, with optional fan in the performance range up to 1.5 kW max. +55 °C.
- Rated operational current: 2.4 A, 3.3 A, 4.3 A, 5.6 A
- EMC class C3 in 2nd environment
- Maximum motor cable length: 5 m.

Electronic motor starters RAMO

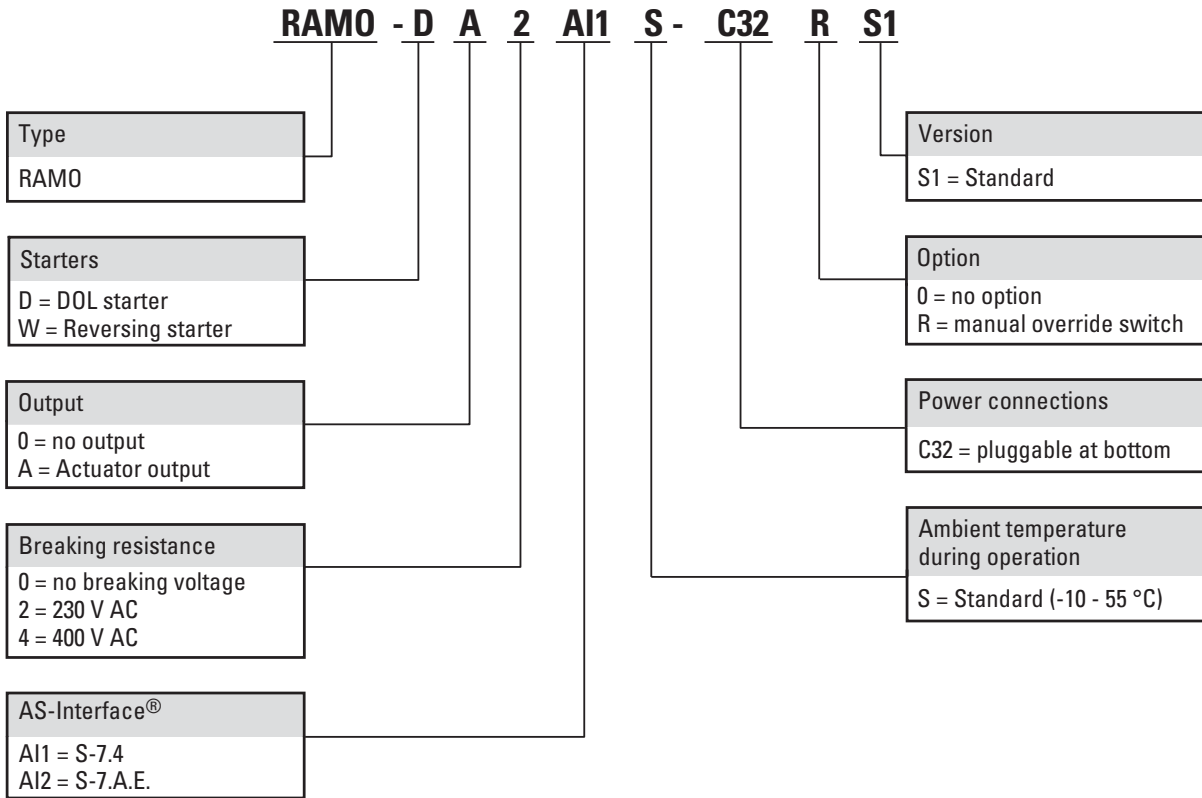

Frequency controlled motor starter RASP

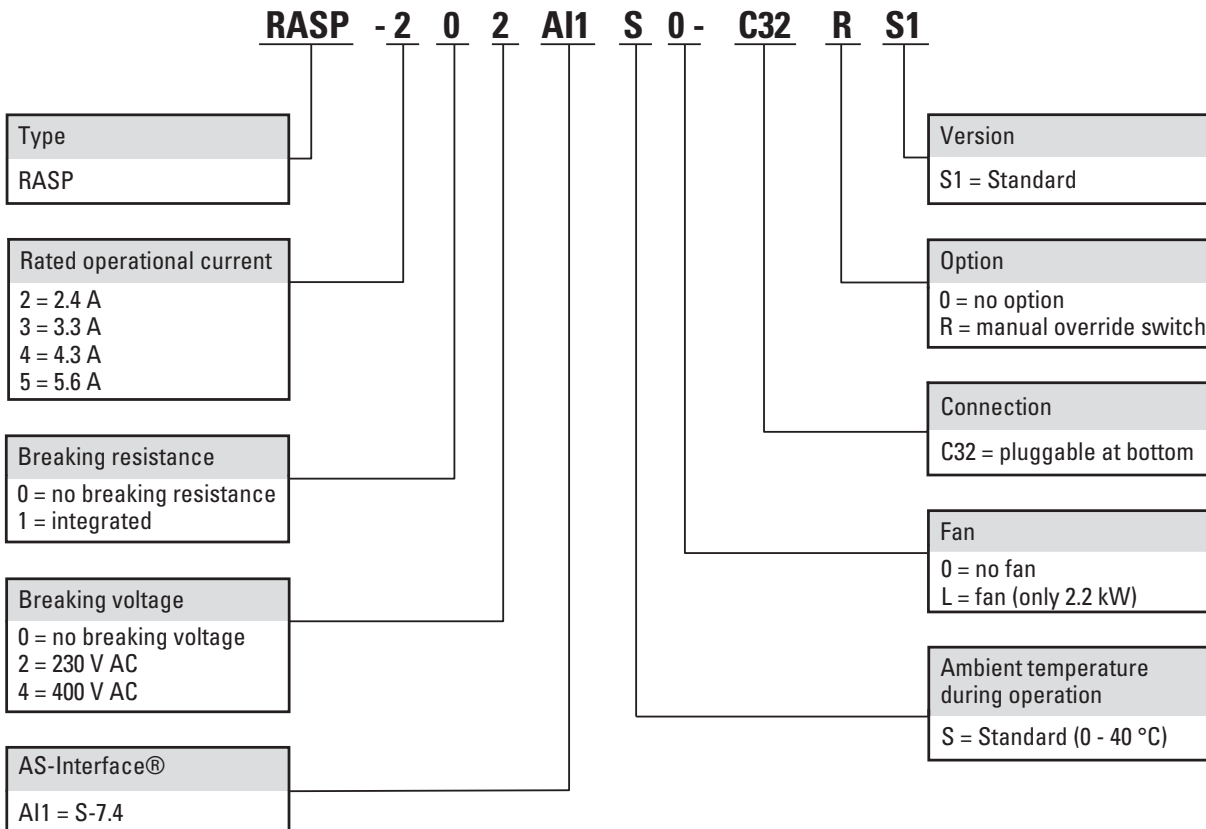

## Ordering

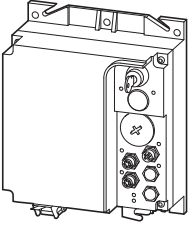
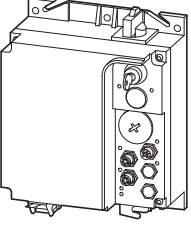
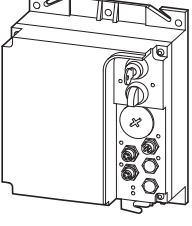
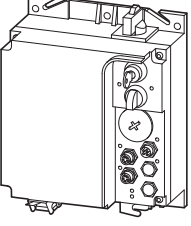
	Rated operational current <sup>1)</sup> I <sub>e</sub> A	assigned motor rating P <sup>2),3)</sup> P kW      P HP		Control voltage external brake (50/60 Hz) <sup>4)</sup> V AC	Actuator output <sup>5)</sup> Number	AS-Interface profile cable S-7.4 for 31 modules S-7.A.E. for 62 modules	Part no. Article no.	Price see price list	Std. pack
<b>Motor starter RAMO</b>									
Rated operational voltage 400 V AC, 3-phase Mains voltage (50/60Hz) U <sub>LN</sub> 380 (-10%) - 480 (+10%) V									
<b>DOL starters</b>									
	6.6	0,09 - 3	0,125 - 3	-	-	✓ -	<b>RAMO-D00AI1S-C320S1</b> 150150		1 off
				230	-	✓ -	<b>RAMO-D02AI1S-C320S1</b> 150152		
				230	-	- ✓	<b>RAMO-D02AI2S-C320S1</b> 171776		
				230	1	✓ -	<b>RAMO-DA2AI1S-C320S1</b> 164321		
				400	-	✓ -	<b>RAMO-D04AI1S-C320S1</b> 169799		
				400	-	- ✓	<b>RAMO-D04AI2S-C320S1</b> 171778		
				400	1	✓ -	<b>RAMO-DA4AI1S-C320S1</b> 169800		
<b>with manual override switch</b>									
	6.6	0,09 - 3	0,125 - 3	-	-	✓ -	<b>RAMO-D00AI1S-C32RS1</b> 150158		1 off
				230	-	✓ -	<b>RAMO-D02AI1S-C32RS1</b> 150160		
				230	-	- ✓	<b>RAMO-D02AI2S-C32RS1</b> 171782		
				400	-	✓ -	<b>RAMO-D04AI1S-C32RS1</b> 169801		
				400	-	- ✓	<b>RAMO-D04AI2S-C32RS1</b> 171784		
<b>Reversing starter with selector switch REV - OFF - FWD</b>									
	6.6	0,09 - 3	0,125 - 3	-	-	✓ -	<b>RAMO-W00AI1S-C320S1</b> 150151		1 off
				230	-	✓ -	<b>RAMO-W02AI1S-C320S1</b> 150153		
				230	-	- ✓	<b>RAMO-W02AI2S-C320S1</b> 171777		
				230	1	✓ -	<b>RAMO-WA2AI1S-C320S1</b> 164322		
				230	1	- ✓	<b>RAMO-WA2AI2S-C320S1</b> 174473		
				400	-	✓ -	<b>RAMO-W04AI1S-C320S1</b> 169802		
				400	-	- ✓	<b>RAMO-W04AI2S-C320S1</b> 171779		
				400	1	✓ -	<b>RAMO-WA4AI1S-C320S1</b> 169803		
<b>with manual override switch</b>									
	6.6	0,09 - 3	0,125 - 3	-	-	✓ -	<b>RAMO-W00AI1S-C32RS1</b> 150159		1 off
				230	-	✓ -	<b>RAMO-W02AI1S-C32RS1</b> 150161		
				230	-	- ✓	<b>RAMO-W02AI2S-C32RS1</b> 171783		
				400	-	✓ -	<b>RAMO-W04AI1S-C32RS1</b> 169804		
				400	-	- ✓	<b>RAMO-W04AI2S-C32RS1</b> 171785		

## Instructions

<sup>1)</sup> 0,3 - 6.6 adjustable

<sup>2)</sup> for normal internally and externally ventilated 4 pole, three-phase asynchronous motors with 1500 rpm<sup>-1</sup> at 50 Hz or 1800 min<sup>-1</sup> at 60 Hz

<sup>3)</sup> at 400 V, 50 Hz  
at 440 - 480 V, 60 Hz

<sup>4)</sup> for actuation of motors with mechanical brake

<sup>5)</sup> Operation with external 24V DC supply

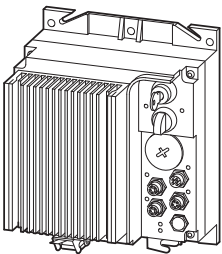
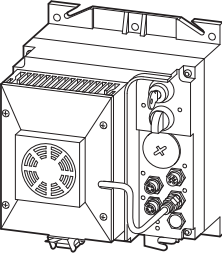
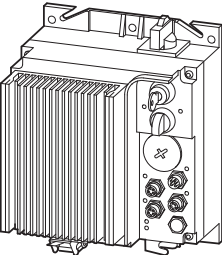
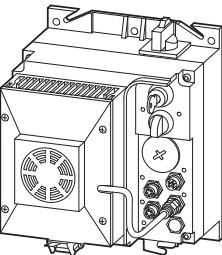



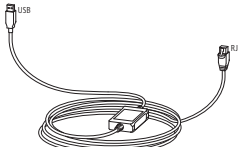
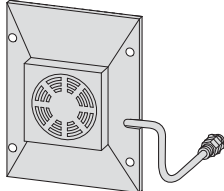
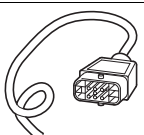
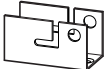
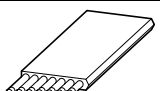
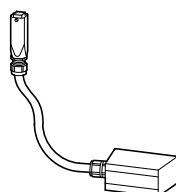

	Rated operational current <sup>1)</sup>		assigned motor rating P <sup>3)</sup>	Control voltage external brake (50/60 Hz) <sup>3)</sup>	Part no. Article no.	Price see price list	with braking resistance <sup>4)</sup>		Std. pack
	I <sub>e</sub> A	P kW					Part no. Article no.	Price see price list	
<b>RASP speed controllers</b>									
Rated operational voltage 400 V AC, 3-phase Mains voltage (50/60Hz) U <sub>LN</sub> 380 (-10%) - 480 (+10%) V AS-Interface profile cable S-7.4 for 31 modules									
	2.4	0.75	1	-	RASP-200AI1S0-C320S1 150168		RASP-210AI1S0-C320S1 150172	1 off	
				230	RASP-202AI1S0-C320S1 150176	RASP-212AI1S0-C320S1 150180			
				400	RASP-204AI1S0-C320S1 169805	RASP-214AI1S0-C320S1 169809			
	3.3	1.1	1.5	-	RASP-300AI1S0-C320S1 150169		RASP-310AI1S0-C320S1 150173		
				230	RASP-302AI1S0-C320S1 150177	RASP-312AI1S0-C320S1 150181			
				400	RASP-304AI1S0-C320S1 169806	RASP-314AI1S0-C320S1 169810			
	4.3	1.5	2	-	RASP-400AI1S0-C320S1 150170		RASP-410AI1S0-C320S1 150174		
				230	RASP-402AI1S0-C320S1 150178	RASP-412AI1S0-C320S1 150182			
				400	RASP-404AI1S0-C320S1 169807	RASP-414AI1S0-C320S1 169811			
	5.6	2.2	3	-	RASP-500AI1SL-C320S1 150171		RASP-510AI1SL-C320S1 150175		
				230	RASP-502AI1SL-C320S1 150179	RASP-512AI1SL-C320S1 150183			
				400	RASP-504AI1SL-C320S1 169808	RASP-514AI1SL-C320S1 169812			
<b>with manual override switch</b>									
	2.4	0.75	1	-	RASP-200AI1S0-C32RS1 150200		RASP-210AI1S0-C32RS1 150204	1 off	
				230	RASP-202AI1S0-C32RS1 150208	RASP-212AI1S0-C32RS1 150212			
				400	RASP-204AI1S0-C32RS1 169813	RASP-214AI1S0-C32RS1 169817			
	3.3	1.1	1.5	-	RASP-300AI1S0-C32RS1 150201		RASP-310AI1S0-C32RS1 150205		
				230	RASP-302AI1S0-C32RS1 150209	RASP-312AI1S0-C32RS1 150213			
				400	RASP-304AI1S0-C32RS1 169814	RASP-314AI1S0-C32RS1 169818			
	4.3	1.5	2	-	RASP-400AI1S0-C32RS1 150202		RASP-410AI1S0-C32RS1 150206		
				230	RASP-402AI1S0-C32RS1 150210	RASP-412AI1S0-C32RS1 150214			
				400	RASP-404AI1S0-C32RS1 169815	RASP-414AI1S0-C32RS1 169819			
	5.6	2.2	3	-	RASP-500AI1SL-C32RS1 150203		RASP-510AI1SL-C32RS1 150207		
				230	RASP-502AI1SL-C32RS1 150211	RASP-512AI1SL-C32RS1 150215			
				400	RASP-504AI1SL-C32RS1 169816	RASP-514AI1SL-C32RS1 169820			



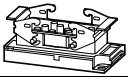

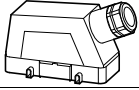
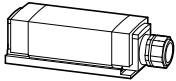
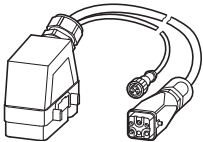
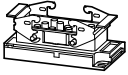
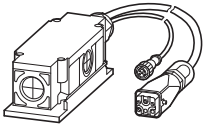
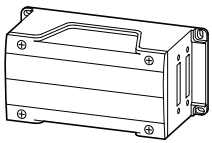

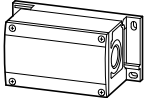
**Instructions**

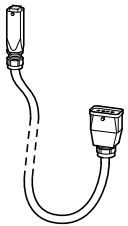
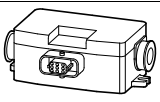

- 1) Rated operational current at an operating frequency of 6 kHz and an ambient air temperature of +40 °C
- 2) for normal internally and externally ventilated 4 pole, three-phase asynchronous motors with 1500 rpm<sup>-1</sup> at 50 Hz or 1800 min<sup>-1</sup> at 60 Hz
- 3) at 400 V, 50 Hz  
at 440 - 480 V, 60 Hz
- 4) for actuation of motors with mechanical brake
- 5) integrated brake chopper with braking resistance for dynamic braking

Description	For use with	Part no. Article no.	Price see price list	Std. pack	Instructions	
<b>Communications</b>						
<b>Operating unit for setting the device parameters</b>						
	with non-volatile parameter memory for copying parameter sets Equipment supplied: including 1 m connection cable with RJ45 connectors	RASP	<b>RASP-KEY-S1</b> 156644	1 off	-	
<b>Programming cable for connecting the device to the PC</b>						
	For configuring the device's parameters with the MaxConnect computer program with RJ 45 plug and USB plug	Length 3.4 m RASP	<b>XMx-CBL-3M4-USB</b> 153448	1 off	-	
<b>Device fans</b>						
<b>RASP device fan for operation at high temperatures without derating</b>						
	Power supply and control via RASP through M12 plug connector Enhanced cooling for ambient temperatures of up to +55 °C for RASP-2..., RASP-3..., and RASP-4... Spare part for RASP-5...	RASP	<b>RASP-FAN-S1</b> 156643	1 off	-	
<b>Motor feeder</b>						
<b>Motor cable for connecting the motor starter to the motor</b>						
	halogen free, 8 x 1.5 mm <sup>2</sup> , plastic plug	Length m 2	RAMO	<b>RAMO-CM1-2M0</b> 164282	1 off	-
		5	RAMO	<b>RAMO-CM1-5M0</b> 164283	1 off	-
		10	RAMO	<b>RAMO-CM1-10M</b> 164284	1 off	-
	halogen free, screened, 4 x 1.5 mm <sup>2</sup> + 2 x (2 x 0.75 mm <sup>2</sup> ), plastic plug	2	RASP	<b>RASP-CM1-2M0</b> 164285	1 off	-
		5	RASP	<b>RASP-CM1-5M0</b> 164286	1 off	-
	<b>Locking brackets for the safe isolation of the motor cables from power</b>					
	For motor cables and motor plugs, disconnection device to EN 60204-1	RAMO-CM1... RASP-CM1...	<b>SET-M-LOCK</b> 272085	1 off	For padlocks with hasp thickness up to 8 mm	
<b>Power supply at flat cable RA-C1</b>						
<b>Flat cable for 400 V AC/24 V DC decentralized power supply or AS-Interface</b>						
	halogen free, 7 x 4 mm <sup>2</sup>	RA-C1...	<b>RA-C1-7X4HF</b> 230860	100 runn. m	Paint film contaminant/ silicon-free	
<b>Power connection cable for connecting the device with the 400 V AC flexible busbar junction</b>						
	with power plug and plug for flexible busbar junction, halogen-free, 5 x 1.5 mm <sup>2</sup>	RAMO RASP RA-C1-PLF	<b>RA-C3/C1-1.5HF</b> 290210	1 off	-	

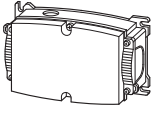
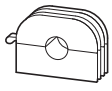

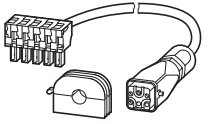
Description	For use with	Part no. Article no.	Price see price list	Std. pack	Instructions
<b>Power supply at flat cable RA-C1</b>					
Flexible busbar junction 400 V AC/24 V DC Connection socket for power connection cable					
 Insulation piercing terminals, terminal socket with lock mechanism	RA-C1-7X4HF RA-C3/C1-1,5HF	<b>RA-C1-PLF</b> 290188		5 off	-
Protection cover for protecting the 400 V AC/24 V DC flexible busbar junction					
 -	RA-C1-PLF	<b>RA-C1-COV</b> 254693		10 off	-
Plug connector for 400 V AC/24 V DC flexible busbar junction					
 Plug insert with hood	RA-C1-PLF	<b>RA-C1-VP-PLM</b> 231574		5 off	Order cable gland V-M25 separately.
Distributor module for feeding the 400-V-AC/24-V-DC of the ribbon cable with a round cable					
 Termination with piercing screws, 2 x V-M25 and 2 x V-M20 knockout plates, connection module with spring-loaded terminals, connection of round cables up to 4 mm <sup>2</sup> .	RA-C1-7X4HF	<b>RA-C1-AM-7</b> 290214		5 off	Order cable gland V-M25 or V-M20 separately.
Power/AS-Interface connection cable for connecting the device with the 400 V AC AS-Interface flexible busbar junction					
 Double cable with outgoer plug (flexible busbar end) and M12 plug and power plug (device end)	RAMO RASP RA-C1-PLF1	<b>RA-C1-PLM/C3-1M5</b> 112624		1 off	Can be used when AS-Interface implemented in flat cable.
400 V AC/AS-Interface flexible busbar junction Connection socket for power/AS-Interface cable					
 Insulation piercing terminals, terminal socket with lock mechanism	RA-C1-7X4HF RA-C1-PLM/C3-1M5	<b>RA-C1-PLF1</b> 116904		1 off	Can be used when AS-Interface implemented in flat cable.
Power/AS-Interface connection cable For connecting the device with 400 V AC/24 V DC/AS-Interface flexible busbar					
 Double cable with connection module (flexible busbar end) and M12 plug as well as power plug (device end), termination with piercing screws, knockouts Length 1.5 m	RAMO RASP RA-C1-7X4HF	<b>RA-C1-AM/C3-1M5</b> 112625		1 off	Can be used when AS-Interface implemented in flat cable.
Distributor module for the 400V AC feeding to the ribbon cable with a round cable					
 With 3 flexible busbar inputs and 2 round cable inputs Connection of round cables 4 mm <sup>2</sup>	RA-C1-7X4HF	<b>RA-C1-VM-7</b> 264244		2 off	Order V-M25/V-M20 cable gland and RA-C1-DF bushing separately.
Flexible busbar bushing for bushing for flat cable in distributor module or control cabinet					
 -	RA-C1-VM-7	<b>RA-C1-DF</b> 264243		10 off	-
Distributor module 24 V DC control voltage is taken from the ribbon cable					
 Termination with piercing screws, connection sockets with screw contacts	RA-C1-7X4HF	<b>RA-C1-VP-AM-2</b> 264315		5 off	Order cable gland V-M20 separately
Flexible busbars for fastening the ribbon cable					
 -	RA-C1-7X4HF	<b>RA-C1-FIX</b> 272086		100 off	One set with 100 clips.

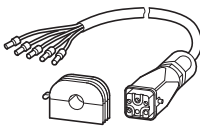
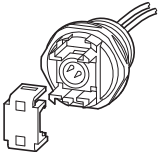
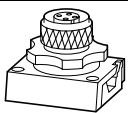
Description	Length m	For use with	Part no. Article no.	Price see price list	Std. pack	Instructions
<b>Power supply at flat cable RA-C1</b>						
End-piece for terminating the ribbon cable		RA-C1-7X4HF	<b>RA-C1-END1</b> 290189		10 off	-
						
Tools						
	For cutting flat cable	RA-C1-7X4HF	<b>RA-C1-CUT</b> 254690		1 off	-
	for removing casing at the ends of the flat cable	RA-C1-7X4HF	<b>RA-C1-AZ-4</b> 272087		1 off	A standard engineer's pliers is required.
<b>Power supply at round cable RA-C2</b>						
Power connection cable for connecting the device with the round cable junction						
	with power plug and plug for round cable junction, halogen-free, 5 x 1.5 mm <sup>2</sup>	1.5	RAMO RASP RA-C2-S1-4	<b>RA-C3/C2-1,5HF</b> 290211	1 off	-
Round cable junction Connection socket for power connection cable						
	for 7 x 2.5/4 mm <sup>2</sup> , 400 V AC and 24 V DC, termination with insulation piercing technology, cable fixing with metal screws, pre-wired socket insert, suitable for cable outer diameters 10 - 13 mm.		RA-C3/C2-1,5HF	<b>RA-C2-S1-4</b> 257830	1 off	Equipment supplied: 1 pairs of gaskets for these cable diameters, 1 lock mechanism.
Blanking plug for closing the last round cable junction in the power line						
	-	RA-C2-S1-4	<b>RA-C2-SBL</b> 265357		10 off	One set with 10 blanking plugs.
<b>Power supply at round cable RA-C4</b>						
Round cable junction Connection socket for power cables from 2.5 - 6 mm <sup>2</sup>						
	T junction via spring-cage terminal, 1.5 to 6 mm <sup>2</sup> and/or plug connection of 0.5 - 4 mm <sup>2</sup> , Enclosure IP65		RA-C4-PPB/C3-1M5 RA-C4-X/C3-1M5	<b>RA-C4-PB65</b> 116905	1 off	Tools required: Stripping tool AM16 from Weidmüller or similar. Enclosure continuous seals must be ordered separately.
Gasket Slotted enclosure bushing seal						
	for Ø 11 - 13 mm EPDM round cable, silicon free and halogen free, IP65		RA-C4-PB65	<b>RA-C4-D13</b> 116907	10 off	-
	for Ø 13 - 15 mm EPDM round cable, silicon free and halogen free, IP65		RA-C4-PB65	<b>RA-C4-D15</b> 116908	10 off	-
	for Ø 15 - 17 mm EPDM round cable, silicon free and halogen free, IP65		RA-C4-PB65	<b>RA-C4-D17</b> 116909	10 off	-
Blanking plug for closing off unused housing openings						
	Enclosure seal, closed, EPDM, silicon free and halogen free, IP65		RA-C4-PB65	<b>RA-C4-D0</b> 116960	10 off	One set with 10 blanking plugs.
Power connection cable for connecting the device with the round cable junction						
	Cable 5 x 1.5 mm <sup>2</sup> , halogen-free, with RA-C4-PPB plug for round cable junction, power plug and gasket IP65	1.5	RAMO RASP RA-C4-PB65	<b>RA-C4-PPB/C3-1M5</b> 116962	1 off	-

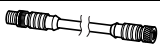
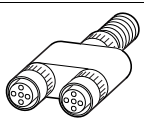
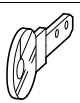
Description	Length m	For use with	Part no. Article no.	Price see price list	Std. pack	Instructions
Power connection cable for user assembly for connecting the device with the round cable junction						
 Cable 5 x 1.5 mm <sup>2</sup> halogen free, with ferrules, power plug and IP65 gasket	1.5	RAMO RASP RA-C4-PB65	<b>RA-C4-X/C3-1M5</b> 116961		1 off	-
<b>AS-Interface connection and sensors</b>						
Connection clip for AS-Interface flat cable to AS-Interface incomer/outgoer for connection modules						
 with integrated AS-Interface overvoltage protection, protection against interference on switch operations or short-circuit, cable termination with insulation displacement		RA-C1-AM-7 RA-C1-AM/C3-1M5 RA-C1-VP-AM-2	<b>RA-C1-AZPG</b> 112978		1 off	-
AS-Interface link M12 connection socket for AS-Interface connection cable						
 IDC termination		RAMO RASP	<b>ZB2-100-AZ1</b> 082667		1 off	-
24V/AS-Interface connection cable for supplying the device with 24 V/AS-Interface						
 with M12 socket and double outgoer for AS-Interface and 24 V, cable termination with insulation displacement	1	RAMO RASP	<b>RA-XAZ2-1M</b> 292253		1 off	-
AS-Interface connection cable for connecting the device with AS-Interface junction						
 with M12 socket and M12 plug, 3-pole	1	RAMO RASP	<b>RA-XM12-1M</b> 272057		1 off	Pins 1, 3, 4 are assigned
Y connector For connecting up to 2 sensors per M12 socket						
 -		RASP	<b>RA-XM12-Y</b> 290424		1 off	-
<b>Spare keys</b>						
for AUTO - OFF/RESET - HAND key-switches						
 Lock mechanism MS1		RAMO RASP	<b>M22-ES-MS1</b> 216416		5 off	-

The Rapid Link 4.0 electronic drive system enables remote and flexible installation in the direct proximity of the drive unit. The entire system is designed with protection to IP65. All electrical connections (mains voltage, motor feeder, sensors) are implemented simply with the standard connectors that are primarily used in materials handling applications.

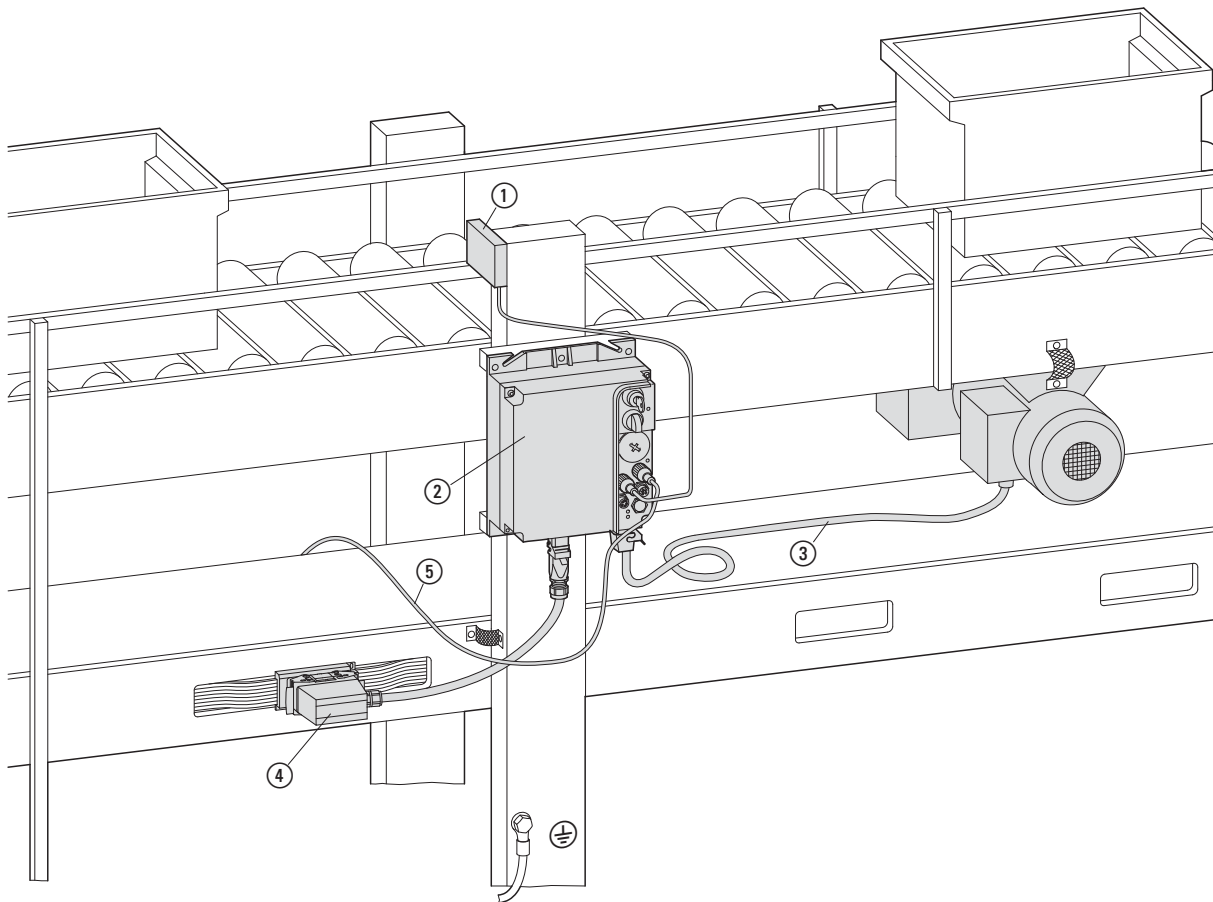

- ① Sensor (light barriers)
- ② RAMO
- ③ Motor connection cable
- ④ Mains connection on power bus
- ⑤ AS-Interface

#### Motor starter selection

All motor starters (RAMO, RASP) can provide electronic motor protection and the additional connection of temperature sensors (thermistor, ThermoClick, PTC). The motor starters are available in the following variants, with or without a lockable repair switch (mains transfer switch):

- RAMO-D, electronic DOL starter for one operating direction.
- RAMO-W, electronic reversing starter (two operating directions).
- RASP, frequency-controlled motor starter with several speeds for two operating direction in assigned ratings.

#### Electrical mains connection

The motor starters can be connected to and operated on 400 V three-phase, star point-earthed AC supply systems (in accordance with IEC 60364) without any restriction. The neutral conductor must be connected for motor starter variants that actuate a 230 V motor brake.

#### Safety and protective device

The power bus must have short-circuit protection. The length of the power bus depends on the upstream group protection. Calculations for design examples are provided in the Rapid Link manual (MN03406003Z):

- PKZM0-25 motor-protective circuit-breaker, max. approx. 40 m.
- FAZ C25/3 miniature circuit-breaker, max. approx. 60 m.
- PKE32/XTU-32 system protective circuit-breaker, 50 m to 220 m.

The group protective devices listed here protect:

- the power bus from overloads and short-circuits.
- the spur lines to the motor starter (RAMO, RASP) from overloads and short-circuits.
- the motor feeder of the RAMO

On the RASP frequency-controlled motor starter, the motor feeder is protected by the internal variable frequency drive.

When using residual current devices, a Type B AC/DC sensitive residual current circuit-breaker must be used with the RASP frequency-controlled motor starter.

#### EMC compliance

All motor starters observe the required EMC limit values when connected as specified. The RASP frequency-controlled motor starter must be provided with a shielded motor cable (RASP-CM1-...) and installed with the specified EMC measures. The internal RFI filter then allows operation in accordance with category C3 in the second environment.

**Terminal Models**

The electrical connection in the power section (mains voltage, motor feeder) is implemented with plug-in terminals in the base.

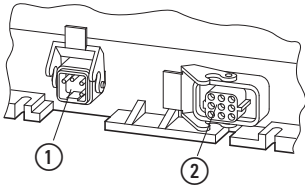

- ① 5-pole power connector for connecting the 3 AC 400 V mains voltage, (N), PE.
- ② 8-pole motor feeder socket as per DESINA specification.

By rotating the base 90 degrees, connection is also possible from the right or left. This makes it possible to keep the operating and connection area and the heat sink on the RASP in the preferred vertical position.

Example RASP:

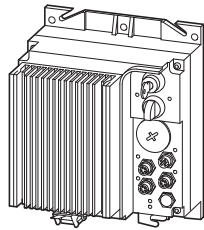

Connection from below (standard)

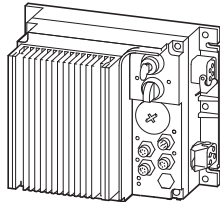

Connection from the right (90 degree rotation of the base to the left)

Three installation systems are available for connecting the power plug to the mains:

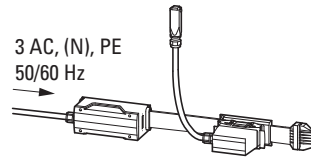

RA-C1, flat cable system

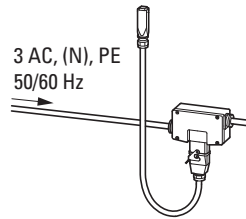

RA-C2, round cable system with plug connectors

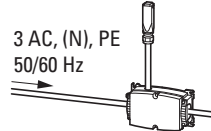

RA-C4, round cable system with contact connectors

Device variants with a repair switch (RAMO-...-C32R..., RASP-...-C32R...) ensure that the drive can be isolated locally from the power supply for repair or maintenance work, even when it is still connected. A padlock can be used to secure the repair switch.

The 8-pole motor feeder can be used to connect:

- a three-phase AC motor (U1, V1, W1, PE),
- a motor brake (B1, B2) with a control voltage of 230 V AC or 400 V AC,
- a thermistor or temperature switch (ThermoClick). These connection cables (T1, T2) can at the same time be used to monitor the motor cable and the connection of the motor feeder plug.

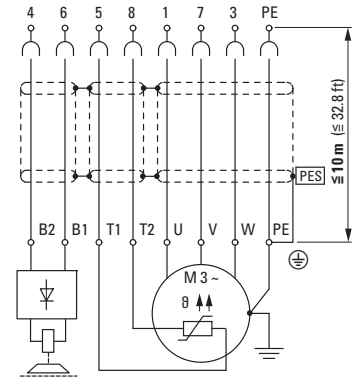

Example: Motor feeder with shielded motor cable on the RASP

**Control level**

The control level features a selector switch (key switch) for selecting automatic mode and manual mode locally. The RAMO-W and RASP motor starters are also provided with a selector switch for reversing the motor direction in manual mode.

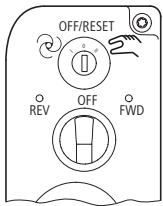

The automatic mode and the control voltage power supply are implemented via the AS-Interface. All connections in the control level (AS-i, sensors etc.) are implemented with M12 plug connectors. For this the M12 connectors just have to be fitted on [1] and rotated to secure them [2] (see illustration below).

The sensor inputs (I3, I4) enable the Rapid Link motor starters to execute sensor-controlled functions immediately and independently of PLC and bus cycle times:

- Interlocked manual operation,
- Quick Stop,
- Rotation direction change (on RAMO-W and RASP),
- Controlled speeds (only RASP)

On the RAMO-DA... and RAMO-WA... a 24 V DC output (max. 1 A, O3) also makes it possible to control external actuators (valves, couplings, indicator lights) directly.

The functions are selected directly on the motor starter via microswitches. On the RASP additional settings (variable frequency drives) can be made from a hand-held terminal or from the parameter software.

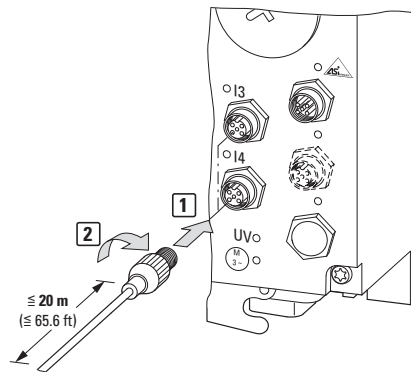

Engineering

Block diagram DOL starter RAMO-D

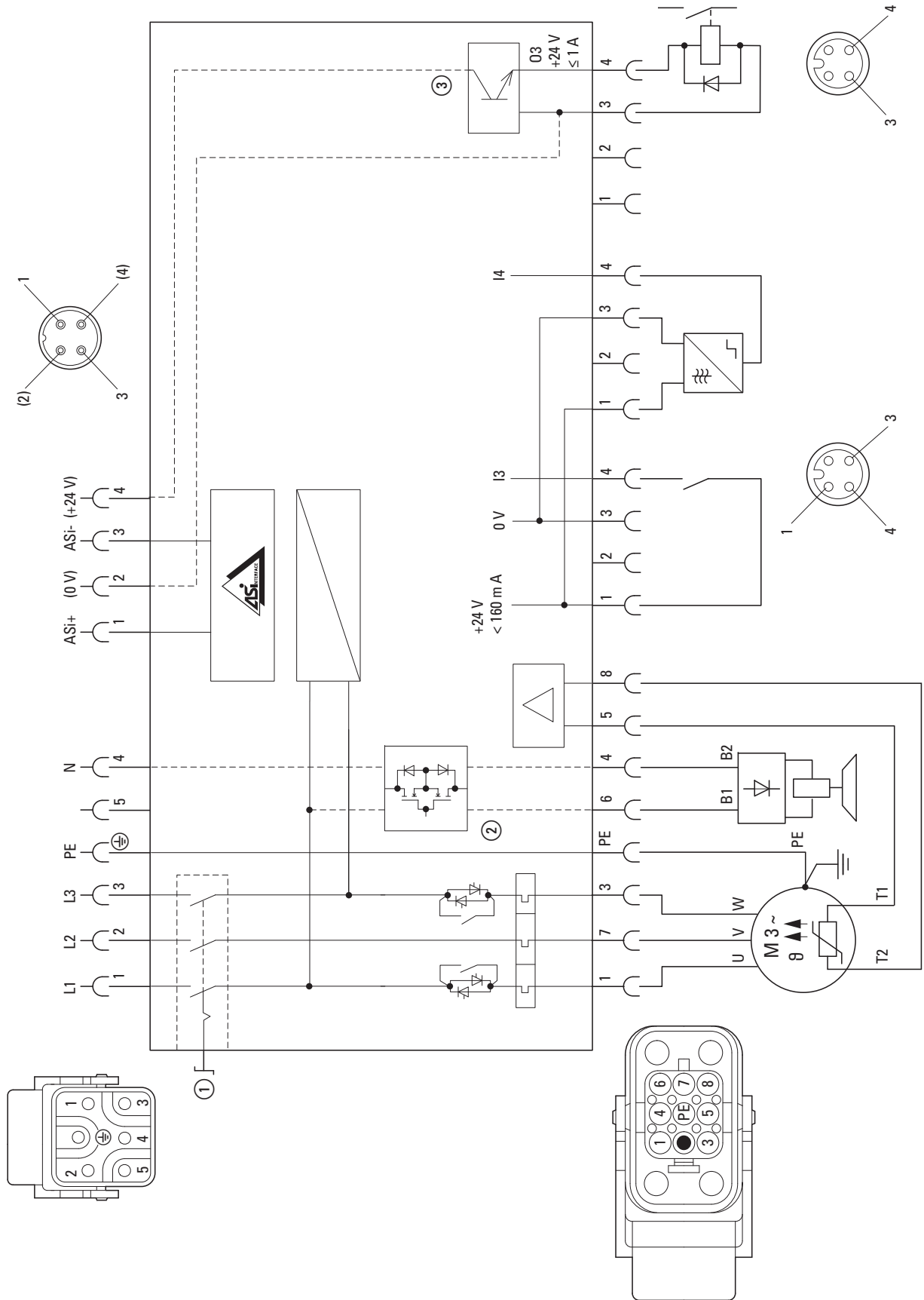

Optional versions:

- ① Repair and maintenance switch RAMO-D...-C32R...
- ② Activation of external brake: 230/277 V at RAMO-Dx2... or 400/480 V at RAMO-Dx4...
- ③ actuator output, RAMO-DA...

Block diagram RAMO-W reversing starter

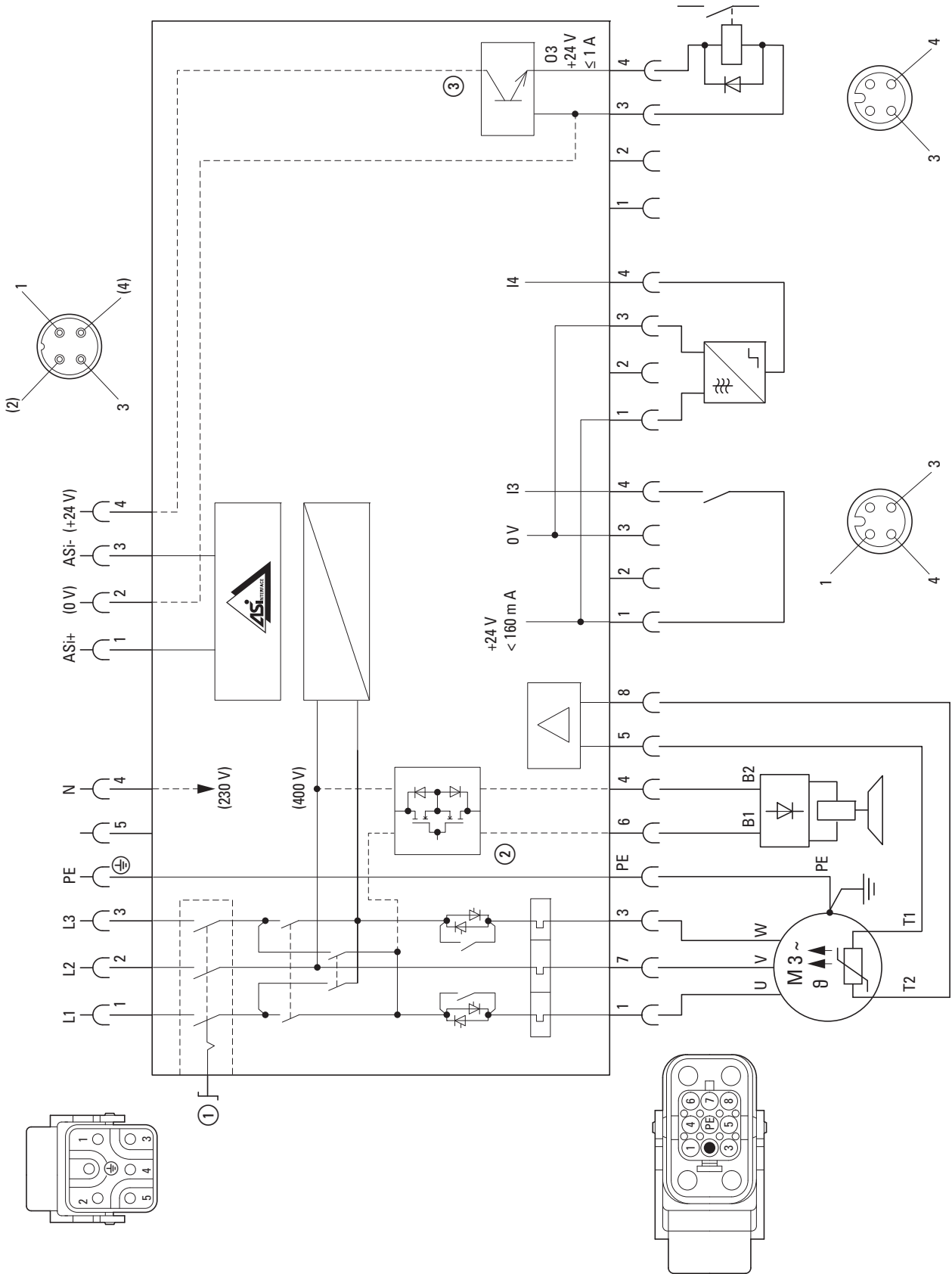

- Optional versions:
- ① Repair and maintenance switch RAMO-W...-C32R...
  - ② Actuation of external brake: 230/277 V on RAMO-Dx2... or 400/480 V on RAMO-Dx4...
  - ③ actuator output, RAMO-WA...

Block diagram RASP with 230V brake

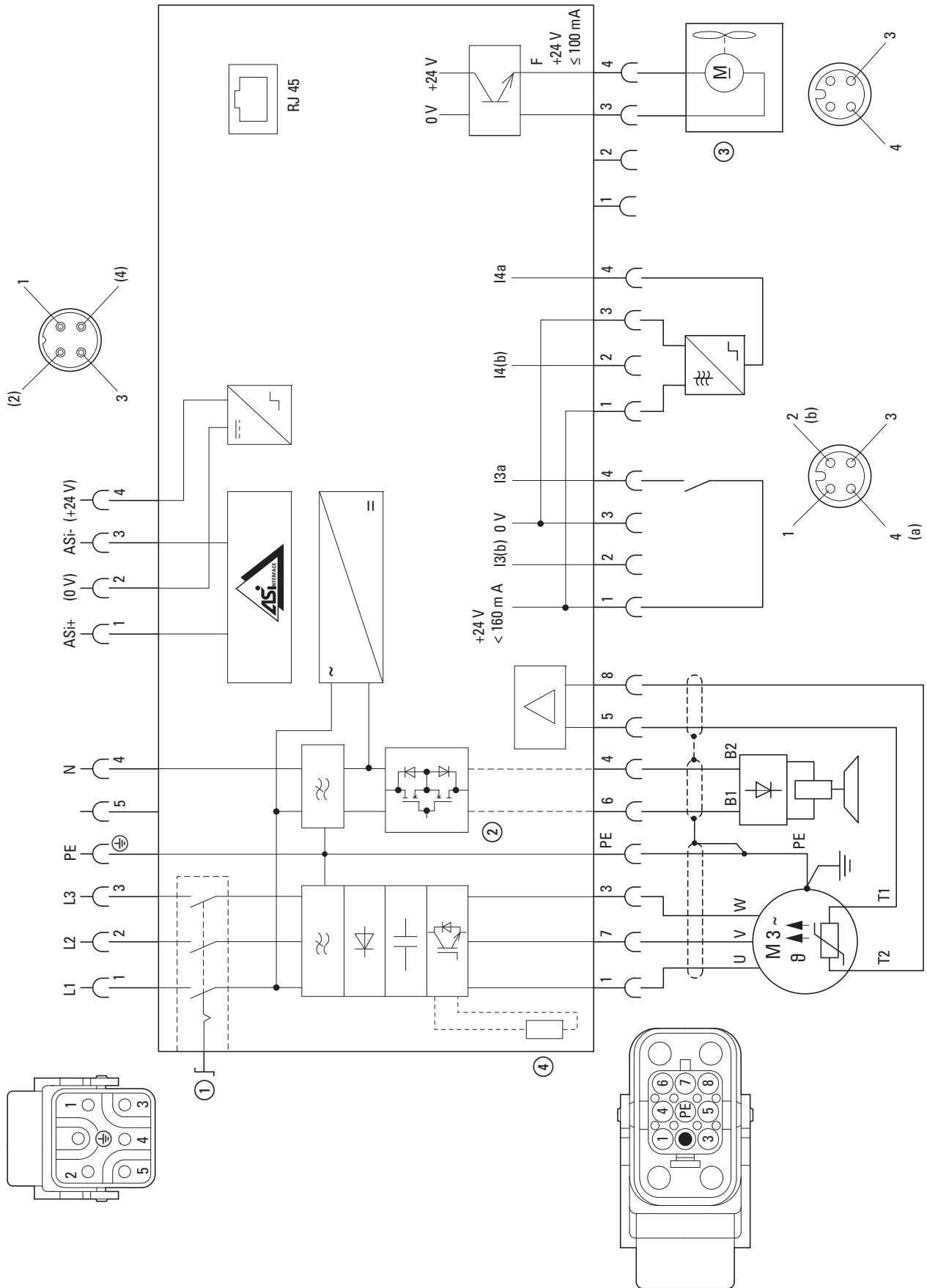

Optional versions:

- ① Repair and maintenance switch, RASP-...C32R...
- ② Activation of external brake (230 V), RASP-...xx2...
- ③ Device fan, RASP-...L-C32...
- ④ internal braking resistance, RASP-x1...

Notes:

Y connector RA-XM12-Y is required in order to connect 4 sensors (I3a, I3b/I4a, I4b) (→ accessory)



Block diagram RASP with 400V brake

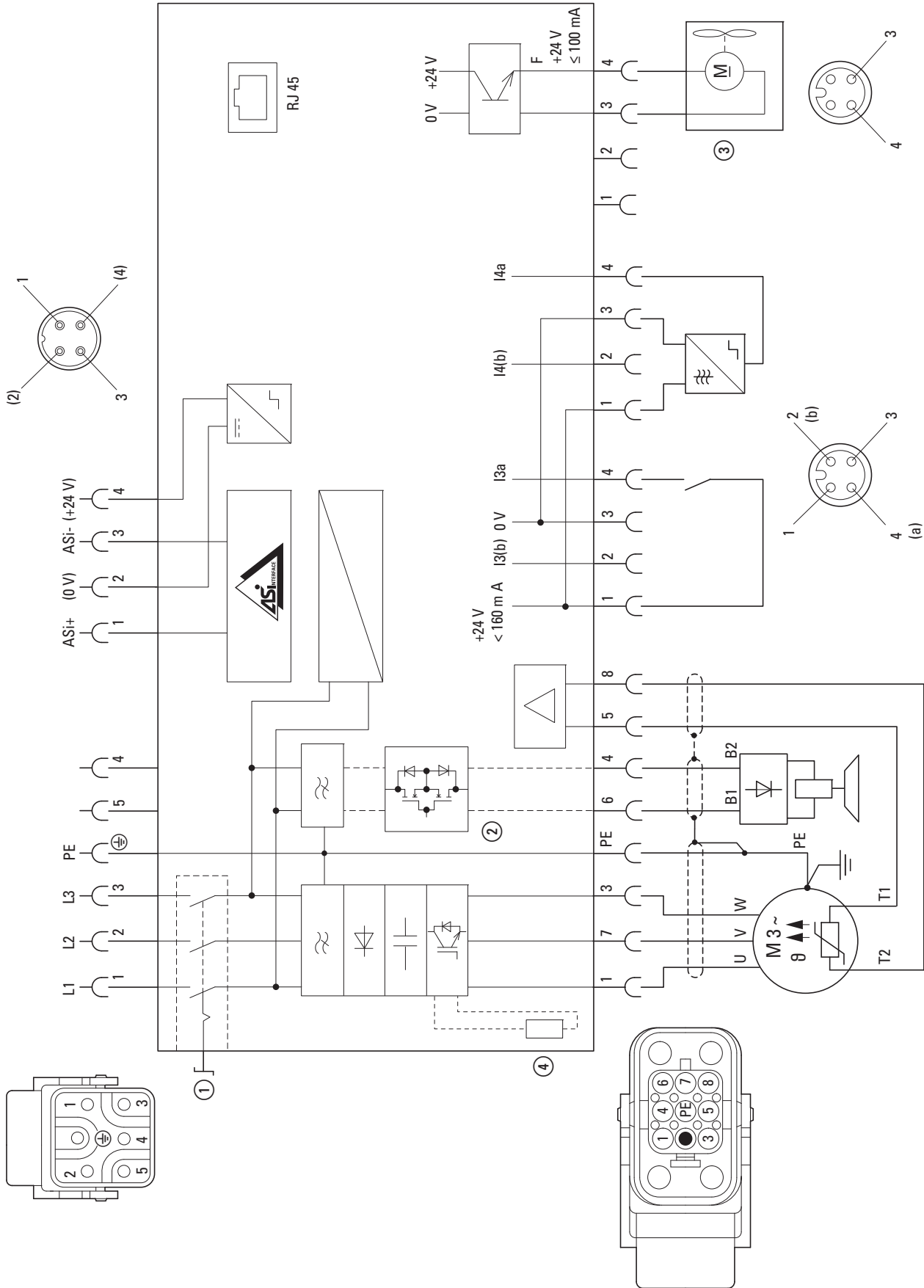

Optional versions:

- ① Repair and maintenance switches, RASP-...C32R...
- ② Activation of external brake (400 V), RASP-...xx4...
- ③ Device fan, RASP-...L-C32...
- ④ internal braking resistance, RASP-x1...

Notes:

Y connector RA-XM12-Y is required in order to connect 4 sensors (I3a, I3b/I4a, I4b) (→ accessory)



# SmartWire-DT® – Cost-optimized Communication for Switchgear

Manufacturers of machines and systems strive to achieve a balance between the maximum level of functionality and cost optimization. SmartWire-DT is a communication system for industrial switchgear based on the concept of continued development in the control panel and peripherals: from control through to protection and switching, and extending to driving, operation and monitoring. One technology from which you will profit, now and in the future.

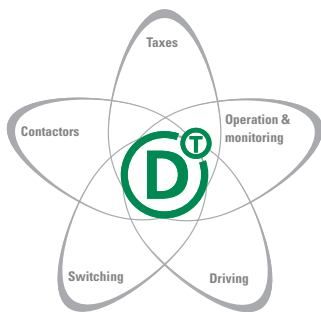

## **Drives and soft starters – communicate with SmartWire-DT®**

Being able to use a controller to directly access all the parameters in soft starters, variable speed starters, and variable frequency drives via SmartWire-DT® is the epitome of ease of operation. For example, this enables users to easily read and overwrite setpoints, as well as to retrieve extended status, error, and diagnostic messages directly and establish absolute data transparency. Moreover, easy-to-use SmartWire-DT® plug-in units make installation fast and error-free, with the resulting connection including the control current supply for DS7 soft starters.

PowerXL™ DE1, DC1, and DA1 devices can be easily expanded with plug-in modules and connected to SmartWire-DT®, with function blocks enabling simple communication with Eaton controllers (PLCs, HMIs). Moreover, more advanced communication is also possible based on the PROFIdrive profile and other profiles as well. This not only makes it possible to configure all drive parameters, but also provides advanced diagnostic options.



---

**SmartWire-DT**

---

System overview	146
-----------------	-----

---

**Ordering**

---

SmartWire-DT Gateways	148
SmartWire-DT accessories	148

---

System overview

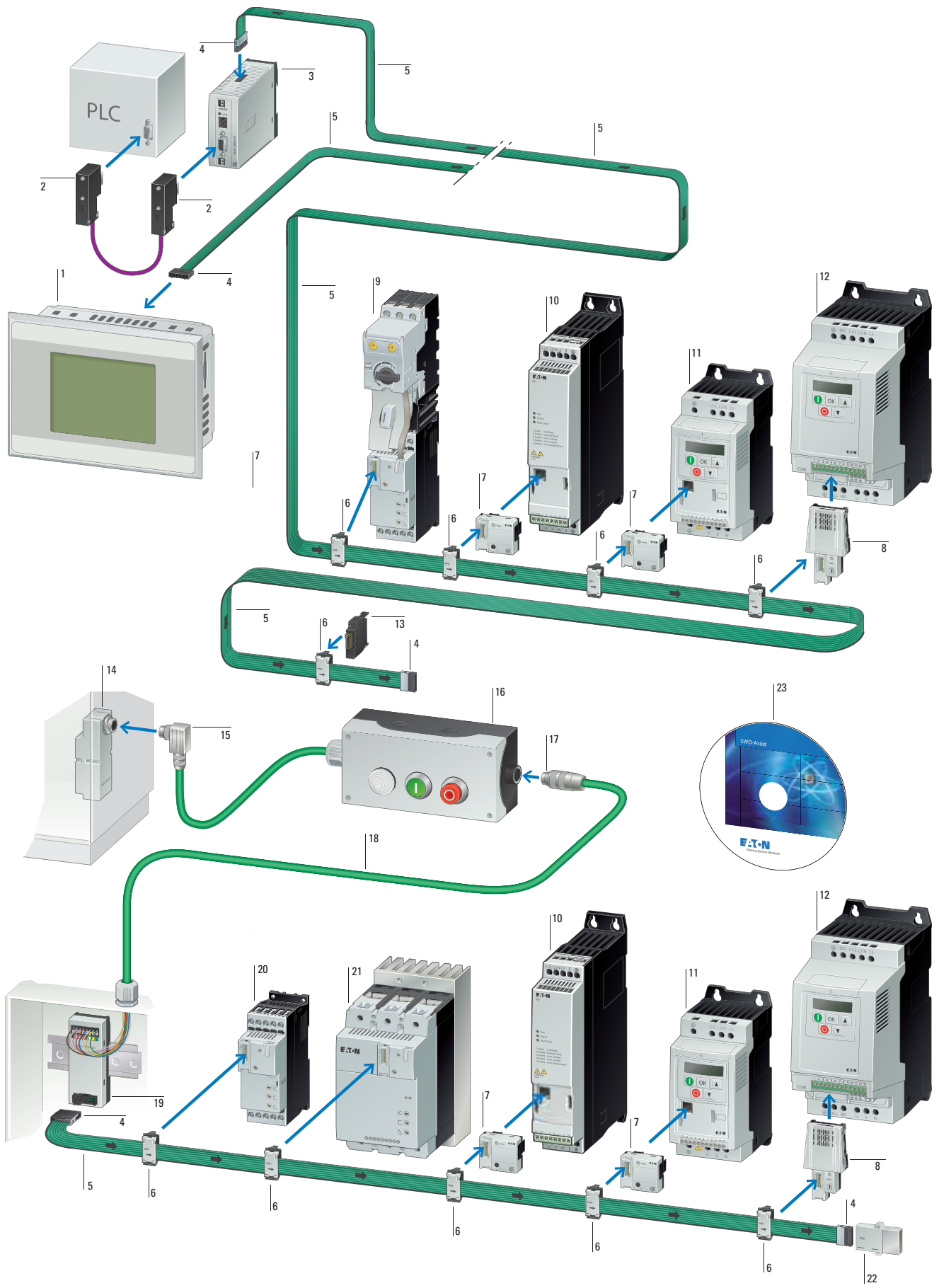

SmartWire-DT HMI-PLC → Industrial Switchgear catalog	1	DE1 variable speed starter → page 10	10	SmartWire-DT plug connector → page 149	17
Data plug Sub-D 9 pole → Industrial Switchgear catalog	2	DC1 variable frequency drive → page 18	11	SmartWire-DT round cable, 8-pole → page 149	18
SmartWire-DT gateways → page 148	3	DA1 variable frequency drive → page 33	12	SmartWire-DT adapter for flat/round cable for top-hat rail mounting → page 149	19
SmartWire-DT blade terminal 8 pole → page 148	4	SmartWire-DT universal module, front mount → page 149	13	Soft starter DS7 < 32 A → page 103	20
SmartWire-DT flat ribbon cable 8 pole → page 148	5	SmartWire-DT control panel cable entry for flat to round cable → page 149	14	Soft starter DS7 > 32 A → page 103	21
SmartWire-DT external device plug 8 pole → page 148	6	SmartWire-DT plug connector → page 149	15	SmartWire-DT bus termination resistor for 8-pole flat band conductor → page 149	22
SmartWire-DT module → page 11	7, 8	RMQ-Titan surface-mounting enclosure with RMQ-Titan elements → Industrial Switchgear catalog	16	SmartWire-DT planning and ordering aid, SWD-Assist	23
Soft starter DS7 with electronic motor protection from PKE → Industrial Switchgear catalog	9				

Note: You can find the entire SmartWire-DT range of products by consulting our industrial main catalog or our online catalog at <http://ecat.moeller.net>

### Features

#### SmartWire-DT HMI-PLC

- with SmartWire-DT master interface and PLC function
- Compact design with light plastic enclosures
- Wide selection of onboard interfaces
- 3.5" , 5.7" or 7" TFT-LCD screen

#### SmartWire-DT Gateways

- Connection of SmartWire-DT to field bus.
- Field bus address setting with dip switches
- Automatic baud rate detection
- Feeding the supply voltage for the SmartWire-DT modules
- Supplies the control voltage for the motor starter or contactor
- Configuration button for automatic addressing of the SmartWire-DT slaves.
- Support of up to 99 SmartWire-DT modules.

















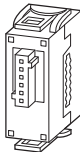

#### SmartWire-DT module

- Function element for connecting to RMQ-Titan pilot devices.
- Function element for connecting to DLM contactors
- Function element for connecting to PKZ/PKE motor-protective circuit-breakers
- Function module for connecting to NZM2,3,4 circuit-breakers
- Connection of digital and analog input/output modules
- DS7 Soft starter connection
- Function element for connecting to PowerXL™ DC1, DA1 variable frequency drives and DE1 variable speed starter

#### SmartWire-DT Assist (SWD-Assist)

- Easy creation of SmartWire-DT networks
- Integrated validity check
- Generation of ordering lists.
- Online-Functionality
  - Simple pre-commissioning
  - Configuration check and comparison
  - Display of parameters and diagnostics
  - easy diagnostics of SmartWire-DT slave
- Free download under: <http://downloadcenter.moeller.net>

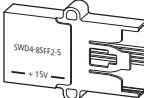









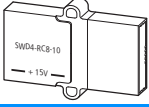





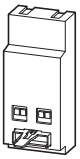

## Ordering

Description	Baud Rates	Number of SmartWire-DT slaves	Part no. Article no.	Price see price list	Std. pack
<b>SmartWire-DT Gateways</b>					
supply of the SmartWire-DT modules and switchgear					
	For connection to PROFIBUS-DP field bus field bus connection through 9-pin SUB-D socket Separate RS232 diagnostics interface (RJ45)	up to 12 MBit/s	Max. 58	<b>EU5C-SWD-DP</b> 116308	1 off  
	For connection to CANopen® field bus Field bus connection through 9-pin SUB-D plug Separate RS232 diagnostics interface (RJ45)	up to 1 MBit/s	Max. 99	<b>EU5C-SWD-CAN</b> 116307	
	For connection to the Ethernet-IP/MODBUS-TCP field bus Field bus connection via Ethernet Switch Separate RS232 diagnostics interface (RJ45)	10/100 MBit/s	Max. 99	<b>EU5C-SWD-EIP-MODTCP</b> 153163	
	for connection to field bus PROFINET as PROFINET IO-Device Field bus connection via Ethernet Switch Separate USB diagnostics interface (Mini-USB)	100 MBit/s	Max. 99	<b>EU5C-SWD-PROFINET</b> 170124	1 off  
<b>Flat band conductor, 8 pole</b>					
For connecting the SmartWire-DT modules within the control panel 8 pole					
	not ready-assembled		Length 100 m	<b>SWD4-100LF8-24</b> 116026	1 off  
	prefabricated with two blade terminals SWD4-8MF2		Length 3 m	<b>SWD4-3LF8-24-2S</b> 116027	
			Length 5 m	<b>SWD4-5LF8-24-2S</b> 116028	
			Length 10 m	<b>SWD4-10LF8-24-2S</b> 116029	
<b>External device plugs</b>					
	For connecting the ribbon cable to SmartWire-DT modules in the control panel			<b>SWD4-8SF2-5</b> 116022	10 off  
<b>Link</b>					
	For bridging open mounting locations for external device plugs Front fixing			<b>SWD4-SEL8-10</b> 116021	5 off  
<b>Blade terminal</b>					
	For connecting the ribbon cable to the gateway, power feeder module, coupling, SWD4-RC8-10 bus termination resistor			<b>SWD4-8MF2</b> 116023	10 off  
<b>Coupling</b>					
	via SWD4 8MF2- blade terminal to connect ribbon cable			<b>SWD4-8SFF2-5</b> 116024	1 off  

## Notes

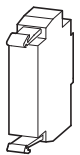

Information relevant for export to North America → Page 149

Description	Part no. Article no.	Price see price list	Std. pack						
<b>Network terminator</b>									
 <p>For the SmartWire-DT bus termination resistor on the SmartWire-DT ribbon cable</p>	<b>SWD4-RC8-10</b> 116020		1 off  						
<b>Cable adapters</b>									
 <p>SWD cable adapters</p>	<b>SWD4-8FRF-10</b> 121377		1 off  						
<b>Switch cabinet bushing</b>									
<p>For transition from SWD ribbon cable to SWD round cable Connection of ribbon cable with blade terminal SWD4-8MF2 8 pole double conductor run pluggable Additional control voltage feeder for the motor starter and contactors.</p>									
 <p>Connection round cable via socket</p>	<b>SWD4-SFL8-20</b> 121380		1 off  						
<p>Connection round cable via plug</p>	<b>SWD4-SML8-20</b> 121381								
<b>Round conductor</b>									
<p>For laying the SmartWire-DT network outside of the control panel.</p>									
 <p>For connecting pilot devices in CI surface mounting enclosures 8 pole HK-S0-Li2YY, 8 mm diameter Length 50 m</p>	<b>SWD4-50LR8-24</b> 116030		1 off  						
<b>Connectors for SWD round conductors</b>									
 <p>8 pole socket Straight</p>	<b>SWD4-SF8-67</b> 116033		1 off  						
<p>8-pinplug connector Straight</p>	<b>SWD4-SM8-67</b> 116034								
 <p>8 pole socket 90° angled</p>	<b>SWD4-SF8-67W</b> 116035								
<p>8-pinplug connector 90° angled</p>	<b>SWD4-SM8-67W</b> 116036								
<b>Tools for plugs</b>									
 <p>Pliers for connecting external device plug and ribbon cable</p>	<b>SWD4-CRP-1</b> 116025		1 off						
<p>Pliers for making contacts with blade terminals and ribbon cables</p>	<b>SWD4-CRP-2</b> 116699								
<b>Universal slave</b>									
<p>for configured but not yet installed SmartWire-DT slaves Front mount</p>									
 <p>Configuration</p> <table border="1" data-bbox="359 1556 470 1624"> <tr> <td>1</td> <td>3</td> <td>2</td> </tr> <tr> <td>4</td> <td>6</td> <td>5</td> </tr> </table>	1	3	2	4	6	5	<b>M22-SWD-NOP</b> 147637		20 off  
1	3	2							
4	6	5							

**Notes**  **Information relevant for export to North America**

UL File No. E29184  
 UL Category  
 Control No. NKCR  
 CSA File No. 2324643  
 CSA Class No. 3211-07  
 North America  
 Certification UL listed, CSA certified

**EU5C-SWD-PROFINET**

UL File No. E221530  
 UL Category  
 Control No. NRQA  
 CSA File No. UL report applies to both US and Canada  
 North America  
 Certification UL listed, CSA certified

## Full-load motor-running currents in amperes corresponding to various AC horsepower ratings

HP	110 - 120 V			220 - 240 V <sup>a,b</sup>			360 - 380 V		440 - 480 V			550 - 600 V		
	Single phase	Two phase	Three phase	Single phase	Two phase	Three phase	Single phase	Three phase	Single phase	Two phase	Three phase	Single phase	Two phase	Three phase
1/10	3.0	-	-	1.5	-	-	1.0	-	-	-	-	-	-	-
1/8	3.8	-	-	1.9	-	-	1.2	-	-	-	-	-	-	-
1/6	4.4	-	-	2.2	-	-	1.4	-	-	-	-	-	-	-
1/4	5.8	-	-	2.9	-	-	1.8	-	-	-	-	-	-	-
1/3	7.2	-	-	3.6	-	-	2.3	-	-	-	-	-	-	-
1/2	9.8	4.0	4.4	4.9	2.0	2.2	3.2	1.3	2.5	1.0	1.1	2.0	0.8	0.9
3/4	13.8	4.8	6.4	6.9	2.4	3.2	4.5	1.8	3.5	1.2	1.6	2.8	1.0	1.3
1	16.0	6.4	8.4	8.0	3.2	4.2	5.1	2.3	4.0	1.6	2.1	3.2	1.3	1.7
1-1/2	20.0	9.0	12.0	10.0	4.5	6.0	6.4	3.3	5.0	2.3	3.0	4.0	1.8	2.4
2	24.0	11.8	13.6	12.0	5.9	6.8	7.7	4.3	6.0	3.0	3.4	4.8	2.4	2.7
3	34.0	16.6	19.2	17.0	8.3	9.6	10.9	6.1	8.5	4.2	4.8	6.8	3.3	3.9
5	56.0	26.4	30.4	28.0	13.2	15.2	17.9	9.7	14.0	6.6	7.6	11.2	5.3	6.1
7-1/2	80.0	38.0	44.0	40.0	19.0	22.0	27.0	14.0	21.0	9.0	11.0	16.0	8.0	9.0
10	100	48.0	56.0	50.0	24.0	28.0	33.0	18.0	26.0	12.0	14.0	20.0	10.0	11.0
15	135	72.0	84.0	68.0	36.0	42.0	44.0	27.0	34.0	18.0	21.0	27.0	14.0	17.0
20	-	94.0	108	88.0	47.0	54.0	56.0	34.0	44.0	23.0	27.0	35.0	19.0	22.0
25	-	118	136	110	59.0	68.0	70.0	44.0	55.0	29.0	34.0	44.0	24.0	27.0
30	-	138	160	136	69.0	80.0	87.0	51.0	68.0	35.0	40.0	54.0	28.0	32.0
40	-	180	208	176	90.0	104	112	66.0	88.0	45.0	52.0	70.0	36.0	41.0
50	-	226	260	216	113	130	139	83.0	108	56.0	65.0	86.0	45.0	52.0
60	-	-	-	-	133	154	-	103	-	67.0	77.0	-	53.0	62.0
75	-	-	-	-	166	192	-	128	-	83.0	96.0	-	66.0	77.0
100	-	-	-	-	218	248	-	165	-	109	124	-	87.0	99.0
125	-	-	-	-	-	312	-	208	-	135	156	-	108	125
150	-	-	-	-	-	360	-	240	-	156	180	-	125	144
200	-	-	-	-	-	480	-	320	-	208	240	-	167	192
250	-	-	-	-	-	602	-	403	-	-	302	-	-	242
300	-	-	-	-	-	-	-	482	-	-	361	-	-	289
350	-	-	-	-	-	-	-	560	-	-	414	-	-	336
400	-	-	-	-	-	-	-	636	-	-	477	-	-	382
500	-	-	-	-	-	-	-	786	-	-	590	-	-	472

<sup>a)</sup>To obtain full-load currents for 200 and 208 V motors, increase corresponding 220 - 240 V ratings by 15 and 10 percent, respectively.

<sup>b)</sup>To obtain full-load currents for 265 and 277 V motors, decrease corresponding 220 - 240 V ratings by 13 and 17 percent, respectively.

Zitiert aus "Power Conversion Equipment - UL 508C, May 3, 2002".

Reproduced from UL 508 C, Power Conversion Equipment, 3rd edition (May 2, 2002) with permission of Underwriters Laboratories Inc.



**Minimum fuse sizes for short-circuit protection of three-phase motors**  
The maximum value depends on the switching device or the overload relay.

Motor power			230 V			400 V			440 V			500 V			690 V		
			Motor rated operational current	Fuse		Motor rated operational current	Fuse		Motor rated operational current	Fuse		Motor rated operational current	Fuse		Motor rated operational current	Fuse	
				Starting DOL	Y/Δ		Starting DOL	Y/Δ		Starting DOL	Y/Δ		Starting DOL	Y/Δ		Starting DOL	Y/Δ
kWh	p.f.	η (%)	A	A	A	A	A	A	A	A	A	A	A	A	A	A	
0.06	0.7	58	0.37	2	–	0.21	2	–	0.19	2	–	0.17	2	–	0.12	2	–
0.09	0.7	60	0.54	2	–	0.31	2	–	0.28	2	–	0.25	2	–	0.18	2	–
0.12	0.7	60	0.72	4	2	0.41	2	–	0.37	2	–	0.33	2	–	0.24	2	–
0.18	0.7	62	1.04	4	2	0.6	2	–	0.54	2	–	0.48	2	–	0.35	2	–
0.25	0.7	62	1.4	4	2	0.8	4	2	0.76	2	–	0.7	2	–	0.5	2	–
0.37	0.72	66	2	6	4	1.1	4	2	1	4	2	0.9	2	2	0.7	2	–
0.55	0.75	69	2.7	10	4	1.5	4	2	1.4	4	2	1.2	4	2	0.9	4	2
0.75	0.79	74	3.2	10	4	1.9	6	4	1.7	4	2	1.5	4	2	1.1	4	2
1.1	0.81	74	4.6	10	6	2.6	6	4	2.4	4	2	2.1	6	4	1.5	4	2
1.5	0.81	74	6.3	16	10	3.6	6	4	3.3	6	4	2.9	6	4	2.1	6	4
2.2	0.81	78	8.7	20	10	5	10	6	4.6	10	6	4	10	4	2.9	10	4
3	0.82	80	11.5	25	16	6.6	16	10	6	16	10	5.3	16	6	3.8	10	4
4	0.82	83	14.8	32	16	8.5	20	10	7.7	16	10	6.8	16	10	4.9	16	6
5.5	0.82	86	19.6	32	25	11.3	25	16	10.2	20	10	9	20	16	6.5	16	10
7.5	0.82	87	26.4	50	32	15.2	32	16	13.8	25	16	12.1	25	16	8.8	20	10
11	0.84	87	38	80	40	21.7	40	25	19.8	32	25	17.4	32	20	12.6	25	16
15	0.84	88	51	100	63	29.3	63	32	26.6	50	32	23.4	50	25	17	32	20
18.5	0.84	88	63	125	80	36	63	40	32.8	63	32	28.9	50	32	20.9	32	25
22	0.84	92	71	125	80	41	80	50	37	80	40	33	63	32	23.8	50	25
30	0.85	92	96	200	100	55	100	63	50	100	63	44	80	50	32	63	32
37	0.86	92	117	200	125	68	125	80	61	125	80	54	100	63	39	80	50
45	0.86	93	141	250	160	81	160	100	74	125	100	65	125	80	47	80	63
55	0.86	93	173	250	200	99	200	125	90	125	100	79	160	80	58	100	63
75	0.86	94	233	315	250	134	200	160	122	160	125	107	200	125	78	160	100
90	0.86	94	279	400	315	161	250	200	146	200	160	129	200	160	93	160	100
110	0.86	94	342	500	400	196	315	200	179	250	200	157	250	160	114	200	125
132	0.87	95	401	630	500	231	400	250	210	250	250	184	250	200	134	250	160
160	0.87	95	486	630	630	279	400	315	254	315	250	224	315	250	162	250	200
200	0.87	95	607	800	630	349	500	400	318	400	315	279	400	315	202	315	250
250	0.87	95	–	–	–	437	630	500	397	630	400	349	500	400	253	400	315
315	0.87	96	–	–	–	544	800	630	495	630	630	436	630	500	316	500	400
400	0.88	96	–	–	–	683	1000	800	621	800	800	547	800	630	396	630	400
450	0.88	96	–	–	–	769	1000	800	699	800	800	615	800	630	446	630	630
500	0.88	97	–	–	–	–	–	–	–	–	–	–	–	–	491	630	630
560	0.88	97	–	–	–	–	–	–	–	–	–	–	–	–	550	800	630
630	0.88	97	–	–	–	–	–	–	–	–	–	–	–	–	618	800	630

**Instructions**  
The rated motor currents apply to normal internally and surface-cooled three-phase motors with 1500 rpm.  
DOL starting: Starting current max. 6 × rated motor current.  
Starting time max. 5 s.  
Y/Δ-start: Starting current max. 2 × motor rated current.  
Starting time max. 15 s.  
Set overload relay in line to 0.58 × motor rated current.

Fuse ratings at Y/Δ starting apply also to three-phase slipring motors.  
For higher rated currents, starting currents and/or longer starting times, larger fuses will be required. Table applies for time delay and gL fuses (VDE 0636)

**For LV h.b.c. fuse with aM characteristics the fuse should be equal to the rated operational current.**

**Drives engineering selection criteria**

Each drive task requires a drive motor. The speed, torque and controllability of each motor must fulfill the requirements of the task. The following generally applies: the application determines the drive. The drive motor most frequently used worldwide in industrial plants and large buildings is the 3-phase asynchronous motor. Its robust and simple construction as well as its high degrees of protection and standard types are the main features of this inexpensive electric motor.

**Motor connection**

When connecting a 3-phase motor to the mains supply, the data on the rating plate of the motor must correspond to the mains voltage and frequency. The standard connection is implemented via six screw terminals in the terminal box of the motor and with two types of circuit, the star connection and the delta circuit, depending on the mains voltage.

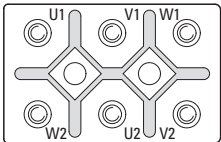

The rotation direction of a motor is always determined by directly looking at the drive shaft of the motor (from the drive end). On motors with two shaft ends, the driving end is denoted with D (= Drive), the non-driving end with N (= No drive).

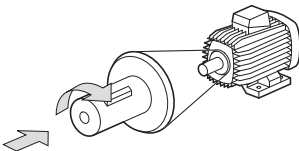

Regardless of the circuit type and the type of three-phase asynchronous motor, the connections must be labeled, so that their alphabetical sequence (e.g. U1, V1, W1) corresponds with the order of the mains voltage phase sequence (L1, L2, L3) and causes the motor to rotate clockwise.

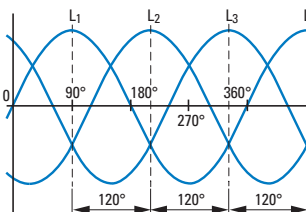

On the three-phase asynchronous motor, three windings are arranged offset from each other by 120°/p (p = number of pole pairs). To generate a rotating field in the motor, an alternating voltage is applied to each phase in turn at a time delay of 120°.

The effect of inductance causes the rotation field and torque to be formed in the rotor winding. The speed of the motor thus depends on the number of pole pairs and the frequency of the supply voltage. The operating direction can be reversed by swapping over two of the supply phases.

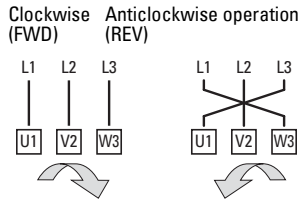

FWD = forward run (clockwise rotation field)  
REV = reverse run (anticlockwise rotation field)

**Information on the rating plate**

The electrical and mechanical rating data of the motor must be stated on its rating plate (IEC 34-1, VDE 0530). The data on the rating plate describes the stationary operation of the motor in the area of its operating point (MN, e.g. at 400 V and 50 Hz). The operational data is unstable in the motor start phase. The following examples show the rating plates for two motors with a motor shaft output of 4 kW and the respective connection circuits on a 3-phase AC network with 400 V and 50 Hz.

**Star circuit**

230 / 400 V	Δ / Y	14.5 / 8.5 A
S1	4.0 kW	cos φ 0.82
1410 min <sup>-1</sup>		50 Hz
IP 54		Iso. KI F

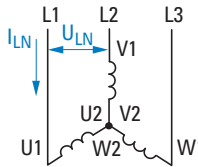

$$U_{LN} = \sqrt{3} \times U_W, \quad I_{LN} = I_W$$

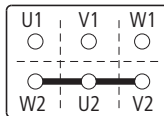

- With the specified 230/400 V voltage, this motor must be connected to the 3-phase system (U<sub>LN</sub> = 400 V) in a star-connected circuit.
- The voltage of each motor winding is designed for 230 V. The windings must therefore be connected in sequence to the phase voltage (400 V).
- The three winding phases (W2-U2-V2) are configured in the terminal box to the so-called star point. The voltage of the individual phases to the star point is 230 V (= U<sub>W</sub>).

**Delta circuit**

400 / 690 V	Δ / Y	8.5 / 4.9 A
S1	4.0 kW	cos φ 0.82
1410 min <sup>-1</sup>		50 Hz
IP 54		Iso. KI F

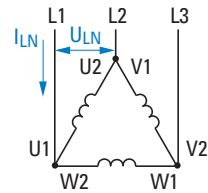

$$U_{LN} = U_W, \quad I_{LN} = \sqrt{3} \times I_W$$

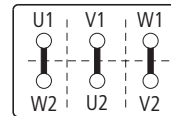

- With the specified 400/690 V voltage, this motor must be connected to the 3-phase system (U<sub>LN</sub> = 400 V) in a delta circuit.
- Each motor winding is designed here for the maximum phase voltage of 400 V and can be connected directly.
- The three winding phases (U1 – W2, V1 – U2, W1 – V2) are combined in the terminal box and connected directly to the individual phases.

**Startup characteristics**

The following figure shows the characteristic startup curves of a 3-phase asynchronous motor.

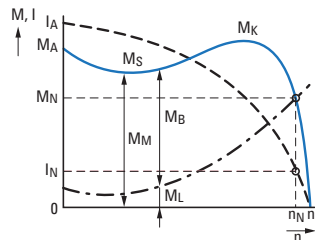

- I<sub>A</sub>: Starting current
- I<sub>N</sub>: Rated operational current at the operating point
- M<sub>A</sub>: Starting torque
- M<sub>B</sub>: Accelerating torque (M<sub>M</sub> > M<sub>L</sub>)
- M<sub>K</sub>: Breakdown torque
- M<sub>L</sub>: Load torque
- M<sub>M</sub>: Motor torque
- M<sub>N</sub>: Rated load torque, (stable operating point, intersection point of the 3-phase speed torque characteristic with the load characteristic)
- M<sub>S</sub>: Pull-up torque
- n: Speed (actual value)
- n<sub>N</sub>: Rated speed at the operating point
- n<sub>S</sub>: Synchronous speed (n<sub>S</sub> - n<sub>N</sub> = slip speed s)

Synchronous speed:

$$n_s = \frac{f}{p}$$

Slip speed in %:

$$s = \frac{n_s - n}{n_s} \cdot 100\%$$

3-phase asynchronous motor speed:

$$n = \frac{f}{p} \cdot (1 - s)$$

- f: Frequency of voltage in Hz (= s<sup>-1</sup>)
- n: Speed in r.p.m.
- p: Number of pole pairs
- s: Slip speed in r.p.m.

Electric power:

$$P_1 = U \times I \times \sqrt{3} \times \cos \varphi$$

- P<sub>1</sub>: Electrical power in W
- U: Rated operating voltage in V
- I: Rated operational current in A
- cos φ: Power factor

Motor output (power equation):

$$P_2 = \frac{M_N \times n}{9550}$$

- P<sub>2</sub>: Mechanical shaft output power in kW
- M<sub>N</sub>: Rated torque in Nm
- n: Speed in r.p.m.

Efficiency:

$$\eta = \frac{P_2}{P_1}$$



# Planning safety and process optimization – CAD data at the click of a mouse!

**ePLAN**<sup>®</sup>

- 10,800 article data items and macros
- Convenient selection tool
- Version P8



- Models for approx. 11,000 products
- 80 different neutral & native formats

**URL**

[www.eaton.eu/cad](http://www.eaton.eu/cad)

Eaton is providing its customers with CAD data to offer optimum support during planning. Both electrical and mechanical design data can be called up quickly and conveniently from the Internet at any time. This reduces processing times, minimizes errors and thus reduces costs already in the engineering phase of control panels, systems and machinery.

**eCAD:** Eaton has product data and macros available for EPLAN Electric P8. After downloading the small EPLANSelection program, you will not only be able to select the items you need from a database containing more than 10,800 products, but will also be able to export them and import them into your own EPLAN item database.

**mCAD:** Eaton makes 2D and 3D data available for more than 11,000 products. Over 80 different neutral and native formats guarantee compatibility with the project engineering systems of the customer. The models can either be integrated directly into the planning software from the Partcommunity Portal on the Internet or via the CADENAS Partsolution software.



# Worldwide export of machines and plants

European machine and system building and worldwide exports are closely related. Even if you don't export your machines at present, you should be prepared for it in the future. Eaton provides switchgear and protective devices with all the essential approvals and certificates for machine and system building. In most countries around the world, conformity with international standards is the sole requirement for successful exports. This is because components in these locations are governed by compliance with well known and established IEC standards. In this respect, the European CE mark is not only the passport for exports within Europe but also far beyond its borders.



## World market equipment for machine building

Nearly all the switchgear and protective devices of Eaton's Moeller® series are world market devices. Each product line thus carries all the approvals and certification marks required for worldwide use.

These product lines include those for

- Pilot devices, limit switches
- Contactors and various timing and special relays
- Motor-protective circuit-breakers and relays
- Electronic components and systems.

With circuit-breakers and switch-disconnectors, Eaton offers IEC devices for use in most countries in the world and NA devices with virtually the same dimensions and the same accessories for the North American market. This considerably simplifies device selection since the North American standards often involve the need for considerably different technical specifications.

# Electrical engineering products and their applications are not harmonized internationally.



The greatest differences to the IEC world are in North America, i.e. the USA and Canada. For many newcomers to the export business, it is initially surprising to experience the very different approaches and solutions.

Special components, such as handles for main switches that can only be operated by the intentional switching of an

additional handle when the control panel door is opened, may sometimes be required for export to North America. Likewise, the European motor-protective circuit-breaker is only accepted with an upstream protective device or with larger air and creepage distances at the incoming terminals. Eaton is the competent partner of choice for export-related issues here.

## Qualified information is a critical key to success

The Eaton Main Catalogue for Moeller® series products provides reliable information for machine and panel builders on the approval of components deployed for North American market. Each selection page provides information such as the relevant product standard, the E-File Number, the Category Control Number or the CSA Class Number. Many customers incorporate this information in their parts lists in order to be well prepared for the acceptance procedures.

Info	10-2-8177A 10100	10-2-8177E2 10100
Information relevant for export to North America	<ul style="list-style-type: none"> <li>Product Standards: UL 508, CSA-C22.2 No. 14-05, IEC/EN 60947-3; CE marking</li> <li>UL File No.: E36332</li> <li>UL CCN: NLRV</li> <li>CSA File No.: 12528</li> <li>CSA Class No.: 3211-05</li> <li>NA Certification: UL Listed, CSA certified</li> <li>Suitable for Branch circuits</li> <li>Degree of Protection: IEC: IP65; UL/CSA Type 3R, 12</li> </ul>	<ul style="list-style-type: none"> <li>UL 508, CSA-C22.2 No. 14-05, IEC/EN 60947-3; CE marking</li> <li>UL File No.: E36332</li> <li>UL CCN: NLRV</li> <li>CSA File No.: 12528</li> <li>CSA Class No.: 3211-05</li> <li>NA Certification: UL Listed, CSA certified</li> <li>Suitable for Branch circuits</li> <li>Degree of Protection: IEC: IP65; UL/CSA Type 3R, 12</li> </ul>

Up to 13 data items are listed here for each product, such as the suitability for use in feeders or branch circuits, the maximum operating voltage, or the North American degree of protection, such as UL / CSA Type 4X. The Main Catalogue also contains a glossary with explanations of the American terms.

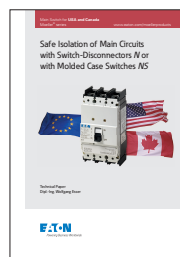
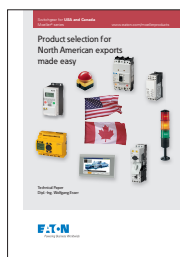
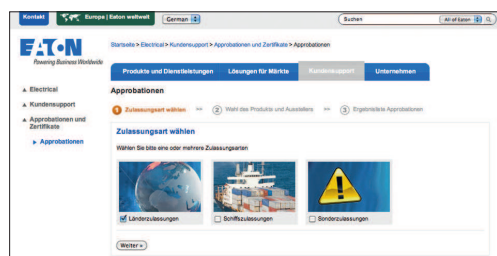

The link <http://applications.eaton.eu> shows the relevant approvals or permits for each component type. This therefore enables you to view the certificates provided or, depending on the test authority, also the product report. The information given is the same as what is provided in the databases of the authorities.

Anyone wishing to avoid unfortunate experiences, should make use beforehand of the large number of publications that Eaton is offering on the issue of exports to North America. They contain the implementation of the codes & standards and a description of different practices.

These technical articles can be accessed via <http://www.eaton.eu/Europe/OurCompany/News/Publications/index.htm> They can be downloaded free of charge.



## To find the right contact person:

At Eaton, we believe that building and maintaining strong relationships with our customers is something that deserves our undivided attention.

This is why you can rest assured knowing that you will be able to count on us for every project from the very start. To find out whom to contact for your needs, please visit our website:

In just a few steps, we will get you the contact information for the person or team in charge of support for your specific industry in your region.

To find the right contact person anywhere in the world, visit:

→ [www.eaton.eu/contact](http://www.eaton.eu/contact)

# Support and Service for UPS Systems and Hydraulic System Solutions

Building a strong relationship with you is of utmost importance to us. This is why you can count on us to quickly get your questions, requests, and suggestions to the relevant specialists. After all, your challenges are our challenges.

## Questions regarding uninterrupted power supplies (UPS)?

Our Technical Service staff will be more than glad to assist you if you are experiencing any difficulties with an Eaton UPS, DC power supply system, or any other Power Quality product.

Our Technical Support staff is there to answer any questions you may have regarding our products.

To find the right contact person anywhere in the world, please visit

[www.eaton.eu/contact](http://www.eaton.eu/contact)

## Questions regarding hydraulic system solutions?

Simply contact our customer service head office in Baden-Baden and our staff will be glad to put you in contact with a local contact person.

### Customer Service:

Eaton Hydraulics Group  
Dr.-Reckeweg-Straße 1  
D-76532 Baden-Baden  
Germany

Phone: +49 (0)7221 682 - 0

Fax: +49 (0)7221 682 - 788

E-mail: [customersupportemea@eaton.com](mailto:customersupportemea@eaton.com)



## Eatons After Sales Service

Eaton is known for its unparalleled after-sales support for all low-voltage switchgear, switchgear systems, and services. For more detailed information, as well as to view our terms and conditions, please visit [www.eaton.eu/aftersales](http://www.eaton.eu/aftersales)

### Europe, Middle East, Africa24/7

#### Hotline

For immediate support please call +49 (0) 180 5 223822\* (24/7). You will receive competent and fast, round the clock assistance, with unplanned machine and system stand stills, system malfunctions and device failures.

(\* 0,14 Euro per minute from the Deutsche Telekom network AG)

#### Helpdesk

Eaton specialists: +49 (0) 228 602 3640 (Monday–Friday from 08:00–16:00 CET) or contact your local Eaton representative.

We offer extensive support from commissioning to application queries as well as in the area of fault analysis, which can also include remote diagnostics.

We can also offer you an individual consulting service contract which is tailor-made to suit your requirements. If you would like to communicate your service queries in writing, please use the following e-mail address:

[AfterSalesEGBonn@eaton.com](mailto:AfterSalesEGBonn@eaton.com)

MGE OFFICE PROTECTION SYSTEMS  
 MCGRAW-EDISON MOELLER  
 METALUX MEM CUTLER-HAMMER  
 COOPER HALO ARROW HART  
 B-LINE BUSSMANN MTL  
 HOLEC MCGRAW-EDISON  
 ARROW HART MEM BUSSMANN  
 METALUX POWERWARE  
 MEM HALO BUSSMANN  
 MCGRAW-EDISON CEAG  
 MOELLER MTL POWERWARE  
 CEAG COOPER BUSSMANN  
 MTL B-LINE  
 HERNIS  
 MCGRAW-EDISON  
 B-LINE  
 ARROW HART  
 MOELLER  
 HALO MEM  
 MTL  
 COOPER  
 HERNIS POWERWARE HOLEC  
 BUSSMANN MTL ARROW HART  
 B-LINE COOPER MCGRAW-EDISON  
 MOELLER CEAG HOLEC MOELLER  
 MTL POWERWARE CEAG  
 MEM MGE OFFICE PROTECTION SYSTEMS  
 HERNIS POWERWARE  
 COOPER HALO CROUSE-HINDS

MORE POSSIBILITIES.  
 POWERFUL SOLUTIONS.

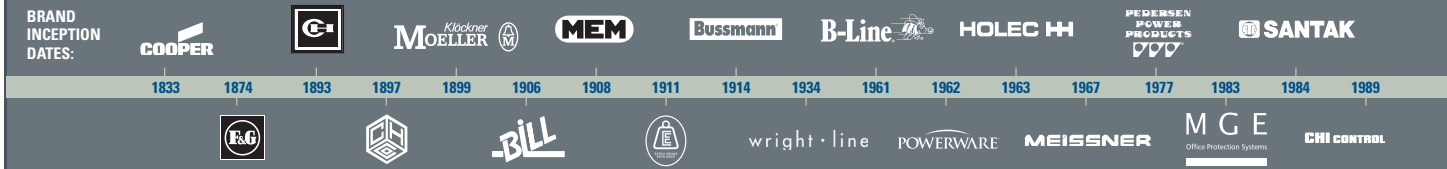

Powering Business Worldwide

Eaton has been serving the power management needs of our customers for more than a century. Over the years, we have expanded our expertise and portfolio of products and services by uniting some of the world's most respected names with Eaton's strong heritage of innovation.

Our goal is simple; to provide unique solutions across a wide range of markets that keep businesses on the leading edge of change. That's the power of One Eaton.



At Eaton, we're energized by the challenge of powering a world that demands more. With over 100 years experience in electrical power management, we have the expertise to see beyond today. From groundbreaking products to turnkey design and engineering services, critical industries around the globe count on Eaton.

We power businesses with reliable, efficient and safe electrical power management solutions. Combined with our personal service, support and bold thinking, we are answering tomorrow's needs today. Follow the charge with Eaton.

Visit [eaton.com/electrical](http://eaton.com/electrical).

Changes to the products, to the information contained in this document, and to prices are reserved; so are errors and omissions. Only order confirmations and technical documentation by Eaton is binding. Photos and pictures also do not warrant a specific layout or functionality. Their use in whatever form is subject to prior approval by Eaton. The same applies to Trademarks (especially Eaton, Moeller, Cutler-Hammer). The Terms and Conditions of Eaton apply, as referenced on Eaton internet pages and Eaton order confirmations.

**Eaton Industries GmbH**

Hein-Moeller-Str. 7-11  
D-53115 Bonn/Germany

© 2014 by Eaton Corporation  
All rights reserved  
Printed in Germany 06/15  
Publication No.: CA04020001Z-EN-INT  
Doku/DHW/ip/MP 05/15  
Article No.: 170504  
(pages 35 and 37 corrected in 12/2015)



Eaton is a registered trademark of Eaton Corporation

All other trademarks are property of their respective owners.

SmartWire-DT® is a registered trademark of Eaton Corporation.



Powering Business Worldwide