

TELEMECANIQUE CONTACTOR SUPPRESSOR

RC, 230VAC/DC

230 V AC/DC

RC

For other configurations and voltages, please inquire

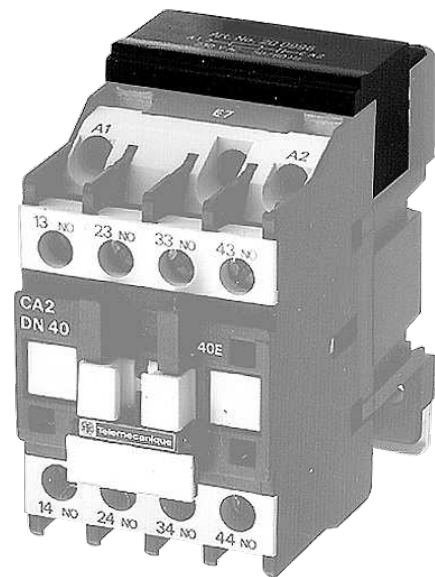
[Link to Product](#)**Illustration**

RC

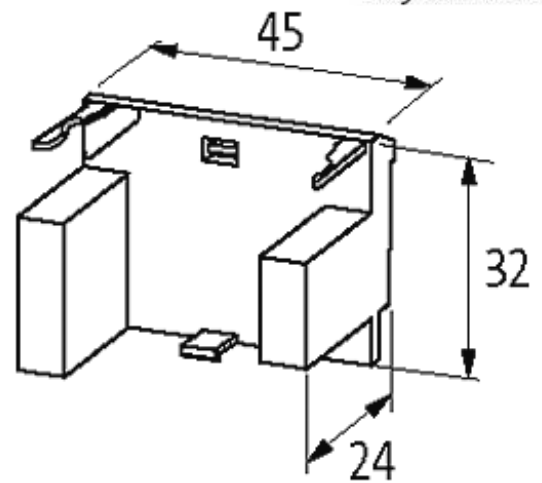
stay connected

Product may differ from Image

Appropriate contactors

CA 2 DN, CA 3 DN, Serie "d", LC 1 D09...D32, LP 1 D0...D32
 NC 1-09(Z)...NC 1-32(Z)

General data

Temperature range -20...+70 °C
 Dimensions H × W × D 24×45×32 mm

Commercial data

country of origin CZ
 customs tariff number 85363010
 minimum order quantity 1