

SIEMENS CONTACTOR SUPPRESSOR

RC, 110VAC/DC

110 V AC/DC

RC

For other configurations and voltages, please inquire

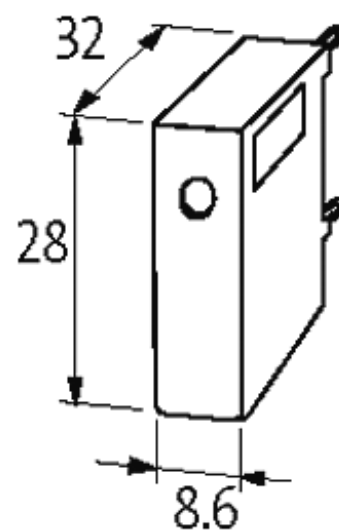
[Link to Product](#)**Illustration**



RC

Product may differ from Image

Approvals



Appropriate contactors

3 RH 1/11; 3 RT 1/3 RH1; 3 RT 1/10.15...10.17

General data

Temperature range -20...+70 °C

Dimensions H x W x D 28x8.6x32 mm

Commercial data

country of origin DE

customs tariff number 85363010

minimum order quantity 1