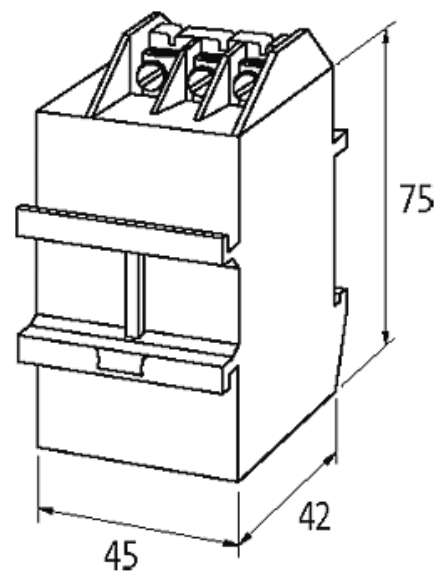

**MOTOR SUPPRESSOR**

RC, 3x400VAC/4kW

3 × 400 V AC  
RC

Suppressors for other voltages, frequencies, and motor ratings available on request. Do not use RC motor suppressors with frequency inverters.

**[Link to Product](#)****Illustration**

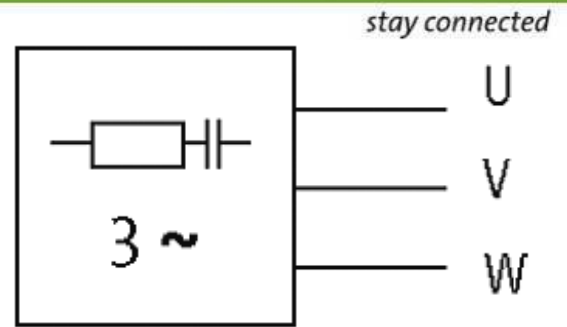

RC

Product may differ from Image

### General data

Connection	3-pole terminal, 2 × 0.75...2.5 mm <sup>2</sup> , M4
Dimensions H × W × D	75×45×42 mm
Temperature range	-20...+60 °C

### Commercial data

country of origin	CZ
customs tariff number	85363010
minimum order quantity	1