

MOTOR SUPPRESSOR

Varistor, 3x575VAC/10kW

3 × 575 V AC
VDR

Suppressors for other voltages, frequencies, and motor ratings available on request. Do not use RC motor suppressors with frequency inverters.

[Link to Product](#)

Illustration

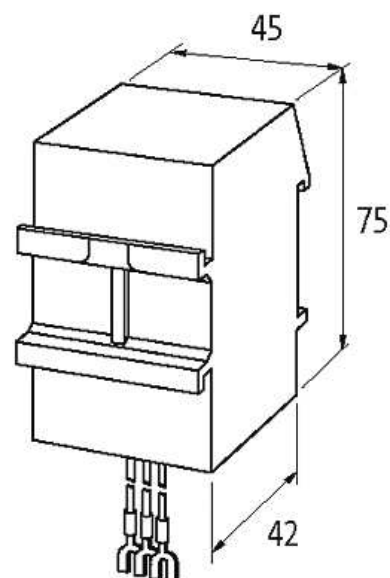

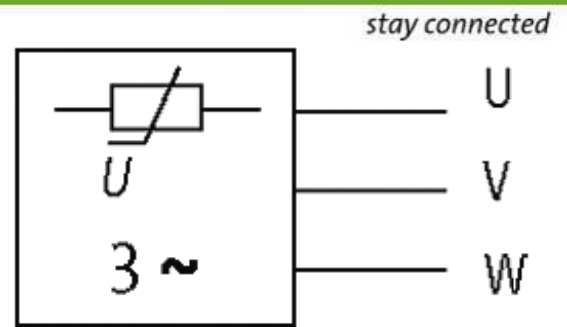

VDR

Product may differ from Image

Approvals



General data

Dimensions H × W × D	75×45×42 mm
Temperature range	-20...+60 °C
Connection	approx. 250 mm, single cores 0.5 mm ² , with self-securing fork terminal ends M4

Technical Data

Frequency	10...400 Hz
-----------	-------------

Commercial data

country of origin	CZ
customs tariff number	85363010
minimum order quantity	1