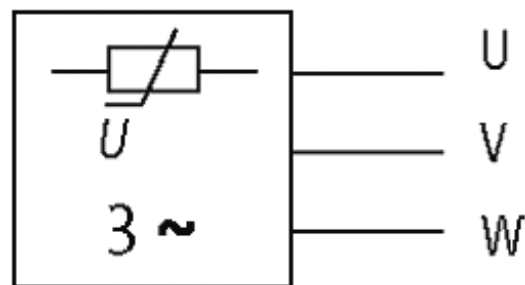

MOTOR SUPPRESSOR

Varistor, 3x575VAC/20kW

3 × 575 V AC
VDR

Suppressors for other voltages, frequencies, and motor ratings available on request. Do not use RC motor suppressors with frequency inverters.

[Link to Product](#)**Illustration**

VDR

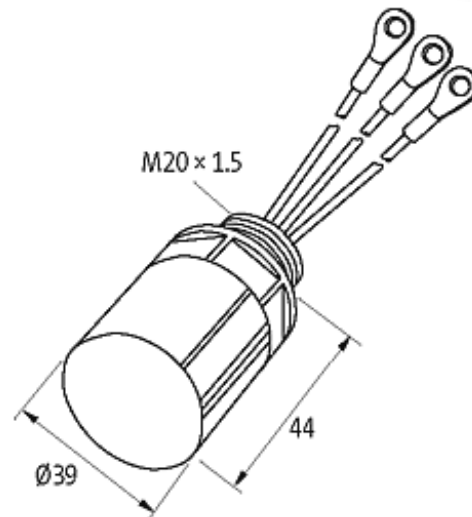
stay connected

Product may differ from Image

Approvals



General data

Connection	approx. 150 mm, single cores 1 mm ²
Temperature range	-20...+60 °C
Mounting method	on motor terminal box with plug connector
Dimensions H × W × D	39×39×44 mm

Technical Data

Frequency	10...400 Hz
-----------	-------------

Commercial data

country of origin	CZ
customs tariff number	85363010
minimum order quantity	1