

UNIVERSAL CONTACTOR SUPPRESSOR

Varistor, 24VAC/DC

24 V AC/DC
VDR

For other configurations and voltages, please inquire

[Link to Product](#)

Illustration



VDR

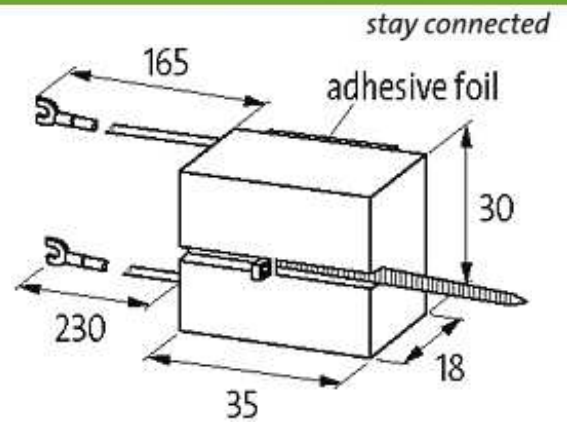

Product may differ from Image

Approvals



Appropriate contactors

universal

General data

Temperature range	-20...+70 °C
Dimensions H × W × D	35×30×18 mm

Technical Data

Max. power (W)	200 W(VA)
----------------	-----------

Commercial data

country of origin	CZ
customs tariff number	85363010
minimum order quantity	1