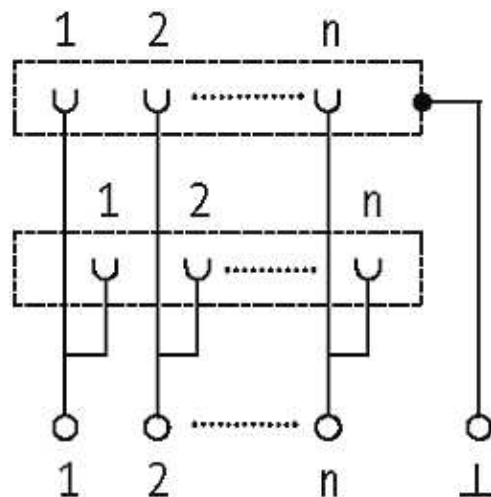
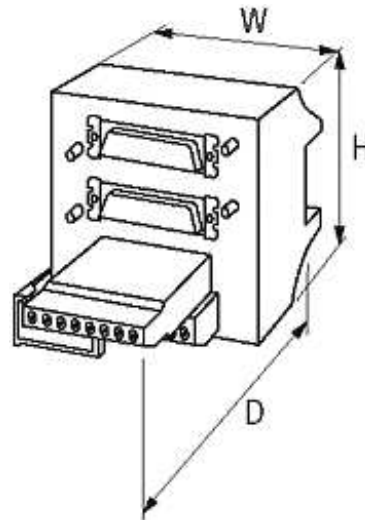

SV-2 X SUB D 25 -KL. FOR SIGNAL TRANSFER

125 VAC/DC / 2 A

Female connector
25-pole
Screw terminals[Link to Product](#)**Illustration**

Picture: female

stay connected

Product may differ from Image

General data

Mounting method	DIN-rail mountable (EN 60715)
Temperature range	-20...+70 °C
Dimensions H × W × D	75×90×66 mm

Technical Data

Locking of ports	Standard UNC 4-40 screw thread bolt (EN 60807)
------------------	--

Commercial data

country of origin	CZ
customs tariff number	85369010
minimum order quantity	1