

MTS 1-PHASE CONTROL AND ISOLATION TRANSFORMER

P: 63VA IN: 208...550VAC OUT: 2x115VAC

Single-phase - Control and Isolation Transformers
63 VA
Isolation class T 40/B

Other voltages on request.

[Link to Product](#)

Illustration

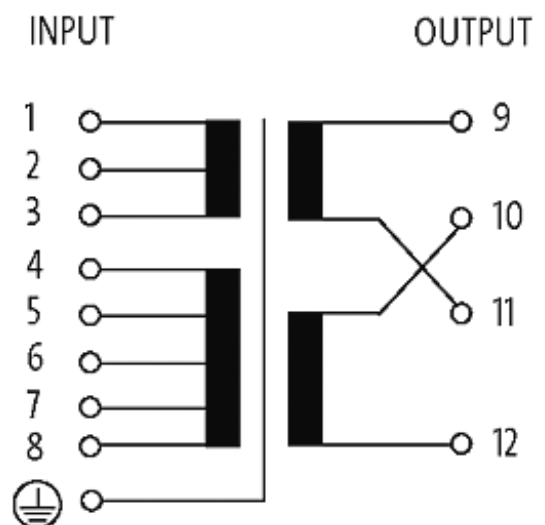

stay connected

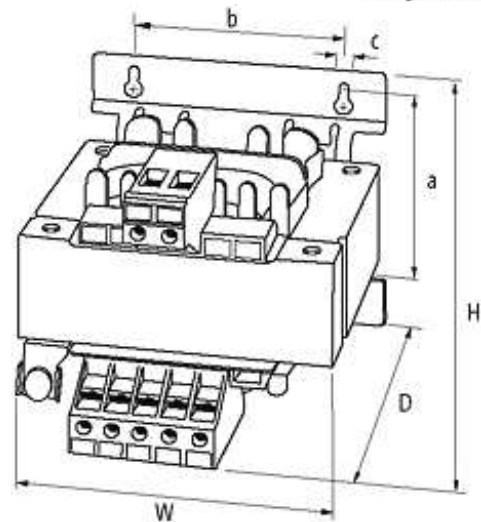

Product may differ from Image

Approvals



Input

Input voltage	208, 230, 380, 400, 420, 440, 460, 480, 500, 525, 550 V AC
Input current	0.37 A (208 V AC); 0.14 A (550 V AC)
Inrush current	5.2 A (208 V AC); 2.0 A (550 V AC)
Short-circuit current	3.6 A (208 V AC); 1.4 A (550 V AC)
Frequency	50...60 Hz

General data

Standards	EN 61558-1, EN 61558-2-4, EN 62041 category 0
Test isolation voltage	4 kV (prim./sec.)
Mounting method	Long-hole mounting or DIN-rail mountable TH35 (EN 60715)
Dimensions H × W × D	97×78×93 mm
Fixing centers a × b × c	56×56 mm
Drill hole Ø	4.8×8.4 mm
Temperature range	-20...+40 °C, no condensation

Output

Output voltage	1 × 230, 1 × 115, 2 × 115 V AC
----------------	--------------------------------

Commercial data

country of origin	CZ
customs tariff number	85043180
minimum order quantity	1