

MST 1-PHASE CONTROL AND ISOLATION TRANSFORMER

P: 1000VA IN: 208...550VAC OUT: 2x115VAC

Single-phase - Control and Isolation Transformers
1000 VA
Isolation class T 40/B

Other voltages on request.

[Link to Product](#)

Illustration

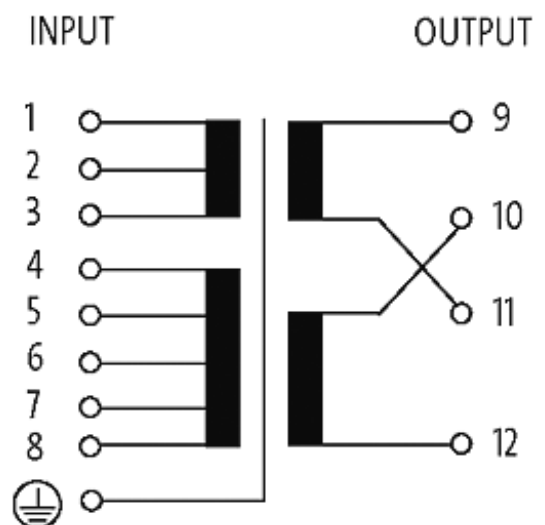

stay connected

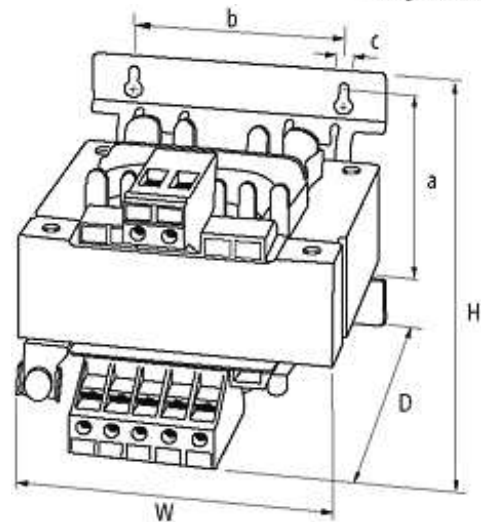

Product may differ from Image

Approvals



Input

Input voltage	208, 230, 380, 400, 420, 440, 460, 480, 500, 525, 550 V AC
Input current	4.73 A (230 V AC); 2.72 A (400 V AC)
Inrush current	66 A (230 V AC); 38 A (400 V AC)
Short-circuit current	148 A (230 V AC); 85 A (400 V AC)
Frequency	50...60 Hz

General data

Standards	EN 61558-1, EN 61558-2-4, EN 62041 category 0
Test isolation voltage	4 kV (prim./sec.)
Mounting method	Key-hole mounting
Dimensions H × W × D	128×174×160 mm
Fixing centers a × b × c	102×135×7 mm
Drill hole Ø	7×11 mm
Temperature range	-20...+40 °C, no condensation

Output

Output voltage	1 × 230, 1 × 115, 2 × 115 V AC
----------------	--------------------------------

Commercial data

country of origin	CZ
customs tariff number	85043180
minimum order quantity	1