

MTS 1-PHASE SAFETY TRANSFORMER

P: 100VA IN: 230/400VAC +/- 15VAC OUT: 24VAC

Single-phase safety transformer
100 VA
Isolation class T 40/B

Other voltages on request.

[Link to Product](#)

Illustration

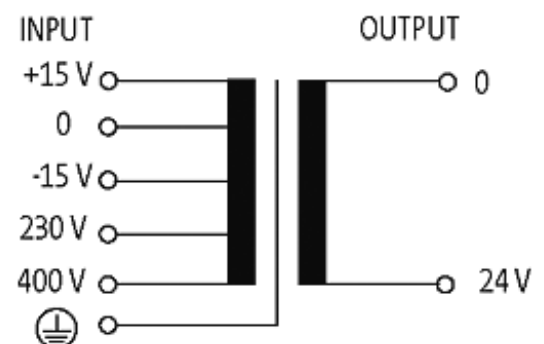

stay connected

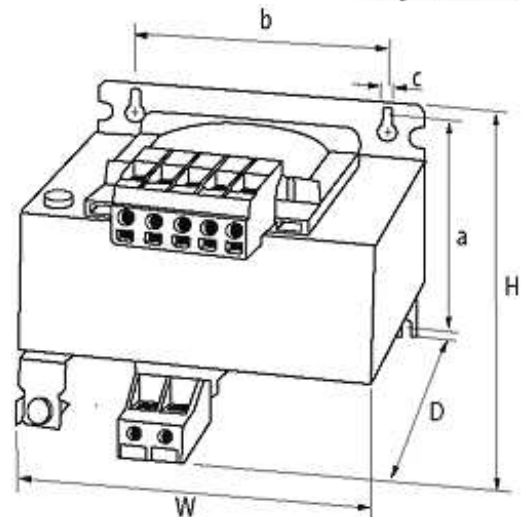

Product may differ from Image

Approvals



Input

Input voltage	230/400 ±15 V AC
Frequency	50...60 Hz
Input current	0.5 A (230 V AC); 0.3 A (400 V AC)
Inrush current	4.1 A (230 V AC); 2.3 A (400 V AC)
Short-circuit current	6.6 A (230 V AC); 3.8 A (400 V AC)

General data

Standards	EN 61558-1, EN 61558-2-6, EN 62041 category 0
Test isolation voltage	4 kV (prim./sec.)
Mounting method	Long-hole mounting or DIN-rail mountable TH35 (EN 60715)
Temperature range	-20...+40 °C, no condensation
Dimensions H × W × D	86×84×98 mm
Fixing centers a × b × c	64.5×64×4.8 mm
Drill hole Ø	4.8×8.4 mm

Output

Output voltage	24 V AC (SELV)
----------------	----------------

Commercial data

country of origin	CZ
customs tariff number	85043180
minimum order quantity	1