

MTL 1-PHASE SAFETY TRANSFORMER

P: 63VA IN: 230/400VAC +/- 15VAC OUT: 2x24VAC

63 VA

Isolation class T 60/B

[Link to Product](#)

Illustration

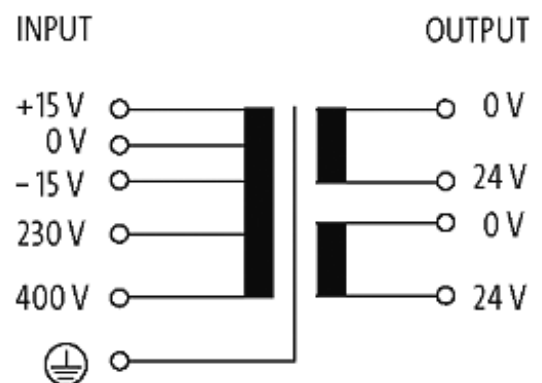

stay connected

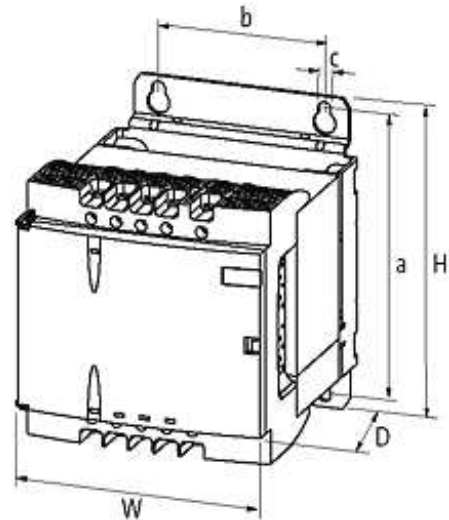

Product may differ from Image

Approvals



Input

Input voltage	230/400 ±15 V AC
Input current	0.4 A (230 V AC); 0.23 A (400 V AC)
Inrush current	5.34 A (230 V AC); 3.08 A (400 V AC)
Short-circuit current	6.53 A (230 V AC); 3.77 A (400 V AC)
Frequency	50...60 Hz

General data

Test isolation voltage	5.1 kV (prim./sec.)
Standards	EN 61558-2-4, EN 61558-2-6, EN 62041 category 0
Drill hole Ø	5.5×9 mm
Fixing centers a × b × c	96×60×5.5 mm
Mounting method	DIN-rail mountable TH35-15 (EN 60715) or for key-hole mounting
Dimensions H × W × D	108×87×116 mm
Temperature range	-20...+60 °C, no condensation

Technical Data

LED display	LED (green) for input voltage
-------------	-------------------------------

Output

Output voltage	1 × 24, 1 × 48, 2 × 24 V AC
----------------	-----------------------------

Commercial data

country of origin	CZ
customs tariff number	85043180
minimum order quantity	1

