

MCS POWER SUPPLY 3-PHASE,

IN: 360-550VAC OUT: 24-28V/5ADC

INPUT: 3 × 360...550 V AC

OUTPUT: 24...28 V DC

Current: 5 A

[Link to Product](#)

Illustration

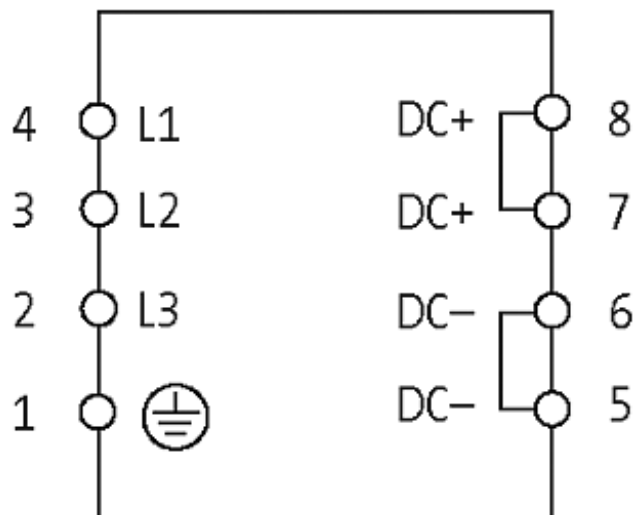

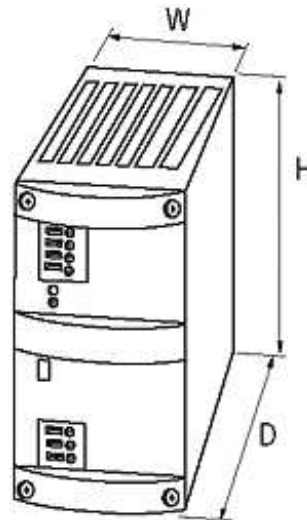

Product may differ from Image

Approvals



Input

Input voltage	3 × 360...550 V AC
Input current	3 × 0.33 A
Inrush current after 1 ms	max. 15 A
Primary fusing external	max. 3 × 2 A
Frequency	50...60 Hz

General data

Standards	EN 60950-1, EN 61204-3, EN 55022 B
Relative humidity	5...95 %, no condensation
Efficiency	90 %
Dimensions H × W × D	127×68×198 mm
Mounting method	DIN-rail mountable TH35 (EN 60715)
Temperature range	0...+60 °C (storage temperature -25...+85 °C)

Output

Output voltage	24 V DC (SELV), ±1 %; 24...28 V adjustable
Output current	5 A (+60 °C); 6 A (+40 °C)
Mains failure bridging time	min. 25 ms (400 V AC)
Ripple	max. 20 mVrms
Unit protection	short-circuit and overload protected
Spikes	max. 100 mV p-p
LED display	LED (green) for output voltage
Selectable switch-off mode	front sided plug link (automatic re-start or definite shut-off)

Parallel usage/serial usage max. 5 units/max. 2 units

Commercial data

country of origin	CZ
customs tariff number	85044090
minimum order quantity	1