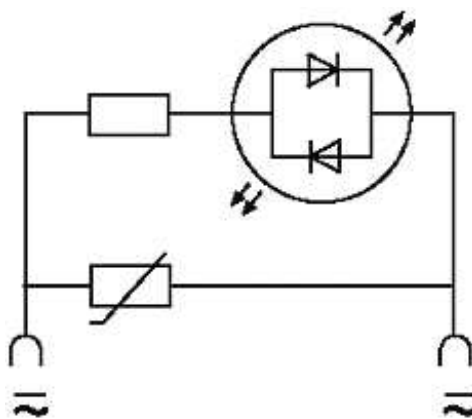

VALVE PLUG SUPPRESSOR FORM A - 18MM

Varistor and LED, 48VAC/DC/100VA/W

48 V AC/DC
VDR + LED

Remove plug gasket when fitting adapter. Other LED colors on request.

[Link to Product](#)**Illustration**

LED + VDR

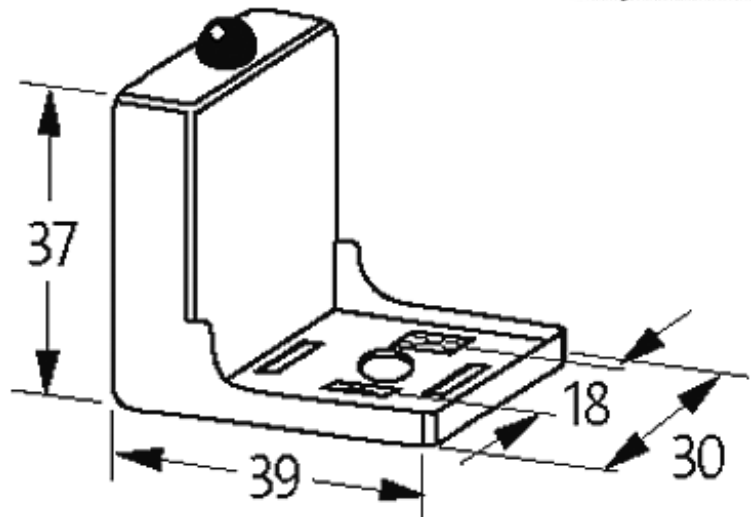

Product may differ from Image

General data

Housing	Polyamide black, flame retardant, temperature resistance up to 130 °C
Temperature range	-20...+60 °C
Contact material	Silvered bronze
Dimensions H × W × D	37×39×30 mm

Technical Data

Switch off peak	max. 75 V
Switch off delay time	max. 10 ms
Max. power (W)	max. 100 W(VA)

Commercial data

country of origin	CZ
customs tariff number	85363010
minimum order quantity	1