

VALVE PLUG SUPPRESSOR FORM A - 18MM

RC and LED, 230VAC/DC/25VA/W

230 V AC/DC

RC + LED

Remove plug gasket when fitting adapter. Other LED colors on request.

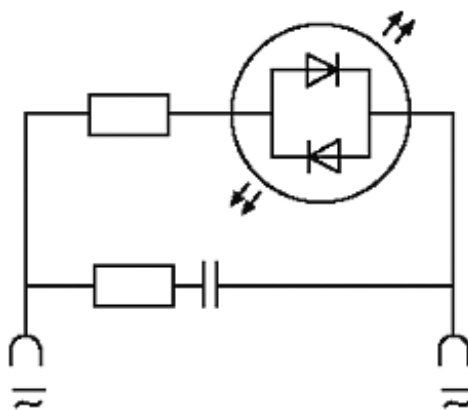
[Link to Product](#)**Illustration**

LED + RC

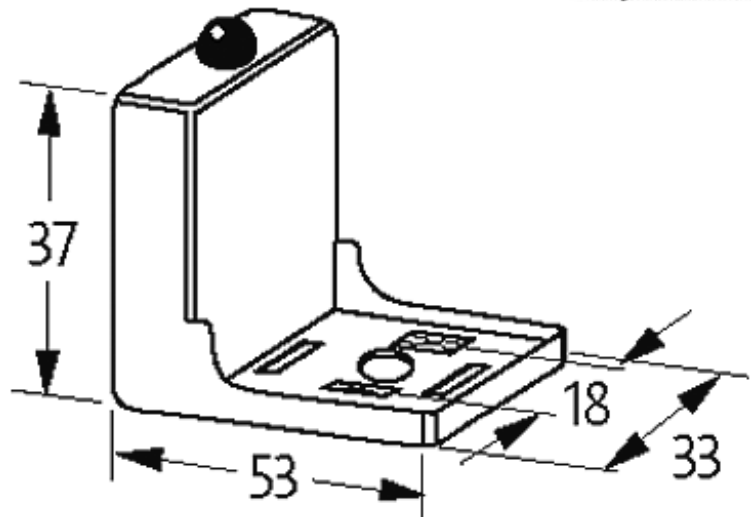

Product may differ from Image

General data

Housing	Polyamide black, flame retardant, temperature resistance up to 130 °C
Temperature range	-20...+60 °C
Contact material	Silvered bronze
Dimensions H × W × D	37×53×33 mm

Technical Data

Switch off peak	max. 300 V
Switch off delay time	max. 20 ms
Max. power (W)	max. 25 W(VA)

Commercial data

country of origin	CZ
customs tariff number	85363010
minimum order quantity	1