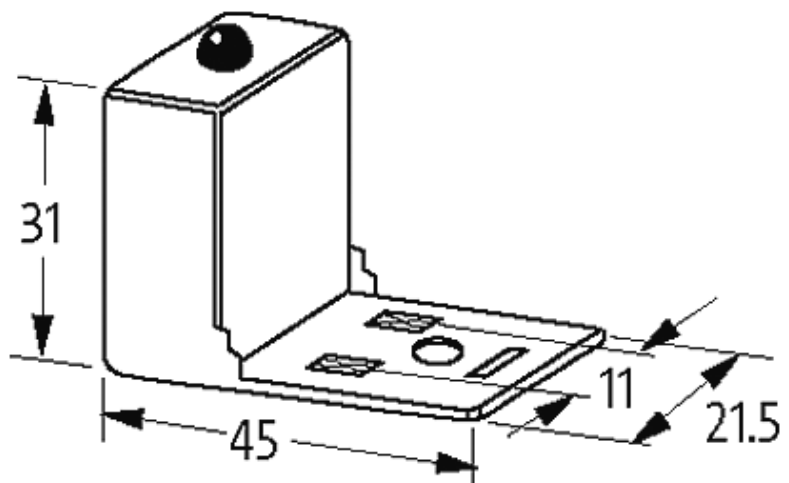

VALVE PLUG SUPPRESSOR FORM BI - 11MM

RC and LED, 24VAC/DC/20VA/W

24 V AC/DC
RC + LED

Remove plug gasket when fitting adapter. Other LED colors on request. Note PIN arrangement (PE at cable outlet of connector). 180° turned version on request.

[Link to Product](#)**Illustration**

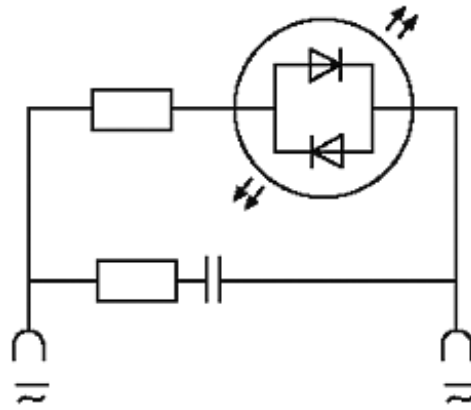

LED + RC

Product may differ from Image

General data

Housing	Polyamide black, flame retardant, temperature resistance up to 130 °C
Temperature range	-20...+60 °C
Contact material	Silvered bronze
Dimensions H × W × D	31×45×21.5 mm

Technical Data

Switch off delay time	max. 20 ms
Switch off peak	max. 70 V
Max. power (W)	max. 20 W(VA)

Commercial data

country of origin	CZ
customs tariff number	85363010
minimum order quantity	1