

## ROCKWELL ALLEN-BRADLEY CONTACTOR SUPPRESSOR

Varistor, 110VAC/DC

110 V AC/DC

VDR

For other configurations and voltages, please inquire

[Link to Product](#)

### Illustration

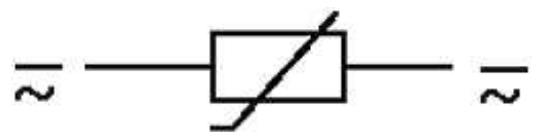

VDR

stay connected

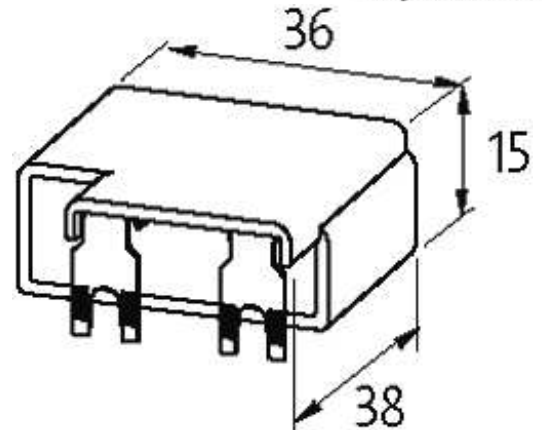

Product may differ from Image

### Approvals



### Appropriate contactors

100-C09...C85

### General data

Dimensions H × W × D	15×36×38 mm
Temperature range	-20...+70 °C

### Technical Data

Damping factor	approx. 1.5 × UN
Material	Flame retardant plastic acc. to (UL 94)
Connection wires	Plug contact

### Commercial data

country of origin	CZ
customs tariff number	85363010
minimum order quantity	1