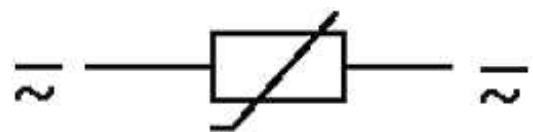

SIEMENS CONTACTOR SUPPRESSOR

Varistor, 230VAC/DC

230 V AC/DC
VDR

For other configurations and voltages, please inquire

[Link to Product](#)**Illustration**

VDR

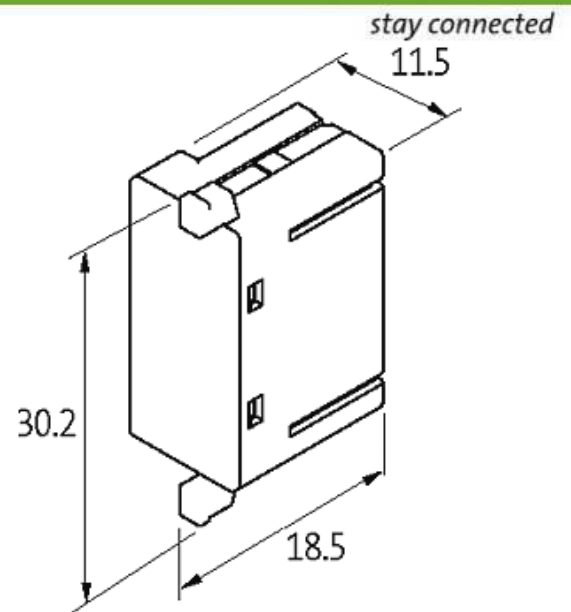

Product may differ from Image

Approvals



Appropriate contactors

3 RT 20.25/26/27/28

General data

Dimensions H × W × D	18.5×30.2×11.5 mm
Temperature range	-20...+70 °C

Technical Data

Damping factor	approx. 1.5 × UN
Material	Flame retardant plastic acc. to (UL 94)
Connection wires	Plug contact

Commercial data

country of origin	CZ
customs tariff number	85363010
minimum order quantity	1