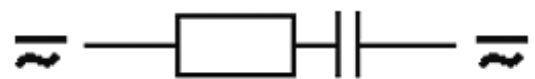

SIEMENS CONTACTOR SUPPRESSOR

RC, 230VAC/DC

230 V AC/DC
RC

For other configurations and voltages, please inquire

[Link to Product](#)**Illustration**

RC

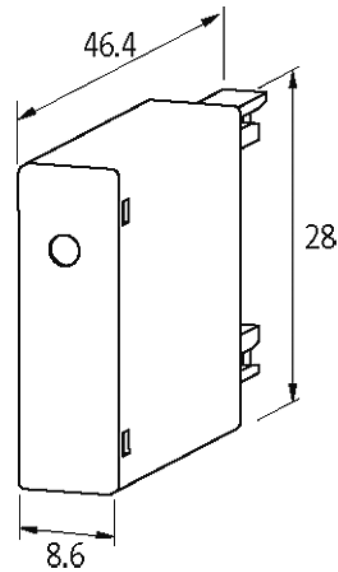
stay connected

Product may differ from Image

Approvals



Appropriate contactors

3 RT 20.15/16/17/18

General data

Dimensions H × W × D	46.4×28×8.6 mm
Temperature range	-20...+70 °C

Technical Data

Damping factor	approx. 1.5 × UN
Material	Flame retardant plastic acc. to (UL 94)
Connection wires	Plug contact

Commercial data

country of origin	CZ
customs tariff number	85363010
minimum order quantity	1