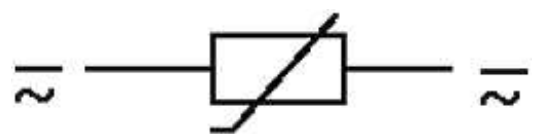

TELEMECANIQUE CONTACTOR SUPPRESSOR

Varistor, 110VAC/DC

110 V AC/DC
VDR

For other configurations and voltages, please inquire

[Link to Product](#)**Illustration**

VDR

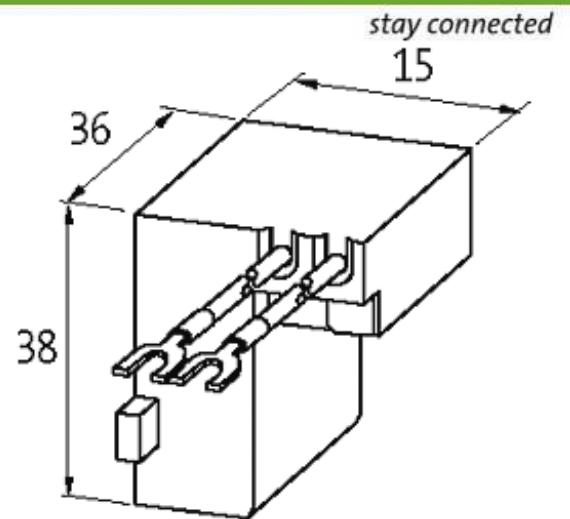

Product may differ from Image

Approvals



Appropriate contactors

LC 1 D09...D38, LC 1 DT20, DT40, LC 2 D09...D38

General data

Dimensions H × W × D	15×36×38 mm
Temperature range	-20...+70 °C

Technical Data

Damping factor	approx. 1.5 × UN
Material	Flame retardant plastic acc. to (UL 94)
Connection wires	self-securing cable forks

Commercial data

country of origin	CZ
customs tariff number	85363010
minimum order quantity	1