

M12 FEMALE 90° LED

PVC 3X0.34 black UL/CSA 5m

M12

Female 90°

3-pole with 2 × LED (PNP)

Art.-No. 7005 - M12 Lite - (plastic hexagonal screw) on request

Plastic housings with good resistance against chemicals and oils. The resistance to aggressive media should be individually tested for your application. Further details on request. Further cable lengths on request.

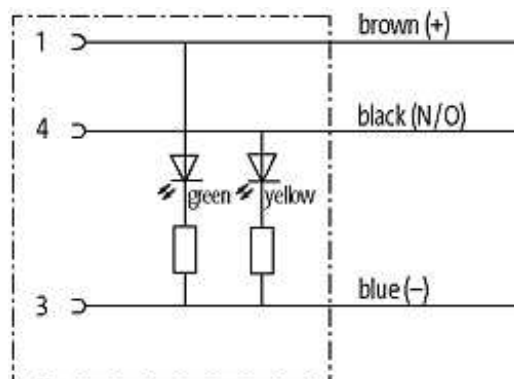
[Link to Product](#)**Illustration**

Female

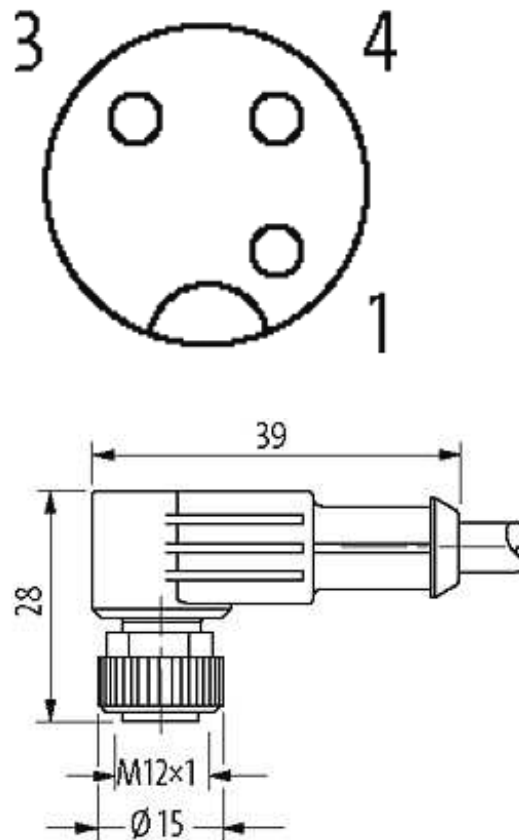

Product may differ from Image

Approvals

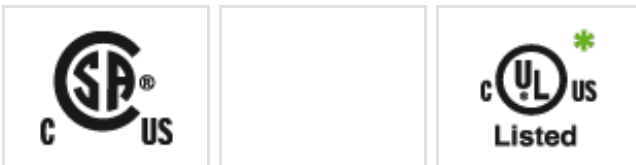

Form

Form 12381

Cables

Cable number	613
No./diameter of wires	3 × 0.34 mm ²
Wire isolation	PVC (br, bl, bk)
Jacket Color	black
Shore hardness outer jacket	85 ± 5A
Material (jacket)	PVC (UL/CSA)
Outer Ø	approx. 4.6 mm
Bend radius (fixed)	5 × outer Ø
Bend radius (moving)	10 × outer Ø

The information in this brochure has been compiled with the utmost care.

Liability for the correctness completeness and topicality of the information is restricted to gross negligence. Version: 05/16

Temperature range (fixed)	-30...+80 °C
---------------------------	--------------

Temperature range (mobile)	-5...+80 °C
----------------------------	-------------

General data

Temperature range	-25...+85 °C, depending on cable quality
-------------------	--

Technical Data

Operating voltage	24 V DC \pm 25 %
-------------------	--------------------

Operating current per contact	max. 4 A
-------------------------------	----------

Coding	M12, A-coded
--------	--------------

LED display	LED (green): Power / LED (yellow): (S1)
-------------	---

Locking of ports	Screw thread M12 \times 1 mm (recommended torque 0.6 Nm) self-securing
------------------	--

Compression gland	M12 (SW13)
-------------------	------------

Protection	IP66K, IP67 inserted and tightened (EN 60529)
------------	---

Locking material	Zinc die casting, matte nickel plated
------------------	---------------------------------------

Material	PUR
----------	-----

Commercial data

country of origin	DE
-------------------	----

customs tariff number	85444290
-----------------------	----------

minimum order quantity	1
------------------------	---