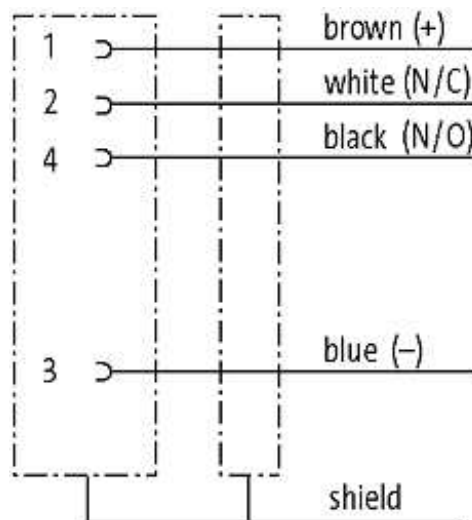

M12 FEMALE 90° SHIELDED

PUR 4X0.34 shielded black UL/CSA, drag ch 5m

M12
Female 90°
4-pole, shielded

Plastic housings with good resistance against chemicals and oils. The resistance to aggressive media should be individually tested for your application. Further details on request. Further cable lengths on request.

[Link to Product](#)**Illustration**

Female

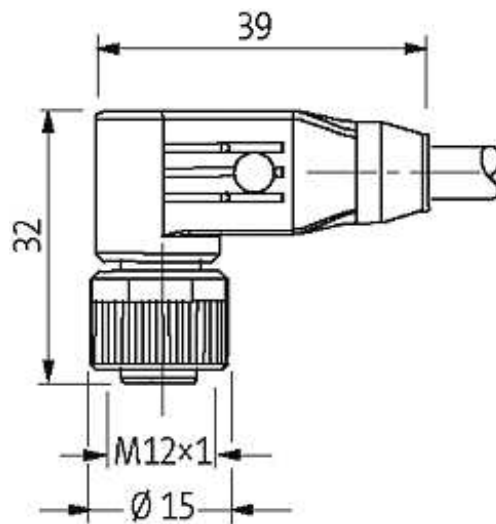

Product may differ from Image

Approvals



* only for products with UL/CSA approved cable

Form

Form 13261

Cables

Cable number	641
No./diameter of wires	4 × 0.34 mm ²
Wire isolation	PP (br, wh, bl, bk)
C-track properties	5 Mio.
Torsion	2 Mio. ± 30°/m

Jacket Color	black
Shore hardness outer jacket	90 ± 5A
Material (jacket)	PUR (UL/CSA)
Outer Ø	approx. 5.3 mm
Bend radius (fixed)	5 × outer Ø
Bend radius (moving)	10 × outer Ø
Temperature range (fixed)	-40...+80 °C
Temperature range (mobile)	-25...+80 °C
Shielded	yes

General data

Temperature range	-25...+85 °C, depending on cable quality
-------------------	--

Technical Data

Operating voltage	max. 60 V AC/DC
Operating voltage (only UL listed)	max. 30 V AC/DC
Operating current per contact	max. 4 A
Locking of ports	Screw thread M12 × 1 mm (recommended torque 0.6 Nm) self-securing
Locking material	Zinc die casting, matte nickel plated
Protection	IP66K, IP67 inserted and tightened (EN 60529)

Commercial data

country of origin	DE
customs tariff number	85444290
minimum order quantity	1