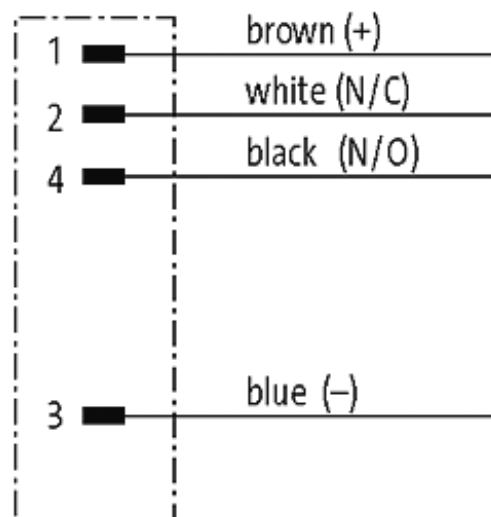

M12 male receptacle A-cod. front mount incl. nut

wires PP 4x0,34 0,5m

Flange M12 male
4-pole
Front mounting
Mounting nut
with multi-strand wire

Further cable lengths on request. The resistance to aggressive media should be individually tested for your application. Further details on request.

[Link to Product](#)**Illustration**

Male

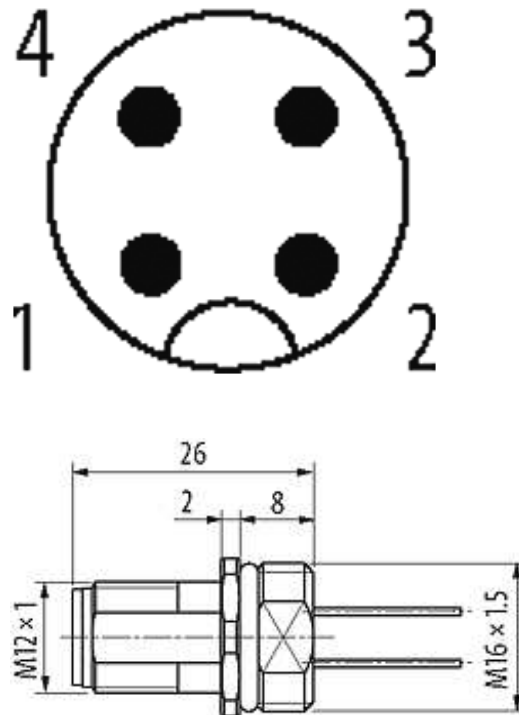

Product may differ from Image

Form

Form 13502

Cables

Cable number	971
No./diameter of wires	4 × 0.34 mm ²
Wire isolation	PP (br, wh, bl, bk)
Shore hardness outer jacket	70 ± 5D
Outer Ø	approx. 1.25 mm
Bend radius (fixed)	5 × outer Ø
Bend radius (moving)	10 × outer Ø
Temperature range (fixed)	-40...+80 °C
Temperature range (mobile)	-25...+80 °C

Technical Data

Operating voltage	max. 250 V AC/DC
Operating current per contact	max. 4 A
Locking of ports	Screw thread M12 × 1 mm (recommended torque 0.6 Nm) self-securing
Protection	IP66K, IP67 inserted and tightened (EN 60529)

Commercial data

country of origin	DE
customs tariff number	85444290
minimum order quantity	1