

**M12 male receptacle A-cod. rear mount**

PP-wires 4X0.34 1.0m

Flange M12 male

4-pole

Rear mounting

Mounting nut

with multi-strand wire

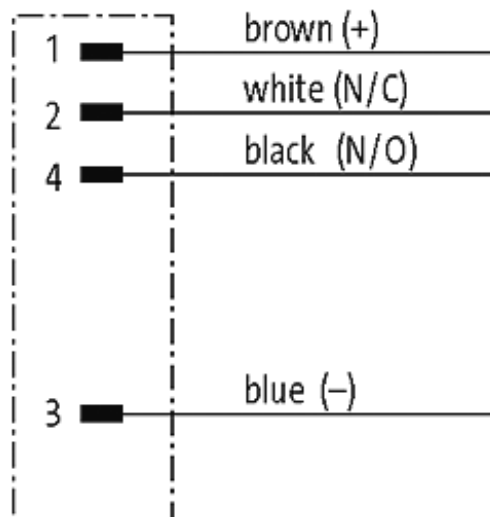
**[Link to Product](#)****Illustration**

# Male

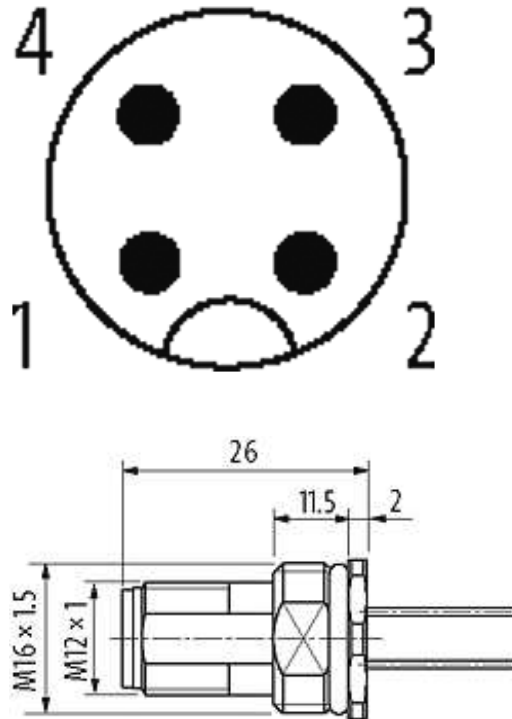

Product may differ from Image

## Form

Form 13505

## Cables

Cable number	971
No./diameter of wires	4 × 0.34 mm <sup>2</sup>
Wire isolation	PP (br, wh, bl, bk)
Shore hardness outer jacket	70 ± 5D
Outer Ø	approx. 1.25 mm
Bend radius (fixed)	5 × outer Ø
Bend radius (moving)	10 × outer Ø
Temperature range (fixed)	-40...+80 °C
Temperature range (mobile)	-25...+80 °C

## General data

Temperature range -25...+85 °C

## Technical Data

Operating voltage	max. 250 V AC/DC
Operating current per contact	max. 4 A
Locking of ports	Screw thread M12 × 1 mm (recommended torque 0.6 Nm) self-securing

Protection	IP66K, IP67 inserted and tightened (EN 60529)
------------	---

Material	CuZn, nickel plated
----------	---------------------

**Commercial data**

country of origin	DE
-------------------	----

customs tariff number	85444290
-----------------------	----------

minimum order quantity	1
------------------------	---