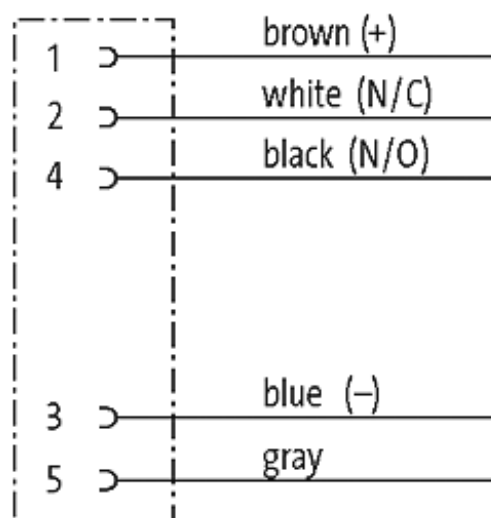

M12 female receptacle A-cod. rear mount

PP-wires 5X0.34 1.0m

Flange M12 female
5-pole
Rear mounting
Mounting nut
with multi-strand wire

[Link to Product](#)**Illustration**

Female

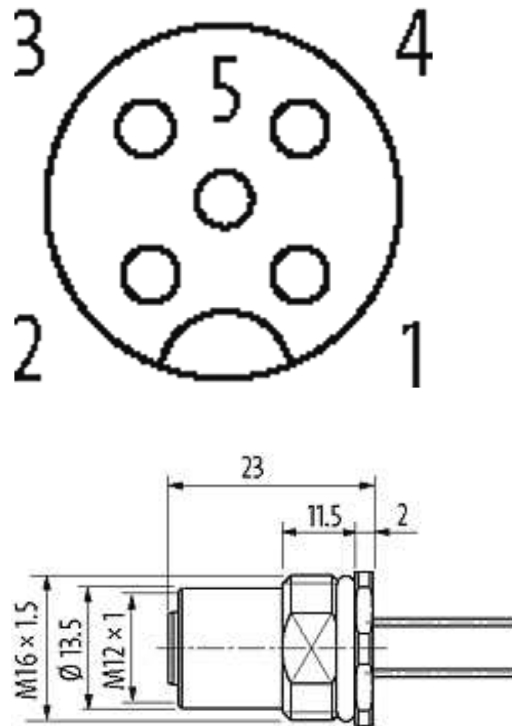

Product may differ from Image

Form

Form 13565

Cables

Cable number	972
No./diameter of wires	5 × 0.34 mm ²
Wire isolation	PP (br, wh, bl, bk, gr)
Shore hardness outer jacket	70 ± 5D
Outer Ø	approx. 1.25 mm
Bend radius (fixed)	5 × outer Ø
Bend radius (moving)	10 × outer Ø
Temperature range (fixed)	-40...+80 °C
Temperature range (mobile)	-25...+80 °C

General data

Temperature range -25...+85 °C

Technical Data

Operating voltage	max. 125 V AC/DC
Operating current per contact	max. 4 A
Locking of ports	Screw thread M12 × 1 mm (recommended torque 0.6 Nm) self-securing

Protection	IP66K, IP67 inserted and tightened (EN 60529)
------------	---

Material	CuZn, nickel plated
----------	---------------------

Commercial data

country of origin	DE
-------------------	----

customs tariff number	85444290
-----------------------	----------

minimum order quantity	1
------------------------	---