

M12 female recept. Y-cod. shielded RM Ethernet

PUR 4xAWG20+1x4xAWG26 shielded bk 2m

Ethernet CAT5
Flange M12 female
8-pole, shielded

Further cable lengths on request. Plastic housings with good resistance against chemicals and oils. The resistance to aggressive media should be individually tested for your application. Further details on request.

[Link to Product](#)

Illustration

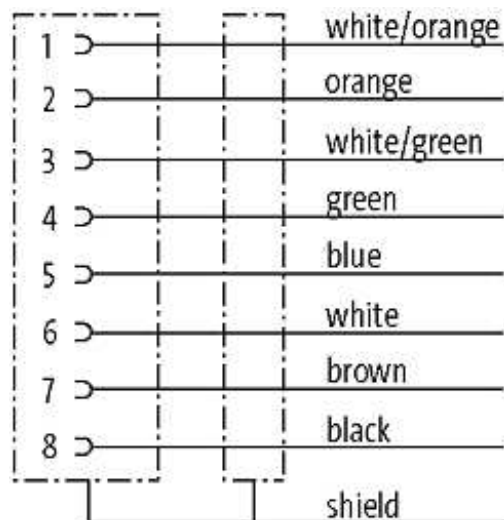

Female

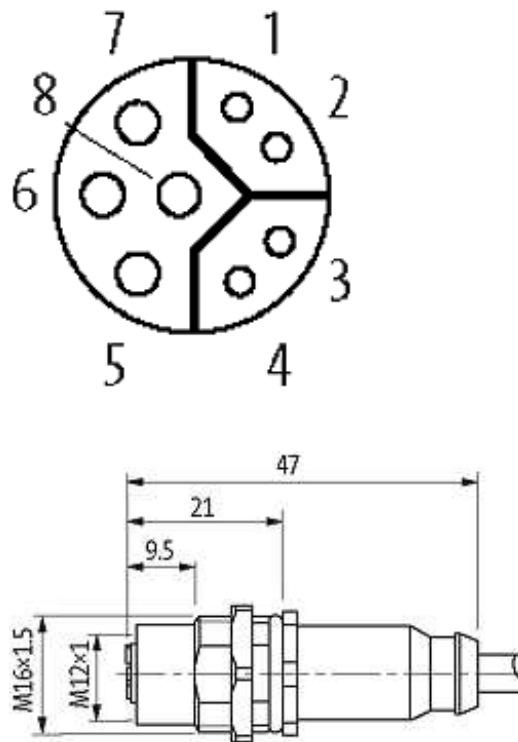

Product may differ from Image

Form

Form 15671

Cables

Cable number	805
No./diameter of wires	4×0.6 mm ² + 1×(4×0.15 mm ²)
Wire isolation	PP (whor, or, whgn, gn, bk, br, wh, bl)
C-track properties	5 Mio.
Torsion	2 Mio. ± 30°/m
Jacket Color	black
Shore hardness outer jacket	90 ± 5A
Material (jacket)	PUR (UL/CSA)
Outer Ø	approx. 8.1 mm
Bend radius (fixed)	5 × outer Ø
Bend radius (moving)	10 × outer Ø
Temperature range (fixed)	-50...+80 °C
Temperature range (mobile)	-40...+80 °C
Shielded	yes

Technical Data

Operating voltage	30 V DC
Operating current per contact	max. 0.5 A/max. 6 A

Locking of ports	Screw thread M12 × 1 mm (recommended torque 0.6 Nm) self-securing
Transfer parameters	CAT5, class D (ISO/IEC 11801:2002), (EN 50173-1)
Transfer rate	10/100 Mbit/s full duplex
Protection	IP66K, IP67 inserted and tightened (EN 60529)
Material	CuZn, nickel plated

Commercial data

country of origin	DE
customs tariff number	85444290
minimum order quantity	1