

M12 male receptacle A-cod. front mount incl. nut

wires 8x0.25 0,2m

Flange M12 male
8-pole
Front mounting
Mounting nut
with multi-strand wire

[Link to Product](#)**Illustration**

1	white
2	brown
3	green
4	yellow
5	gray
6	pink
7	blue
8	red

Male

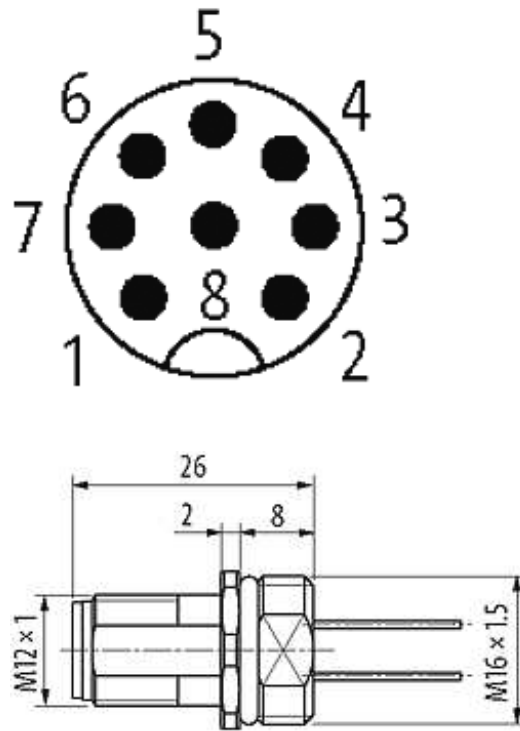

Product may differ from Image

Form

Form 17162

Cables

Cable number	973
No./diameter of wires	8 × 0.25 mm ²
Wire isolation	PP (wh, br, gn, ye, gr, pk, bl, rd)
C-track properties	2 Mio.
Shore hardness outer jacket	75 ± 5A
Outer Ø	approx. 1.25 mm
Bend radius (fixed)	10 × outer Ø
Bend radius (moving)	15 × outer Ø
Temperature range (fixed)	-40...+80 °C
Temperature range (mobile)	-20...+80 °C

Technical Data

Operating voltage	max. 60 V AC/DC
Operating current per contact	max. 2 A
Locking of ports	Screw thread M12 × 1 mm (recommended torque 0.6 Nm) self-securing
Protection	IP66K, IP67 inserted and tightened (EN 60529)

Commercial data

country of origin	DE
customs tariff number	85444290
minimum order quantity	1