

M12 MALE FLANGE PLUG A CODED REAR MOUNT

PP-wires 8x0,25 1.0m

Flange M12 male
8-pole
Rear mounting
Mounting nut
with multi-strand wire

[Link to Product](#)**Illustration**

1	white
2	brown
3	green
4	yellow
5	gray
6	pink
7	blue
8	red

Male

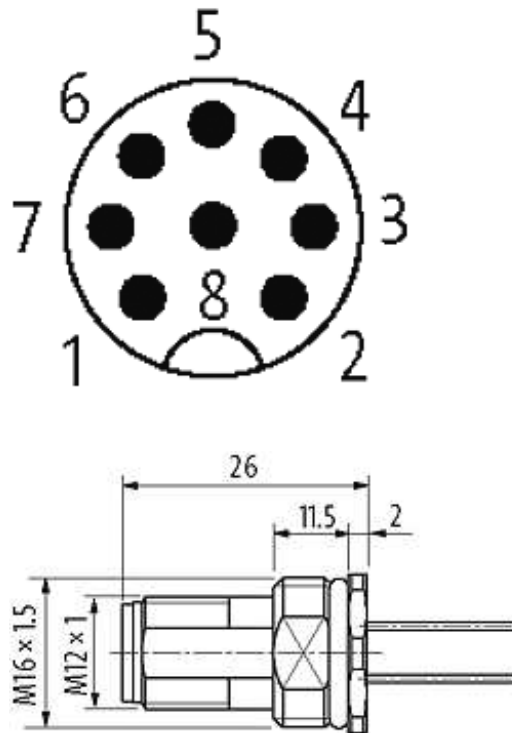

Product may differ from Image

Form

Form 17165

Cables

Cable number	973
No./diameter of wires	8 × 0.25 mm ²
Wire isolation	PP (wh, br, gn, ye, gr, pk, bl, rd)
C-track properties	2 Mio.
Shore hardness outer jacket	75 ± 5A
Outer Ø	approx. 1.25 mm
Bend radius (fixed)	10 × outer Ø
Bend radius (moving)	15 × outer Ø
Temperature range (fixed)	-40...+80 °C
Temperature range (mobile)	-20...+80 °C

General data

Temperature range -25...+85 °C

Technical Data

Operating voltage	max. 30 V AC/DC
Operating current per contact	max. 2 A
Locking of ports	Screw thread M12 × 1 mm (recommended torque 0.6 Nm) self-securing

Protection	IP66K, IP67 inserted and tightened (EN 60529)
------------	---

Material	CuZn, nickel plated
----------	---------------------

Commercial data

country of origin	DE
-------------------	----

customs tariff number	85444290
-----------------------	----------

minimum order quantity	1
------------------------	---