

MQ15-X- Power female receptacle front mount

PVC 6x2,5 UL/CSA 0,5m

MQ15

Female

6-pole

Flange Connectors

Quick connection technology

Plastic housings with good resistance against chemicals and oils. The resistance to aggressive media should be individually tested for your application. Further details on request. Further cable lengths on request.

[Link to Product](#)

Illustration

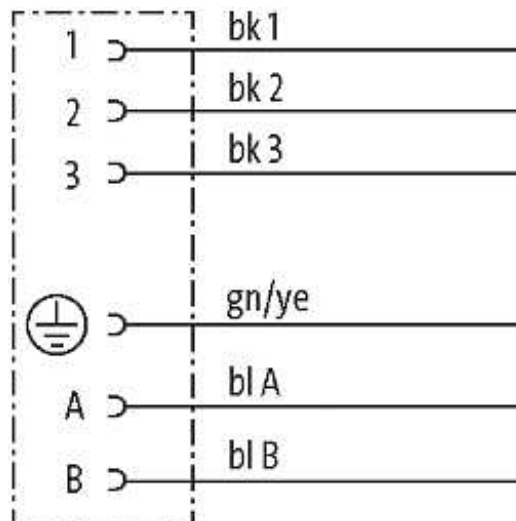

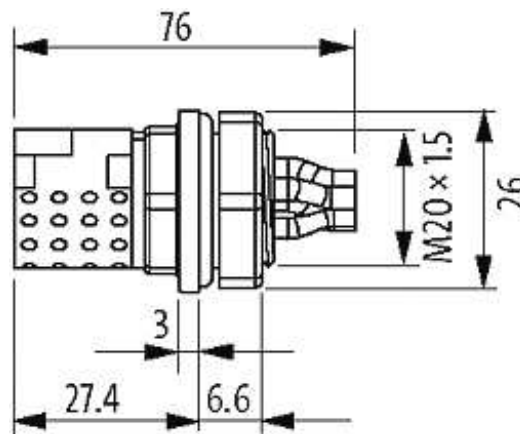
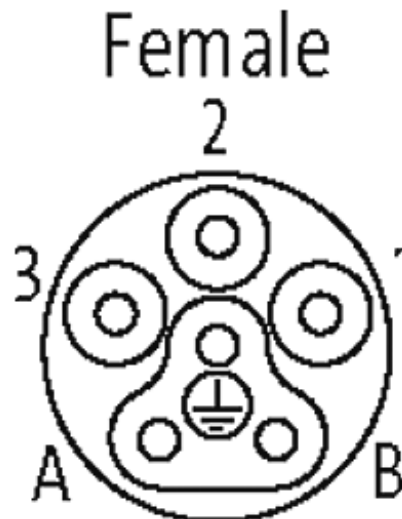

Product may differ from Image

Form

Form P8191

Cables

Cable number	P80
No./diameter of wires	6 × 2.5 mm ²
Wire isolation	PP (bk num, gnye)
C-track properties	5 Mio.
Torsion	± 15°/m
Shore hardness outer jacket	80 ± 5A
Outer Ø	approx. 3.6 mm
Bend radius (fixed)	5 × outer Ø
Bend radius (moving)	10 × outer Ø
Temperature range (fixed)	-40...+80 °C
Temperature range (mobile)	-20...+60 °C

Technical Data

Operating voltage	max. 600 V AC/DC
Operating voltage (Signal)	max. 63 V AC/DC (A, B)

Operating current per contact	max. 16 A
Operating current per contact (Signal)	max. 10 A (A, B)
Locking of ports	Quick connection, 1/4 turn
Protection	IP67 inserted and tightened (EN 60529)
Locking material	Polyamide

Commercial data

country of origin	DE
customs tariff number	85444290
minimum order quantity	1